



Page 7-4/5/8
7-20/21/24

BUTTON ACTUATORS Ø22mm

- Spring return flush, extended and shrouded
- Push-push flush and extended
- Mushroom-head
- Mechanical reset
- Illuminated.



Page 7-6 and 9
7-22 and 25

DOUBLE AND TRIPLE TOUCH ACTUATORS Ø22mm

- Double touch with or without indicator
- Triple touch.



Page 7-7 and 9
7-23 and 25

SELECTOR SWITCH ACTUATORS Ø22mm

- Knob
- Lever
- Key
- Illuminated.



Page 7-10 and 11

PILOT LIGHTS Ø22mm

- Monoblock LED

MONOBLOCK BUZZERS Ø22mm

- Pulse-tone.



Page 7-26

METAL POTENTIOMETER DRIVES Ø22mm

- Graduated scale
- Variable index.



Page 7-27

METAL JOYSTICKS Ø22mm

- 2 directions
- 4 directions
- 2 directions with mechanical interlock
- 4 directions with mechanical interlock
- Complete with auxiliary contacts.



Page 7-12 and 28

ADD-ON ELEMENTS, ACCESSORIES AND SPARE PARTS FOR PUSHBUTTONS AND SELECTOR SWITCHES

- Mounting adapter
- Contact elements
- Lamp holders
- LED integrated lamp holders
- Labelling and label holders
- Bulbs.



Page 7-36 and 37

CONTROL STATIONS

- 1 to 5 positions without actuators
- Complete units with 1 button.



- Simple and snap on installation
- Highly conductive contacts
- High degree of protection per IEC IP66, IP67, IP69K and UL type 4X
- Contact operation: double breaking action, direct opening operation and self cleaning.

Pushbuttons and selector switches Ø22mm/Ø0.87in - **PLatinum** series

SEC. - PAGE

Pushbutton actuators, spring return	7 - 4
Push-push button actuators	7 - 5
Mushroom-head push button actuators	7 - 5
Mechanical reset button, spring return	7 - 6
Double-touch button actuators, spring return	7 - 6
Triple-touch button actuators, spring return	7 - 6
Selector switch actuators	7 - 7
Illuminated button actuators, spring return	7 - 8
Illuminated push-push button actuators	7 - 8
Illuminated mushroom-head actuators	7 - 8
Double-touch button actuators, spring return, with indicator	7 - 9
Illuminated selector actuators	7 - 9
Pilot light heads	7 - 10
Monoblock LED pilot lights, steady light	7 - 10
Monoblock buzzers	7 - 11
Add-on elements and accessories	7 - 12

Pushbuttons and selectors Ø22mm/Ø0.87in - 8 LM metal series

Pushbutton actuators, spring return	7 - 20
Push push button actuators	7 - 21
Mushroom-head push button actuators	7 - 21
Mechanical reset button, spring return	7 - 22
Double-touch button actuators, spring return	7 - 22
Triple-touch button actuators, spring return	7 - 22
Selector switch actuators	7 - 23
Illuminated button actuators, spring return	7 - 24
Illuminated push-push actuators	7 - 24
Illuminated mushroom-head actuators	7 - 24
Double-touch button actuators, spring return, with indicator	7 - 25
Illuminated selector actuators	7 - 25
Pilot light heads	7 - 26
Potentiometers drives	7 - 26
Joysticks	7 - 27
Add-on elements and accessories	7 - 28

Control stations	7 - 36
-------------------------------	---------------

Dimensions	7 - 38
-------------------------	---------------

Wiring diagrams	7 - 43
------------------------------	---------------

QUALITY TOUCH!



- **LOW ACTUATOR PROFILE**
 The external actuator bezel has a low profile and reduced front thickness.



- **CUSTOMISING CAPABILITY**
 To simplify stock management, the new series allows quick replacement of the actuator cap or lens of spring return types since these are also sold as accessories.

- **HIGH DEGREE OF PROTECTION**
 IEC IP66, IP67, IP69K and UL TYPE 4X
 The actuators have been tested to ensure a degree of protection per IEC IP66, IP67, IP69K and UL type 4X, appropriate for use even in extreme ambient conditions.

7

● QUICK AND EASY ACTUATOR INSTALLATION



- Actuator fixing on the mounting surface, through a Ø22mm/Ø0.87in drilled hole, is obtained using its **threaded ring**, easily rotated by hand or by socket spanner/wrench.



- There is an **anti-rotation fastener**, duly sized to avoid actuator rotation on the mounting surface and to give an orientation reference point for users during panel installation and during contact fitting on the actuator.
- This anti-rotation fastener collapses inside the gasket to allow fitting also when drilled holes are round without reference index.
- The sealing gasket for the actuator mounting surface has a gripping action (suction effect) offering a surface prefixing property.



- The mounting adapter and the actuators each have **clearly visible reference** indications making the snap-on fitting between the two easy and intuitive.

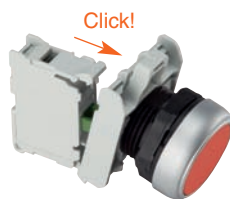

- Electrical contacts and LED lamp holders are **snapped onto** the mounting adapter.

● REDUCED DIMENSIONS AND INTERAXIS

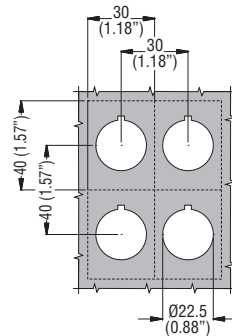

- The new series provides a minimum 30x40mm (1.18x1.57in) pitch between two actuators on a mounting surface.
- Minimum pitch between drilled holes for double and triple touch actuators is 30x55mm (1.18x1.97in).

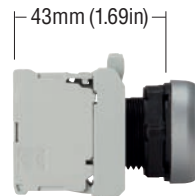

- Total depth, from the external mounting surface to the end of the first contact element is merely 43mm (1.69in).

● CONTACT ELEMENTS



- Miniaturised size
- High electric conductivity - 5V 1mA
- Up to 9 contact elements can be installed, 3 rows of 3 elements
- Screw or faston termination
- Contact operation: double breaking action, direct opening operation and self cleaning.

● HIGH-LUMINOSITY LED INTEGRATED LAMP HOLDERS



- Miniaturised size
- Long electrical life: 100,000h
- Over-voltage protection
- Withstand to vibrations
- Protection against stray currents in wiring
- Flickering phenomenon reduction
- Steady and flashing light versions
- Supply voltages:
 - 18-30VAC/DC
 - 85-140VAC
 - 185-265VAC.

- ELEGANT STYLE AND ERGONOMIC DESIGN**
 All the series elements have an ergonomic design and, at the same time, particular care has been given to minimum detail aesthetics.
- LONG ACTUATOR MECHANICAL LIFE**
 High performance characteristics assure 5,000,000 cycle mechanical life for spring-return actuators, 1,000,000 for double and triple touch units and 300,000 for emergency-stop types.
- MATERIALS RESISTENT TO OILS, SOLVENTS AND HYDROCARBONS**
 Developed and designed to respect international standards requirements.
- USAGE AT EXTREME TEMPERATURE CONDITIONS**
 Operation temperature range between -25° and +70°C.
- UL CERTIFICATION FOR USA AND CANADA.**



DOUBLE AND TRIPLE TOUCH ACTUATORS



- IEC IP66, IP67, IP69K and UL Type 4X degree of protection
- Double touch button actuators, with 2 flush or 1 flush and 1 extended buttons
- Triple touch button actuators with 2 flush and middle extended buttons
- Versions with or without indicator.

MECHANICAL RESET BUTTONS

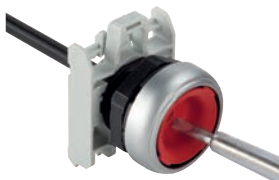

- Rod adjustment directly on acuator front (1...4mm / 0.04...0.16in)



- Up to 6 contact elements can be mounted.

EMERGENCY STOP ACTUATORS



- Actuator structure suitable to warrant direct opening operation with mechanical latching for emergency stopping per ISO 13850 and IEC/EN 60947-5-5.
- There is a green line around the actuator body to spot when the emergency stop is at rest or activated.
- Use of Ronis keys



- Various accessories available (e.g. yellow E-stop disks, padlockable protection and rubber actuator boots).

SELECTOR SWITCH ACTUATORS



- Knob design assures excellent grip



- High visibility on front or side and actuator inscription shows exact switch position



- Use of Ronis keys



- Activation of the centre contacts is standard-supplied on 2 and 3 position selector switches.

EXTENSIVE CHOICE OF ACCESSORIES



- Pilot light heads



- Monoblock LED-integrated pilot lights



- Monoblock buzzers



- Label holders and engravable blank labels.

Pushbutton actuators, spring return



LPC B10...



LPC B20...



LPC B30...



Order code	Colour	Qty per pkg n°	Wt [kg]
------------	--------	-------------------	------------

Flush (without mounting adapter). Spring return.

LPC B102	Black	10	0.025
LPC B103	Green	10	0.025
LPC B104	Red	10	0.025
LPC B105	Yellow	10	0.025
LPC B106	Blue	10	0.025
LPC B108	White	10	0.025

Extended (without mounting adapter). Spring return.

LPC B202	Black	10	0.027
LPC B203	Green	10	0.027
LPC B204	Red	10	0.027
LPC B205	Yellow	1	0.027
LPC B206	Blue	1	0.027
LPC B208	White	1	0.027

Shrouded (without mounting adapter). Spring return.

LPC B302	Black	10	0.027
LPC B303	Green	10	0.027
LPC B304	Red	10	0.027
LPC B305	Yellow	1	0.027
LPC B306	Blue	1	0.027
LPC B308	White	1	0.027

Pushbutton actuators, spring return, with symbol



LPC B11...



LPC B21...



Order code	Symbol	Colour	Qty per pkg n°	Wt [kg]
------------	--------	--------	-------------------	------------

Flush (without mounting adapter). Spring return.

LPC B1102	0	Black	10	0.025
LPC B1104		Red	10	0.025
LPC B1113	I	Green	10	0.025
LPC B1118		White	10	0.025
LPC B1123	II	Green	1	0.025
LPC B1128		White	1	0.025
LPC B1132	STOP	Black	1	0.025
LPC B1134		Red	10	0.025
LPC B1142	← ①	Black	10	0.025
LPC B1148		White	10	0.025
LPC B1152	↑ ②	Black	10	0.025
LPC B1158		White	10	0.025
LPC B1163	START	Green	10	0.025
LPC B1168		White	1	0.025
LPC B1176	R	Blue	1	0.025
LPC B1178		White	1	0.025
LPC B1196	RESET	Blue	10	0.025
LPC B1502	↔	Black	10	0.025
LPC B1512	↔	Black	10	0.025

Extended (without mounting adapter). Spring return.

LPC B2102	0	Black	10	0.027
LPC B2104		Red	10	0.027
LPC B2132	STOP	Black	1	0.027
LPC B2134		Red	10	0.027

① Arrow symbol can be used to indicate right or left.

② Arrow symbol can be used to indicate up or down.

Operational characteristics

- Ambient conditions:
 - Operating temperature: -25...+70°C
 - Storage temperature: -40...+85°C
- Any mounting position is allowed.
- Degree of protection:
 - Per IEC/EN: IP66, IP67 and IP69K
 - Per UL: type 1, 2, 3R, 4, 4X, 12, 12K.

Materials

Polyamide.

Mechanical endurance

Operating force: <0.5kg / 1.1lb (actuator).
Mechanical life: 5,000,000 cycles.

Mounting adapter

See page 7-12.

Type: LPX AU120.

Actuators are installed through a Ø22mm/Ø.89in drilling with a threaded fixing ring (Tmax = 2.3Nm / 1.69lbf).

The mounting adapter directly snaps onto the actuator.

Contact elements

See page 7-12.

Type: LPX C10 (1NO)
LPX CF10 (1NO Faston)
LPX C10A (1EM)
LPX C01 (1NC)
LPX CF01 (1NC Faston)
LPX C01D (1LB)

Contact elements snap onto the mounting adapter.

Up to 9 contact elements can be fitted on the mounting adapter: 3 on the left, 3 at the centre and 3 on the right; one on top of the other.

To mount contact elements in the centre position, use the accessory: LPX A140; see page 7-17.

Certifications and compliance

Certifications obtained: UL Listed, for USA and Canada, (File E93601), as Auxiliary Devices.
Certifications pending at time of catalogue printing: CCC.
Compliant with standards: IEC/EN 60947-1, IEC/EN 60947-5-1, UL508, CSA C22.2 n° 14.

Push-push button actuators



LPC Q10...

new



LPC Q20...

new

Order code	Colour	Qty per pkg	Wt
		n°	[kg]

Flush (without mounting adapter).
Push on-push off.

LPC Q1020	Black	10	0.025
LPC Q1030	Green	10	0.025
LPC Q1040	Red	10	0.025
LPC Q1050	Yellow	1	0.025
LPC Q1060	Blue	1	0.025
LPC Q1080	White	1	0.025

Extended (without mounting adapter).
Push on-push off.

LPC Q2020	Black	10	0.027
LPC Q2030	Green	10	0.027
LPC Q2040	Red	10	0.027
LPC Q2050	Yellow	1	0.027
LPC Q2060	Blue	1	0.027
LPC Q2080	White	1	0.027

Ⓢ Contact elements LPX C10 (NO) and LPX C01D (LB) cannot be fitted on these actuators.
Use contact elements LPX C10A (EM) and LPXC01 (NC) only.

Mushroom head push button actuators



LPC B614...

new



LPC B616...

new



LPC B674...

new



LPC B6634

new



LPC B6644

new



LPC B684...

new

Order code	Colour	Qty per pkg	Wt
		n°	[kg]

SPRING RETURN.
Ø40mm/1.6in (without mounting adapter).

LPC B6142	Black	10	0.033
LPC B6143	Green	10	0.033
LPC B6144	Red	10	0.033
LPC B6145	Yellow	10	0.033
LPC B6146	Blue	10	0.033

SPRING RETURN.
Ø60mm/2.4in (without mounting adapter).

LPC B6162	Black	10	0.038
LPC B6163	Green	10	0.038
LPC B6164	Red	10	0.038
LPC B6165	Yellow	10	0.038
LPC B6166	Blue	10	0.038

LATCH, PULL TO RELEASE
Ø40mm/1.6in (without mounting adapter).
For normal stopping.

LPC B6742	Black	10	0.097
LPC B6744	Red	10	0.097

For emergency stopping, ISO 13850 compliant.

LATCH, TURN TO RELEASE
Ø40mm/1.6in (without mounting adapter).
For normal stopping.

LPC B6342	Black	10	0.046
LPC B6344	Red	10	0.046

Ø30mm/1.2in (without mounting adapter).
For emergency stopping, ISO 13850 compliant.

LPC B6634	Red	10	0.079
-----------	-----	----	-------

Ø40mm/1.6in (without mounting adapter).
For emergency stopping, ISO 13850 compliant.

LPC B6644	Red	10	0.079
-----------	-----	----	-------

LATCH, TURN KEY TO RELEASE
Ø40mm/1.6in (without mounting adapter).
For normal stopping.

LPC B6842	Black	10	0.083
LPC B6842RⓈ	Black	1	0.083

For emergency stopping, ISO 13850 compliant.

LPC B6844	Red	10	0.083
LPC B6844RⓈ	Red	1	0.083

Ⓢ Versions with different key codes.
Complete with the numeric code of the key.
The following versions are available: 421E, 458A, 520E, 3131A, 3433E.
Example of complete code: LPC B6844R 421E.

Operational characteristics

- Ambient conditions:
 - Operating temperature: -25...+70°C
 - Storage temperature: -40...+85°C
- Any mounting position is allowed.
- Degree of protection:
 - Per IEC/EN: IP66, IP67 and IP69K
 - Per UL: type 1, 2, 3R, 4, 4X, 12, 12K.

Materials

Polyamide.

Mechanical endurance

Operating force: <0.5kg / 1.1lb (actuator).

Mechanical life:

- Push-push actuators: 500,000 cycles;
- Mushroom head buttons: 5,000,000 cycles;
- Mushroom head latch buttons: 300,000 cycles.

Mounting adapter

See page 7-12.

Type: LPX AU120.

Actuators are installed through a Ø22mm/Ø0.87in drilling with a threaded fixing ring (Tmax = 2.3Nm / 1.69lbf).
The mounting adapter directly snaps onto the actuator.

Contact elements for push-push button actuators

See page 7-12.

Type: LPX C10A (1EM)

LPX C01 (1NC)

Contact elements snap onto the mounting adapter.

Up to 6 contact elements can be fitted on the mounting adapter: 2 on the left, 2 at the centre and 2 on the right.

Contact elements for mushroom head spring return button actuators

See page 7-12.

Type: LPX C10 (1NO)

LPX CF10 (1NO Faston)

LPX C10A (1EM)

LPX C01 (1NC)

LPX CF01 (1NC Faston)

LPX C01D (1LB)

Contact elements snap onto the mounting adapter.

Up to 9 auxiliary contacts can be fitted on the mounting adapter: 3 on the left, 3 at the centre and 3 on the right.
To mount the contact elements in the centre position, use the accessory: LPX A140; see page 7-17.

Contact elements for mushroom head latch button actuators

See page 7-12.

Type: LPX C10 (1NO)

LPX CF10 (1NO Faston)

LPX C10A (1EM)

LPX C01 (1NC)

LPX CF01 (1NC Faston)

LPX C01D (1LB)

Contact elements snap onto the mounting adapter.

Up to 6 contact elements can be fitted on the mounting adapter: 2 on the left, 2 at the centre and 2 on the right.

Certifications and compliance

Certifications obtained: UL Listed, for USA and Canada (File E93601), as Auxiliary Devices.

Certifications pending at time of catalogue printing: CCC.

Compliant with standards: IEC/EN 60947-1, IEC/EN 60947-5-1, UL508, CSA C22.2 n° 14.

Mechanical reset buttons, complete unit, spring return



LPC R1196



Order code	Colour	Qty per pkg	Wt
		n°	[kg]
Flush (5.2mm/0.2" stroke). Adjustable length 0-150mm/5.9". Complete with shaft (without mounting adapter). Spring return.			
LPC R1002	Black	10	0.038
LPC R1003	Green	10	0.038
LPC R1004	Red	10	0.038
LPC R1006	Blue	10	0.038
LPC R1196	Blue (RESET)	10	0.038
Extended (5.2mm/0.2" stroke). Adjustable length 0-150mm/5.9". Complete with shaft (without mounting adapter). Spring return.			
LPC R2004	Red	1	0.040

① With "RESET" caption on actuator.

Operational characteristics

- Ambient conditions:
 - Operating temperature: -25...+70°C
 - Storage temperature: -40...+85°C
- Any mounting position is allowed.
- Degree of protection:
 - Per IEC/EN: IP66, IP67 and IP69K
 - Per UL: type 1, 2, 3R, 4, 4X, 12, 12K.

Materials

Polyamide.

Mechanical endurance

- Operating force: <0.5kg / 1.1lb (actuator).
Mechanical life:
- Mechanical reset buttons: 5,000,000 cycles
 - Double and triple-touch actuators: 1,000,000 cycles.

Mounting adapter

See page 7-12.
Type: LPX AU120.
Actuators are installed through a Ø22mm/Ø0.87in drilling with a threaded fixing ring (Tmax = 2.3Nm / 1.69lbf). The mounting adapter directly snaps onto the actuator.

Contact elements

See page 7-12.
Type: LPX C10 (1NO)
LPX CF10 (1NO Faston)
LPX C10A (1EM)
LPX C01 (1NC)
LPX CF01 (1NC Faston)
LPX C01D (1LB)

Contact elements snap onto the mounting adapter.

MECHANICAL RESET BUTTONS

Up to 6 contact elements can be fitted on the mounting adapter: 3 on the left and 3 on the right.

DOUBLE-TOUCH ACTUATORS

Up to 6 contact elements can be fitted on the mounting adapter: 3 on the left and 3 on the right.

TRIPLE-TOUCH ACTUATORS

Up to 9 contact elements can be fitted on the mounting adapter: 3 on the left, 3 at the centre and 3 on the right.

Certifications and compliance

Certifications obtained: UL Listed, for USA and Canada (File E93601), as Auxiliary Devices.
Certifications pending at time of catalogue printing: CCC.
Compliant with standards: IEC/EN 60947-1, IEC/EN 60947-5-1, UL508, CSA C22.2 n° 14.

7 Double-touch actuators, spring return



LPC B71...



Order code	Colour	Symbols	Qty per pkg	Wt
			n°	[kg]
Two flush push buttons (without mounting adapter). Both spring return.				
LPC B7112	Black/Red	—	5	0.030
LPC B7113	Green/Red	—	5	0.030
LPC B7114	White/Black	—	5	0.030
LPC B7122	Black/Red	I-O	5	0.030
LPC B7123	Green/Red	I-O	5	0.030
LPC B7124	White/Black	I-O	5	0.030
LPC B7133	Green/Red	Start/Stop	5	0.030

One extended and one flush push buttons (without mounting adapter). Both spring return.

LPC B7212	Black/Red	—	1	0.030
LPC B7213	Green/Red	—	5	0.030
LPC B7214	White/Black	—	1	0.030
LPC B7222	Black/Red	I-O	5	0.030
LPC B7223	Green/Red	I-O	5	0.030
LPC B7224	White/Black	I-O	1	0.030
LPC B7233	Green/Red	Start/Stop	5	0.030



LPC B72...



Triple-touch actuators, spring return



LPC B73...



Order code	Symbols	Qty per pkg	Wt
		n°	[kg]
Two external flush and one middle extended buttons (without mounting adapter). Spring return.			
LPC B7345		5	0.028
LPC B7355		5	0.028
LPC B7365		5	0.028
LPC B7375		5	0.028

Selector switch actuators knob



LPC S1...

new

Order code	Type of positions	Qty per pkg	Wt
		n°	[kg]
2 position (without mounting adapter).			
LPC S120		10	0.037
LPC S121		10	0.037
3 position (without mounting adapter).			
LPC S130		10	0.037
LPC S131		10	0.037
LPC S132		10	0.037
LPC S133		10	0.037

Selector switch actuators key



LPC S3...

new

Order code	Type of position	Qty per pkg	Wt
		n°	[kg]
2 position (without mounting adapter).			
LPC S320		10	0.060
LPC S320RⓈ		1	0.060
LPC S321		10	0.060
LPC S321RⓈ		1	0.060
LPC S340		10	0.060
LPC S340RⓈ		1	0.060
3 position (without mounting adapter).			
LPC S330		10	0.060
LPC S330RⓈ		1	0.060
LPC S331		10	0.060
LPC S331RⓈ		1	0.060
LPC S332Ⓢ		10	0.060
LPC S332RⓈⓈ		1	0.060
LPC S333Ⓢ		10	0.060
LPC S333RⓈⓈ		1	0.060
LPC S350		10	0.060
LPC S350RⓈ		1	0.060
LPC S360		10	0.060
LPC S360RⓈ		1	0.060
LPC S370Ⓢ		10	0.060
LPC S370RⓈⓈ		1	0.060
LPC S380Ⓢ		10	0.060
LPC S380RⓈⓈ		1	0.060
LPC S390Ⓢ		10	0.060
LPC S390RⓈⓈ		1	0.060

Ⓢ Versions with different key codes. Complete with the numeric code of the key. The following versions are available: 421E, 458A, 520E, 3131A, 3433E. Example of complete code: LPC S320R 421E.

Ⓢ Available only on specific request.

Contact activation of 2-position selector switch

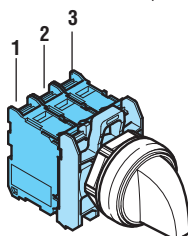

		Contacts		
		1	2	3
A		—	—	—
B		•	•	•

Contact activation of 3-position selector switch

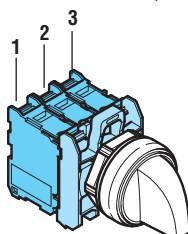

		Contacts		
		1	2	3
A		•	•	—
B		—	—	—
C		—	•	•

Operational characteristics

- Ambient conditions:
 - Operating temperature: -25...+70°C
 - Storage temperature: -40...+85°C
- Any mounting position is allowed.
- Degree of protection:
 - Per IEC/EN: IP66, IP67 and IP69K
 - Per UL: type 1, 2, 3R, 4, 4X, 12, 12K.

Materials

Polyamide.

Mechanical endurance

Mechanical life: 1,000,000 cycles.

Mounting adapter

See page 7-12.

Type: LPX AU120.

Actuators are installed through a Ø22mm/Ø0.87in drilling with a threaded fixing ring (Tmax = 2.3Nm / 1.69lbf). The mounting adapter directly snaps onto the actuator.

Contact elements

See page 7-12.

- Type:
- LPX C10 (1NO)
 - LPX CF10 (1NO Faston)
 - LPX C10A (1EM)
 - LPX C01 (1NC)
 - LPX CF01 (1NC Faston)
 - LPX C01D (1LB)

Contact elements snap onto the mounting adapter.

Up to 6 auxiliary contacts can be fitted on the mounting adapter: 3 on the left and 3 on the right or 2 on the left, 2 at the centre and 2 on the right.

Activation of the middle contacts is coupled to the side contacts; the relative mechanism is standard supplied. The middle contact activation, with respect to the right and left side contacts, can be changed by the user if required, by removing the mechanism pin.

Type of position

- Maintained position.
- Spring return position.
- Key extraction position.

Rotation angles

2 position



3 position



Special versions

Versions with coloured keys are available upon request. Consult Customer Service; see contact details on inside front cover.

Certifications and compliance

Certifications obtained: UL Listed, for USA and Canada (file E93601), as Auxiliary Devices. Certifications pending at time of catalogue printing: CCC. Compliant with standards: IEC/EN 60947-1, IEC/EN 60947-5-1, UL508, CSA C22.2 n° 14.

Illuminated button actuators, spring return



LPC BL10...



LPC BL20...



Order code	Colour	Qty per pkg n°	Wt [kg]
------------	--------	-------------------	------------

Flush (without mounting adapter).
Spring return.

LPC BL103	Green	10	0.025
LPC BL104	Red	10	0.025
LPC BL105	Yellow	10	0.025
LPC BL106	Blue	10	0.025
LPC BL107	Transparent	10	0.025

Extended (without mounting adapter). Spring return.

LPC BL203	Green	10	0.027
LPC BL204	Red	10	0.027
LPC BL205	Yellow	10	0.027
LPC BL206	Blue	10	0.027
LPC BL207	Transparent	10	0.027

Operational characteristics

- Ambient conditions:
 - Operating temperature: -25...+70°C
 - Storage temperature: -40...+85°C
- Any mounting position is allowed.
- Degree of protection:
 - Per IEC/EN: IP66, IP67 and IP69K
 - Per UL: type 1, 2, 3R, 4, 4X, 12, 12K.

Materials

Polyamide.

Mechanical endurance

Operating force: <0.5kg / 1.1lb (actuator).

Mechanical life:

- Spring-return actuators (flush, extended, mushroom head): 5,000,000 cycles
- Push-push actuators: 500,000 cycles
- Latch mushroom-head actuators: 300,000 cycles.

Mounting adapter

See page 7-12.

Type: LPX AU120.

Actuators are installed through a Ø22mm/Ø0.87in drilling with a threaded fixing ring (Tmax = 2.3Nm / 1.69lbf).

The mounting adapter directly snaps onto the actuator.

Contact elements for push-push button actuators

See page 7-12.

Type: LPX C10A (1EM)
LPX C01 (1NC)

Contact elements snap onto the mounting adapter.

Up to 4 contact elements can be fitted on the mounting adapter: 2 on the left and 2 on the right.

Contact elements for spring-return and latch type actuators

See page 7-12.

Type: LPX C10 (1NO)
LPX CF10 (1NO Faston)
LPX C10A (1EM)
LPX C01 (1NC)
LPX CF01 (1NC Faston)
LPX C01D (1LB)

Contact elements snap onto the mounting adapter.

On LPC BL1..., LPC BL2... and LPC BL61... types, up to 6 contact elements can be fitted of the mounting adapter: 3 on the left and 3 on the right.

On LPC BL66... types, up to 4 contact elements can be fitted on the mounting adapter: 2 on the left and 2 on the right.

LED integrated lamp holders

See page 7-13.

Certifications and compliance

Certifications obtained: UL Listed, for USA and Canada (File E93601), as Auxiliary Devices.

Certifications pending at time of catalogue printing: CCC.

Compliant with standards: IEC/EN 60947-1, IEC/EN 60947-5-1, UL508, CSA C22.2 n° 14.

7

Illuminated push-push button actuators



LPC QL10...



LPC QL20...



Order code	Colour	Qty per pkg n°	Wt [kg]
------------	--------	-------------------	------------

Flush (without mounting adapter).
Push on-push off.

LPC QL103	Green	10	0.025
LPC QL104	Red	10	0.025
LPC QL105	Yellow	10	0.025
LPC QL106	Blue	10	0.025
LPC QL107	Transparent	10	0.025

Extended (without mounting adapter).
Push on-push off.

LPC QL203	Green	10	0.027
LPC QL204	Red	10	0.027
LPC QL205	Yellow	10	0.027
LPC QL206	Blue	10	0.027
LPC QL207	Transparent	10	0.027

❶ Contact elements LPX C10 (NO) and LPX C01D (LB) cannot be fitted on these actuators.
Use contact elements LPX C10A (EM) and LPXC01 (NC) only.

Illuminated mushroom head button actuators



LPC BL614...



LPC BL664...



Order code	Colour	Qty per pkg n°	Wt [kg]
------------	--------	-------------------	------------

SPRING RETURN.
Ø40mm/1.6in (without mounting adapter).

LPC BL6143	Green	10	0.035
LPC BL6144	Red	10	0.035
LPC BL6145	Yellow	10	0.035
LPC BL6146	Blue	10	0.035
LPC BL6148	White	1	0.035

LATCH, TURN TO RELEASE.
Ø40mm/1.6in (without mounting adapter).
For normal stopping.

LPC BL6643	Green	1	0.040
LPC BL6645	Yellow	1	0.040
LPC BL6646	Blue	1	0.040

For emergency stopping, ISO 13850 compliant.

LPC BL6644	Red	10	0.040
------------	-----	----	-------

Double-touch actuators, spring return, white indicator



LPC BL71...



LPC BL72...



Order code	Colour	Symbol	Qty per pkg	Wt
			n°	[kg]

Two flush pushbuttons (without mounting adapter). Both spring return.

LPC BL7112	Black/Red	—	5	0.030
LPC BL7113	Green/Red	—	5	0.030
LPC BL7114	White/Black	—	1	0.030
LPC BL7122	Black/Red	I-O	5	0.030
LPC BL7123	Green/Red	I-O	5	0.030
LPC BL7124	White/Black	I-O	5	0.030
LPC BL7133	Green/Red	Start/Stop	5	0.030

One extended and one flush pushbuttons (without mounting adapter). Both spring return.

LPC BL7212	Black/Red	—	1	0.030
LPC BL7213	Green/Red	—	5	0.030
LPC BL7214	White/Black	—	1	0.030
LPC BL7222	Black/Red	I-O	1	0.030
LPC BL7223	Green/Red	I-O	5	0.030
LPC BL7224	White/Black	I-O	5	0.030
LPC BL7233	Green/Red	Start/Stop	5	0.030

Illuminated selector switch actuators



LPC SL1...



Order code	Colour	Type of positions	Qty per pkg	Wt
			n°	[kg]

2 position (without mounting adapter).

LPC SL1203	Green	✓	10	0.025
LPC SL1204	Red		10	0.025
LPC SL1205	Yellow		10	0.025
LPC SL1206	Blue		10	0.025
LPC SL1208	White		10	0.025
LPC SL1213	Green	⚡	10	0.025
LPC SL1214	Red		1	0.025
LPC SL1215	Yellow		1	0.025
LPC SL1216	Blue		1	0.025
LPC SL1218	White		10	0.025

3 position (without mounting adapter).

LPC SL1303	Green	✓	10	0.025
LPC SL1304	Red		1	0.025
LPC SL1305	Yellow		1	0.025
LPC SL1306	Blue		1	0.025
LPC SL1308	White	⚡	1	0.025
LPC SL1313	Green		10	0.025
LPC SL1314	Red		1	0.025
LPC SL1315	Yellow		1	0.025
LPC SL1316	Blue	⚡	1	0.025
LPC SL1318	White		1	0.025
LPC SL1323	Green		10	0.025
LPC SL1324	Red		1	0.025
LPC SL1325	Yellow	⚡	1	0.025
LPC SL1326	Blue		1	0.025
LPC SL1328	White		1	0.025
LPC SL1333	Green		10	0.025
LPC SL1334	Red	⚡	1	0.025
LPC SL1335	Yellow		1	0.025
LPC SL1336	Blue		1	0.025
LPC SL1338	White		10	0.025

Contact activation of 2-position selector switch

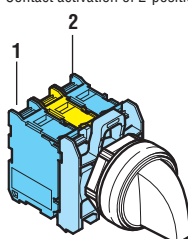

		Contacts	
		1	2
A		—	—
B		•	•

Operational characteristics

- Ambient conditions:
 - Operating temperature: -25...+70°C
 - Storage temperature: -40...+85°C
- Any mounting position is allowed.
- Degree of protection:
 - Per IEC/EN: IP66, IP67 and IP69K
 - Per UL: type 1, 2, 3R, 4, 4X, 12, 12K.

Materials

Polyamide.

Mechanical endurance

Operating force: <0.5kg / 1.1lb (actuator).

Mechanical life:

- Double-touch actuators: 1,000,000 cycles.
- Selector switches: 1,000,000 cycles.

Mounting adapter

See page 7-12.

Type: LPX AU120.

Actuators are installed through a Ø22mm/Ø0.87In drilling with a threaded fixing ring (Tmax = 2.3Nm / 1.69lbf).

The mounting adapter directly snaps onto the actuator.

Contact elements

See page 7-12.

Type:

- LPX C10 (1NO)
- LPX CF10 (1NO Faston)
- LPX C10A (1EM)
- LPX C01 (1NC)
- LPX CF01 (1NC Faston)
- LPX C01D (1LB)

Contact elements snap onto the mounting adapter.

DOUBLE-TOUCH ACTUATORS

Up to 6 contact elements can be fitted on the mounting adapter: 3 on the left and 3 on the right.

SELECTOR SWITCH ACTUATORS

On the 2 and 3-position illuminated selectors, up to 4 contact elements can be fitted on the mounting adapter: 2 on the left and 2 on the right.

Selector switch type of positions

✓ Maintained position.

⚡ Spring return position.

Selector switch rotation angles

2 position



3 position



Lamp-holder elements

See page 7-13.

Certifications and compliance

Certifications obtained: UL Listed, for USA and Canada (File E93601), as Auxiliary Devices
 Certifications pending at time of catalogue printing: CCC.
 Compliant with standards: IEC/EN 60947-1, IEC/EN 60947-5-1, UL508, CSA C22.2 n° 14.

Contact activation of 3-position selector switch

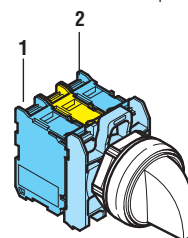

		Contacts	
		1	2
A		•	—
B		—	—
C		—	•

Pilot light heads



LPL...



Order code	Colour	Qty per pkg n°	Wt [kg]
Without mounting adapter.			
LPL 3	Green	10	0.024
LPL 4	Red	10	0.024
LPL 5	Yellow	10	0.024
LPL 6	Blue	10	0.024
LPL 7	Transparent	10	0.024
LPL 1187	Transparent ⚡	10	0.024

⚡ With symbol indicating dangerous voltage (IEC/EN 60417 5036-a).

Operational characteristics

- Ambient conditions:
 - Operating temperature: -25...+70°C
 - Storage temperature: -40...+85°C
- Any mounting position is allowed.
- Degree of protection:
 - Per IEC/EN: IP66, IP67 and IP69K
 - Per UL: type 1, 2, 3R, 4, 4X, 12, 12K.

Materials

Polyamide.

Mounting adapter

See page 7-12.

Type: LPX AU120.

Actuators are installed through a Ø22mm/Ø0.87in drilling with a threaded fixing ring (Tmax = 2.3Nm / 1.69lbf).

The mounting adapter directly snaps onto the actuator.

Lamp-holder elements

See page 7-13.

Certifications and compliance

Certifications obtained: UL Listed, for USA and Canada (File E93601), as Auxiliary Devices.

Certifications pending at time of catalogue printing: CCC.

Compliant with standards: IEC/EN 60947-1, IEC/EN 60947-5-1, UL508, CSA C22.2 n° 14.

LED integrated monoblock pilot lights steady light



8 LP2T IL...P



Order code	Rated auxiliary supply voltage	LED colour	Qty per pkg n°	Wt [kg]
Without mounting adapter.				
8 LP2T IL A3P	12VAC/DC	Green	10	0.021
8 LP2T IL A4P		Red	10	0.021
8 LP2T IL A5P		Yellow	10	0.021
8 LP2T IL A6P		Blue	10	0.021
8 LP2T IL A8P		Transparent	10	0.021
8 LP2T IL B3P	24VAC/DC	Green	10	0.021
8 LP2T IL B4P		Red	10	0.021
8 LP2T IL B5P		Yellow	10	0.021
8 LP2T IL B6P		Blue	10	0.021
8 LP2T IL B8P		Transparent	10	0.021
8 LP2T IL E3P	110VAC	Green	10	0.024
8 LP2T IL E4P		Red	10	0.024
8 LP2T IL E5P		Yellow	10	0.024
8 LP2T IL E6P		Blue	10	0.024
8 LP2T IL E8P		Transparent	10	0.024
8 LP2T IL M3P	230VAC	Green	10	0.024
8 LP2T IL M4P		Red	10	0.024
8 LP2T IL M5P		Yellow	10	0.024
8 LP2T IL M6P		Blue	10	0.024
8 LP2T IL M8P		Transparent	10	0.024

Operational characteristics

- Rated auxiliary supply voltage: 12VAC/DC, 24VAC/DC, 110VAC, 230VAC
- Electrical life: >30,000 hours
- Consumption: ≤20mA
- Screw termination
- Maximum tightening torque: 0.8Nm / 0.59lbf
- Side cable entry
- Ambient conditions:
 - Operating temperature: -5...+40°C
 - Degree of protection per IEC/EN:
 - IP65 on front;
 - IP20 at rear.

Materials

Polyamide and polycarbonate.

Maximum conductor cross section

1 or 2 1.5mm² or AWG16 cables.

Wiring diagram

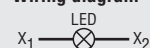

Certifications and compliance

Certifications obtained: UL Listed, for USA and Canada (File E93602), as Motor Controllers - Accessory, indicator.

Compliant with standards: IEC/EN 60947-1, IEC/EN 60947-5-1, UL508, CSA C22.2 n° 14.

Pulse-tone monoblock buzzers



8 LP2T ZG...

Order code	Voltage	Sound intensity at 2500Hz	Qty per pkg	Wt
	[V]	[dB]	n.	[kg]
Pulse-tone.				
8 LP2T ZGB	24VAC/DC	80dB ^①	10	0.020
8 LP2T ZGE	110VAC/DC		10	0.020
8 LP2T ZGM	230VAC		10	0.020

① Value measured at a distance of 10cm (3.94in).

Pulse-tone sound graph

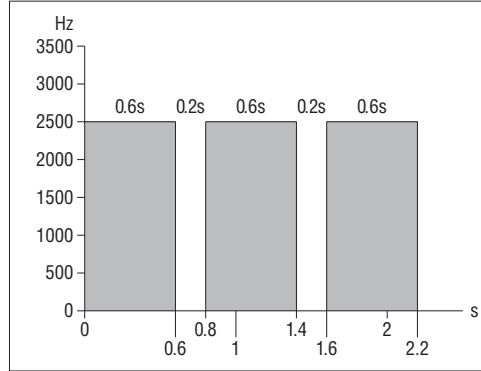

General characteristics

Monoblock buzzers are used as sound indicators in automation systems and on-board machinery in the production processes. Long life, low consumption values and compact size are the main features of this product.

Operational characteristics

- Rated auxiliary supply voltage: 24VAC/DC; 110VAC/DC; 230VAC
- Rated frequency: 50-60Hz
- Consumption: <20mA
- Service life: 30,000 hours (permanently powered)
- Screw termination
- Maximum tightening torque: 0.8Nm / 0.59lbf
- Side cable entry
- Ambient conditions:
 - Operational temperature: -25...+55°C
 - Storage temperature: -25...+55°C
 - Degree of protection per IEC/EN:
 - IP40 on front;
 - IP20 at rear.

Materials

Polyamide and polycarbonate.

Maximum conductor cross section

1 or 2 2.5mm² or AWG12 cables.

Wiring diagram

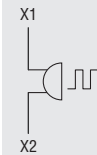

Reference standards

Compliant with standards: IEC/EN 60947-1, IEC/EN 60947-5-1, IEC/EN 61000-6-1, IEC/EN 61000-6-3.

Mounting adapter



LPX AU120

new

Order code	Description	Qty per pkg	Wt [kg]
LPX AU120	Mounting adapter	10	0.019

Contact elements

7



LPX C...

new

Order code	Function	Qty per pkg	Wt [kg]
	All SPST	n°	[kg]

Screw termination.
Without mounting adapter.

LPX C10Ⓢ	1.3 1.4 NOⓈ	10	0.011
LPX C10A	1.7 1.8 EMⓈ	10	0.011
LPX C01⊖	1.1 1.2 NCⓈ	10	0.011
LPX C01DⓈ⊖	1.5 1.6 LBⓈⓈ	10	0.011

Screw termination.
With mounting adapter.

new

LPX E10Ⓢ	1.3 1.4 NOⓈ	10	0.029
LPX E01⊖	1.1 1.2 NCⓈ	10	0.029

LPX E...

new

LPX CF10Ⓢ	1.3 1.4 NOⓈ	10	0.012
LPX CF01⊖	1.1 1.2 NCⓈ	10	0.012



LPX CF01 LPX CF10

- Ⓢ Not suitable for push-push actuators. Use LPX C10A (EM) or LPX C01 (NC) type only with push-push actuators.
- Ⓢ Normally open contact with early make operation.
- ⊖ Direct opening operation in accordance with IEC/EN 60947-5-1.
- ⓈⓈ Normally closed contact with late break operation.

Operational characteristics

- Ambient conditions:
 - Operating temperature: -25...+70°C
 - Storage temperature: -40...+85°C
- Any mounting position is allowed.
- Degree of protection per IEC/EN:
 - IP20 for contacts elements with screw termination
 - IP00 for contact elements with Faston termination.
- Tightening torque: 1Nm/0.74lbf max (except Faston).

General characteristics of contact elements

Self cleaning, dual scraping-oscillating action
IEC rated insulation voltage: 690V
IEC rated thermal current Ith: 10A
Conductivity: 5V 1mA
UL/CSA and IEC/EN 60947-5-1 designation: A600 Q600.

IEC operational power in AC15:

[V]	12	24	48	120	240	400	480	500	600
[A]	6	6	6	6	3	1.9	1.5	1.4	1.2

IEC operational power in DC13:

[V]	12	24	48	125	250	440	500	600
[A]	3	3	1.5	0.55	0.27	0.15	0.13	0.1

Short-circuit protection fuse: max calibre 10A gG/SC.

Contact resistance: ≤20mΩ.

Terminals: Clamp screw with washer
Faston 1-6.35mm(0.25in) or 2-2.8mm (0.11in).

Stroke of contact elements

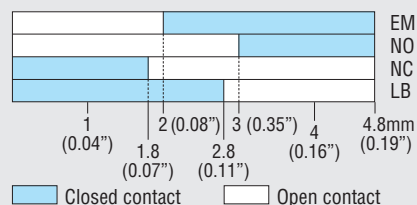

Maximum conductor cross section for screw terminals
1 or 2 2.5mm² or AWG14 cables.

Mechanical and electrical endurance

Operating force: ≤0.5kg / 1.1lb (auxiliary contacts).

Electrical life:	LPX C10	1,000,000 cycles
	LPX CF10	1,000,000 cycles
	LPX C01	1,000,000 cycles
	LPX CF01	1,000,000 cycles
	LPX C10A	600,000 cycles
	LPX C01D	600,000 cycles.

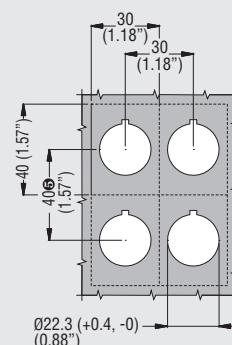

Ⓢ When using Faston, pitch is 85mm / 3.35in minimum.

Certifications and compliance

Certifications obtained: UL Listed, for USA and Canada (File E93601), as Auxiliary Devices.
Certifications pending at time of catalogue printing: CCC.
Compliant with standards: IEC/EN 60947-1, IEC/EN 60947-5-1, UL508, CSA C22.2 n° 14.

LED integrated lamp-holders steady or flashing light



LPX L...



Order code	Rated auxiliary supply voltage	LED colour	Qty per pkg	Wt
	[V]		n°	[kg]

Steady light.
Protected version.
Supplied without mounting adapter.

LPX LP B3	18-30V AC/DC	Green	10	0.016
LPX LP B4		Red	10	0.016
LPX LP B5		Yellow	10	0.016
LPX LP B6		Blue	10	0.016
LPX LP B8		White	10	0.016
LPX LP E3	85-140VAC	Green	10	0.016
LPX LP E4		Red	10	0.016
LPX LP E5		Yellow	10	0.016
LPX LP E6		Blue	10	0.016
LPX LP E8		White	10	0.016
LPX LP M3	185-265VAC	Green	10	0.016
LPX LP M4		Red	10	0.016
LPX LP M5		Yellow	10	0.016
LPX LP M6		Blue	10	0.016
LPX LP M8		White	10	0.016

Steady light.
Non-protected version.
Supplied without mounting adapter.

LPX LE B3	18-30V AC/DC	Green	10	0.016
LPX LE B4		Red	10	0.016
LPX LE B5		Yellow	10	0.016
LPX LE B6		Blue	10	0.016
LPX LE B8		White	10	0.016
LPX LE E3	85-140V AC/DC	Green	10	0.016
LPX LE E4		Red	10	0.016
LPX LE E5		Yellow	10	0.016
LPX LE E6		Blue	10	0.016
LPX LE E8		White	10	0.016
LPX LE M3	185-265V AC/DC	Green	10	0.016
LPX LE M4		Red	10	0.016
LPX LE M5		Yellow	10	0.016
LPX LE M6		Blue	10	0.016
LPX LE M8		White	10	0.016

Flashing light.
Protected version.
Supplied without mounting adapter.

LPX LF B3	18-30V AC/DC	Green	10	0.016
LPX LF B4		Red	10	0.016
LPX LF B5		Yellow	10	0.016
LPX LF B6		Blue	10	0.016
LPX LF B8		White	10	0.016
LPX LF E3	85-140VAC	Green	10	0.016
LPX LF E4		Red	10	0.016
LPX LF E5		Yellow	10	0.016
LPX LF E6		Blue	10	0.016
LPX LF E8		White	10	0.016
LPX LF M3	185-265VAC	Green	10	0.016
LPX LF M4		Red	10	0.016
LPX LF M5		Yellow	10	0.016
LPX LF M6		Blue	10	0.016
LPX LF M8		White	10	0.016

Operational characteristics

- Rated auxiliary supply voltage for:
 - Protected steady light: 18-30VAC/DC; 85-140VAC; 185-265VAC
 - Non-protected steady light: 18-30VAC/DC; 85-140VAC/DC; 185-265VAC/DC
 - Protected flashing light: 18-30VAC/DC; 85-140VAC; 185-265VAC
- Maximum consumption for:
 - Protected steady light: 17mA (18-30VAC/DC) 20mA (85-140VAC) 17mA (185-265VAC)
 - Non-protected steady light: 11mA (18-30VAC/DC) 5mA (85-140VAC/DC) 3mA (185-265VAC/DC)
 - Protected flashing light: 17mA (18-30VAC/DC) 20mA (85-140VAC) 17mA (185-265VAC)
- Protected version features consist of:
 - Over voltage protection
 - Withstand to vibrations
 - Protection against stray currents in wiring
 - Flickering phenomenon reduction
- Electrical life: 100,000 hours
- Ambient conditions:
 - Operating temperature: -25...+70°C (-25...+60°C for LPX LE...)
 - Storage temperature: -40...+85°C
- Any mounting position is allowed.
- Degree of protection per IEC/EN: IP20
- Maximum tightening torque: 1Nm / 0.74lbf.

Maximum conductor cross section

1 ø 2.5mm² or AWG12 cables.

Wiring diagram



Certifications and compliance

Certifications obtained: UL listed, for USA and Canada (File E93601), as Auxiliary Devices.
Certifications pending at time of catalogue printing: CCC.
Compliant with standards: IEC/EN 60947-1, IEC/EN 60947-5-1, UL508, CSA C22.2 n° 14.

Accessories and spare parts



LPX AU100

new



LPX AU105

new



LPX AU108
LPX AU109

new



LPX AU158

new

Order code	Description	Qty	Wt
		per pkg n°	[kg]
LPX AU100	Label holder for blank or engraved plastic LPX AU109 labels	50	0.001
LPX AU109	Engravable silver plastic label to use with LPX AU100 holder	50	0.002
LPX AU105	Label holder for blank or engraved LPX AU108 label	50	0.003
LPX AU108	Engravable silver plastic label to use with LPX AU105 holder	50	0.002
LPX AU13 ^②	Rubber boot for flush and illuminated flush pushbuttons	10	0.006
LPX AU14 ^②	Rubber boot for extended and illuminated extended pushbuttons	10	0.009
LPX AU157	Rubber boot for double and triple-touch buttons, transparent	10	0.007
LPX AU167 ^{②③}	Rubber boot for mushroom head buttons, transparent	10	0.012
LPX AU158 ^{②④}	Padlockable protection, Ø6-8mm/0.24-0.31in locks for latch e-stop buttons (except LPC B634...)	10	0.005

① For flush and extended push buttons, complete the order code by adding the digit of the required colour: 2 (black); 3 (green); 4 (red); 5 (yellow); 6 (blue); 7 (transparent); 8 (white). For illuminated push buttons, add only digit 7 (transparent).

② Cannot be used when LPX AU100 or LPX AU105 is fitted.

③ Cannot be used when LPX AU158 is fitted.

④ Cannot be used when LPX AU167 is fitted.

Labels with text for LPX AU100 legend holder



8 LM2T AGB230

Ordering code	Text	Qty per pkg n°	Wt [kg]
General use.			
8 LM2T AU206	Blank for writing	50	0.001
8 LM2T AU207	Sheet with 108 labels for laser printing ^①	1 ^②	0.005
8 LM2T AU208 ^③	Sheet with 108 laser-printed labels ^①	1 ^②	0.005
8 LM2T AGB216	CLOSE	50	0.001
8 LM2T AGB220	EMERGENCY	50	0.001
8 LM2T AGB231	FAST	50	0.001
8 LM2T AGB263	FAULT	50	0.001
8 LM2T AGB215	FORWARD	50	0.001
8 LM2T AGB228	LEFT	50	0.001
8 LM2T AGB218	LOWER	50	0.001
8 LM2T AGB221	OFF	50	0.001
8 LM2T AGB223	ON	50	0.001
8 LM2T AGB211	OPEN	50	0.001
8 LM2T AGB229	POWER ON	50	0.001
8 LM2T AGB227	RAISE	50	0.001
8 LM2T AGB226	RESET	50	0.001
8 LM2T AGB222	REVERSE	50	0.001
8 LM2T AGB217	RIGHT	50	0.001
8 LM2T AGB241	RUNNING	50	0.001
8 LM2T AGB224	SLOW	50	0.001
8 LM2T AGB225	START	50	0.001
8 LM2T AGB230	STOP	50	0.001
8 LM2T AGB214	STOP RESET	50	0.001
8 LM2T AGB240	THERMAL FAULT	50	0.001
8 LM2T AGB237	TRIP	50	0.001
For selector switches.			
8 LM2T AI233	AUTO-MAN	50	0.001
8 LM2T AI234	AUTO-O-MAN	50	0.001
8 LM2T AI241	MAN-AUTO	50	0.001
8 LM2T AI242	MAN-O-AUTO	50	0.001
8 LM2T AGB235	FWD-O-REV	50	0.001
8 LM2T AGB236	OFF-ON	50	0.001
8 LM2T AGB232	STOP-START	50	0.001
International labels for push-buttons.			
8 LM2T AU200	O	50	0.001
8 LM2T AU201	I	50	0.001
8 LM2T AU202	II	50	0.001
International labels for selector switches.			
8 LM2T AU203	O-I	50	0.001
8 LM2T AU204	I-II	50	0.001
8 LM2T AU205	I-O-II	50	0.001

① Recommended use with LM2T AU206 blank label.

② Sheet with 108 adhesive labels.

③ Complete code with label text required.

General characteristics

The labels have indelible scratch-proof black lettering on metalised grey polycarbonate background (adhesive).

Special versions

Labels in different languages are available.

Consult Customer Service; see contact details on inside front cover.

Plastic disk for mushroom head pushbuttons



LPX AU113

new



LPX AU115

Order code	Text	Qty	Wt
		per pkg n°	[kg]
LPX AU113	EMERGENCY/STOP Ø90mm / 3.5in	10	0.005
LPX AU115	EMERGENCY/STOP Ø60mm / 2.4in	10	0.003
LPX AU118	ARRET D'URGENCE / NOT-AUS/ PARO EMERGENCIA Ø60mm / 2.4in	10	0.003
LPX AU110	EMERGENCY STOP adhesive label, size 34.5x65mm/1.36x2.56in	10	0.001

General characteristics

The disks are made of non-adhesive plastic except LPX AU110. Plastic disks cannot be used with LPX AU158 padlockable protection.

Accessories and spare parts



LPX A140



LPX B104



LPX B203



LPX BL105



LPX BL206

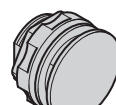

8 LM2T A130

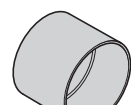

8 LM2T A185

Order code	Description	Qty per pkg	Wt
		n°	[kg]
LPX A127	Transparent diffuser for double-touch buttons	10	0.001
LPX A140	Action plug for centre contact	50	0.001
LPX A150	Rod for mechanical reset button (l=150mm/5.91in)	10	0.006
LPX A170	Spare standard key set for selector switches or mushroom-head buttons	10	0.008
LPX A170R [ⓐ]	Spare key set for selector switches or mushroom head buttons, LPC.. R type	1	0.008

Flush cap for spring-return actuators.

LPX B102	Black	10	0.002
LPX B103	Green	10	0.002
LPX B104	Red	10	0.002
LPX B105	Yellow	10	0.002
LPX B106	Blue	10	0.002
LPX B108	White	10	0.002

Extended cap for spring-return actuators.

LPX B202	Black	10	0.003
LPX B203	Green	10	0.003
LPX B204	Red	10	0.003
LPX B205	Yellow	10	0.003
LPX B206	Blue	10	0.003
LPX B208	White	10	0.003

Flush lens for illuminated spring-return actuators.

LPX BL103	Green	10	0.002
LPX BL104	Red	10	0.002
LPX BL105	Yellow	10	0.002
LPX BL106	Blue	10	0.002
LPX BL108	White	10	0.002

Extended lens for illuminated spring-return actuators.

LPX BL203	Green	10	0.003
LPX BL204	Red	10	0.003
LPX BL205	Yellow	10	0.003
LPX BL206	Blue	10	0.003
LPX BL208	White	10	0.003

[ⓐ] Versions with different key code. Complete with the numeric code of the key. The following versions are available: 421E, 458A, 520E, 3131A, 3433E. Example of complete code: LPX A170R421E.

Order code	Description	Qty per pkg	Wt
		n°	[kg]
8 LM2T A130	Threaded plug for unused drilled holes	10	0.007
8 LM2T A161	Ø30mm/1.2in hole size adapter set for 22mm/0.87in (use 2 per hole)	10	0.002
8 LM2T A185	Selector protection shroud for knob type only	10	0.004
8 LM2T A200	Socket spanner/wrench for fixing ring fitting	1	0.184

COMBINATIONS FOR PUSHBUTTONS AND SELECTOR SWITCHES

SPRING-RETURN BUTTONS

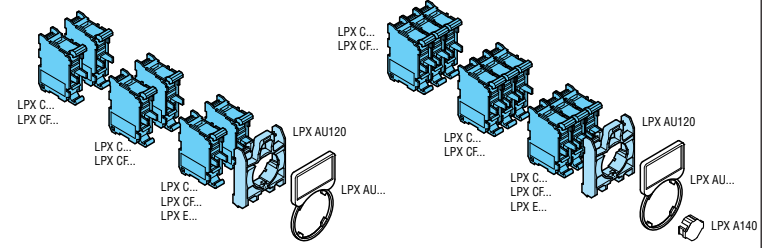

PUSH-PUSH BUTTONS

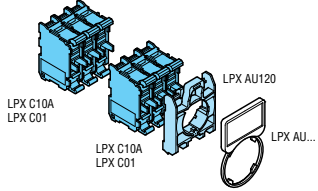
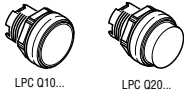

MUSHROOM-HEAD SPRING-RETURN BUTTONS

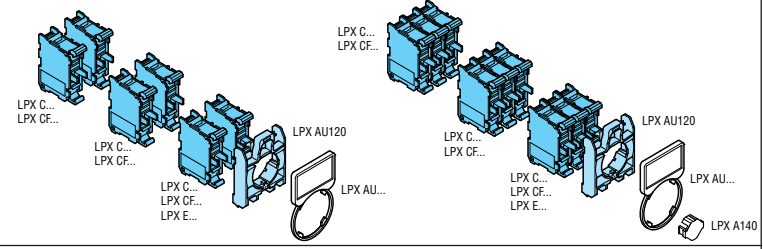
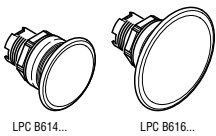

MUSHROOM-HEAD LATCH BUTTONS

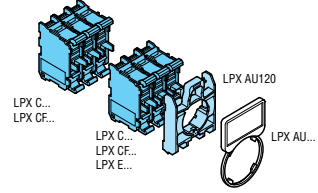
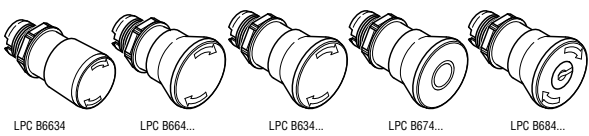

DOUBLE-TOUCH BUTTONS

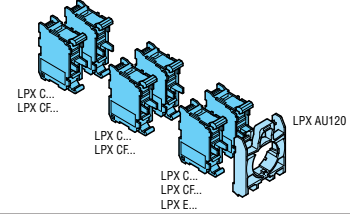
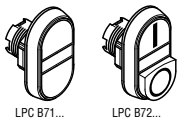

TRIPLE-TOUCH BUTTONS

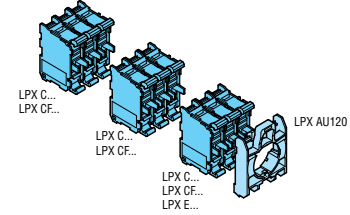

SELECTOR SWITCHES

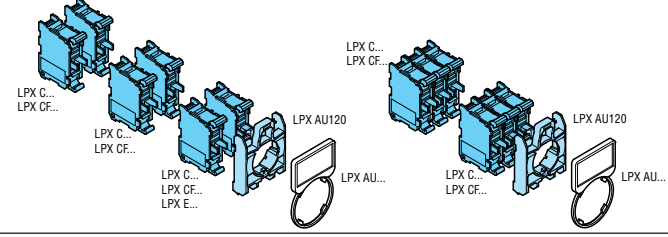
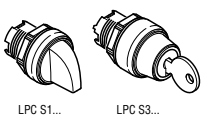

MECHANICAL SPRING-RETURN RESET BUTTONS

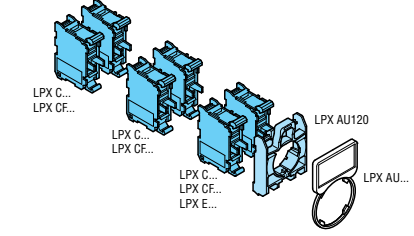
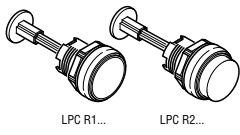

COMBINATIONS FOR ILLUMINATED PUSHBUTTONS AND SELECTOR SWITCHES

SPRING-RETURN BUTTONS

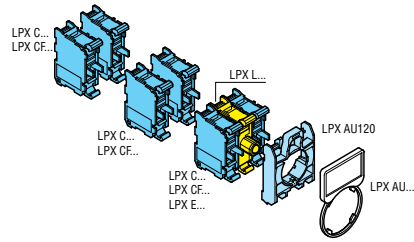
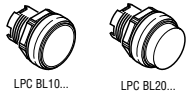

PUSH-PUSH BUTTONS

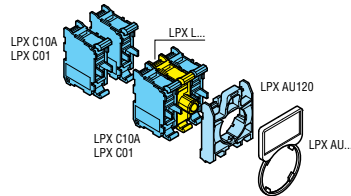
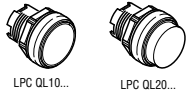

MUSHROOM-HEAD SPRING-RETURN BUTTON

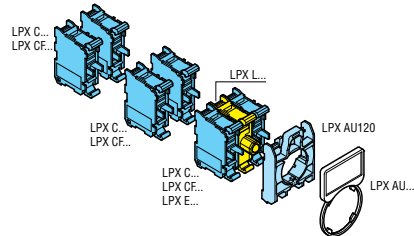

MUSHROOM-HEAD LATCH BUTTON

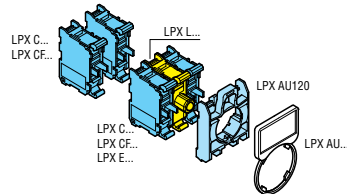
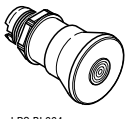

DOUBLE-TOUCH BUTTONS

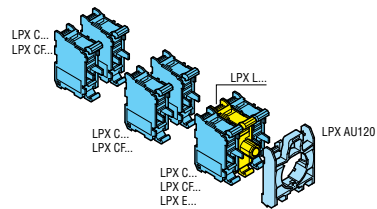
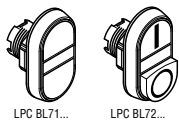

2-POSITION SELECTOR SWITCHES

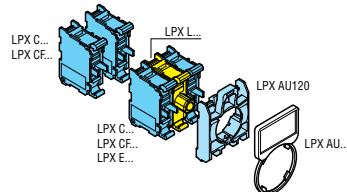

3-POSITION SELECTOR SWITCHES

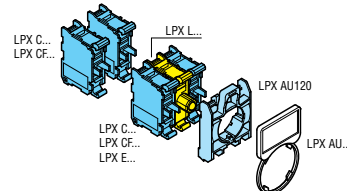
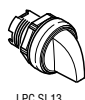

Pushbutton actuators, spring return



8 LM2T B10...



8 LM2T B20...



8 LM2T B30...

Order code	Colour	Qty per pkg	Wt
		n°	[kg]

Flush (without mounting adapter). Spring return.

8 LM2T B102	Black	10	0.033
8 LM2T B103	Green	10	0.033
8 LM2T B104	Red	10	0.033
8 LM2T B105	Yellow	10	0.033
8 LM2T B106	Blue	10	0.033
8 LM2T B108	White	10	0.033

Extended (without mounting adapter). Spring return.

8 LM2T B202	Black	10	0.035
8 LM2T B203	Green	10	0.035
8 LM2T B204	Red	10	0.035
8 LM2T B205	Yellow	10	0.035
8 LM2T B206	Blue	10	0.035
8 LM2T B208	White	10	0.035

Shrouded (without mounting adapter). Spring return.

8 LM2T B302	Black	10	0.035
8 LM2T B303	Green	10	0.035
8 LM2T B304	Red	10	0.035
8 LM2T B305	Yellow	10	0.035
8 LM2T B306	Blue	10	0.035
8 LM2T B308	White	10	0.035

Pushbutton actuators, spring return, with symbol



8 LM2T B11...



8 LM2T B21...

Order code	Symbol	Colour	Qty per pkg	Wt
			n°	[kg]

Flush (without mounting adapter). Spring return.

8 LM2T B1102	O	Black	10	0.033
8 LM2T B1104		Red	10	0.033
8 LM2T B1113	I	Green	10	0.033
8 LM2T B1118		White	10	0.033
8 LM2T B1123	II	Green	10	0.033
8 LM2T B1128		White	10	0.033
8 LM2T B1132	STOP	Black	10	0.033
8 LM2T B1134		Red	10	0.033
8 LM2T B1142	← ①	Black	10	0.033
8 LM2T B1148		White	10	0.033
8 LM2T B1152	↑ ②	Black	10	0.033
8 LM2T B1158		White	10	0.033
8 LM2T B1163	START	Green	10	0.033
8 LM2T B1168		White	10	0.033
8 LM2T B1176	R	Blue	10	0.033
8 LM2T B1178		White	10	0.033
8 LM2T B1196	RESET	Blue	10	0.033
8 LM2T B1502	↔	Black	10	0.033
8 LM2T B1512	↔	Black	10	0.033

Extended (without mounting adapter). Spring return.

8 LM2T B2102	O	Black	10	0.035
8 LM2T B2104		Red	10	0.035
8 LM2T B2132	STOP	Black	10	0.035
8 LM2T B2134		Red	10	0.035

① Arrow symbol can be used to indicate right or left.
 ② Arrow symbol can be used to indicate up or down.

Operational characteristics

- Ambient conditions:
 - Operating temperature: -25...+60°C
 - Storage temperature: -40...+70°C
- Any mounting position is allowed.
- Degree of protection:
 - Per IEC/EN: IP65
 - Per UL: type 1, 2, 3R, 4, 4X, 12, 12K.

Materials

An aluminium and zinc alloy (zama) is used for the metal part whereas plastic parts are made of polyamide and polycarbonate.

Mechanical endurance

Operating force: 0.8kg / 1.71b (actuator).
 Mechanical life: 1,000,000 cycles.

Mounting adapter

See page 7-28.

Type: LM2T AU120.

Actuators latch onto the mounting adapter by simple rotation.

The adapter is fixed to the mounting surface by means of incorporated screws (Tmax = 0.8Nm / 0.59lbf).

Contact elements

See page 7-28.

- Type:
- LM2T C10 (1NO)
 - LM2T CF10 (1NO Faston)
 - LM2T C10A (1EM)
 - LM2T C01 (1NC)
 - LM2T CF01 (1NC Faston)
 - LM2T C01D (1LB)

Contact elements snap onto the mounting adapter.

Up to 6 contact elements can be fitted on the mounting adapter: 2 on the left, 2 at the centre and 2 on the right.

To mount the contact elements in the centre position, use the accessory: LM2T A140; see page 7-33.

Certifications and compliance

Certifications obtained: RINA, LROS, GOST, CCC, UL Listed, for USA and Canada (File E93601), as Auxiliary Devices.

Compliant with standards: IEC/EN 60947-1, IEC/EN 60947-5-1, UL508, CSA C22.2 n° 14.

Push-push button actuators



8 LM2T Q10...



8 LM2T Q20...

Order code	Colour	Qty per pkg n°	Wt [kg]
------------	--------	-------------------	------------

Flush (without mounting adapter). Push on-push off.

8 LM2T Q102Ⓢ	Black	10	0.033
8 LM2T Q103Ⓢ	Green	10	0.033
8 LM2T Q104Ⓢ	Red	10	0.033
8 LM2T Q105Ⓢ	Yellow	10	0.033
8 LM2T Q106Ⓢ	Blue	10	0.033
8 LM2T Q108Ⓢ	White	10	0.033

Extended (without mounting adapter). Push on-push off.

8 LM2T Q202Ⓢ	Black	10	0.035
8 LM2T Q203Ⓢ	Green	10	0.035
8 LM2T Q204Ⓢ	Red	10	0.035
8 LM2T Q205Ⓢ	Yellow	10	0.035
8 LM2T Q206Ⓢ	Blue	10	0.035
8 LM2T Q208Ⓢ	White	10	0.035

Ⓢ Contact elements NO (8LM2T C10) and LB (8LM2T C01D) cannot be fitted on these actuators.
Use contact elements EM (8 LM2T C10A) and NC (8LM2T C01) only.

Mushroom head pushbutton actuators



8 LM2T B614...



8 LM2T B616...

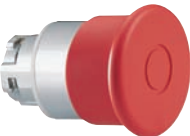

8 LM2T B624...



8 LM2T B634...



8 LM2T B654...



8 LM2T B654...

Order code	Colour	Qty per pkg n°	Wt [kg]
------------	--------	-------------------	------------

SPRING RETURN.
Ø40mm/1.6in (without mounting adapter).

8 LM2T B6142	Black	10	0.037
8 LM2T B6143	Green	10	0.037
8 LM2T B6144	Red	10	0.037
8 LM2T B6145	Yellow	10	0.037
8 LM2T B6146	Blue	10	0.037

SPRING RETURN.
Ø60mm/2.4in (without mounting adapter).

8 LM2T B6162	Black	10	0.043
8 LM2T B6163	Green	10	0.043
8 LM2T B6164	Red	10	0.043
8 LM2T B6165	Yellow	10	0.043
8 LM2T B6166	Blue	10	0.043

LATCH, PULL TO RELEASE.
Ø40mm/1.6in (without mounting adapter).
For normal stopping.

8 LM2T B6242	Black	10	0.105
8 LM2T B6244	Red	10	0.105

LATCH, TURN TO RELEASE.
Ø40mm/1.6in (without mounting adapter).
For normal stopping.

8 LM2T B6342	Black	10	0.054
8 LM2T B6344	Red	10	0.054

LATCH, TURN TO RELEASE.
Ø40mm/1.6in (without mounting adapter).
For emergency stopping, ISO 13850 compliant.

8 LM2T B6644	Red	10	0.087
--------------	-----	----	-------

LATCH, TURN KEY TO RELEASE.
Ø40mm/1.6in (without mounting adapter).
For normal stopping.

8 LM2T B6542	Black	10	0.091
8 LM2T B6542GⓈ		1	0.091
8 LM2T B6544	Red	10	0.091
8 LM2T B6544GⓈ		1	0.091

Ⓢ Versions with different key codes.
Complete with the numeric code of the key. The following versions are available: 501, 502, 503, 504, 505, 506, 507, 508, 509, 510.
Example of complete code: 8 LM2T B6542G505.

Operational characteristics

- Ambient conditions:
 - Operating temperature: -25...+60°C
 - Storage temperature: -40...+70°C
- Any mounting position is allowed.
- Degree of protection:
 - Per IEC/EN: IP65 for push-push and LM2T B654 actuators; IP66 for others.
 - Per UL: type 1, 2, 3R, 4, 4X, 12, 12K except for 8 LM2T B616 which is type 1, 2, 3R, 12, 12K.

Materials

An aluminium and zinc alloy (zama) is used for the metal part whereas plastic parts are made of polyamide and polycarbonate.

Mechanical endurance

Operating force: 0.8kg / 1.7lb (actuator).

Mechanical life:

- Push-push actuators: 500,000 cycles
- Mushroom head buttons: 1,000,000 cycles
- Mushroom head latch buttons: 300,000 cycles.

Mounting adapter

See page 7-28.

Type: LM2T AU120.

Actuators latch onto the mounting adapter by simple rotation.

The adapter is fixed to the mounting surface by means of incorporated screws (Tmax = 0.8Nm/0.59lbf).

Contact elements for push-push button actuators

See page 7-28.

Type: LM2T C10A (1EM)

LM2T C01 (1NC)

Contact elements snap onto the mounting adapter.

Up to 2 contact elements can be fitted on the mounting adapter: 1 each on the right and left.

Contact elements for spring-return mushroom-head button actuators

See page 7-28.

Type: LM2T C10 (1NO)

LM2T CF10 (1NO Faston)

LM2T C10A (1EM)

LM2T C01 (1NC)

LM2T CF01 (1NC Faston)

LM2T C01D (1LB)

Contact elements snap onto the mounting adapter.

Up to 6 contact elements can be fitted on the mounting adapter with all the other types: 2 on the left, 2 at the centre 2 on the right. To mount the contact elements in the centre position, use the accessory LM2T A140; see page 7-33.

Contact elements for latch mushroom-head button actuators

See page 7-28.

Type: LM2T C10 (1NO)

LM2T CF10 (1NO Faston)

LM2T C10A (1EM)

LM2T C01 (1NC)

LM2T CF01 (1NC Faston)

LM2T C01D (1LB)

Contact elements snap onto the mounting adapter.

Up to 6 contact elements can be fitted on the mounting adapter for all the other types: 2 on the left, 2 at the centre 2 on the right; for LM2T B624... and LM2T B6644 a maximum of 4 contacts only can be installed.

Certifications and compliance

Certifications obtained: RINA, LROS, GOST, CCC, UL Listed, for USA and Canada (File E93601), as Auxiliary Devices.

Compliant with standards: IEC/EN 60947-1, IEC/EN 60947-5-1, UL508, CSA C22.2 n° 14.

Mechanical reset button, complete unit, spring return



8 LM2T R1196

Order code	Colour	Qty per pkg	Wt
		n°	[kg]

Flush (5.2mm/0.2" stroke). Adjustable length 0-140mm/5.5". Spring return (complete with shaft and mounting adapter).

8 LM2T R1002	Black	10	0.065
8 LM2T R1003	Green	10	0.065
8 LM2T R1004	Red	10	0.065
8 LM2T R1006	Blue	10	0.065
8 LM2T R1196	Blue (RESET)	10	0.065

Extended (5.2mm/0.2" stroke). Adjustable length 0-140mm/5.5". Spring return (complete with shaft and mounting adapter).

8 LM2T R2004	Red	10	0.067
--------------	-----	----	-------

① With "RESET" caption on actuator.

Operational characteristics

- Ambient conditions:
 - Operating temperature: -25...+60°C
 - Storage temperature: -40...+70°C
- Any mounting position is allowed.
- Degree of protection:
 - Per IEC/EN: IP65 for mechanical reset buttons; IP40 for double and triple-touch actuators.
 - Per UL: type 1, 2, 3R, 4, 4X, 12, 12K for 8 LM2T R...; type 1 for 8 LM2T B71... and 8 LM2T B72...

Materials

An aluminium and zinc alloy (zama) is used for the metal part whereas plastic parts are made of polyamide and polycarbonate.

Mechanical endurance

Operating force: 0.8kg / 1.7lb (actuator)
Mechanical life: 1,000,000 cycles.

Mounting adapter

See page 7-28.

Type: LM2T AU120.

Actuators latch onto the mounting adapter by simple rotation.

The adapter is fixed to the mounting surface by means of incorporated screws (Tmax = 0.8Nm/0.59lbf).

Contact elements for double and triple-touch actuators

See page 7-28.

Type: LM2T C10 (1NO)
LM2T CF10 (1NO Faston)
LM2T C10A (EM)
LM2T C01 (1NC)
LM2T CF01 (1NC Faston)
LM2T C01D (LB)

Contact elements snap onto the mounting adapter.

DOUBLE-TOUCH ACTUATORS

Up to 4 contact elements can be fitted on the mounting adapter: 2 on the left and 2 on the right.

TRIPLE-TOUCH ACTUATORS

Up to 6 contact elements can be fitted on the mounting adapter: 2 on the left, 2 in the centre and 2 on the right.

Certifications and compliance

Certifications obtained: RINA, LROS, GOST, CCC, UL Listed, for USA and Canada (File E93601), as Auxiliary Devices.

Compliant with standards: IEC/EN 60947-1, IEC/EN 60947-5-1, UL508, CSA C22.2 n° 14.

7 Double-touch actuators, spring return



8 LM2T B71...



8 LM2T B72...

Order code	Colour	Symbols	Qty per pkg	Wt
			n°	[kg]

Two flush push-buttons (without mounting adapter). Both spring return.

8 LM2T B7112	Black/Red	none	5	0.044
8 LM2T B7113	Green/Red	none	5	0.044
8 LM2T B7114	White/Black	none	5	0.044
8 LM2T B7122	Black/Red	I-O	5	0.044
8 LM2T B7123	Green/Red	I-O	5	0.044
8 LM2T B7124	White/Black	I-O	5	0.044
8 LM2T B7133	Green/Red	Start/Stop	5	0.044

One extended and one flush push-buttons (without mounting adapter). Both spring return.

8 LM2T B7212	Black/Red	none	5	0.044
8 LM2T B7213	Green/Red	none	5	0.044
8 LM2T B7214	White/Black	none	5	0.044
8 LM2T B7222	Black/Red	I-O	5	0.044
8 LM2T B7223	Green/Red	I-O	5	0.044
8 LM2T B7224	White/Black	I-O	5	0.044
8 LM2T B7233	Green/Red	Start/Stop	5	0.044

Triple-touch actuators, spring return



8 LM2T B73...

Order code	Symbols	Qty per pkg	Wt
		n°	[kg]

Two external flush and one middle extended buttons (without mounting adapter). All spring return.

8 LM2T B7345	 STOP 	5	0.044
8 LM2T B7355	↑ STOP ↓	5	0.044
8 LM2T B7365	→ STOP ←	5	0.044
8 LM2T B7375	↗ STOP ↖	5	0.044

Selector switch actuators knob



8 LM2T S1...

Order code	Type of position	Qty per pkg	Wt
		n°	[kg]
2 position (without mounting adapter).			
8 LM2T S120		10	0.049
8 LM2T S121		10	0.049
3 position (without mounting adapter).			
8 LM2T S130		10	0.049
8 LM2T S131		10	0.049
8 LM2T S132		10	0.049
8 LM2T S133		10	0.049

Selector switch actuators lever



8 LM2T S2...

Order code	Type of position	Qty per pkg	Wt
		n°	[kg]
2 position (without mounting adapter).			
8 LM2T S220		10	0.050
8 LM2T S221		10	0.050
3 position (without mounting adapter).			
8 LM2T S230		10	0.050
8 LM2T S231		10	0.050
8 LM2T S232		10	0.050
8 LM2T S233		10	0.050

Selector switch actuators key



8 LM2T S3...

Order code	Type of position	Qty per pkg	Wt
		n°	[kg]
2 position (without mounting adapter).			
8 LM2T S320		10	0.079
8 LM2T S320G⓪		1	0.079
8 LM2T S321		10	0.079
8 LM2T S321G⓪		1	0.079
8 LM2T S340		10	0.079
8 LM2T S340G⓪		1	0.079
3 position (without mounting adapter).			
8 LM2T S330		10	0.080
8 LM2T S330G⓪		1	0.080
8 LM2T S331		10	0.080
8 LM2T S331G⓪		1	0.080
8 LM2T S332⓪		10	0.080
8 LM2T S332G⓪⓪		1	0.080
8 LM2T S333⓪		10	0.080
8 LM2T S333G⓪⓪		1	0.080
8 LM2T S350		10	0.080
8 LM2T S350G⓪		1	0.080
8 LM2T S360		10	0.080
8 LM2T S360G⓪		1	0.080
8 LM2T S370⓪		10	0.080
8 LM2T S370G⓪⓪		1	0.080
8 LM2T S380⓪		10	0.080
8 LM2T S380G⓪⓪		1	0.080
8 LM2T S390⓪		10	0.080
8 LM2T S390G⓪⓪		1	0.080

Operational characteristics

- Ambient conditions:
 - Operating temperature: -25...+60°C
 - Storage temperature: -40...+70°C
- Any mounting position is allowed.
- Degree of protection:
 - Per IEC/EN: IP65
 - Per UL: type 1, 2, 3R, 4, 4X, 12, 12K.

Materials

An aluminium and zinc alloy (zama) is used for the metal part whereas plastic parts are made of polyamide and polycarbonate.

Mechanical endurance

Mechanical life: 300,000 cycles.

Mounting adapter

See page 7-28.

Type: LM2T AU120.

Actuators latch onto the mounting adapter by simple rotation.

The adapter is fixed to the mounting surface by means of incorporated screws (Tmax = 0.8Nm / 0.59in).

Contact elements

See page 7-28.

- Type:
- LM2T C10 (1NO)
 - LM2T CF10 (1NO Faston)
 - LM2T C10A (1EM)
 - LM2T C01 (1NC)
 - LM2T CF01 (1NC Faston)
 - LM2T C01D (1LB)

Contact elements snap onto the mounting adapter.

Up to 4 contact elements can be fitted on the mounting adapter: 2 on the left and 2 on the right. For more, consult Customer Service for advice; see contact details on inside front cover.

Type of positions

- Maintained position.
- Spring return position.
- Key extraction position.

Rotation angles

2 position



3 position



Special versions

Versions with coloured keys are available upon request. Contact our Customer Service (Tel. +39 035 4282422; email: service@LovatoElectric.com).

Certifications and compliance

Certifications obtained: RINA, LROS, GOST, CCC, UL Listed, for USA and Canada (File E93601), as Auxiliary Devices.

Compliant with standards: IEC/EN 60947-1, IEC/EN 60947-5-1, UL508, CSA C22.2 n° 14.

- ⓪ Versions with different key codes. Complete with the numeric code of the key. The following versions are available: 501, 502, 503, 504, 505, 506, 507, 508, 509, 510. Example of complete code: 8 LM2T S320G505.
- ⓪ Available only on specific request.

Contact activation for 2-position selector switch

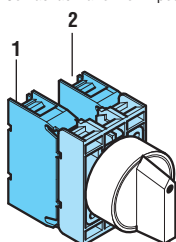

	Contacts	
	1	2
A		
B		

Contact activation of 3-position selector switch

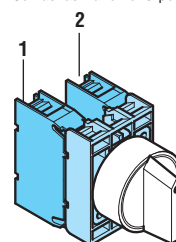

	Contacts	
	1	2
A		
B		
C		

Illuminated button actuators, spring return



8 LM2T BL10...



8 LM2T BL20...

Order code	Colour	Qty per pkg	Wt
		n°	[kg]

Flush with side visibility (without mounting adapter).
Spring return.

8 LM2T BL103	Green	10	0.033
8 LM2T BL104	Red	10	0.033
8 LM2T BL105	Yellow	10	0.033
8 LM2T BL106	Blue	10	0.033
8 LM2T BL107	Transparent	10	0.033

Extended (without mounting adapter). Spring return.

8 LM2T BL203	Green	10	0.035
8 LM2T BL204	Red	10	0.035
8 LM2T BL205	Yellow	10	0.035
8 LM2T BL206	Blue	10	0.035
8 LM2T BL207	Transparent	10	0.035

Operational characteristics

- Ambient conditions:
 - Operating temperature: -25...+60°C
 - Storage temperature: -40...+70°C
- Any mounting position is allowed.
- Degree of protection:
 - Per IEC/EN: IP65
 - Per UL: type 1, 2, 3R, 4, 4X, 12, 12K.

Materials

An aluminium and zinc alloy (zama) is used for the metal part whereas plastic parts are made of polyamide and polycarbonate.

Mechanical endurance

- Operating force: 0.8kg / 1.7lb (actuator).
Mechanical life:
- Spring return buttons: 1,000,000 cycles
 - Push-push buttons: 500,000 cycles.

Mounting adapter

See page 7-28.

Type: LM2T AU120.

Actuators latch onto the mounting adapter by simple rotation.

The adapter is fixed to the mounting surface by means of incorporated screws (Tmax = 0.8Nm/0.59lbf).

Contact elements for illuminated push-push actuators:

See page 7-28.

Type: LM2T C10A (EM)
LM2T C01 (1NC)

Contact elements snap onto the mounting adapter.

Up to 2 contact elements can be fitted on the mounting adapter in a row, 1 each on the right and left, along with the lamp-holder in the centre position, of which LM2T DL400, LM2T EL400, LM2T VL230, LM2T ZL230, LM2T L... or LM2T M... (see page 7-35).

With lamp-holder LM2T XL..., LM2T YL..., LM2T FL... or LM2T GL..., one only contact element can be mounted; see page 7-35.

Contact elements for illuminated spring-return button and mushroom-head actuators:

See page 7-28.

Type: LM2T C10 (1NO)
LM2T CF10 (1NO Faston)
LM2T C10A (EM)
LM2T C01 (1NC)
LM2T CF01 (1NC Faston)
LM2T C01D (LB)

Contact elements snap onto the mounting adapter.

On LM2T BL1, LM2T BL2 or LM2T BL61 actuators, the following can be fitted on the mounting adapter:

- Up to 4 contacts, 2 each on the left and right, when one of the following lamp-holders is used: LM2T DL400, LM2T EL400, LM2T VL230, LM2T ZL230, LM2T L or LM2T M (see page 7-35).
- Up to 2 contacts, one on top of the other of the same type only, when one of the following lamp-holders is used: LM2T XL, LM2T YL, LM2T FL or LM2T GL (see page 7-35).

On LM2T BL62... actuator, the following can be fitted on the mounting adapter:

- Up to 2 contacts, 1 each on the right and left, when one of the following lamp-holders is used: LM2T DL400, LM2T EL400, LM2T VL230, LM2T ZL230, LM2T L or LM2T M (see page 7-35)
- Up to 2 contacts, one on top of the other of the same type only, when one of the following lamp-holders is used: LM2T XL, LM2T YL, LM2T FL or LM2T GL (see page 7-35).

Lamp-holder elements

See page 7-29 and 30.

Lamps

Maximum recommended power: 1.2W.
See page 7-33.

Certifications and compliance

Certifications obtained: RINA, LROS, GOST, CCC, UL Listed, for USA and Canada (File E93601), as Auxiliary Devices.

Compliant with standards: IEC/EN 60947-1, IEC/EN 60947-5-1, UL508, CSA C22.2 n° 14.

Push-push button actuators



8 LM2T QL10...



8 LM2T QL20...

Order code	Colour	Qty per pkg	Wt
		n°	[kg]

Flush with side visibility (without mounting adapter).
Push on-push off.

8 LM2T QL103	Green	10	0.033
8 LM2T QL104	Red	10	0.033
8 LM2T QL105	Yellow	10	0.033
8 LM2T QL106	Blue	10	0.033
8 LM2T QL107	Transparent	10	0.033

Extended (without mounting adapter).
Push on-push off.

8 LM2T QL203	Green	10	0.035
8 LM2T QL204	Red	10	0.035
8 LM2T QL205	Yellow	10	0.035
8 LM2T QL206	Blue	10	0.035
8 LM2T QL207	Transparent	10	0.035

- ① Use only the early-make type, LM2T C10A.
No normally open contact element, LM2T C10, must be used with this type of button actuators.
A maximum of 2 contact elements can be mounted only.

Illuminated mushroom head button actuators



8 LM2T BL614...



8 LM2T BL624...

Order code	Colour	Qty per pkg	Wt
		n°	[kg]

SPRING RETURN.
Ø40mm (without mounting adapter).

8 LM2T BL6143	Green	10	0.043
8 LM2T BL6144	Red	10	0.043
8 LM2T BL6145	Yellow	10	0.043
8 LM2T BL6146	Blue	10	0.043
8 LM2T BL6148	White	10	0.043

LATCH, PULL TO RELEASE.
Ø40mm (without mounting adapter).

8 LM2T BL6243	Green	10	0.105
8 LM2T BL6244	Red	10	0.105
8 LM2T BL6245	Yellow	10	0.105
8 LM2T BL6246	Blue	10	0.105
8 LM2T BL6248	White	10	0.105

Double touch actuators, spring return, white indicator

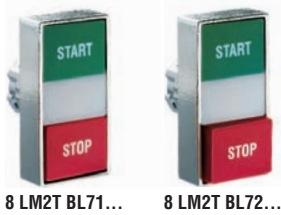

Order code	Colour	Symbol	Qty per pkg n°	Wt [kg]
------------	--------	--------	-------------------	------------

Two flush pushbuttons (without mounting adapter). Both spring return.

8 LM2T BL7112	Black/Red	none	5	0.044
8 LM2T BL7113	Green/Red	none	5	0.044
8 LM2T BL7114	White/Black	none	5	0.044
8 LM2T BL7122	Black/Red	I-O	5	0.044
8 LM2T BL7123	Green/Red	I-O	5	0.044
8 LM2T BL7124	White/Black	I-O	5	0.044
8 LM2T BL7133	Green/Red	Start/Stop	5	0.044

One extended and one flush pushbuttons (without mounting adapter). Both spring return.

8 LM2T BL7212	Black/Red	—	5	0.044
8 LM2T BL7213	Green/Red	—	5	0.044
8 LM2T BL7214	White/Black	—	5	0.044
8 LM2T BL7222	Black/Red	I-O	5	0.044
8 LM2T BL7223	Green/Red	I-O	5	0.044
8 LM2T BL7224	White/Black	I-O	5	0.044
8 LM2T BL7233	Green/Red	Start/Stop	5	0.044

Illuminated selector switch actuators



8 LM2T SL1...

Order code	Colour	Type of positions	Qty per pkg n°	Wt [kg]
------------	--------	-------------------	-------------------	------------

2 position (without mounting adapter).

8 LM2T SL1203	Green	✓	10	0.025
8 LM2T SL1204	Red		10	0.025
8 LM2T SL1205	Yellow		10	0.025
8 LM2T SL1206	Blue		10	0.025
8 LM2T SL1208	White		10	0.025
8 LM2T SL1213	Green	∩	10	0.025
8 LM2T SL1214	Red		10	0.025
8 LM2T SL1215	Yellow		10	0.025
8 LM2T SL1216	Blue		10	0.025
8 LM2T SL1218	White		10	0.025

3 position (without mounting adapter).

8 LM2T SL1303	Green	∇	10	0.025
8 LM2T SL1304	Red		10	0.025
8 LM2T SL1305	Yellow		10	0.025
8 LM2T SL1306	Blue		10	0.025
8 LM2T SL1308	White	∩	10	0.025
8 LM2T SL1313	Green		10	0.025
8 LM2T SL1314	Red		10	0.025
8 LM2T SL1315	Yellow		10	0.025
8 LM2T SL1316	Blue		10	0.025
8 LM2T SL1318	White		10	0.025
8 LM2T SL1323	Green	∇	10	0.025
8 LM2T SL1324	Red		10	0.025
8 LM2T SL1325	Yellow		10	0.025
8 LM2T SL1326	Blue		10	0.025
8 LM2T SL1328	White	∩	10	0.025
8 LM2T SL1333	Green		10	0.025
8 LM2T SL1334	Red		10	0.025
8 LM2T SL1335	Yellow		10	0.025
8 LM2T SL1336	Blue		10	0.025
8 LM2T SL1338	White		10	0.025

Contact activation of 2-position selector switch

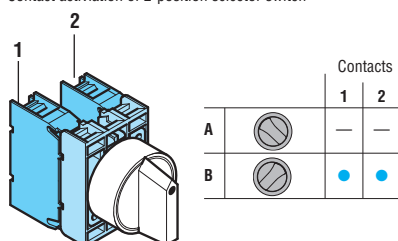

Contact activation of 3-position selector switch

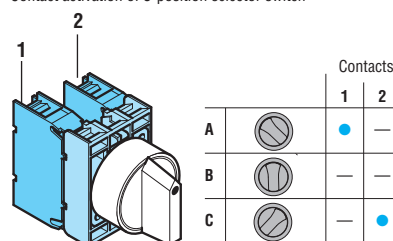

Operational characteristics

- Ambient conditions:
 - Operating temperature: -25...+60°C
 - Storage temperature: -40...+70°C
- Any mounting position is allowed.
- Degree of protection:
 - Per IEC/EN: IP65 for selectors; IP40 for double-touch actuators.
 - Per UL: type 1, 2, 3R, 4, 4X, 12, 12K except for 8 LM2T BL71... and 8 LM2T BL72... which are type 1.

Materials

An aluminium and zinc alloy (zama) is used for the metal part whereas plastic parts are made of polyamide and polycarbonate.

Mechanical endurance

- Operating force: 0.8kg / 1.7lb (double touch actuator).
Mechanical life:
- double-touch actuators: 1,000,000 cycles;
 - selector switches: 300,000 cycles.

Mounting adapter

See page 7-28.
Type: LM2T AU120.
Actuators latch onto the mounting adapter by simple rotation.
The adapter is fixed to the mounting surface by means of incorporated screws (Tmax = 0.8Nm/0.59lbf).

Contact elements

See page 7-28.
Type: LM2T C10 (1NO)
LM2T CF10 (1NO Faston)
LM2T C10A (1EM)
LM2T C01 (1NC)
LM2T CF01 (1NC Faston)
LM2T C01D (1LB)

Contact elements snap onto the mounting adapter.

DOUBLE-TOUCH ACTUATORS

Up to 4 contact elements can be fitted on the mounting adapter: 2 on the left and 2 on the right.

SELECTOR SWITCH ACTUATORS

On 2 or 3-position illuminated selectors, the following can be fitted on the mounting adapter:

- Up to 4 contact elements when the following types of lamp-holders are used: LM2T DL400, LM2T VL230, LM2T EL400, LM2T ZL230, LM2T L... or LM2T M... (see page 7-35).
- Up to 2 contact elements when the following types of lamp-holders are used: LM2T XL..., LM2T YL..., LM2T FL... or LM2T GL... (see page 7-35).

On 3-position illuminated selectors, the following can be fitted on the mounting adapter:

- Up to 4 contact elements when the following types of lamp-holders are used: LM2T DL400, LM2T VL230, LM2T EL400, LM2T ZL230, LM2T L... or LM2T M... (see page 7-35).

NOTE: The following lamp-holders cannot be mounted: LM2T XL..., LM2T YL..., LM2T FL... or LM2T GL...

Selector switch type of positions

- ✓ Maintained position.
- ∩ Spring return position.

Selector switch rotation angles

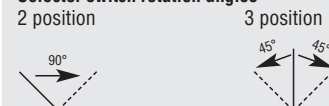

Lamp-holder elements

See page 7-29 and 30.

Lamps

Maximum recommended power: 1.2W.
See page 7-33.

Certifications and compliance

Certifications obtained: RINA, LROS, GOST, CCC, UL Listed, for USA and Canada (File E93601), as Auxiliary Devices.
Compliant with standards: IEC/EN 60947-1, IEC/EN 60947-5-1, UL508, CSA C22.2 n° 14.

Pilot light heads



8 LM2T IL10...

Order code	Colour	Qty per pkg	Wt
		n°	[kg]
Without mounting adapter.			
8 LM2T IL103	Green	10	0.024
8 LM2T IL104	Red	10	0.024
8 LM2T IL105	Yellow	10	0.024
8 LM2T IL106	Blue	10	0.024
8 LM2T IL107	Transparent	10	0.024
8 LM2T IL1187	Transparent ⚡	10	0.024

⚡ With symbol indicating dangerous voltage (IEC/EN 60417 5036-a).

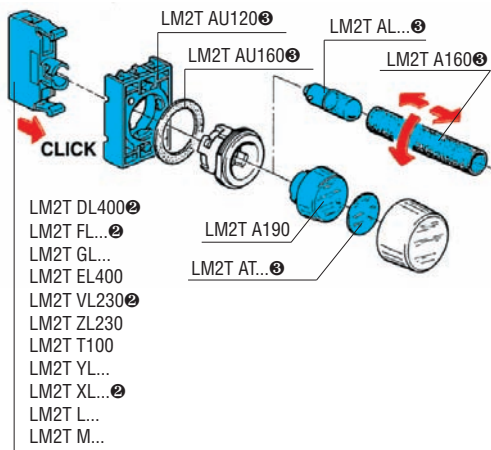

② The mounting adapter is standard supplied so there is no need to purchase it as a separate accessory.
 ③ Can be purchased separately. Refer to page 7-33.

Operational characteristics

- Ambient conditions:
 - Operating temperature: -25...+60°C
 - Storage temperature: -40...+70°C
- Any mounting position is allowed.
- Degree of protection:
 - Per IEC/EN: IP65
 - Per UL: type 1, 2, 3R, 4, 4X, 12, 12K.

Materials

An aluminium and zinc alloy (zama) is used for the metal part whereas plastic parts are made of polyamide and polycarbonate.

Mounting adapter

See page 7-28.
 Type: LM2T AU120.
 Actuators latch onto the mounting adapter by simple rotation.
 The adapter is fixed to the mounting surface by means of incorporated screws (Tmax = 0.8Nm/0.59lbf).

Lamp-holder elements

See page 7-29 and 30.

Lamps

Maximum recommended power: 1.2W.
 See page 7-33.

Certifications and compliance

Certifications obtained: RINA, LROS, GOST, CCC, UL Listed, for USA and Canada (File E93601), as Auxiliary Devices.
 Compliant with standards: IEC/EN 60947-1, IEC/EN 60947-5-1, UL508, CSA C22.2 n° 14.

Potentiometer drives



8 LM2T P100
(complete with mounting adapter)



8 LM2T P110
(complete with mounting adapter)

Order code	Characteristics	Qty per pkg	Wt
		n°	[kg]
8 LM2T P100④	With graduated scale	10	0,070
8 LM2T P110④	With variable index	10	0,070

④ Potenziometro non fornito.

Operational characteristics

- Suitable for potentiometers with 6-6.3mm/0.24-0.25in diameter shaft
- Minimum 40mm/1.6in shaft length
- Ambient conditions:
 - Operating temperature: -25...+60°C
 - Storage temperature: -40...+70°C
- Any mounting position is allowed.
- Degree of protection: IP65 (warranted by potentiometers with a cylindrical shaft).

Materials

An aluminium and zinc alloy (zama) is used for the metal part whereas plastic parts are made of polyamide and polycarbonate.

Mechanical endurance

Mechanical life: 300,000 cycles.

Mounting adapter

Standard supply with actuator.
 Actuators latch onto the mounting adapter by simple rotation.
 The adapter is fixed to the mounting surface by means of incorporated screws (Tmax = 0.8Nm/0.59lbf).

Certifications and compliance

Certifications obtained: CCC and GOST.
 Compliant with standards: IEC/EN 60947-1, IEC/EN 60947-5-1.

Joysticks



8 LM2T J...
(without mechanical interlock)



8 LM2T J...
(with mechanical interlock)

Order code	Type of positions	N° contact elements	Qty per pkg	Wt
		NO	n°	[kg]

Without mechanical interlock. Label holder excluded.
Complete with auxiliary contacts.

8 LM2T J200		2	1	0.082
8 LM2T J201		2	1	0.082
8 LM2T J400		4	1	0.104
8 LM2T J401		4	1	0.104

With mechanical interlock in centre position.
Label holder excluded. Complete with auxiliary contacts.

8 LM2T J210		2	1	0.082
8 LM2T J211		2	1	0.082
8 LM2T J410		4	1	0.104
8 LM2T J411		4	1	0.104

Operational characteristics

- Ambient conditions:
 - Operating temperature: -25...+60°C
 - Storage temperature: -40...+70°C
- Any mounting position is allowed.
- Degree of protection:
 - IEC IP20 / UL type 1 for contact elements
- On front:
 - Per IEC/EN: IP65
 - Per UL: type 1, 2, 3R, 4, 4X, 12, 12K.

Materials

An aluminium and zinc alloy (zama) is used for the metal parts whereas plastic parts are made of polyamide and polycarbonate.
The sealing boot is made of NBR rubber.

Mechanical endurance

Mechanical life: 1,000,000 cycles.

General characteristics of contact elements

Self-cleaning with dual effect, scraping and oscillating
IEC rated insulation voltage: 690V
IEC rated thermal current Ith: 10A.
UL/CSA and IEC/EN 60947-5-1 designation: A300 Q300.
IEC operational power in AC15:

[V]	12	24	48	120	240
[A]	6	6	6	6	3

IEC operational power in DC13:

[V]	12	24	48	125	250
[A]	0.55	0.55	0.55	0.55	0.27

Short circuit protection fuse: max calibre 10A gG/SC

Contact resistance: ≤20mΩ

Terminals: Clamp screw with washer

Maximum tightening torque: 1Nm / 0.74lbf.

Mounting adapter and contact elements

The joystick is standard supplied with the mounting adapter and contact elements.

The joystick latches onto the mounting adapter by simple rotation.

The adapter is fixed to the mounting surface by means of incorporated screws (Tmax = 0.8Nm/0.59lbf).

Auxiliary contacts snap onto the mounting adapter.

Two LM2T CJ... contacts are mounted with the LM2T J2... types while four on the LM2T J4... versions.

Certifications and compliance

Certifications obtained: CCC, GOST, UL Listed, for USA and Canada (File E93601), as Auxiliary Devices.

Compliant with standards: IEC/EN 60947-1,

IEC/EN 60947-5-1, UL508, CSA C22.2 n° 14.

Accessories

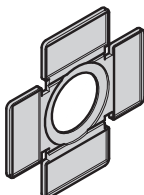

8 LM2T AU101

Order code	Description	Qty per pkg	Wt
		n°	[kg]
8 LM2T AU101	2-4 directional holder for adhesive legends	10	0.004

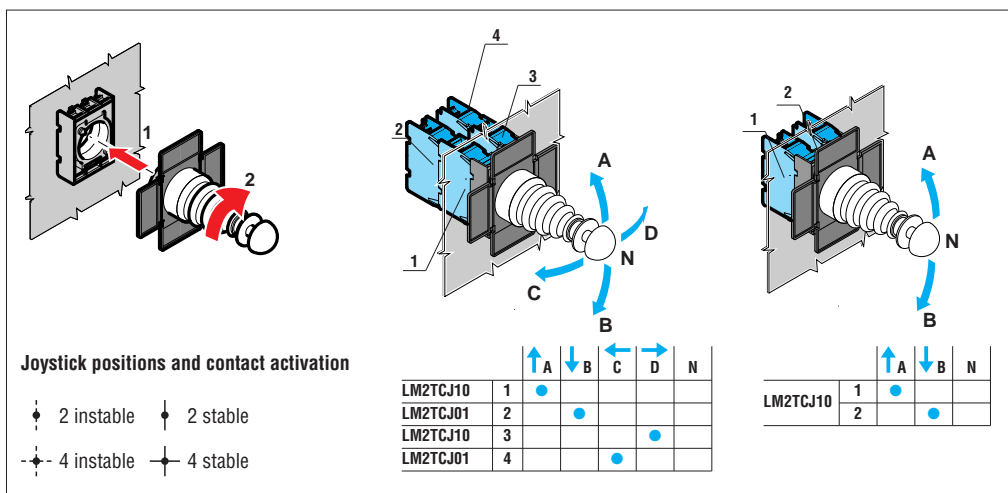

Mounting adapter



8 LM2T AU120

Order code	Description	Qty per pkg	Wt
		n°	[kg]
Only for metal series actuators.			
8 LM2T AU120	Mounting adapter	10	0.019

Contact elements



8 LM2T C...



8 LM2T E...



8 LM2T CF01



8 LM2T CF10

Order code	Function	Qty per pkg	Wt
	All SPST	n°	[kg]

Screw termination.
Without mounting adapter.

8 LM2T C10Ⓢ	NOⓈ	10	0.011
8 LM2T C10A	EMⓈ	10	0.011
8 LM2T C01⊖	NCⓈ	10	0.011
8 LM2T C01DⓈ	LBⓈⓈ	10	0.011

Screw termination.
With mounting adapter for actuators metal series LM2T... only.

8 LM2T E10Ⓢ	NOⓈ	10	0.029
8 LM2T E01⊖	NCⓈ	10	0.029

Faston termination
Without mounting adapter.

8 LM2T CF10Ⓢ	NOⓈ	10	0.012
8 LM2T CF01⊖	NCⓈ	10	0.012

- Ⓢ Not suitable for push-push actuators. Use LM2T C10A (EM) or LM2T C01 (NC) type only with push-push actuators.
- Ⓢ Normally open contact with early make operation.
- ⊖ Direct opening operation in accordance with IEC/EN 60947-5-1.
- Ⓢ Normally closed contact with late break operation.

Operational characteristics

- Ambient conditions:
 - Operating temperature: -25...+60°C
 - Storage temperature: -40...+70°C
- Any mounting position is allowed.
- Degree of protection per IEC/EN:
 - IP20 for contacts elements with screw termination
 - IP00 for contact elements with Faston termination
- Tightening torque: 1Nm/1.57lbf max (except Faston).

General characteristics of the contact elements

Self-cleaning with dual effect, scraping and oscillating
IEC rated insulation voltage: 690V
IEC rated thermal current Ith: 10A
Conductivity: 5V 10mA.

UL/CSA and IEC/EN 60947-5-1 designation: A600 Q600

IEC operational power in AC15:

[V]	12	24	48	120	240	400	480	500	600
[A]	6	6	6	6	3	1.9	1.5	1.4	1.2

IEC operational power in DC13:

[V]	12	24	48	125	250	440	500	600
[A]	3	3	1.5	0.55	0.27	0.15	0.13	0.1

Short-circuit protection fuse: max. calibre 10A gG/SC

Contact resistance: ≤20mΩ

Terminals: Clamp screw with washer

Faston 1-6.35mm/0.25in or 2-2.8mm/0.11in.

Stroke of contact elements

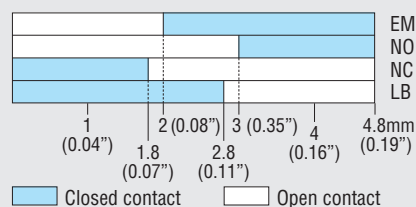

Maximum conductor cross section for screw terminals

1 o 2 2.5mm² or AWG12 cables.

Mechanical and electric endurance

Operating force: 0.5kg / 1.1lb (contact elements).

Electrical life:	LM2T C10	1,000,000 cycles
	LM2T CF10	1,000,000 cycles
	LM2T C01	1,000,000 cycles
	LM2T CF01	1,000,000 cycles
	LM2T C10A	600,000 cycles
	LM2T C01D	600,000 cycles.

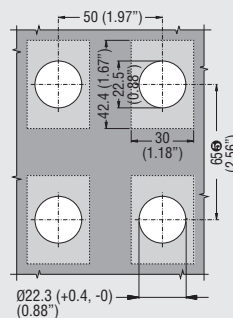

Ⓢ When using Faston, pitch is 90mm minimum.

Certifications and compliance

Certifications obtained: RINA, LROS, GOST, CCC, UL Listed, for USA and Canada (File E93601), as Auxiliary Devices.

Compliant with standards: IEC/EN 60947-1, IEC/EN 60947-5-1, UL508, CSA C22.2 n° 14.

Lamp-holders without mounting adapter



8 LM2T EL400
8 LM2T ZL230

8 LM2T YL...
8 LM2T GL...



8 LM2T T100

Order code	Rated auxiliary supply voltage	Type of bulb supplied	Qty per pkg	Wt
	[V] 50/60Hz		n°	[kg]
Direct supply.				
8 LM2T EL400	≤415VAC/DC	No	10	0.011
With resistor and diode.				
8 LM2T ZL230	230VAC	Yes 130V, 2W	10	0.015
With transformer.				
8 LM2T YL110	110-120VAC	Yes 24V, 1.2W	1	0.086
8 LM2T YL230	220-240VAC	Yes 24V, 1.2W	1	0.084
8 LM2T YL400	380-415VAC	Yes 24V, 1.2W	1	0.087
Flashing.				
8 LM2T GL048	24-48VAC	No	1	0.027
8 LM2T GL230	110-230VAC	No	1	0.027
Test element for lamp-holders.				
8 LM2T T100	Test element	⑥⑦	10	0.011

Lamp-holders with mounting adapter



8 LM2T DL400 - 8 LM2T VL230



8 LM2T XL... - 8 LM2T FL...

Order code	Rated auxiliary supply voltage	Type of bulb supplied	Qty per pkg	Wt
	[V] 50/60Hz		n°	[kg]
Direct supply.				
8 LM2T DL400	≤415VAC/DC	No	10	0.029
With resistor and diode.				
8 LM2T VL230	230VAC	Yes 130V, 2W	10	0.032
With transformer.				
8 LM2T XL110	110-120VAC	Yes 24V, 1.2W	1	0.105
8 LM2T XL230	220-240VAC	Yes 24V, 1.2W	1	0.103
8 LM2T XL400	380-415VAC	Yes 24V, 1.2W	1	0.106
Flashing.				
8 LM2T FL048	24-48VAC	No	1	0.046
8 LM2T FL230	110-230VAC	No	1	0.046

- ① Filament bulb, BA9s U_s≤130VAC/DC max 2.6W (not supplied); maximum dimensions 11x28 mm (0.4x1.1in). For higher voltages, use neon bulbs.
- ② Not suitable for 3-position selectors.
- ③ Filament bulb, BA9s (not supplied); maximum dimensions 11x28mm (0.4x1.1in). Suitable for AC duty only.
Use bulbs with rated voltage equal to that of the power supply.
E.g.: With LM2T FL230 use 110VAC bulbs if power supply is 110VAC and 230VAC bulbs if power supply 230VAC. 2.6W max bulb rating.
- ④ MultiLED bulbs must not be fitted.
- ⑤ In case of test circuits for lamp-holders having load in parallel, two LM2T T100 elements are required for each bulb.
Refer to the wiring diagram attached to the product or consult Customer Service; see contact details on inside front cover.
- ⑥ In case of neon bulbs, contact our consult Customer Service; see contact details on inside front cover.
- ⑦ Luminosity is reduced during testing of lamp-holder LM2T L... and LM2T M... types.

Operational characteristics

- Ambient conditions:
 - Operating temperature: -25...+60°C
 - Storage temperature: -40...+70°C
- Any mounting position is allowed.
- Degree of protection per IEC/EN: IP20
- Maximum tightening torque: 1Nm/1.57lbf.

Maximum conductor cross section

1 o 2 2.5mm² or AWG 12 cables.

Wiring diagrams

Direct supply

LM2T EL400

LM2T DL400



With resistor and diode

LM2T ZL230

LM2T VL230



With transformer

LM2T YL...

LM2T XL...



Flashing

LM2T GL...

LM2T FL...



Test element

LM2T T100



Certifications and compliance

Certifications obtained: RINA, LROS, GOST, CCC, UL Listed, for UA and Canada (File E93601), as Auxiliary Devices.

Compliant with standards: IEC/EN 60947-1, IEC/EN 60947-5-1, UL508, CSA C22.2 n° 14.

LED integrated lamp-holder steady or flashing light



8 LM2T LM3

7

Order code for steady light	Rated aux supply voltage ^①	LED colour	Qty per pkg	Wt
	[V]		n°	[kg]
Supplied without mounting adapter.				
8 LM2T LB3	18-30V AC/DC	Green	10	0.016
8 LM2T LB4		Red	10	0.016
8 LM2T LB5		Yellow	10	0.016
8 LM2T LB6		Blue	10	0.016
8 LM2T LB8		White	10	0.016
8 LM2T LE3	85-140V AC	Green	10	0.016
8 LM2T LE4		Red	10	0.016
8 LM2T LE5		Yellow	10	0.016
8 LM2T LE6		Blue	10	0.016
8 LM2T LE8		White	10	0.016
8 LM2T LM3	187-265V AC	Green	10	0.016
8 LM2T LM4		Red	10	0.016
8 LM2T LM5		Yellow	10	0.016
8 LM2T LM6		Blue	10	0.016
8 LM2T LM8		White	10	0.016

① Steady-light 9-15VAC/DC types are available on request; consult Customer Service; see contact details on inside front cover.

② Luminosity is reduced during test with test element LM2T T100.

Order code for flashing light	Rated aux supply voltage	LED colour	Qty per pkg	Wt
	[V]		n°	[kg]
Supplied without mounting adapter.				
8 LM2T MB3	18-30V AC/DC	Green	10	0.016
8 LM2T MB4		Red	10	0.016
8 LM2T MB5		Yellow	10	0.016
8 LM2T MB6		Blue	10	0.016
8 LM2T MB8		White	10	0.016
8 LM2T ME3	85-140V AC	Green	10	0.016
8 LM2T ME4		Red	10	0.016
8 LM2T ME5		Yellow	10	0.016
8 LM2T ME6		Blue	10	0.016
8 LM2T ME8		White	10	0.016
8 LM2T MM3	187-265V AC	Green	10	0.016
8 LM2T MM4		Red	10	0.016
8 LM2T MM5		Yellow	10	0.016
8 LM2T MM6		Blue	10	0.016
8 LM2T MM8		White	10	0.016

② Luminosity is reduced during test with test element LM2T T100.

Operational characteristics

- Rated auxiliary supply voltage: 18-30VAC/DC; 85-140VAC; 187-265VAC
- Maximum consumption: 33mA (18-30VAC/DC)
28mA (85-140VAC)
25mA (187-265VAC)
- Electrical life: 100,000 hours
- Ambient conditions:
 - Operating temperature: -25...+60°C
 - Storage temperature: -40...+70°C
- Any mounting position is allowed
- Degree of protection: IP20
- Maximum tightening torque: 1Nm.

Maximum conductor cross section

1 o 2 2.5mm² or AWG12 cables.

Wiring diagram

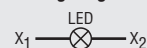

Certifications and compliance

Certifications obtained: GOST, CCC, UL Listed, for USA and Canada (File E93601), as Auxiliary Devices. Compliant with standards: IEC/EN 60947-1, IEC/EN 60947-5-1, UL508, CSA C22.2 n° 14-95.

Accessories and spare parts



8 LM2T AT...



8 LM2T AU100



8 LM2T AU105



8 LM2T AU108
8 LM2T AU106



8 LM2T AU170

Order code	Description	Qty per pkg n°	Wt [kg]
8 LM2T AT... ^①	Printed label to be inserted in pilot lights and push-buttons	50	0.001
8 LM2T AU100 ^②	Legend holder	50	0.001
8 LM2T AU105 ^②	Legend holder (for 8 LM2T AU106 paper or 8 LM2T AU108 plastic labels)	50	0.003
8 LM2T AU106	Blank paper label for writing (for LM2T AU105)	50	0.002
8 LM2T AU107	Transparent protection for LM2T AU106 label	50	0.001
8 LM2T AU108	Blank plastic label for engraving (for LM2T AU105)	50	0.002
8 LM2T AU13 ^③	IP66 boot for flush and illuminated push-buttons	10	0.006
8 LM2T AU14 ^③	IP66 boot for extended and illuminated push-buttons	10	0.009
8 LM2T AU157	IP66 boot for double and triple push buttons (transparent)	10	0.007
8 LM2T AU167	IP66 protective boot for mushroom head buttons LM2T B624... and LM2T B634... (transparent)	10	0.012
8 LM2T AU170	Actuator gasket	10	0.006

- ① Available only on specific request consult Customer Service; see contact details on inside front cover.
- ② To preserve actuators degree of protection (IEC IP65 / UL tupe 4X), place their gasket between legend holder and mounting surface.
- ③ For flush and extended push-buttons, complete the order code by adding the digit of the required colour:
2 (black); 3 (green); 4 (red); 5 (yellow); 6 (blue); 7 (transparent); 8 (white).
For illuminated push-buttons, add only digit 7 (transparent).

Labels with text for LM2T AU100 legend holder



8 LM2T AGB230

Ordering code	Text	Qty per pkg	Wt
		n°	[kg]
General use.			
8 LM2T AU206	Blank for writing	50	0.001
8 LM2T AU207	Sheet with 108 labels for laser printing ^①	1 ^②	0.005
8 LM2T AU208 ^③	Sheet with 108 laser-printed labels ^①	1 ^②	0.005
8 LM2T AGB216	CLOSE	50	0.001
8 LM2T AGB220	EMERGENCY	50	0.001
8 LM2T AGB231	FAST	50	0.001
8 LM2T AGB263	FAULT	50	0.001
8 LM2T AGB215	FORWARD	50	0.001
8 LM2T AGB228	LEFT	50	0.001
8 LM2T AGB218	LOWER	50	0.001
8 LM2T AGB221	OFF	50	0.001
8 LM2T AGB223	ON	50	0.001
8 LM2T AGB211	OPEN	50	0.001
8 LM2T AGB229	POWER ON	50	0.001
8 LM2T AGB227	RAISE	50	0.001
8 LM2T AGB226	RESET	50	0.001
8 LM2T AGB222	REVERSE	50	0.001
8 LM2T AGB217	RIGHT	50	0.001
8 LM2T AGB241	RUNNING	50	0.001
8 LM2T AGB224	SLOW	50	0.001
8 LM2T AGB225	START	50	0.001
8 LM2T AGB230	STOP	50	0.001
8 LM2T AGB214	STOP RESET	50	0.001
8 LM2T AGB240	THERMAL FAULT	50	0.001
8 LM2T AGB237	TRIP	50	0.001
For selector switches.			
8 LM2T AI233	AUTO-MAN	50	0.001
8 LM2T AI234	AUTO-O-MAN	50	0.001
8 LM2T AI241	MAN-AUTO	50	0.001
8 LM2T AI242	MAN-O-AUTO	50	0.001
8 LM2T AGB235	FWD-O-REV	50	0.001
8 LM2T AGB236	OFF-ON	50	0.001
8 LM2T AGB232	STOP-START	50	0.001
International labels for push-buttons.			
8 LM2T AU200	O	50	0.001
8 LM2T AU201	I	50	0.001
8 LM2T AU202	II	50	0.001
International labels for selector switches.			
8 LM2T AU203	O-I	50	0.001
8 LM2T AU204	I-II	50	0.001
8 LM2T AU205	I-O-II	50	0.001

- ① Recommended use with LM2T AU206 blank label.
- ② Sheet with 108 adhesive labels.
- ③ Complete code with label text required.

General characteristics

The labels have indelible scratch-proof black lettering on metalised grey polycarbonate background (adhesive).

Special versions

Labels in different languages are available. Consult Customer Service; see contact details on inside front cover.

Plastic disk for mushroom head pushbuttons

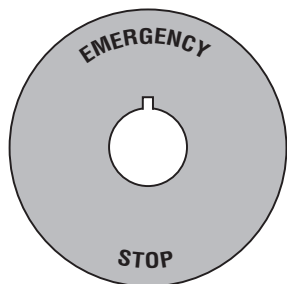

Ordering code	Text	Qty per pkg	Wt
		n°	[kg]
8 LM2T AU113	EMERGENCY STOP Ø90mm / 3.5in	10	0.005
8 LM2T AU115	EMERGENCY STOP Ø60mm / 2.4in	10	0.005
8 LM2T AU118	NOT AUS / ARRET D'URGENCE / PARO EMERGENCIA Ø60mm / 2.4in	10	0.005

General characteristics

The disks are made of non-adhesive plastic. There is a 2x2mm / 0.08x0.08in index.

Special versions

The disk text in different languages is available. Consult Customer Service; see contact details on inside front cover.

Accessories and spare parts

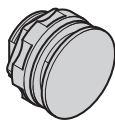

8 LM2T A130



8 LM2T A140

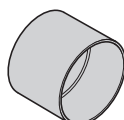

8 LM2T A185



8 LM2T AL...

- ❶ Complete the order code by adding the digit of the selected colour: 3 (green); 4 (red); 5 (yellow); 6 (blue); 7 (transparent); 8 (white).
- ❷ Versions with different key code. Complete with the numeric code of the key. The following versions are available: 501, 502, 503, 504, 505, 506, 507, 508, 509, 510.
Example of complete code: 8 LM2T A170G505. Coloured key versions are available on request; consult Customer Service; see contact details on inside front cover.
- ❸ Add the digit of the selected colour: 3 (green); 4 (red); 5 (yellow). Bulb size: 0.4x1.1in. It is advisable to use the same colour of bulb as of the actuator to obtain adequate light emission. Not suitable for resistor-diode lamp holders.
- ❹ Neon bulbs emit an amber light and may not be suitable for use with green or blue pilot lights and illuminated actuators. Bulb size: 0.4x1.1in.
- ❺ Glass with diffuser lens.
- ❻ Plastic neon bulb.

Order code	Description	Qty per pkg n°	Wt [kg]
8 LM2T A12❶	Coloured diffuser for double push-buttons	10	0.001
8 LM2T A130	Threaded plug for unused drilled holes	10	0.007
8 LM2T A140	Action plug for centre contact	50	0.001
8 LM2T A150	Rod for mechanical reset button (l=140mm/5.5in max)	10	0.006
8 LM2T A160	BA9s bulb extractor	10	0.004
8 LM2T A161	30mm/1.2in hole size adapter set for 22mm/0.87in (use 2 per hole)	10	0.002
8 LM2T A170	Spare key set for selector or mushroom head button	1	0.008
8 LM2T A170G❷	Spare key set for G series selector or mushroom-head button	1	0.008
8 LM2T A185	Selector protection shroud for knob types only	10	0.004
8 LM2T A190	Diffuser for pilot light	10	0.003
8 LM2T ALA024	Filament bulb BA9s 24VAC/DC 1.2W, size 10x28mm/0.4x1.1in	50	0.002
8 LM2T ALB024	Filament bulb BA9s 24VAC/DC 2W, size 10x28mm/0.4x1.1in	50	0.003
8 LM2T ALB048	Filament bulb BA9s 48VAC/DC 2W, size 10x28mm/0.4x1.1in	50	0.003
8 LM2T ALB130	Filament bulb BA9s 130VAC/DC 2W, size 10x28mm/0.4x1.1in	50	0.003
8 LM2T ALL006❸	MultiLED bulb BA9s 6VAC/DC 10x28mm	10	0.003
8 LM2T ALL024❸	MultiLED bulb BA9s 24VAC/DC 10x28mm	10	0.003
8 LM2T ALL048❸	MultiLED bulb BA9s 48VAC/DC 10x28mm	10	0.003
8 LM2T ALN130❹	Neon bulb ❹ BA9s 110/125VAC 10x28mm	50	0.003
8 LM2T ALN250❹	Neon bulb ❹ BA9s 220/250VAC 10x28mm	50	0.003
8 LM2T ALN400❹	Neon bulb ❹ BA9s 380/400VAC 10x28mm	50	0.003
8 LM2T ALP130❹	Neon bulb ❹ BA9s 110/125VAC 10x28mm	50	0.003
8 LM2T ALP250❹	Neon bulb ❹ BA9s 220/250VAC 10x28mm	50	0.003
8 LM2T ALP400❹	Neon bulb ❹ BA9s 380/400VAC 10x28mm	50	0.003

COMBINATIONS FOR METAL SERIES PUSH BUTTONS AND SELECTOR SWITCHES

SPRING-RETURN BUTTONS

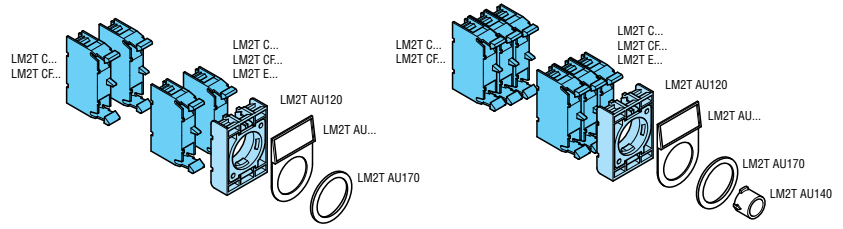

PUSH-PUSH BUTTONS

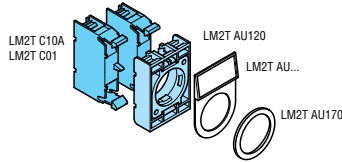
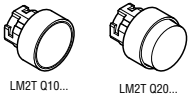

NORMAL STOPPING MUSHROOM-HEAD BUTTONS

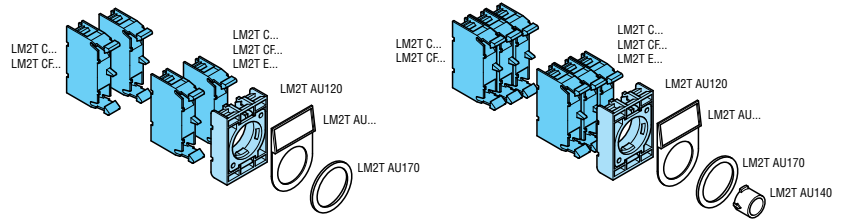
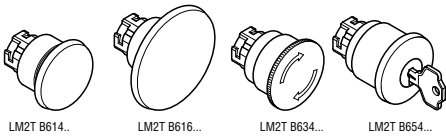

MUSHROOM-HEAD LATCH BUTTONS

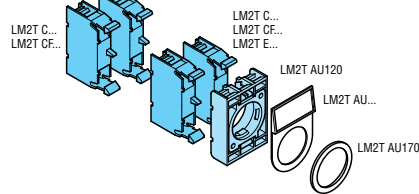
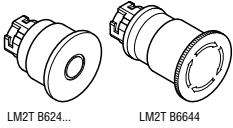

DOUBLE-TOUCH BUTTONS

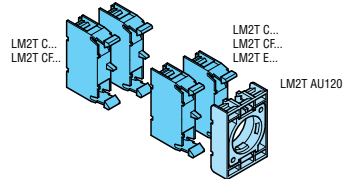
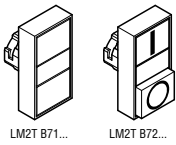

TRIPLE-TOUCH BUTTONS

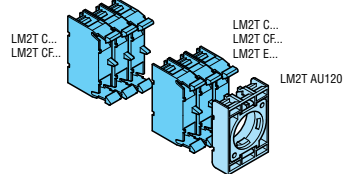
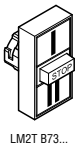

SELECTOR SWITCHES

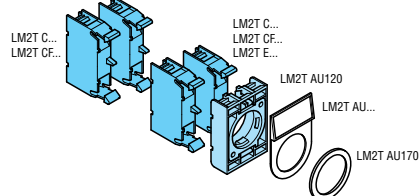
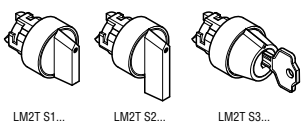

COMBINATION FOR METAL SERIES ILLUMINATED PUSHBUTTONS AND SELECTOR SWITCHES

SPRING-RETURN BUTTONS

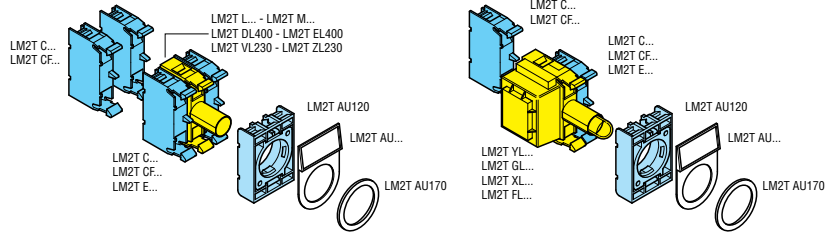
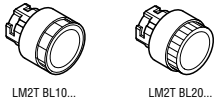

PUSH-PUSH BUTTONS

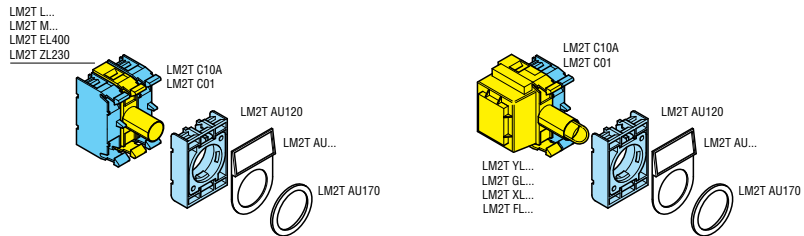

SPRING-RETURN MUSHROOM-HEAD BUTTON

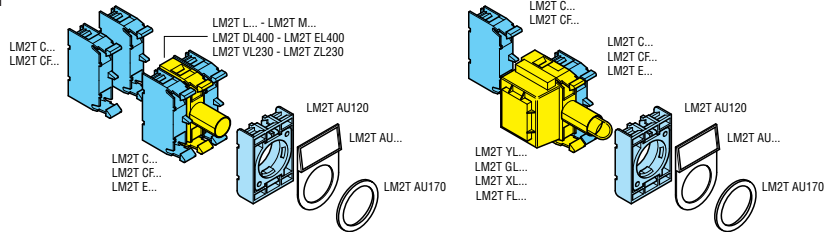
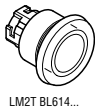

LATCH MUSHROOM-HEAD BUTTON

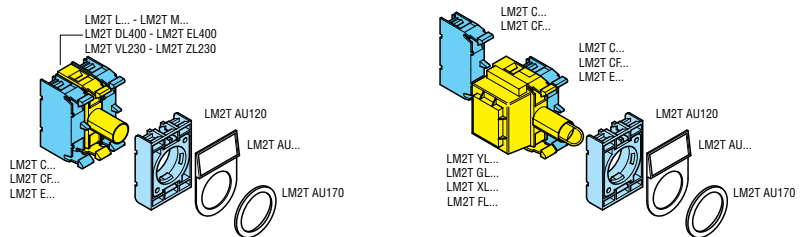
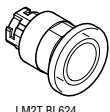

DOUBLE-TOUCH BUTTONS

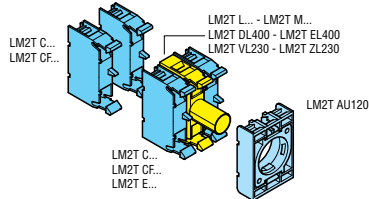
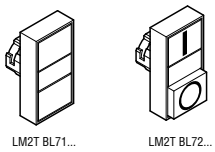

2-POSITION SELECTOR SWITCHES

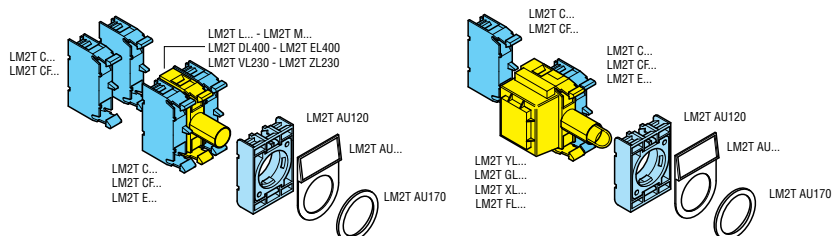

3-POSITION SELECTOR SWITCHES

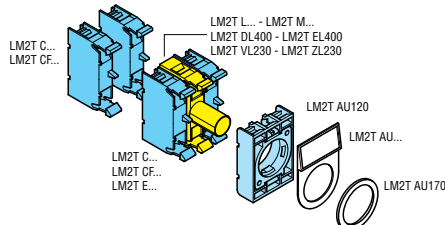
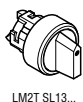

Empty with no actuators



8 L2PP 1A5



8 L2PP 2A8

Order code	Description	Cover colour	Qty per pkg	Wt
			n°	[kg]
8 L2PP 1A5	For 1 actuator	Yellow	1	0.138
8 L2PP 1A8	For 1 actuator	White	1	0.138
8 L2PP 2A8	For 2 actuators	White	1	0.198
8 L2PP 3A8	For 3 actuators	White	1	0.213
8 L2PP 4A8	For 4 actuators	White	1	0.253
8 L2PP 5A8	For 5 actuators	White	1	0.275

General characteristics

Control stations have cable entry through the top or the bottom and come fitted with a conduit (21.3mm (0.84in) entry diameter).

Operational characteristics

- Degree of protection: IP65 using adequate cable glands, not included in the supply. IP52 for L2PP 5A8 only.
- Tightening torque of cover fixing screws: 0.8Nm/0.57lbf.ft.
- Ambient conditions:
 - Operating temperature: -25...+60°C
 - Storage temperature: -40...+70°C.

Materials

Self-extinguishing ABS plastic.

Certifications and compliance

Certifications obtained: CCC, GOST, UL Listed, for USA and Canada (File E300050), as Industrial Control Panels. Compliant with standards: IEC/EN 60947-1, IEC/EN 60947-5-1, UL508A, CSA C22.2 n° 14.

Complete with one pushbutton



LPP 1B8 01



LPP 1B5 02



8 L2PP 160

new

Order code	Enclosure description	Pushbutton description	Qty	Wt
			per pkg	[kg]
LPP 1B8 01	White, 1 hole 8 L2PP 1A8	E-stop p/button LPC B6744	1	0.264
LPP 1B8 02	White, 1 hole 8 L2PP 1A8	E-stop p/button LPC B6344	1	0.213
LPP 1B5 02	Yellow, 1 hole 8 L2PP 1A5	E-stop p/button LPC B6344	1	0.213
LPP 1B5 03	Yellow, 1 hole 8 L2PP 1A5	E-stop p/button LPC B6644	1	0.244
8 L2PP 160	White, 1 hole 8 L2PP 1A8	E-stop p/button 8 LM2T B6344	1	0.240
8 L2PP 165	Yellow, 1 hole 8 L2PP 1A5	E-stop p/button 8 LM2T B6344	1	0.240
8 L2PP 180	Yellow, 1 hole 8 L2PP 1A5	E-stop p/button 8 LM2T B6644	1	0.271

① Red mushroom-head latch version, turn to release, yellow lid, per ISO 13850.

General characteristics

Control stations are duly fitted with pushbutton actuator, mounting adapter, label holder and "STOP" label (except for types with yellow lid) and one NC contact element. Control stations have cable entry through the top or the bottom and come fitted with a conduit (21.3mm/0.84in entry diameter).

Operational characteristics

- Degree of protection: IP65 using adequate cable glands, not included in the supply
- Tightening torque of cover fixing screws: 0.8Nm/0.54lbf
- Ambient conditions:
 - Operating temperature: -25...+60°C
 - Storage temperature: -40...+70°C.

Materials

Self-extinguishing ABS plastic.

Certifications

Certifications obtained: GOST, CCC (only for versions with LM2T... actuators).

PLATINUM SERIES PUSHBUTTONS AND SELECTOR SWITCHES

Flush pushbutton with contact elements or lamp-holder

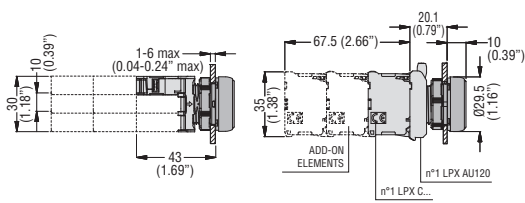

Flush pushbutton with Faston contact elements

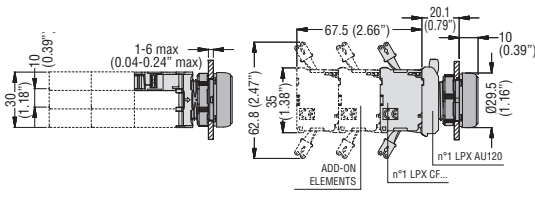

Drilling - Minimum recommended distances

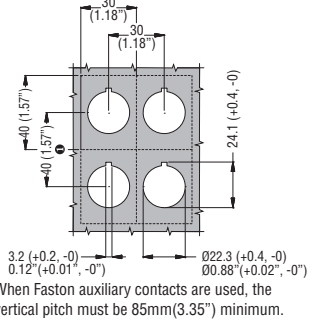

Pushbutton actuators

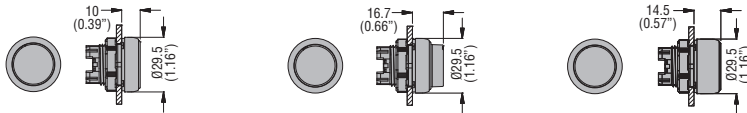

- Flush
LPC B1...
- Push-push
LPC Q1...
- Illuminated flush
LPC BL1...
- Illuminated push-push
LPC QL1...
- Extended
LPC B2...
- Push-push
LPC Q2...
- Illuminated extended
LPC BL2...
- Illuminated push-push
LPC QL2...
- Shrouded
LPC B30...

Mushroom-head button actuators

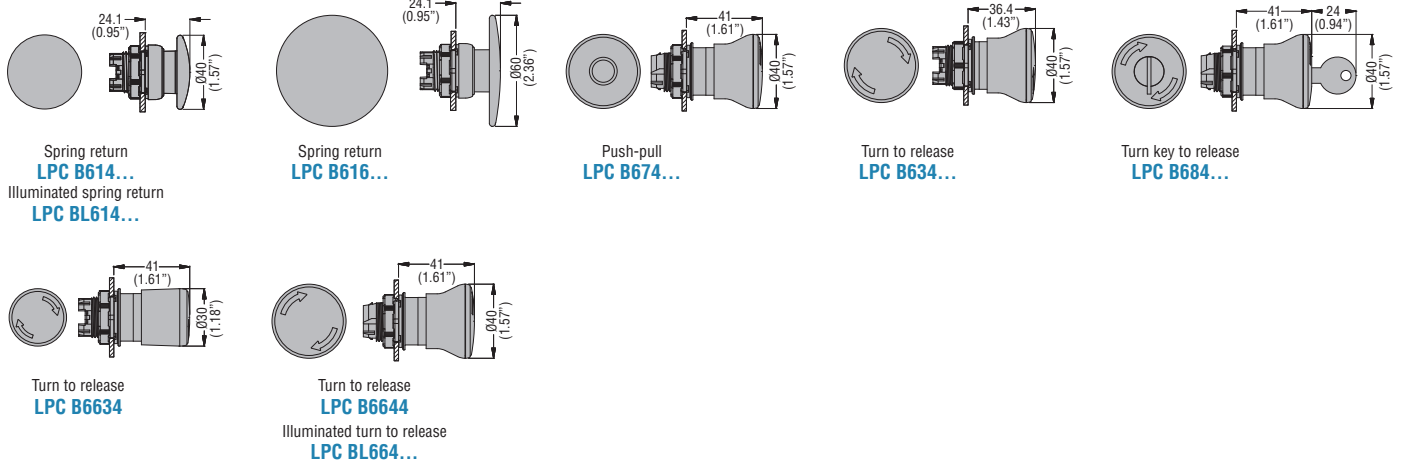

- Spring return
LPC B614...
- Illuminated spring return
LPC BL614...
- Spring return
LPC B616...
- Push-pull
LPC B674...
- Turn to release
LPC B634...
- Turn key to release
LPC B684...
- Turn to release
LPC B6634
- Turn to release
LPC B6644
- Illuminated turn to release
LPC BL664...

Reset button (complete unit)

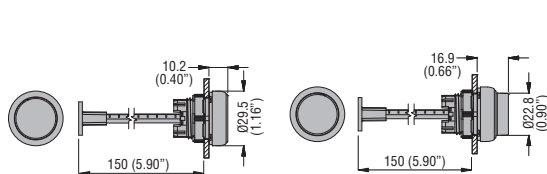

- Flush
LPC R1...
- Extended
LPC R2004

Double-touch actuators with or without indicator 2 flush buttons

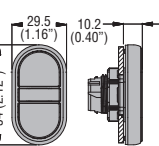

- LPC B71... - LPC BL71...**

Double-touch actuators with or without indicator 1 flush and 1 extended buttons

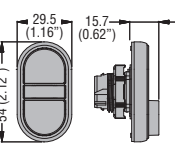

- LPC B72... - LPC BL72...**

Triple-touch actuators with middle extended button

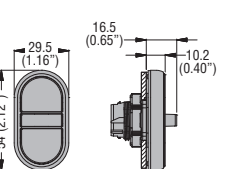

- LPC B73...**

Selector switch actuators



- Knob
LPC S1...
- Illuminated knob
LPC SL1...
- Key
LPC S3...

Pilot light head

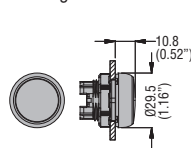

- LPL...**

LED-integrated monoblock pilot lights - steady light

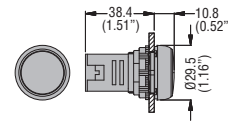

- 8 LP2T ILP...**

Monoblock buzzers

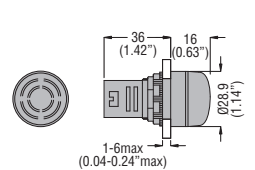

- LP2T ZG...**

Rubber boot for flush buttons

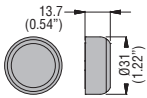

LPX AU13...

Rubber boot for extended buttons

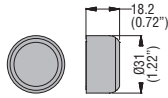

LPX AU14...

Rubber boot for mushroom-head buttons

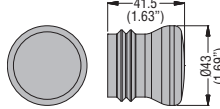

LPX AU167

Double/triple button boot

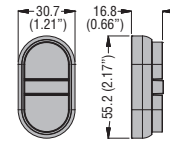

LPX AU157

Padlockable protection for mushroom-head latch buttons except LPC B634...

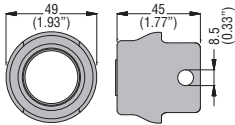

LPX AU158

Threaded plug for unused drilled holes

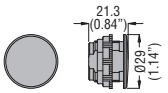

LM2T A130

Knob selector switch protection

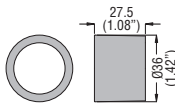

LM2T AU185

Label holder

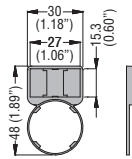

LPX AU105

Label

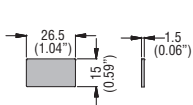

LPX AU108

Label holder

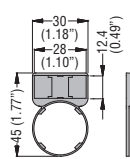

LPX AU100

Label

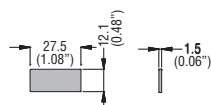

LPX AU109

Plastic disk for mushroom-head pushbuttons

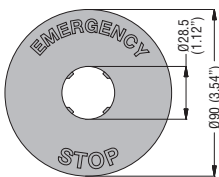

LPX AU113

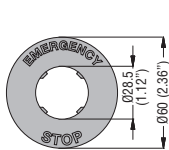

LPX AU115
LPX AU118

METAL PUSHBUTTONS AND SELECTOR SWITCHES

Flush pushbutton with contact elements or lamp-holder (direct or resistor-diode type)

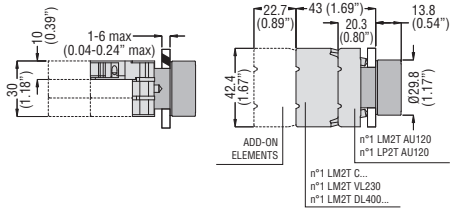

Flush pushbutton with Faston contact elements

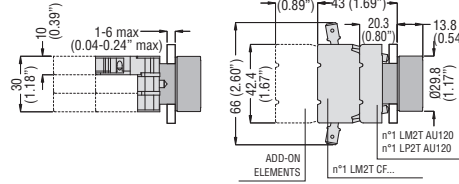

Drilling - Minimum recommended distances

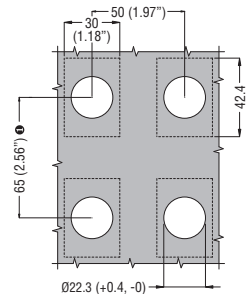

① When Faston auxiliary contacts are used, the vertical pitch must be 90mm(3.54") minimum.

Pushbutton actuators

7

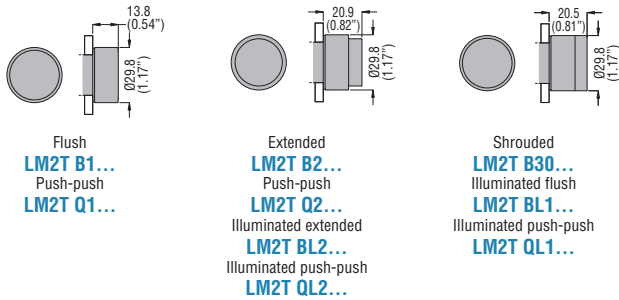

Mushroom-head button actuators

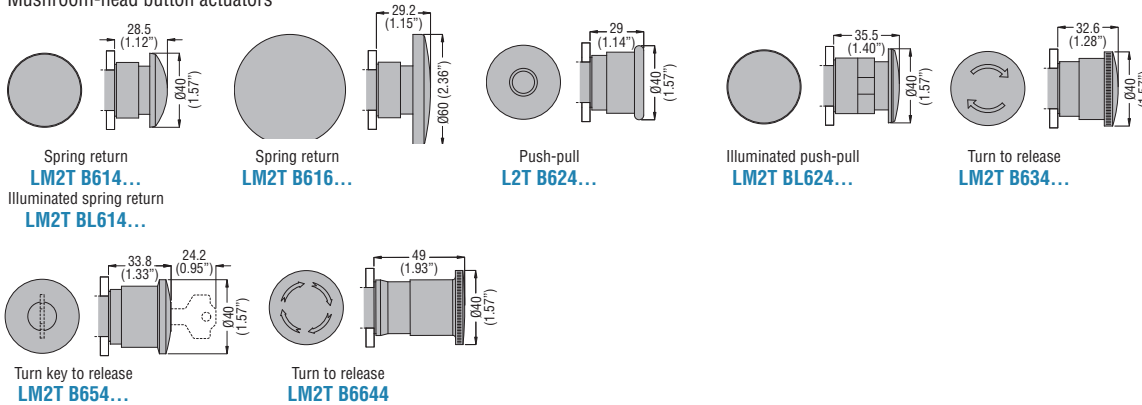

Double-touch actuators with or without indicator 2 flush buttons

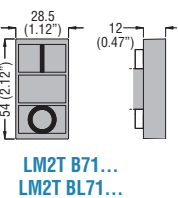

Double-touch actuators with or without indicator 1 flush and 1 extended buttons

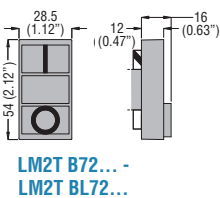

Triple-touch actuators with middle extended button

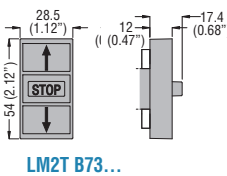

Selector switch actuators

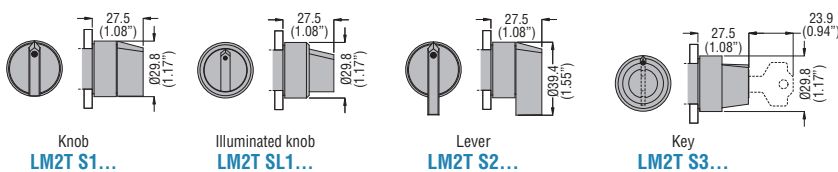

Reset button (complete unit)

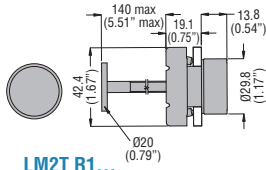

LM2T R1...

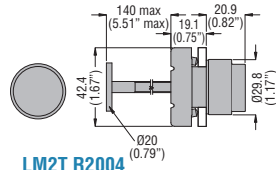

LM2T R2004

Potentiometer drive

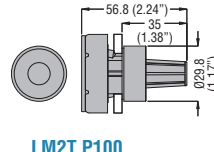

LM2T P100
LM2T P110

Pilot light head

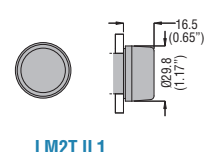

LM2T IL1...

LED integrated lamp-holder steady or flashing light

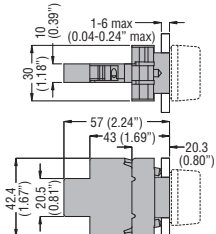

LM2T EL... - LM2T ZL...
LM2T DL... - LM2T VL...
LM2T L... - LM2T M...

Transformer or flashing lamp holder

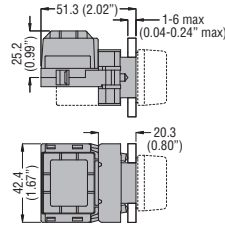

LM2T YL... - LM2T GL...
LM2T XL... - LM2T FL...

IP66 boot for flush and illuminated flush buttons

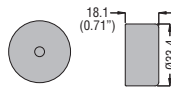

LM2T AU13...

IP66 boot for extended and illuminated extended buttons

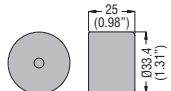

LM2T AU14...

IP66 boot for mushroom-head buttons

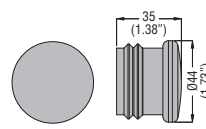

LM2T AU167

IP66 boot for double/triple touch buttons

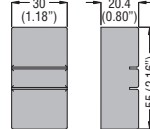

LM2T AU157

Threaded plug for unused drilled holes

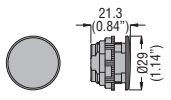

LM2T A130

Knob selector switch protection

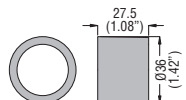

LM2T AU185

Label holder

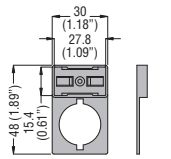

LM2T AU105

Label

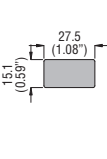

LM2T AU10...

Label holder

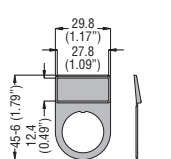

LM2T AU100

Label

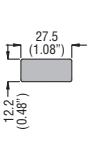

LM2T A...

Plastic disk for mushroom-head pushbuttons

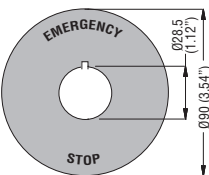

LM2T AU113

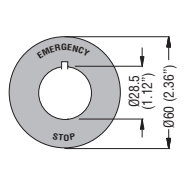

LM2T AU115
LM2T AU118

Joystick with free actuation lever

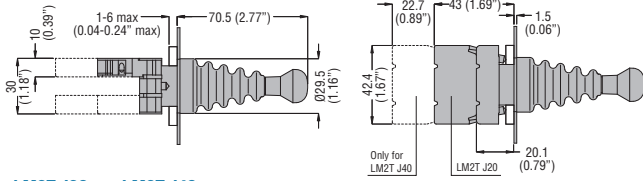

LM2T J20... - LM2T J40...

Joystick with mechanical latch lever

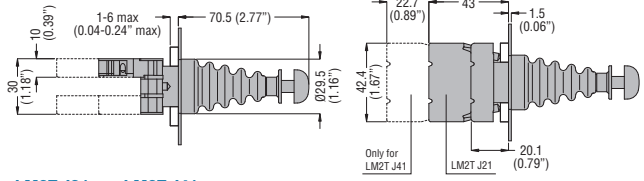

LM2T J21... - LM2T J41...

Control station for one actuator

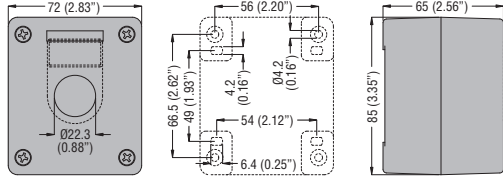

L2PP 1A5 - L2PP 1A8

Control station for two actuators

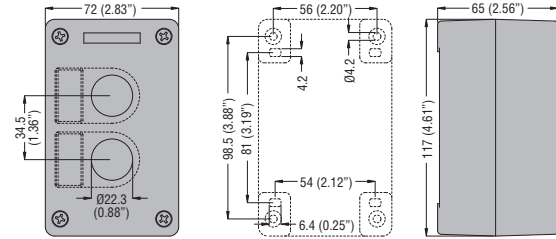

L2PP 2A8 (2x2mm (0.08x0.08") index)

For 3, 4 or 5 actuator versions, increase the total length by the pitch between the drillings, 35mm (1.38") for each extra actuator.

Complete pushbutton station with one actuator

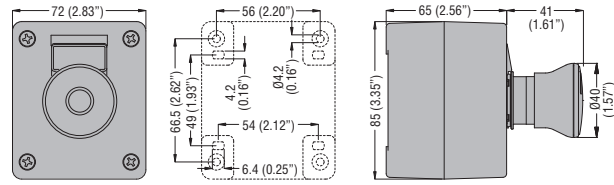

LPP 1B5 03
LPP 1B8 01

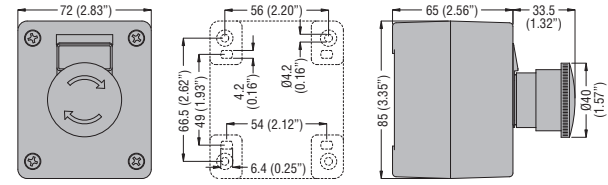

L2PP 160 - L2PP 165

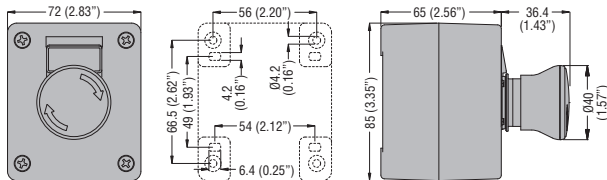

LPP 1B5 02
LPP 1B8 02

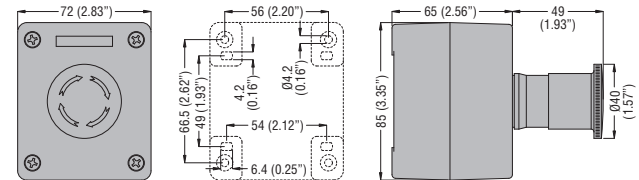

L2PP 180

FOR PUSHBUTTONS AND SELECTOR SWITCHES

LPX C10
LM2T C10



LPX C10A
LM2T C10A



LPX C01
LM2T C01



LPX C01D
LM2T C01D



LM2T EL400
LM2T DL400



LM2T ZL230
LM2T VL230

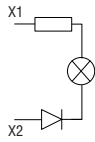

LM2T YL...
LM2T XL...

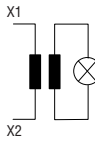

LM2T GL...
LM2T FL...

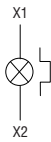

LM2T T100

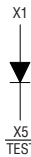

LPX L...
LM2T L...
LM2T M...



BUZZERS Ø 22mm
L...T ZG...

