

# 正面

尺寸: 420x285mm

四折页(105x142.5mm)

材质: 书写纸100g, 单面印刷

备注: 图中 - - - 虚线为

折叠线不需要印刷

生产大货时, 必须参照  
右边示意图折叠好!!!

折叠示意图:

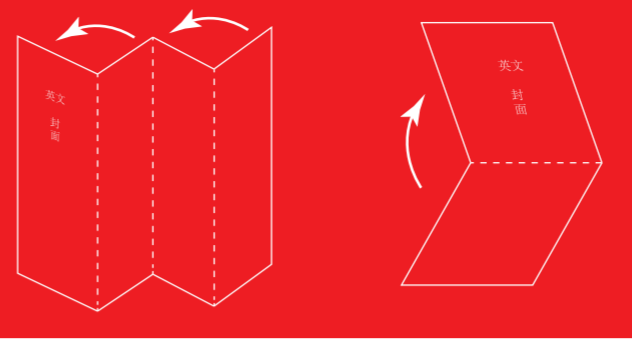

## PORTABLE POWER SUPPLY Universal Instruction manual

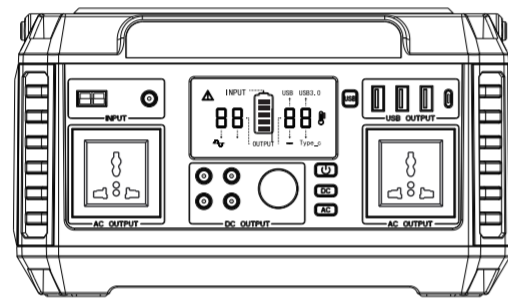

**ATTENTION:** This product user manual is universal for portable solar generator AC output range between 230V/50Hz. Actual product specification, actual AC outlets will be different according to different countries, areas or customers. Please refer to the actual product before you use the product.

### ABOUT THE UNIT

Thank you very much for applying our multi-function portable solar generator. In case of power failure or you need to charge on a travel, you can temporarily charge your electrical or digital products with this unit. This unit has been built in high quality lithium battery, supports for USB, DC and AC output. Before using this unit, please read the user manual carefully and properly keep for reference.

### ATTENTION!

This manual is to help you use the product correctly; it does not represent any description on the hardware and software configuration of the product. About the product configuration, please refer to the contract related to this product (if there is), or consult to the seller that sells the product. Pictures in this manual is for reference only, if there are individual pictures do not match the actual, please prevail in actual products.

### The unit provides Sine Wave output

The unit is built-in inverter, AC output waveform of "Wave". It is a waveform that has characteristics same to the sine wave shape of utility power. It can provide the cleanest, most stable AC voltage to your AC electric appliance. While traditional inverter output Modified Sine Wave output, which can cause unstabilities to electrical devices, such as an electrical fan, it will even make the electric appliance arouse some noise. Appliances like refrigerators, microwaves, and compressors that use AC motors and some delicate medical equipment will be better off with a pure sine wave inverter. **This product is only used for emergency, it cannot replace the normal alternating current, for long-term use.**

### 【 I 】 PRODUCT PARAMETERS

Capacity	520Wh (equivalent 140400mAh, 3.7V)
Dimensions(LWH)	288.8x189x166.4mm
Weight	about 5.6kg
Built-in Battery	High Quality Lithium ion Batteries
Input Recharging	Adapter: DC15V/6A Solar Panel Charging: DC18V~22V/6A Max
Fully Charged Time	DC15V/6A: 8~10 hours
USB Output	1 X USB 5V~9V/2A QC3.0 1 X Typ-c 5V~9V/2A QC3.0 2 X USB 5V/3.1A

DC Output	1x Cigarette Lighter Adapter 4x 5521 DC Output: 9~12.6V/10A(12A Max total)
AC Power	AC Continuous Output: 230V 50Hz, 560W, 1100W(Max)
Power Indicator	LED Display
Operation temperature	-10°C~40°C
Lifecycle	>800 times
Package include	1x Portable Power Supply 1x Power Adapter 1x Car Charger 1x user manual

※ There may be some differences on different spare parts. Please adhere to the actual product instead.

### 【 II 】 PRODUCT DESCRIPTION

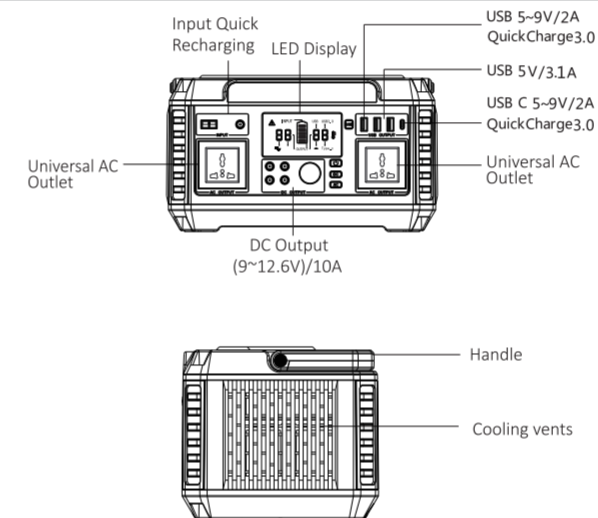

AC Outlet, AC output voltage and frequency will be different according to different countrise or areas, Please refer to the actual product before using.

### 【 LED Display 】

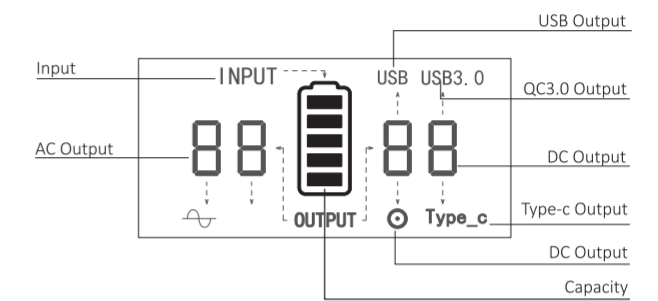

### 【 III 】 PRODUCT INSTRUCTION

1) How to provide power for DC12V appliances (such as head lamp, fan) with this product? The 5.5mm 12V DC output is plug and play. Plug your appliances to the DC output port to gain power. DC output rated power < 120W, Max output < 145W. Notices: Please confirm whether your DC 12V appliance support charging with 5.5mm DC header interface (the diameter of the DC Port of the Product is: 5.5mm), otherwise it unable to connect with the DC Output, you can consult the electrical manufacturer, buy the corresponding adapter and connect with it.

#### 【 Front 】

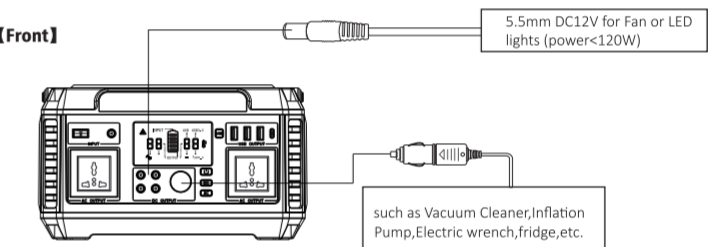

※ **Note:** The 12V DC output voltage is range between 9V~12.6V, maximum output current is 12A. DC output voltage drops while battery capacity drops due to chemical characteristics of the battery. If your appliance is not built-in input voltage stabilizing function, it may shutdown when input voltage is too low, please unplug your device from the unit in time. And please charge the unit in time.

### Protection Mode:

short-circuit/Overpower Protection: If the DC output is short-circuited or overpowered (Load power > 120W), the unit will shutdown to protect itself. Please press the DC switch again to resume use.

### 2) How to provide power for AC appliances with this product?

Connect the power cable plug of the electrical appliance to the AC outlet of the product, switch on the POWER-AC button and the unit will start providing power to your appliances. **WARNING!** The AC outlets, AC voltage and frequency are different according to different countrise; Please carefully check whether the product specifications are consistent with the appliance specifications before use, otherwise it can lead to dangerous situations.

#### 【 Left 】

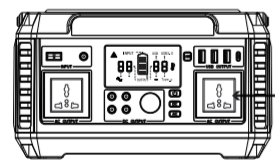

Limited Appliance Wattage < 560W. Lamp, Electric Fan, TV, etc. AC will shutdown when it's short circuited or power overloaded. Remove the device and the unit will recover from short-circuit or overpower protection in a few seconds. Re-press the AC output button to switch on ac output again

**Warning:** The plug standard and voltage differ according to countries. please make sure the socket standard matches your appliance before using, in case of any dangerous situations.

※ Please turn off the AC switch in time to save energy if you don't need AC output function

### Protection Mode

**Short circuit, over load protection:** For AC output Short circuit or over load (more than 560W) situation, the AC output function will be stopped, please remove the load and press the AC button for reactivation

※ Some electrical appliances, such as refrigerators, ice machines, laser printers, etc., there will be a peak power during start or working, which lasts very short time, but up to 1100W or above. The situation may activate the over load protection. Please remove the appliance, and press the AC button for reactivation.

### 3) How to use the power pack to supply the USB digital devices?

Connect the digital device to the USB interface of the power pack, press "USB" button, then it works.

※ **Note:** For some smart devices, such as the Bluetooth headset, LED lights, the charge current is very low, below 150mA, which is too low to be detected by the power pack, these smart devices can not get power from the power pack.

**Fast Charge 3.0 Technology:** The power pack supports Fast Charge 3.0 output technology and 5V-9V/2A max output, can be used for smart phones and pads which adopts QC3.0 technology. For exact charging voltage and current if these devices, please contact the manufacturer for more details.

#### 【 Front 】

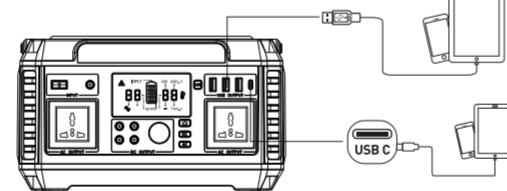

※ **Note:** When the product is in overloaded or short-circuit protection, please remove the load and USB auto activation

### 5) How to charge the unit?

#### a. Charge through AC Wall Charger

Using the included AC Wall Charger, plug the unit into any wall outlet to charge the unit. You will know the unit is charging when the blue LED battery indicators are blinking. The unit is fully charged when all battery indicators stop blinking and remain solid. After the unit is fully charged, please remove the AC wall charger in time.

#### 【 Right 】

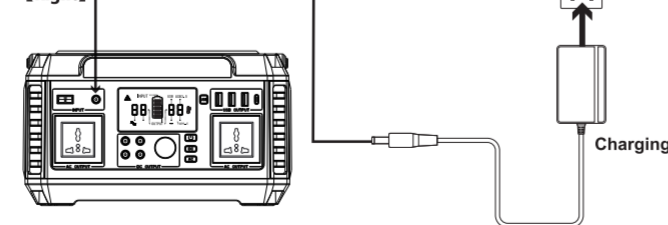

#### b. Charge from Solar panel

1. Place your solar panel where it will get as much direct sunlight as possible.  
2. Plug the output of the solar panel into the input of the unit to start charging. You will know the unit is charging when the blue LED Battery Indicator lights up and blinks. The unit is fully charged when all battery indicators stop blinking and remain solid.

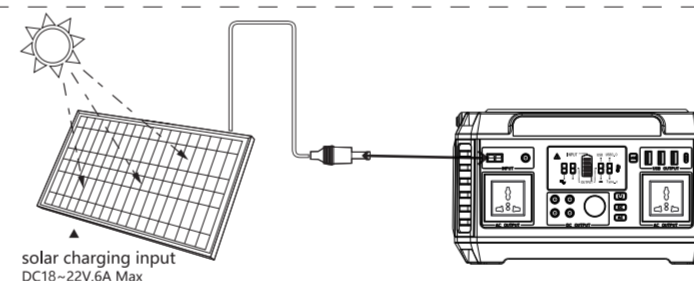

#### c. Charge from your car with a 12V cigarette lighter.

Using the included car charger, plug the unit into a 12V cigarette lighter (car port) of your car. You will know the unit is charging when the blue LED Battery Indicator lights up and blinks. The unit is fully charged when all battery indicators stop blinking and remain solid.

**Attention: To avoid car battery power loss. Charging this unit through your car cigarette lighter is only available when your car engine is started.**

### 【 IV 】 SECURITY AND MAINTENANCE

- Do not short-circuit the unit. To avoid short-circuiting, keep the unit away from all metal objects (e.g. coins, hair-pins, keys, etc.).
- Do not heat the unit, or dispose of it in fire, water or other liquids. Keep away from high temperatures. Do not expose the unit to direct sunlight.
- Keep away from high humidity, dusty places.
- Do not disassemble or reassemble this unit.
- Do not drop, place heavy objects on, or allow strong impact to this unit.
- This appliance is not intended for use by persons (including children) with reduced physical, sensory or mental capabilities, or lack of experience and knowledge, unless they have been given supervision or instruction concerning use of the appliance by a person responsible for their safety.
- Children should be supervised to ensure that they do not play with the appliance.
- The unit may become hot when charging. This is normal. Use caution when handling.
- Do not charge the unit over the required time.
- Disconnect the unit when fully charged.
- Use the unit properly to avoid electronic shock.
- Please deal with scrap products in accordance with the regulations, do not treat the built-in battery as a household garbage, so as not to cause the explosion and pollution.
- The product is only used for emergency situations, it cannot replace the standard DC or AC power of household appliances or digital products.

### 【 V 】 PRODUCT APPLICATION SKILLS

- This product is built in high quality original lithium ion battery, it has no memory effect but high-capacity, and it is durable. However, we still recommend you to apply in the range of 10°C ~ 40°C, so as to obtain the optimal charging capacity.
- When charging, in order to avoid interference, please stay away from TV, radio and other equipment.
- If the device has not been used for a long time, please disconnect the cable and store.
- Some portable devices may need to be set in charge mode to charge, see the corresponding equipment use manual for more information.
- In order to extend the life of product (lithium battery), it is best to charge within 3 months, and charge at least once within 6 months.

### Cold Weather Usage

Cold temperatures (below freezing) can affect the unit's battery capacity due to chemical characteristics of the battery. If you'll be living off-grid in sub-zero conditions, we recommend you keep your unit in an insulated cooler, and connected to a power source (solar panels). The natural heat generated by the unit contained in an insulated cooler will keep battery capacity at its highest.

### Recycle

Always return your used electronic products, batteries, and packaging materials to dedicated collection points. This way you help prevent uncontrolled waste disposal and promote the recycling of materials.

### Battery information

Your device has an internal, non-removable, rechargeable battery. Do not attempt to remove the battery, as you may damage the device. The battery can be charged and discharged over 800 times, but it will eventually wear out.



Email: info@flashfishtech.com

For more technical support, after-sales please feel free to contact us  
Flashfish Team:  
Website: www.flashfishtech.com (more contact info could be found on our website)