

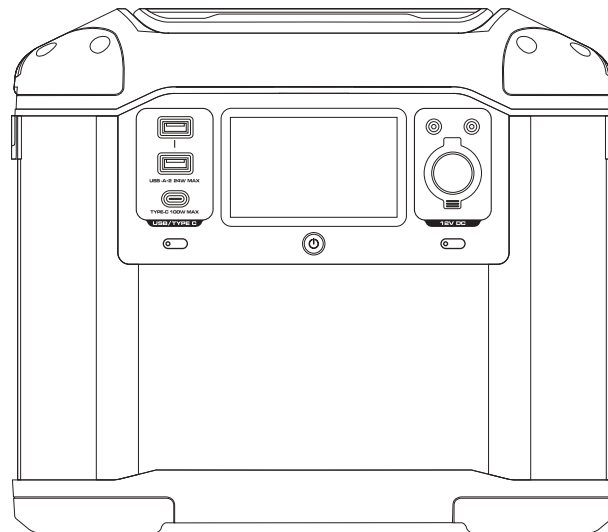

P15 | 1500W/280000mAh
POWER STATION

USER GUIDE



WARNING

- 1, Please keep dry and stay away from the fire.
- 2, Don't disassemble, stab or impact the product strongly.
- 3, Please recycle and dispose the product accord to the local laws and regulations.

IMPORTANT SAFETY INSTRUCTIONS

Attention-When using this product, basic precautions should always be followed, including the following:

01. Please read the instruction manual carefully before using the product.
02. To reduce the risk of injury, close supervision is required when using the product near children.
03. Don't put your fingers, palms or any part of your body into the product.
04. The use of unrecommended accessory products may lead to fire, electric shock or personal injury.
05. Don't use the damaged or modified battery packs and device.
06. Don't use damaged wires, plugs or output wires used by the product.
07. When the product needs maintenance or repair, do not disassemble the power supply. Please submit the mobile power supply to a qualified service provider, improper disassembly method may cause fire or electric shock risk.
08. To reduce the risk of electric shock when the product fails, remove the portable power supply from the socket before performing any directed repair operation.
09. Charge the internal battery in a well-ventilated place. Do not obstruct air circulation.
10. Under extreme conditions, liquid may be ejected from the battery. Avoid contact with batteries and liquids. In case of accidental contact, rinse with water. Seek medical help if fluid comes into contact with your eyes.
11. Don't expose the product to fire or overheating.
12. Repair by qualified maintenance personnel only.
13. The US and Japan only support 100-120V AC (50/60Hz) charging. Do not exceed the specified current and voltage. Otherwise, the company will not assume the responsibility of providing free maintenance services.

PLEASE KEEP SAFETY INSTRUCTION PROPERLY.

P15 GUIDELINES FOR USE, MAINTENANCE AND SAFETY.

First of all, congratulations on having the best portable power station in the world. This brief manual will help you. Please take moment to read it and follow the instructions to use the portable power station. Can you fully understand how to use a portable power station with just one reading.

If you are not used to reading the instruction manual, at least note the following: To turn on the P15 portable station or off, you need to long press the power button (6) to enable the AC output power jack, you will need to hold down the AC ON / OFF (14) with the P15 portable power station on. This was intentionally designed to save the battery power so that the P15 portable power station could be saved for an emergency.

Functions of P15 portable power station: to understand P15, please follow this manual to understand each port, buttons, display screen of P15. Technical parameters: to understand what technical specifications P15 has as an advanced portable power station.

How to Charge the P15 portable power stations: Charge the P15 portable power stations via AC cables or solar panels (if applicable)

Frequently asked questions: answers to important questions such as how to maintain P15 portable power stations and how to store and safely use P15 portable power stations.

Package list: A list of items that you will get after purchasing the P15 portable power station. If you find us with missing items on the list, please contact us at: into@flashfishstech.com

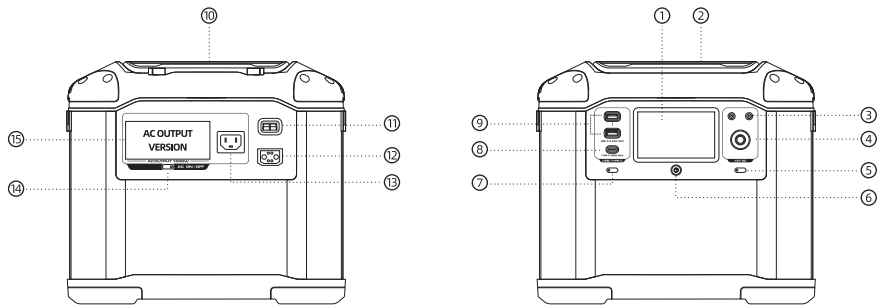

1. LCD display

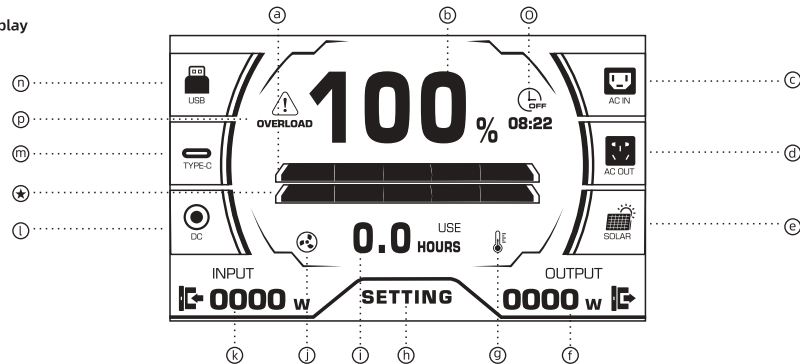

- a. **Power column display**-Display the current remaining power with energy bars. Each grid is 20% power. The energy bar shows red when the charge is below 20%. When the battery runs out, the red bar flashes. When this happens, please charge the P15 mobile power station in time.
- b. **Power digital percentage display**-shows the percentage remaining.
- c. **AC charging indicator**-The AC IN indicator icon lights on when AC charging the host. The input power starts to increase. The remaining use time becomes a charging time, the USE becomes a charging icon, and the energy bars are all displayed in blue.
- d. **AC output indicator**-AC OUT indicator icon on when the plug plugs into the AC socket. The OUT PUT output power shows the current power output level (reference f. Current output).
- e. **Solar Charging Instructions**-When charging the SOLAR icon appears when using solar panels. The input power starts to increase, and the remaining service time becomes the charging time (refer to C. Charging indication)
- f. **Current Output**-Displays the current power output level of the P15 portable power station in watt (W). When the multiple ports work simultaneously, the current total output power is displayed.
- g. **High temperature indicator**-Remind of abnormal P15 portable power station temperature when the thermometer red icon is lit. All input and output functions will stop running and the fan will start. The P15 portable power station will automatically resume operation after the cell or associated port cool down.
- h. **Settings**-Home settings SETING lights into the Settings page. You can function and personalize the P15 portable power stations (see SETTING features and personalization).
- i. **Remaining discharge/charge time**-Determine the remaining charge / discharge time based on the current power consumption situation of the P15 portable power station. When charging the P15 portable power station, the USE indicates an automatic switch to the charging icon ⚡.
- j. **Fan Indicator**-P15 Fan speed of a portable power station is positively correlated with the load used and ambient temperature by the user, and the higher the load or ambient temperature, the faster the fan speed.
- k. **Current Input**-Display the current power input level of the P15 mobile power supply in watt (W).
- l. **DC output**-The DC icon is lit up when using a DC (5521) port device.
- m. **Fast Charge Type-C port**-Use Type-c to charge devices, including the Macbook Pro. Choose an Android phone and any other device that is charged through the Type-c port. When the Type-c port is in use, the Type-c output indicates that the icon appears automatically.
- n. **USB port**-Charge a variety of devices such as iPhone, tablet, GoPro, speakers or all other device charged through the USB port. When the USB port is in use, the USB output indicates that the icon appears automatically.
- o. **Power pack power display**- When the P15 portable power station is combined with the matching power pack, the second power bar is lit up. It means that the battery pack is connected, and the battery capacity is doubled. (Note: When the P15 portable power station adopts the supporting power pack combination, the input charging gives priority to the party with less power first. When the two power is the same, the input charging will be charged at the same time.

- 0. Timed shutdown**-When the setting menu selects the timing shutdown function, the home screen timing shutdown icon appears, and the countdown shows the shutdown time (note: when the P15 portable power station charges itself, the function can not be started).
- p. Overload protection**-When the load power is greater than the rated power of the P15 host, the output is automatically turned off and the OVER LOAD is lit up to protect the appliance life and host safety. Please use electrical appliances not exceeding the rated power, and manually turn on the AC output switch when using them again.
- 2.Storage warehouse**-P15 portable power station upper practical storage warehouse design, can store relevant accessories and sundries, etc., simple and convenient storage!
- 3. DC output**-2 DC 5521 DC output interfaces, which can connect to the DC 5521 specification connection equipment for power supplytable power stationupper practical storage warehouse design, can store relevant accessories and sundries, etc., simple and convenient storage!
- 4. Car charging output port**-1 car charging output interface, supporting the maximum of 10A current output. It can be used for general vehicle appliances, but also to charge the 12V lead-acid battery of a car (it must be operated under the guidance of professionals).able power station upper practical stor-age warehouse design, can store relevant accessories and sundries, etc., simple and convenient storage.
- 5. DC Output Zone Switch**-Press DC ON / OFF to turn on or off the DC power of the P15 portable power station and turn the key indicator light on or off. This button controls the two DC 5521 interfaces and one charging interface of the portable power station. To save the power and protect the health of the battery, power off without DC output.
- 6. Main power key and direction selection**-tap the switch inward to open the portable power station. When the portable power station is on, the power indicator is on and the display is on; select a different menu by pushing up and down (see SETTING function and personalization). To save the power level and protect the health of the battery, please press the power key inward to turn off the power station.
- 7. USB Output Zone Switch**- Press USB / Type c Zone ON / OFF to turn on / off the DC power of the portable power station, with the key indicator light on or off. The USB or Type c port starts or stops the output work.
- 8. Type-C Output Port**- 1 maximum 100w att power Type-C port, if your device does not support fast charging, the device will charge at normal speed.
- 9. USB-A Output Port**- There are 2 USB-A ports, each with a maximum output power of 24 watts.
- 10. Auxiliary Lighting** -LED auxiliary lights are built in the storage warehouse top cover, tap the inner cover ON / OFF switch to turn the LED auxiliary lightson or off. Storage compartment cover with damping positioning enables a 120-degree on and off angle to adjust the LED auxiliary lamp illumination angle as required.
- 11. Solar charging input port**-supports up to 2*160 watt solar panels in series, with no limit on the parallel number, but the device itself will limit up to 300watt input.
- 12. Power pack expansion port**-can connect to the P15 portable power station matching power pack, to achieve the capacity doubling to bring morelasting battery life.
- 13. E-Speed charging input port**-Access to common AC cable (effective current 15A) and the other end to AC AC power supply (municipal input). in the US or Japan Only support 100V AC-120V AC (50 / 60Hz) / Intemational Edition 220V AC-240V AC (50 / 60Hz) charging. The E-Speed system of the portable powerstation has a fast charging function, which can charge up to 80% in an hour. The E-Speed feature also supports entry-level UPS(For specific functions, please refer to the introduction of EPS functions.)
- 14. AC Output Switch**-Tap the AC Output Zone Switch Area ON / OFF to turn on or off the AC power of the portable power station, with the key indicator on or off. The AC output port starts or stops the output work.
- 15. 3 AC Output (100-120V Region) / 2 AC Output (200-240V Region)** -Supply equipment at 110V (100-120V Region) / 220V (1500w, note equipment power and voltage before connecting to more equipment. Excessive power may cause your equipment to fail to function properly or damage it.

FUNCTIONALITY AND PERSONALIZATION SETTING

The portable power station setting button is designed with a five-way button. You can press inside to enter the Settings menu, and dial the up and down or left and right directions according to the specific menu options.

- 01. Language Settings**-portable power station is built-in Chinese, English, Japanese languages, you can choose the corresponding language version according to the user needs.
- 02. Frequency**-China and some European countries are rated at 50Hz and Japan and some of America at 60Hz. Please choose the correct frequency region of use. Wrong frequency selection may cause damage to the product, and the company will not take responsibility for providing free repair services.
- 03. UI setting**-P15 portable power station built-in technology simple style theme, users can choose the corresponding UI theme according to their preferences.
- 04. Screen brightness**-portable power station screen supports 11-level brightness adjustment, add and reduce the brightness case through the left and right butt-ons, complete the downward selection of "return" and return to the setting page.
- 05. Charging Speed**-Fast charging and slow charging options. (The portable power station supports the E-Speed fast charging mode, which can charge up to 80% in one hour. To extend your battery life, we recommend that you deeply discharge at least once every 3 months and make a full charge with a slow charge.)
- 06. Timed shutdown**-portable power station supports the timing shutdown function. Enter the shutdown preset time to realize the

AC OUTPUT VERSION

The AC output panel of this product is one of the following four specifications. Please operate the product according to the Graphics and examples.

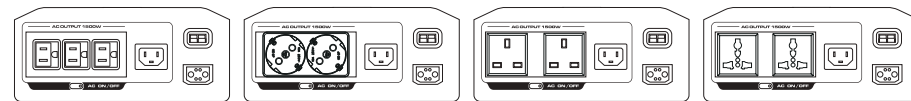

US/Japan AC output Version

EU AC output Version

UK AC output Version

Universal AC output Version

HOW TO RECHARGE P15 PORTABLE POWER STATION

P15 portable power station has three charging modes: AC charging port, which can charge the home power grid market electricity (Example 1), Anderson port that can be charged by car charging (Example 2), The P15 portable power station can also be charged through a solar panel (Example 3).

※ The P15 portable power station can also output electric power while charging.

Example 1:

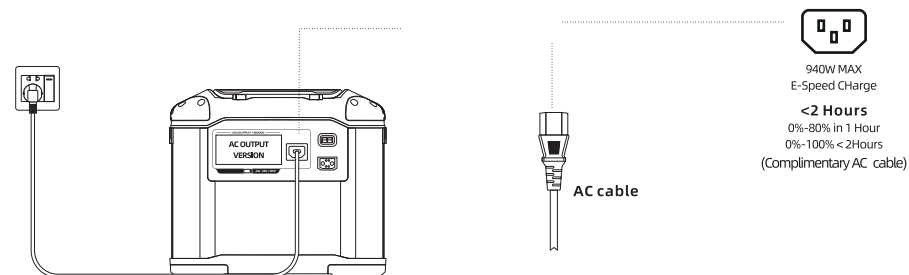

Example 2:

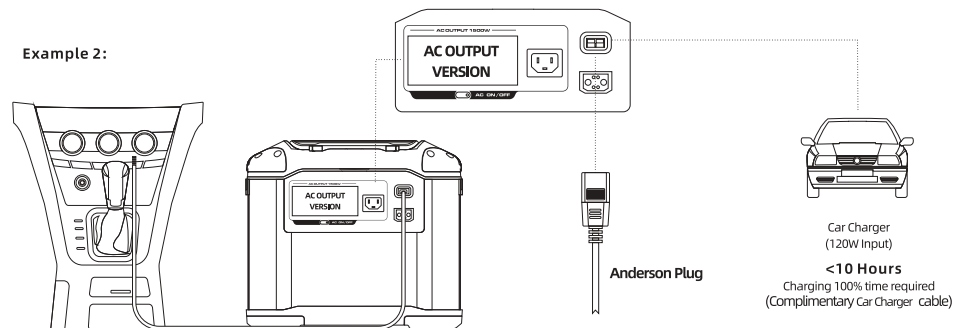

Example 3:

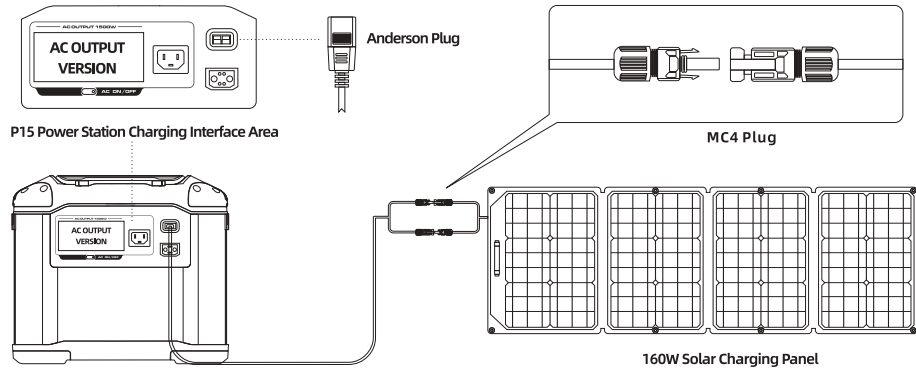

Example 3-1:

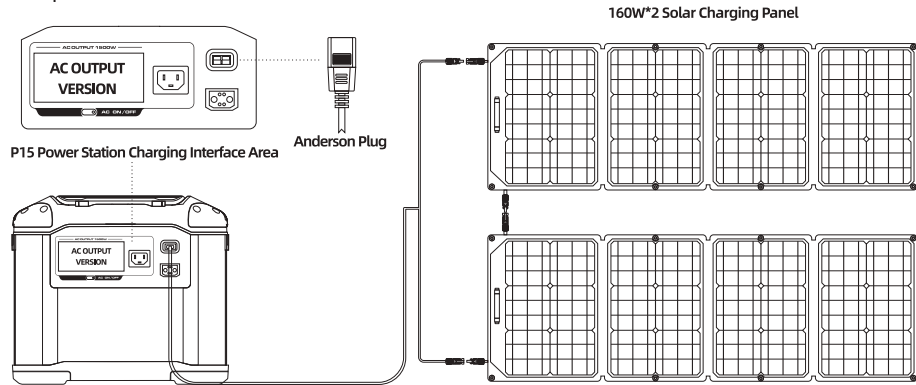

E-UPS FUNCTION INTRODUCTION

The P15 portable power station has the E-UPS function, which means that you can connect to the AC power supply on the wall while using the AC socket of the P15 portable power station (when the AC power is from the power grid, not the battery). When the power grid suddenly cuts off, <30ms can automatically switch to the P15 portable power station battery supply mode. However, this function is a non-professional UPS function, which does not support 0ms switch. Do not connect to the equipment requiring high uninterrupted power supply, or please confirm whether it is compatible after repeated testing. If the equipment is not operated by the prompt operation, or data is lost, the company will not be responsible. (For example, data servers and workstations, which will otherwise affect your machine experience.)

The user can connect the AC charging line on the serial-P15 portable power station to the municipal power grid, and then insert the electrical equipment into the AC output port of the P15 portable power station. Turn on the AC switch and can automatically switch to the E-UPS mode. When the power grid is powered off, the P15 portable power station can continue to use battery power to power your equipment (as shown in the figure below).

The E-UPS function of P15 portable power station only supports the use of total power of 1500W or below. Do not exceed the specified power to avoid abnormal equipment operation or data loss. Our company is not responsible. E-UPS function can only be met only when one P15 portable power station is connected in the following diagram, and multiple P15 portable power stations do not have E-UPS function when connected.

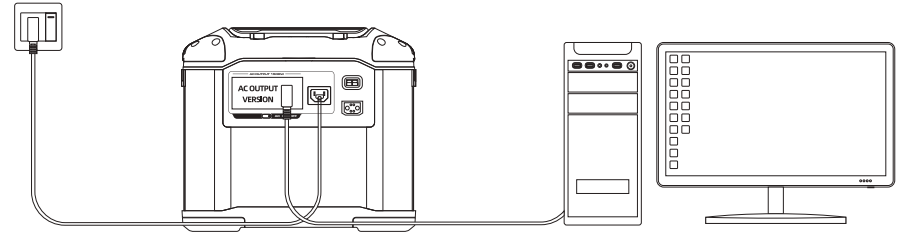

2、Multi-machine series mode guide (recommended by heavy use, all machines must be full power)

Users can connect multiple (2 MAX) full-power P15 portable power stations together in series through AC lines, so that users can obtain multiple times of continuous energy, and meet the needs of professionals for high-power electrical appliances, requiring super-long working time. In this mode, multiple P15 portable power stations do not connect the AC charging line to the power grid, otherwise the machine will have overcurrent protection (<20A), and put the P15 portable power station into the home power grid for a charge separately. It is recommended that the charging quantity should not exceed two at the same time, otherwise it will bring excess load to the home power grid. Using this function, we need to define the division of labor of the following multiple machines. You can choose any P15 portable power station as the host, and the other several machines are slave 1 and terminal slave. Then connect one of your AC line plugs to the AC output of the host and the other end to the AC output of the slave 1. Then one of your AC line plugs is connected to the AC output port of the slave 1, the other end to the AC input port of the terminal, and so on. After the connection is complete, open the AC switch for all machines. Multi-machine series mode is thus completed. Finally, when all the appliances are connected to the AC outlet of the terminal slave machine, you can experience the convenience of constant super battery life (as shown in the figure below).

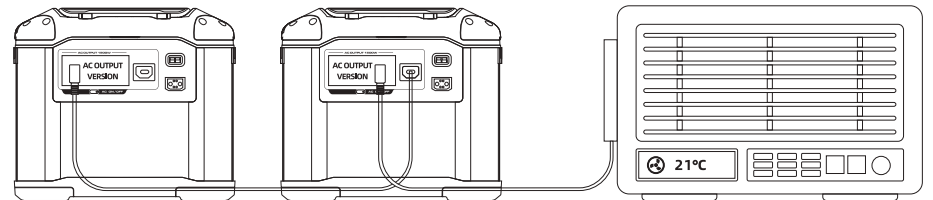

TECHNIAL SPECIFICATIONS

GENERAL SPECS

Size	13x11.2x8.3 Inch (33x21x28.5cm)
N. W.	27 lb (12.1 KG)
Capacity	1008 Wh 50.4V
Testing and Certification	PSE/FCC/CE/ROSH

Output

US/Japan AC output Version	1500W(Surge MAX 2500W)total 110V,50/60Hz
EU AC output Version UK AC output Version	1500W(Surge MAX 2500W)total 220V,50/60Hz
USB-A(x2)	5V/9V/12V, 24W Max
USB-C(x1)	5V/9V/12V/15V/20V , 60W Max
Car Power(x1)	13.6V,10 A, 136W Max

Input

AC Charge Input Power	E-Speed Charge 940W MAX
US/Japan AC Input Voltage	100-120Vac,50/60Hz
EU AC Input Voltage UK AC Input Voltage	220-240Vac,50/60Hz
Solar Charge Input	10-40V 300W Max
Car charge Input	12V/24V 8A

Battery

Cell Chemistry	NCM
Cell Type	18650
Pack	14S8P,(2.6Ah*3.6V)*(14*8)
Discharge Temperature	4°F~-140°F ± 5°F(-20°C~-60°C ± 3°C)
Charge Temperature	32°F~113°F ± 5°F(0°C~45°C ± 3°C)
Life Span	800 Cycles 80%

E-VSZ MODE INTRODUCTION

The E-VSZ feature of the P15 allows you to use the P15 rated 1500-2500W AC inverter without having to buy custom appliances for mobile storage. Traditional reverse electrical appliances, as long as after using electrical appliances with more than the rated power, the equipment will appear to overload, resulting in such electrical appliances can not be used. The E-VSZ function of the P15 is to use electrical appliances between 1500 and 2500W, and please note when using them:

- 1.AC output can not use electrical equipment exceeding 1500 when connected to the home grid, otherwise low voltage protection will trip during use.
- 2.Do not use the electrical equipment with more than 1500 under the charging state.
- 3.When using the rated electrical equipment of 1500-2500W, only one can be connected at most, so as to avoid affecting the use effect of electrical appliances in multiple appliances due to voltage changes.

※ The E-VSZ function is not suitable for all electrical appliances. Some electrical equipment with strict voltage requirements from 1500W to 2500W cannot be used. Please confirm the power consumption before use, so as not to affect the experience. Air conditioners and air compressors are not recommended to avoid damage to electrical appliances. It is recommended to use heating electrical equipment with a rated power of 1500-2500W, such as hair dryer, electric kettle, induction cooker, coffee machine and other equipment.

FAQ

How to use P15 portable power station:

Please use it within the allowable operating temperature of the P15 portable power station. Use outside the optimum operating temperature may cause the P15 portable power station to go beyond its safe and effective operating limits. Do not immerse the host in water, the P15 portable power station does not have the waterproof function. Please be waterproof and do not fail the warranty clause. Continued use of high-power electrical output may cause excessive temperature protection due to too high host temperature. Please wait about 30-60 minutes before use or charging.

How to Charge the P15 portable power station:

1. The P15 portable power station must be charged with an officially designated charging cable. We will not be responsible for all the consequences of charging the non-original parts.
2. When charging, please place the machine on the surrounding flat ground without flammable and combustible substances. Please watch the product on site when charging to prevent accidents.
3. After continuous full load discharge, if the product battery is in a high temperature state, it's recommended to be charged after the machine is reduced to room temperature. Otherwise, charging may be prohibited. The rechargeable ambient temperature of the battery is 0°C -45°C, and the ideal charging ambient temperature (22-28°C) can significantly extend the service life of the battery.

How to store and transport P15 portable power stations:

1. Please store the P15 portable power station out of the reach of the children. If children accidentally swallow parts, seek medical help immediately.
2. When the equipment power is low, please charge before storing it. Otherwise, long and low power storage may cause damage to the battery inside the product. If the device is seriously insufficient and idle for too long, the battery will enter the deep sleep mode. If the battery needs to be awakened from the deep sleep, choose the slow charge mode for the machine until full. To extend battery life, we recommend that you discharge at least every three months and charge with slow charges.
3. It is forbidden to place the P15 portable power stations close to the heat source, such as the direct sunlight in the car, the fire source, or the heating furnace.
4. The environment for the storage equipment shall be kept dry. Do not refer the machine to the water or where it may leak.
5. It is forbidden to store or transport the equipment together with eyeglasses, watches, metal necklaces, hairpins, or other metal objects.

Product battery waste treatment:

1. Before placing the device in the designated battery recycling bin, be sure to completely empty the battery of the device. Batteries are hazardous chemicals and should not be disposed of in ordinary trash. Please observe local battery recycling and disposal laws and regulations for details.
2. The battery cannot be started after overdischarging. Do not remove the power supply by yourself. Please dispose of as waste.

How to maintain the P15 portable power station:

1. conditions of over 60°C or less than -20°C.
2. If the machine is left idle for a long time, it will affect its performance.
3. Please recharge and discharge it at least once every three months to keep the battery active.
4. P15 portable power stations are widely used and may therefore simple cleaning to be required from time to time. Please wipe it with a dry nonfrosted cloth. If the surface is too dirty, we recommend cleaning up for your phone and computer screens. Do not expose the product to large quantities of water!

Product Warranty Card

Name:	Tel:		
Address:			
Purchase Date:	Day	Month	Year
Warranty Effective Date:	Day	Month	Year
SN:			
Purchase channel:			

DATE	Maintenance Record



Email: info@flashfishtech.com

For technical support, after-sales please feel free to contact us

Flashfish Team:

Website: www.flashfishtech.com (more contact info could be found on our website)



PACKING LIST

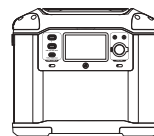

P15 Portable Power Station

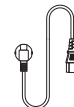

1.5m AC Cable (Input)



1.5m Car Charge Cable (Input)

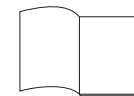

User Manual & Warranty Card

OPTIONAL ACCESSORIES

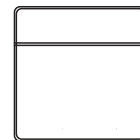

P15 Bag

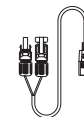

Solar charge Cable (MC4 to Anderson Input)

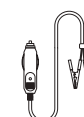

Car battery Clamps (Output)