



**Hidro
Pnevmo
Tehnika**

3, Vojeli St., Kazanlak, Bulgaria
Tel.: +359 431/ 62 228
Fax : +359/ 62 019
e-mail : info@hpt-bg.com
www.hpt-bg.com

VALVE BLOCK

BPC5/ ...

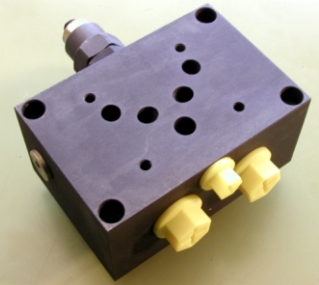

All performances and calibration are carried out by using hydraulic oil with viscosity approx. 46 cSt at 50 °C
Temperature range: -20 °C...+80 °C
Filtration absolute: 20 µm

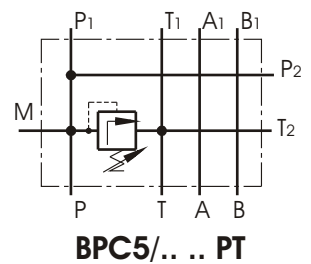
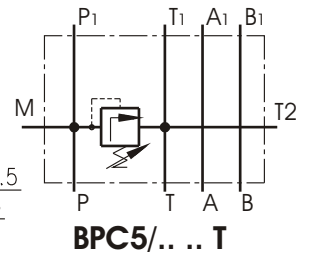
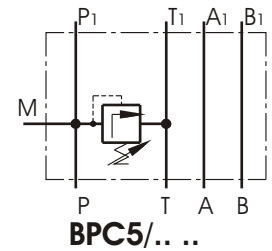
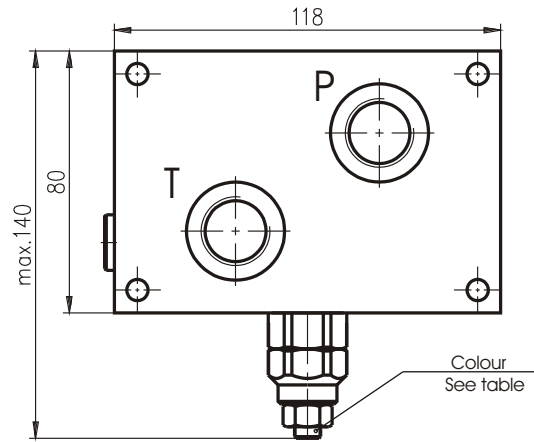

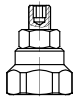
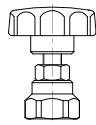
Code	Adjustments
A	Leakproof hex. socket screw 
B	Handknob and locknut 

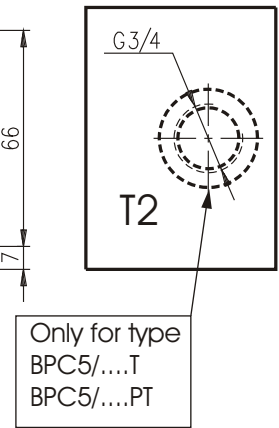
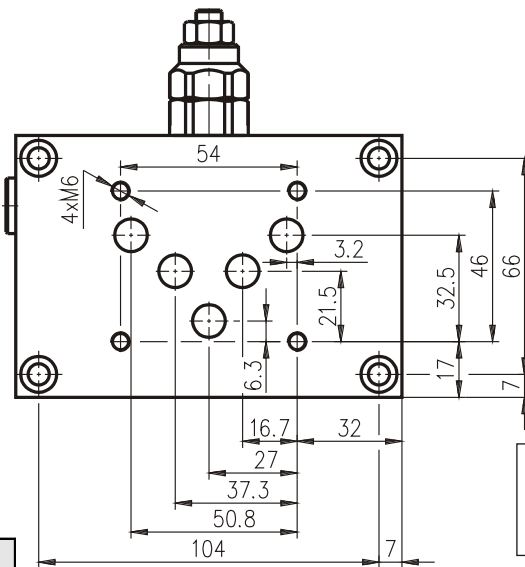
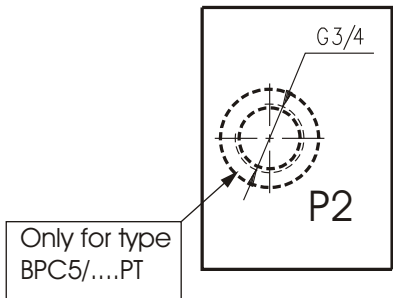
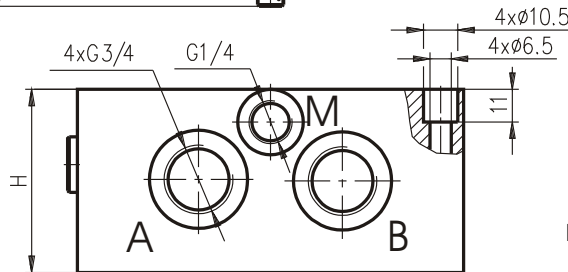

Pressure range			
Code	Standard setting bar (Q= 5l/ min)	Adj. pressure range bar	Colour
10	80	10..100	White
25	180	30..250	Yellow
35	250	70..350	Black

Type	P _{max.} bar	Q _{max.} L/ min	H mm
	BPC5/	350	40
BPC5/ T	350	40	58
BPC5/ PT	350	40	68

ORDERING CODE

BPC5 / 25 A T

