

SONAR 5K WPV Quick Guidance

Contents

SONAR 5K WPV Guidance_____	1
Part 1. Connection for SNA 5K WPV_____	2
Part 2. Monitor System Guidance_____	4
Part 3. LCD Display and Setting_____	4
Part 4. SONAR 5K Working Mode Introduction_____	18
Part 5. Error/Warning List_____	20

Part 1. Connection for SNA 5K WPV

1. System Connection

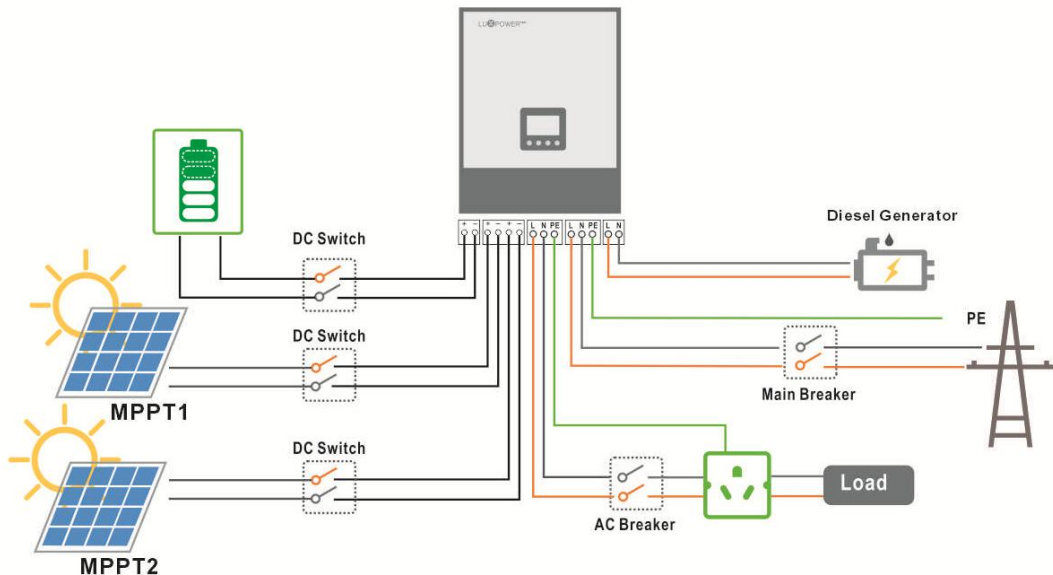

Normally the off grid inverter need to connect

- **Solar panel:** SONAR support two different strings input, the input voltage range is **100V-480V**, please keep mind that the PV1 and PV2 voltage can not higher than 500V, otherwise, it will damage the inverter.
- **Battery input:**
 - **Battery Type:** SONAR support both Li battery and lead acid battery. For Li battery, SONAR is compatible with Pylontech and Dyness battery, you can choose the battery type and brand in the monitor system or LCD after power on.
 - **Battery Voltage:** The battery voltage input range is **40V-60V**, if battery voltage higher than 60V, inverter will report error.
 - **Battery Charge Current:** The totally max charge current is **140A**. The max solar charge current is **100A**, max AC charge current is **60A**.
 - **Battery Discharge Current:** The max discharge current is **120A**.
- **AC input:** The AC input voltage range is 110V-280V, max AC charge current is 100A
- **Off grid output:**
 - 5000w nominal
 - 115% overload 10 seconds
 - 150% overload 5 seconds
 - 10000VA inrush power
 - can be parallel and extend to 50kW(support this function since 2021)
- **Genset input:** There is separated input for genset, the genset can be used charge the battery and take the load. AC and genset can input at the same time, inverter

will use AC first if there if AC input.

2. Interface of SONAR

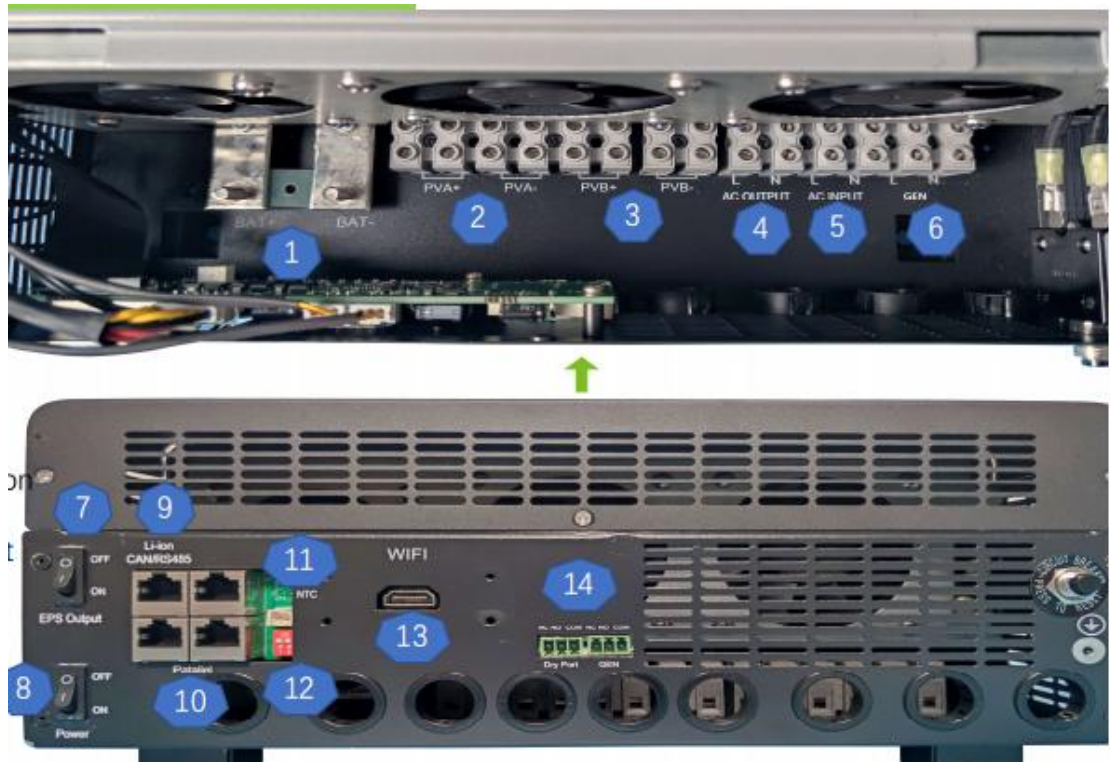

1. Battery Cable Interface
2. Solar Input String 1
3. Solar Input String2
4. Off Grid Output
5. AC Grid Input
6. Generator Input
7. Off grid Output Switch, when turn off it, there will be no output in the output terminal, but the system can still charge the battery
8. System Power Switch, the whole system will shutdown if the switch is off.
9. Battery communication cable
10. Parallel cable communication interface
11. Temperature sensor input
12. Balance resistor PIN for paralleling communication
13. Wifi plug in interface
14. Dry contact/Genset control port

Part 2. Monitor System Guidance

Step 1. After connection of the cables, the next step is to setup wifi to monitor the system and update the firmware to latest version if necessary.

For Endusers: Please refer the document 'Monitor system setup for endusers' for register an enduser account and wifi password setting.

For Distributors: Please refer the document ' Monitor system setup for Distributors' for add datalog in the system and wifi password setting.

Step2. Website settings

Users can set all the parameters by website, for the setting explanations, please refer ' Off grid settings'.

Part 3. LCD Display and Setting

3.1 Inverter Status Display

➤ Normal status

There is a smile on the LCD which means the inverter is running normally, the number 40 means inverter is in the 40 status.

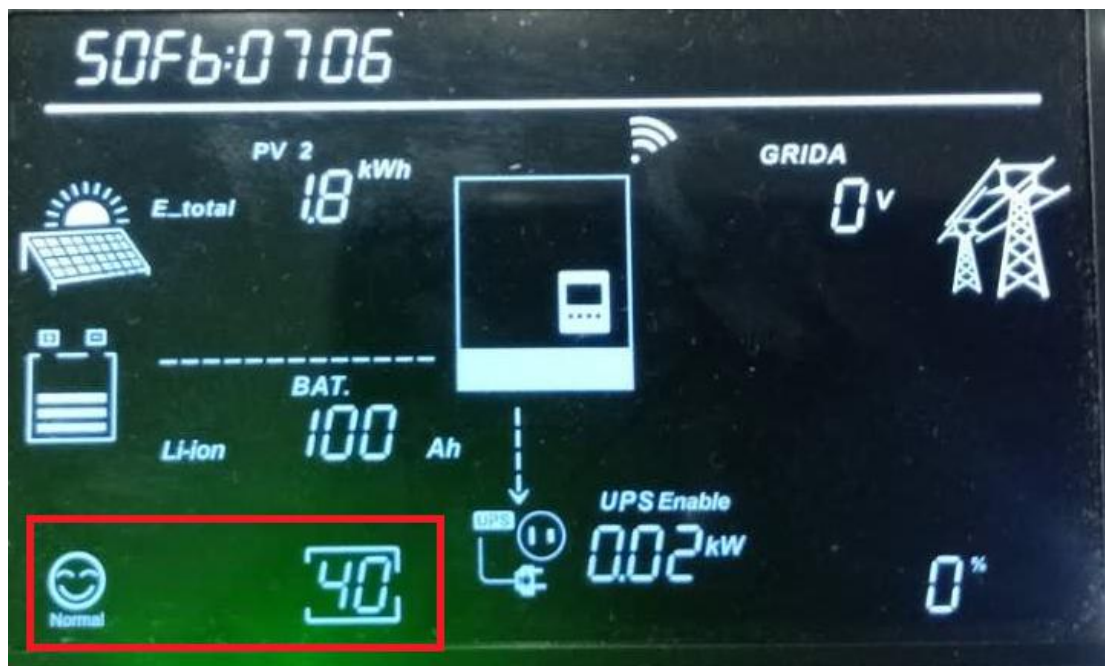

➤ Warning Status

There is a warning face, and number 29 next to it, which means warning29



➤ **Fault Status**

There is a fault face, and number 21 next to it, which means Fault 21



➤ **Download firmware**

When we update firmware, the LCD will show update progress on the LCD as below, the download percent is 33% in the below picture

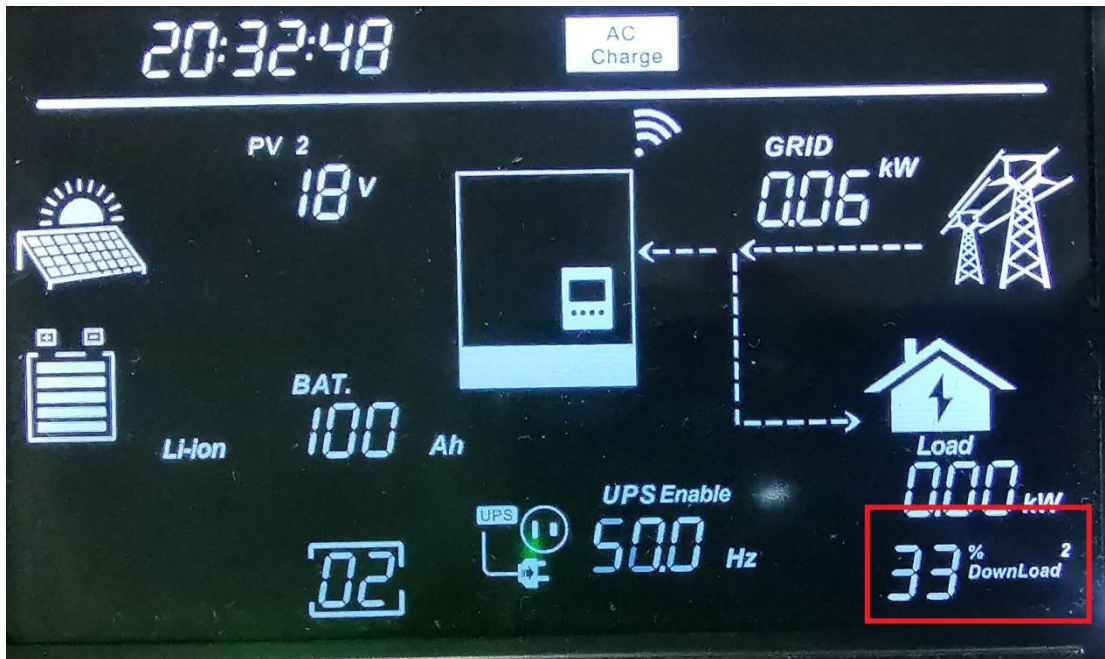

3.2 Other Information Display



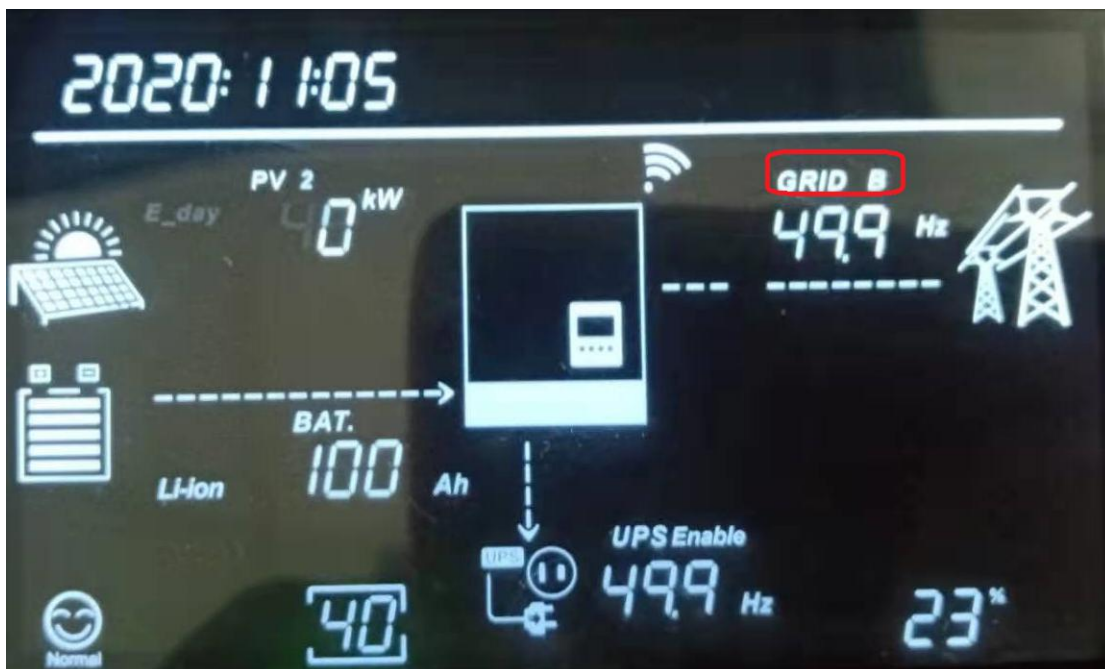

- **Grid A:** when display 'GRIDA', it means the information is about AC utility
- **Grid B:** when display 'GRIDB', it means the information is about Genset











- The percent display on the right down corner means the load percentage

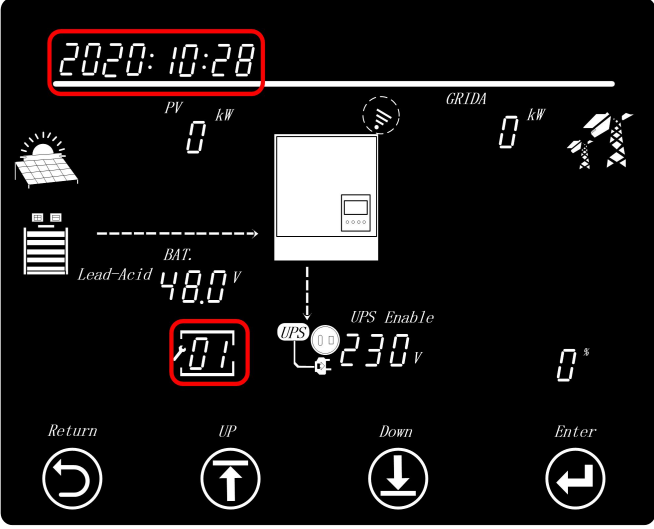
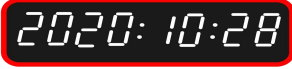

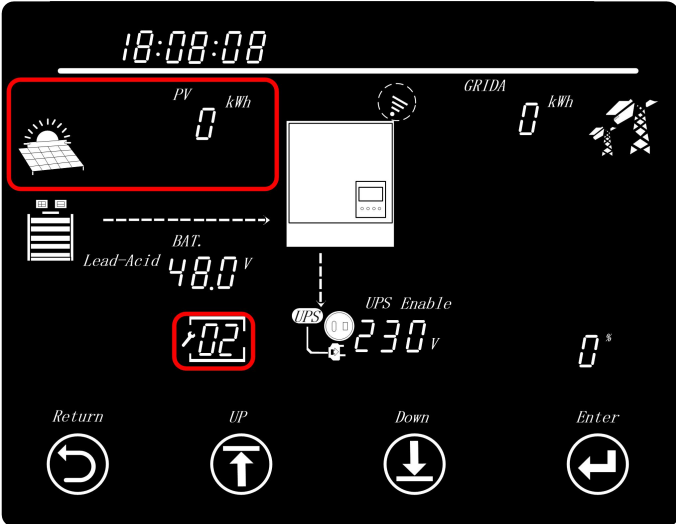

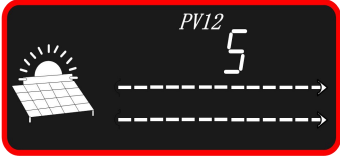

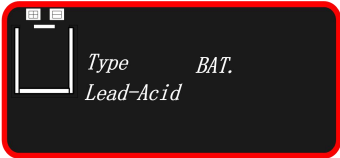
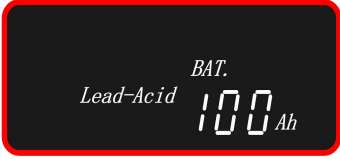
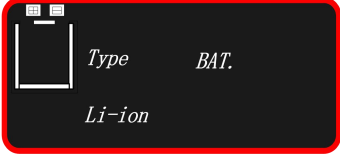
3.3 LCD Settings



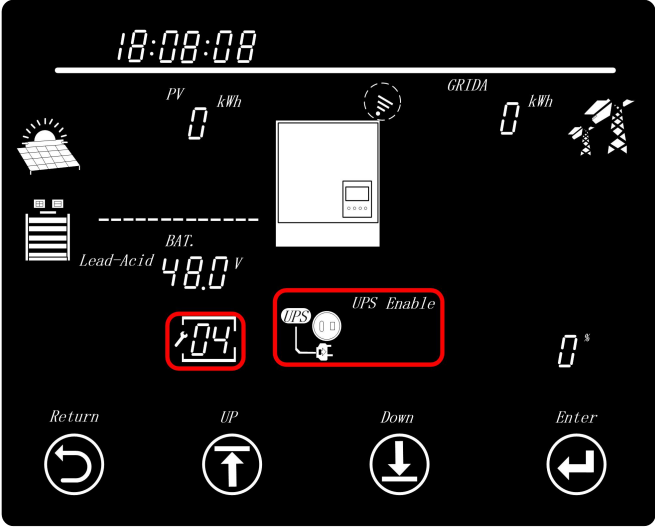

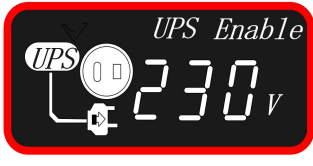
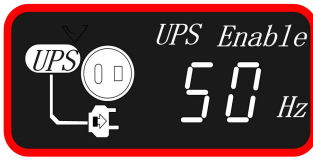
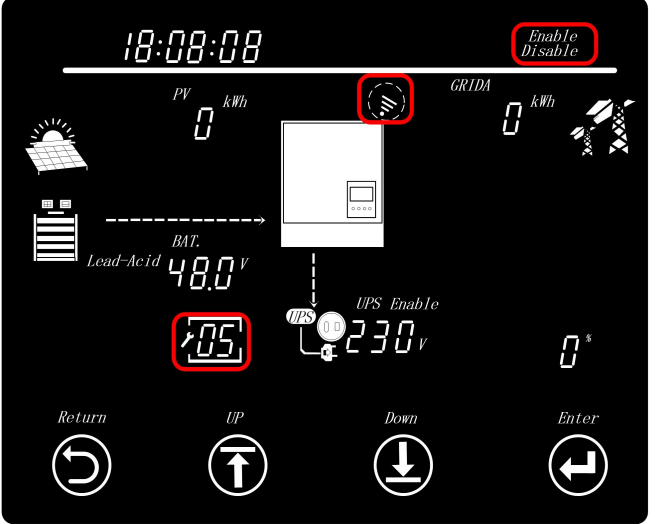
Button	Function
<i>Return</i> 	return, enter LCD setting mode
<i>UP</i> 	Go up
<i>Down</i> 	Go down
<i>Enter</i> 	Enter



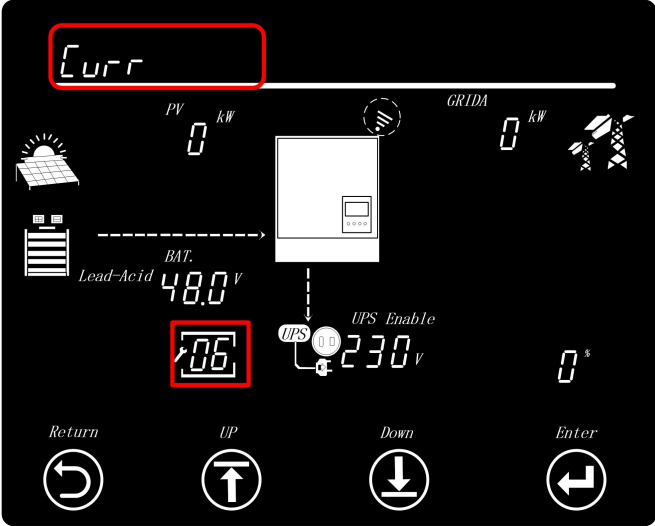

- Step1: After touch **Return** button , the unit will enter setting mode.
- Step2: Touch **UP** or **Down** button to select setting index from 1 to 15.
- Step3: Then touch **Enter** button to set this item
- Step4: Touch **UP** or **Down** button to change the settings
- Step5: Touch **Enter** to confirm the setting or **Return**
 the setting list is as below

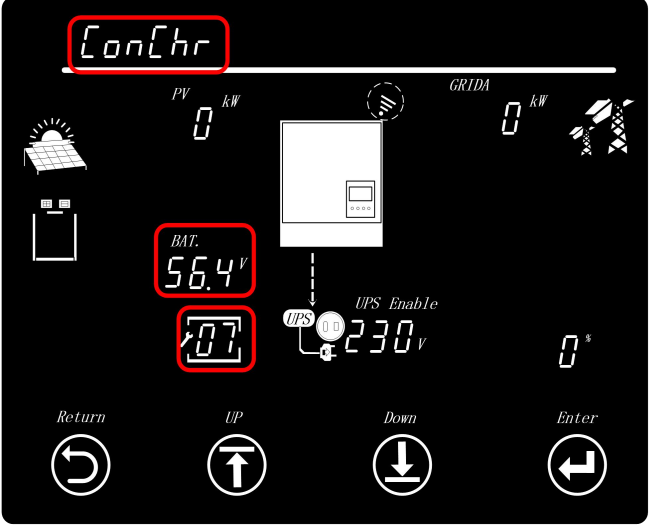



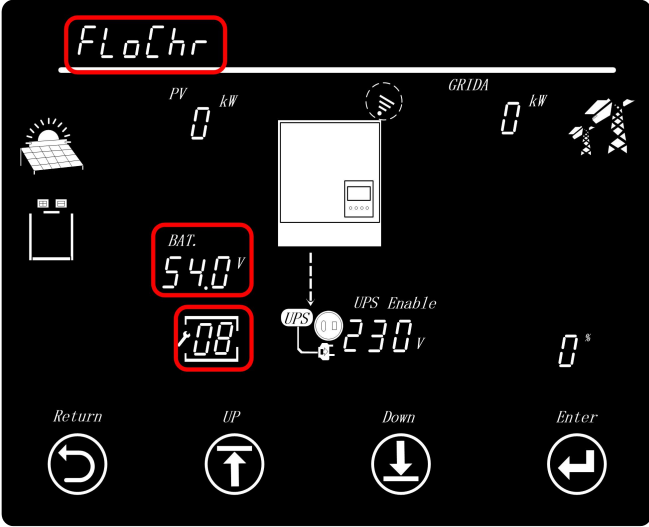

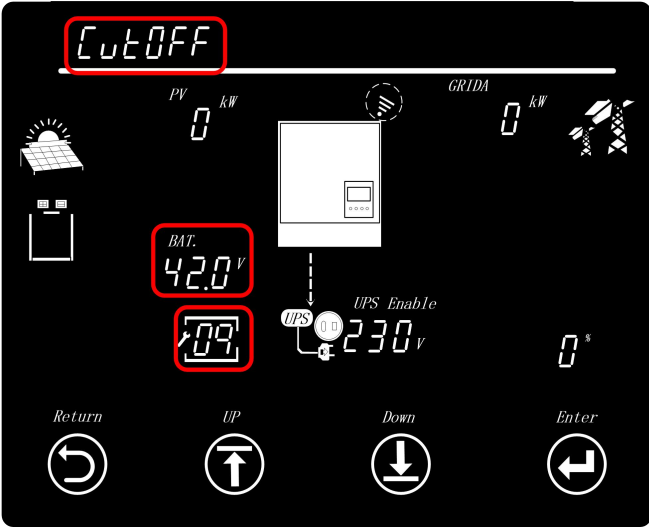
Index	Description	Setting Option	
01	Setting time		
		Setting Year/Month/day	
		Year default 2017, range 2017~2099 Month default 01, range 01~12 Day default 01, range 01~31	Setting hour/minute/second
		Hour default 00, range 00~24 Minute default 00, range 00~59 Second default 00, range 00~59	
02			



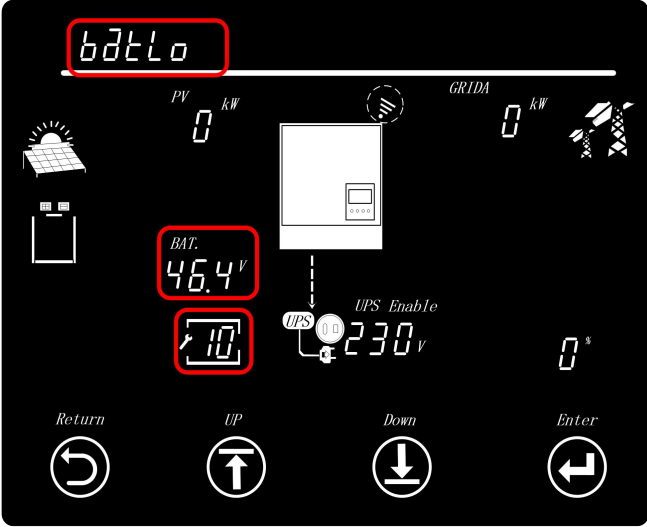

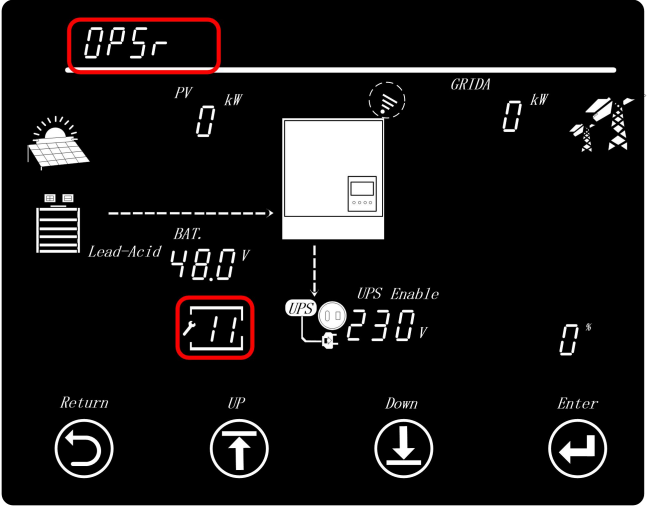

	PV input mode setting		
		Default in two independent Mppts mode	
		Setting two mppts in parallel mode	
03	Battery type setting	Lead-acid battery type choose setting	
		Lead-acid battery capacity setting Capacity default 100Ah , range 50Ah~400Ah	
		Lithium battery type choose setting (only suitable when communicated with BMS)	
		Lithium brand setting 0----- Standard Battery 1----- not used 2----- Pylon Battery 3----- reserve 4-----reserve 5----- reserve 6----- Lux Battery 7----- reserve 8----- Dyness Battery 9----- reserve 10----- reserve 11----- Merit Battery 12----- reserve 13----- reserve 14----- WECO Battery 15~18 not used	



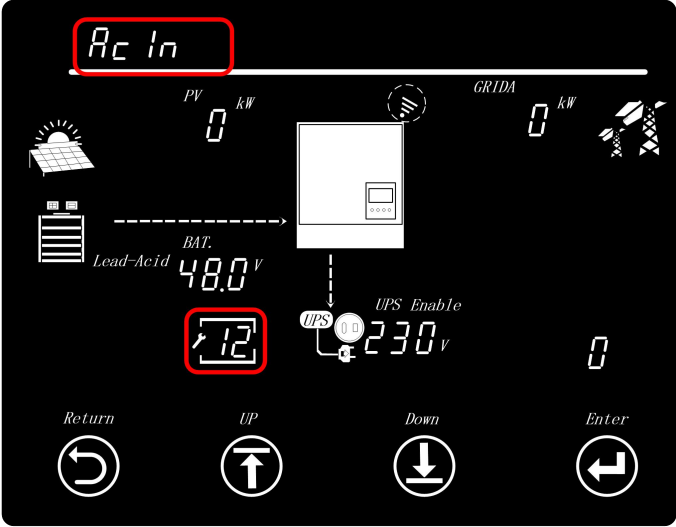

<p>04</p>	<p>AC Output voltate and frequency of EPS setting</p>		
		<p>AC Output voltage setting 208Vac 220Vac 230Vac(Default) 270Vac</p>	
		<p>AC Output frequency setting 50Hz (Default) 60H</p>	
<p>05</p>	<p>Buzzer enable setting</p>		
		<p>Buzzer enable(Default)</p>	
		<p>Buzzer Disable</p>	

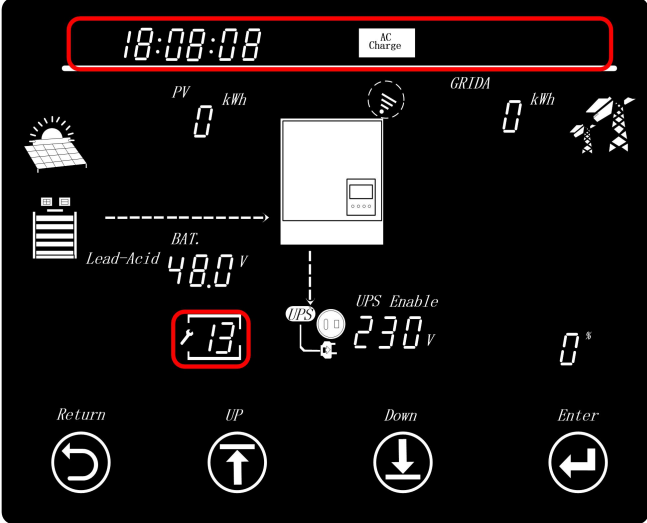



<p>06</p>	<p>Curr:Totoal charge current setting (Maximum charging current: set total charging current for solar and utility chargers. (Max. charging current = utility charging current + solar charging current))</p>	<div style="display: flex; flex-direction: column;">  <div style="display: flex; justify-content: space-between; align-items: flex-start; padding: 5px;"> <div data-bbox="576 745 890 958"> <p>Totoal charge current setting Setting range :10A~140A Default: 110A</p> </div> <div data-bbox="890 745 1329 958">  </div> </div> </div>
<p>07</p>	<p>ConChr:CV voltage setting (Only in Lead-acid battery type)</p>	<div style="display: flex; flex-direction: column;">  <div style="display: flex; justify-content: space-between; align-items: flex-start; padding: 5px;"> <div data-bbox="576 1516 890 1684"> <p>Setting range: 50.0-59.0Vdc Default: 56.4V</p> </div> <div data-bbox="890 1516 1329 1684">  </div> </div> </div>



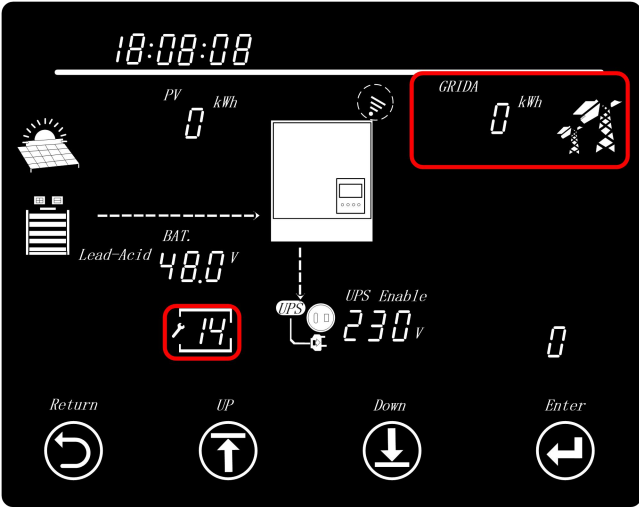
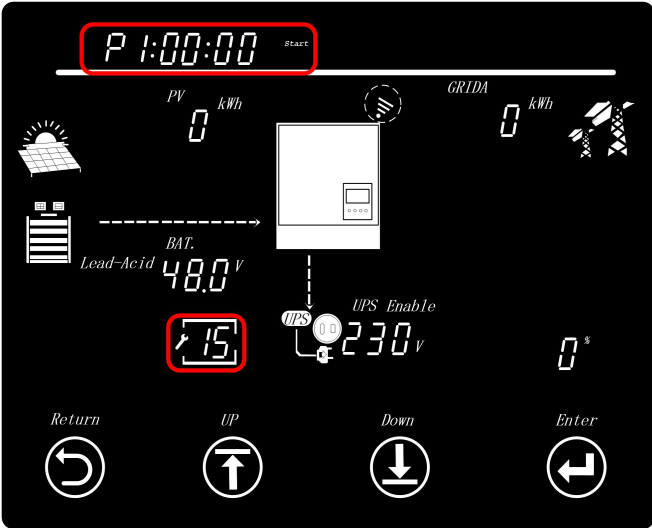

<p>08</p>	<p>FloChr: Floating charging voltage setting (Only in Lead-acid battery type)</p>	 <p>The main LCD display shows the menu 'FloChr' at the top. Below it, 'PV kW' and 'GRIDA kW' both show '0'. The battery voltage 'BAT.' is set to '54.0 V'. The 'UPS Enable' setting is '230 V'. At the bottom, there are four navigation buttons: 'Return', 'UP', 'Down', and 'Enter'.</p> <p>Setting range: 50.0-56.0Vdc Default: 54.0V</p>  <p>The inset LCD display shows 'BAT.' and '54.0 V'.</p>
<p>09</p>	<p>ConChr: CV voltage setting (Only in Lead-acid battery type)</p>	 <p>The main LCD display shows the menu 'CutOFF' at the top. Below it, 'PV kW' and 'GRIDA kW' both show '0'. The battery voltage 'BAT.' is set to '42.0 V'. The 'UPS Enable' setting is '230 V'. At the bottom, there are four navigation buttons: 'Return', 'UP', 'Down', and 'Enter'.</p> <p>Setting range: 40.0-50.0Vdc Default: 42V</p>  <p>The inset LCD display shows 'BAT.' and '42.0 V'.</p>

<p>10</p>	<p>batLo:Battery low switch to UTI setting</p>	
<p>Setting range: 44.4-46.4Vdc Default: 46.4V</p>		
<p>11</p>	<p>OPsr:Priority output source setting</p>	
<p>AC First</p>		
<p>Battery First</p>		
<p>PV First</p>		

<p>12</p> <p>AcIn:AC voltage range setting</p>		
	<p>Unity AC Input voltage range : 90Vac~280Vac</p>	
	<p>AC Output voltage range : 170Vac~280Vac</p>	
	<p>Generator Input voltage range : 80Vac~280Vac</p>	
<p>13</p> <p>AC charge setting (The setting process must enable the AC charging function, confirm the full battery SOC value, and set the confirmation time period 1, 2, 3 to truly complete the AC charging function setting)</p>		
	<p>AC Charge function: Disable(Default)</p>	
	<p>AC Charge function: Enable (Touch "Enter" button to set ac charge parameter)</p>	

		Setting AC Charge current: 30A(Default) 40A 50A 60A	
		Setting AC Charge to battery SOC: Range:0%~100% Default:100%	
		Setting AC Charge time of 1 start: Range:00:00~23:59 Default:00:00~00:00	
		Setting AC Charge time of 1 end: Range:00:00~23:59 Default:00:00~00:00	
		Setting AC Charge time of 2 start: Range:00:00~23:59 Default:00:00~00:00	
		Setting AC Charge time of 2 end: Range:00:00~23:59 Default:00:00~00:00	
		Setting AC Charge time of 3 start: Range:00:00~23:59	
		Setting AC Charge time of 3 end: Range:00:00~23:59 Default:00:00~00:00	

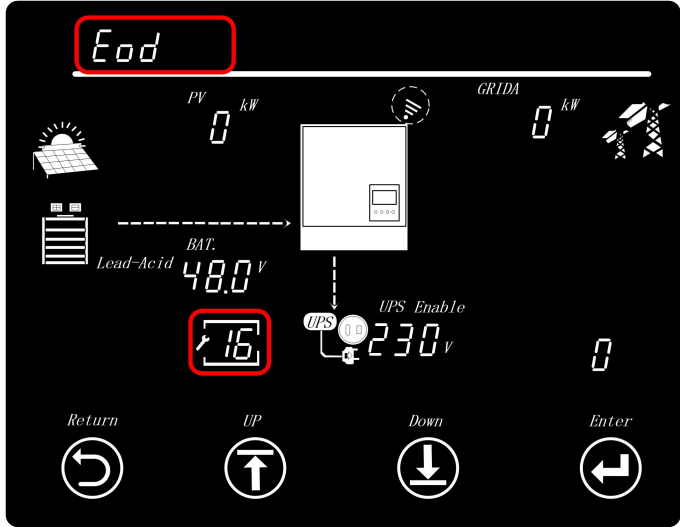
<p>14</p>	<p>Utility source(AC Input) to take Load setting</p>	
<p>15</p>	<p>Utility source(AC Input) to take Load time setting</p>	<div style="display: flex; flex-direction: column;"> <div style="margin-bottom: 10px;">  </div> <div style="margin-bottom: 10px;"> <p>Setting time of 1 start: Range:00:00~23:59 Default:00:00~00:00</p> </div> <div style="margin-bottom: 10px;">  </div> <div style="margin-bottom: 10px;"> <p>Setting time of 1 end: Range:00:00~23:59 Default:00:00~00:00</p> </div> <div style="margin-bottom: 10px;">  </div> <div style="margin-bottom: 10px;"> <p>Setting time of 2 start: Range:00:00~23:59 Default:00:00~00:00</p> </div> <div style="margin-bottom: 10px;">  </div> <div style="margin-bottom: 10px;"> <p>Setting time of 2 end: Range:00:00~23:59 Default:00:00~00:00</p> </div> <div style="margin-bottom: 10px;">  </div> </div>

		Setting time of 3 start: Range:00:00~23:59	
		Setting time of 3 end: Range:00:00~23:59 Default:00:00~00:00	
16	Eod:Ending SOC of discharge setting		
		Ending SOC of discharge setting: Range:10%~90% Default:15%	

Part 4. SONAR 5K Working Mode Introduction

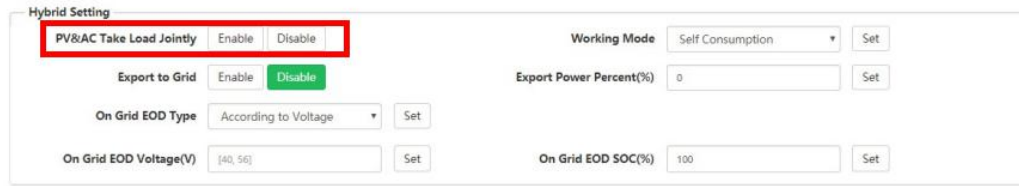

Hybrid Setting

PV&AC Take Load Jointly: Enable **Disable**

Export to Grid: Enable **Disable**

On Grid EOD Type: According to Voltage

On Grid EOD Voltage(V): [40, 56]

Working Mode: Self Consumption

Export Power Percent(%): 0

On Grid EOD SOC(%): 100

SONAR can work as traditional off grid inverter or as a hybrid inverter.

➤ Working as a traditional off grid inverter

When disable PV&AC take load jointly, the inverter will work as a traditional off grid inverter.

In this situation, inverter either use solar+battery take load or use AC take load.

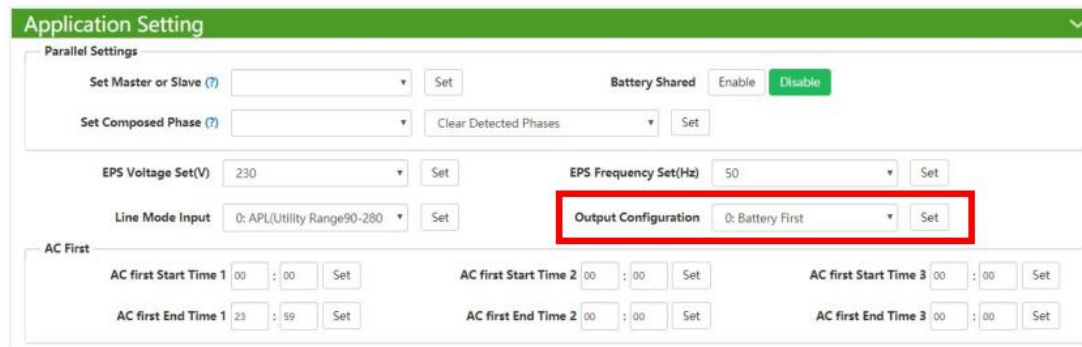

Application Setting

Parallel Settings

Set Master or Slave (?): [] Set

Battery Shared: Enable **Disable**

Set Composed Phase (?): [] Clear Detected Phases [] Set

EPS Voltage Set(V): 230 Set

EPS Frequency Set(Hz): 50 Set

Line Mode Input: 0: APL/Utility Range90-280 Set

Output Configuration: 0: Battery First Set

AC First

AC first Start Time 1: 00 : 00 Set

AC first Start Time 2: 00 : 00 Set

AC first Start Time 3: 00 : 00 Set

AC first End Time 1: 23 : 59 Set

AC first End Time 2: 00 : 00 Set

AC first End Time 3: 00 : 00 Set

Output Configuration:

Battery First: Inverter will use battery and solar (if there is) to take the load until battery low, then it will go to utility bypass mode(grid take the load). The picture shows the solar and the battery take load together.

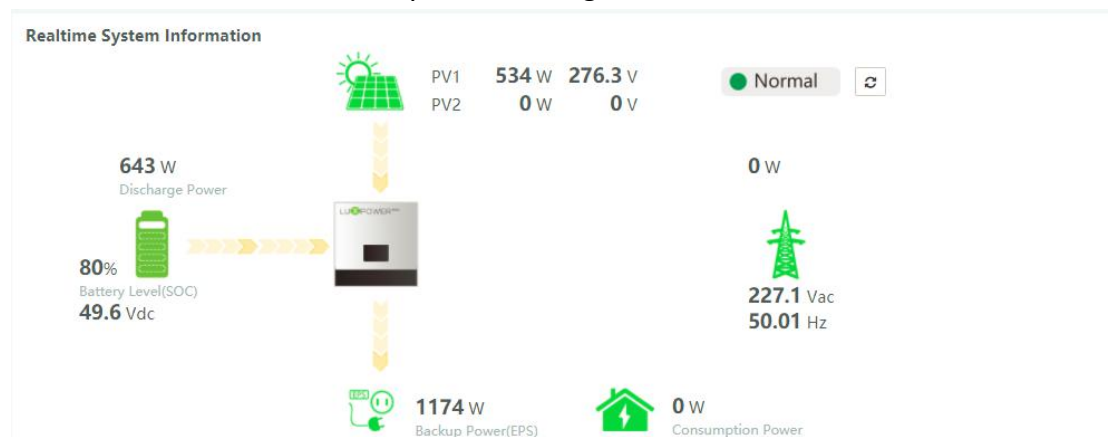

PV First: Inverter will use battery and solar take load together only when there is solar; If there is no solar, inverter will use utility bypass to take the load.

AC First: Inverter use utility bypass to take first, if the utility out of range, it will go to battery mode; Customer need to set the time for AC first when choose this option,

and the rest of the time will use battery and solar to take load.

➤ **Working as a hybrid inverter**

When enable PV&AC take load jointly, the inverter will work as a hybrid inverter, which means solar, battery and grid will take the load together.

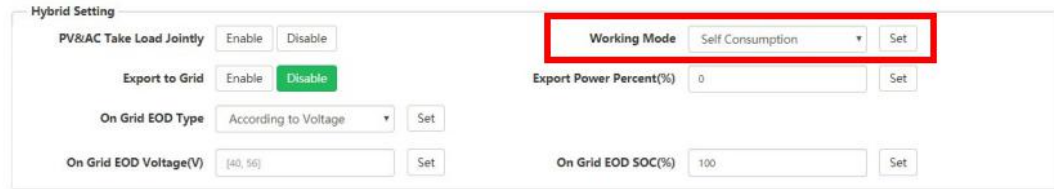

Working mode:

Self Consumption: The inverter will use solar, battery and AC to take load together. Inverter will try to use solar and battery to take load first, if the power from solar and battery is not enough, it will use AC together to take the load.

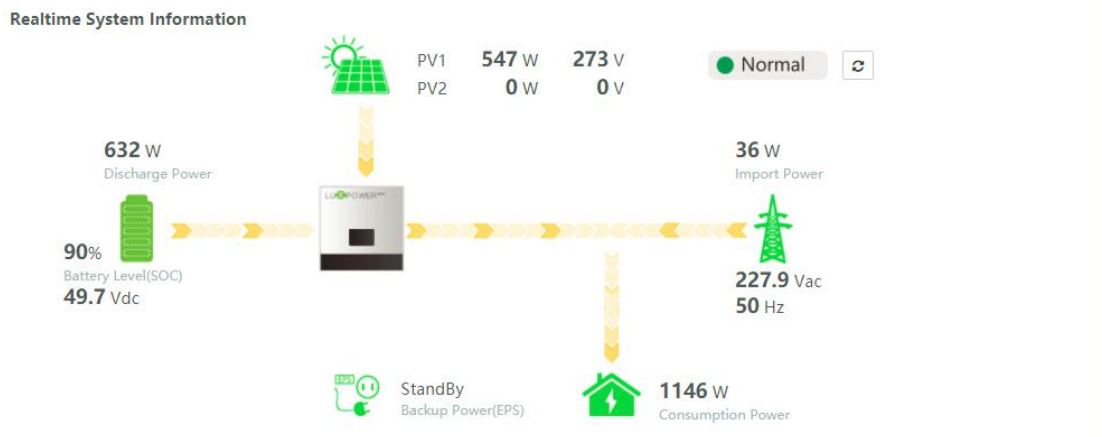

Charge First: The inverter will use solar to charge battery first. If there is more solar power, it will take the load, otherwise system will use AC to take the load

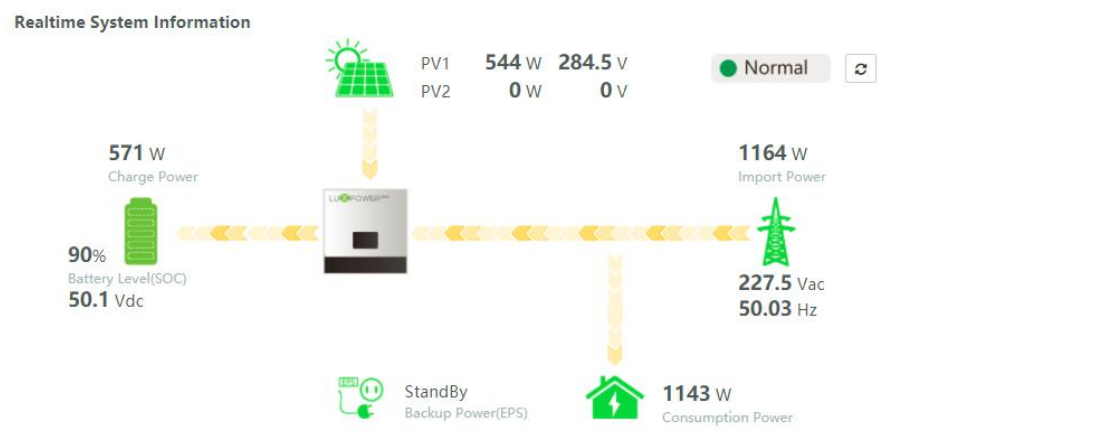

On-grid : when enable export function, the inverter can work as on grid inverter. If solar power is higher than the power (load+power need to charge the battery), the extra power can feed into grid

Realtime System Information

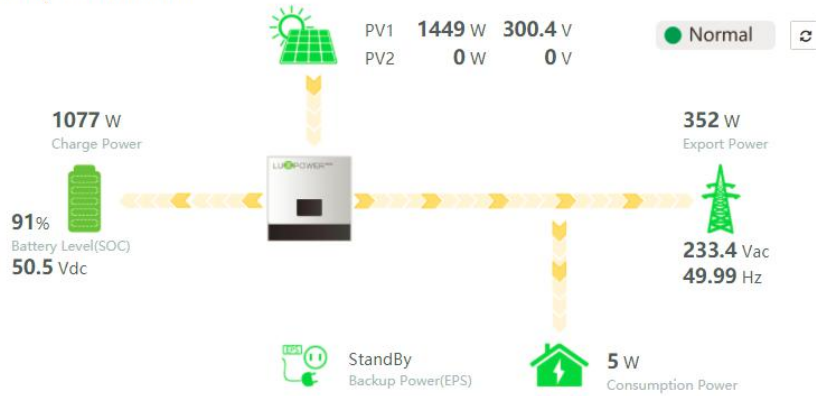

On Grid EOD: when there is grid, battery and solar will take the load until SOC/Vbattery is lower than settings EOD voltage or EOD SOC.

Part 5. Error/Warning List

The failures mainly divided into 5 categories, for each category, the behavior is different:

- **System Failure:** the error system within this failure will stop running.
- **PV Failure:** If a single PV fails, it belongs to the warning level. The solar charger will not work, inverter can still have off grid output from battery or bypass the AC to off grid output.
- **INV Failure:** if a single failure of DC-AC side (inverter) existed, it belongs to the warning level, the DC-AC will not work, the system can still charge the battery and bypass AC to off grid output.
- **Battery Failure:** if a single failure of battery side (inverter) existed, battery can not charge or discharge.

Error List

FaultCode	Fault description	Trouble shooting
E000	Internal communication fault1	Restart inverter, if the error still exist, contact us (DSP&M3)
E001	rsvd	
E002	BatOnMosFail	Restart inverter, if the error still exist, contact us (DSP&M3)
E003	CT Fail	Restart inverter, if the error still exist, contact us (DSP&M3)
E004	rsvd	
E005	rsvd	
E006	rsvd	
E007	rsvd	
E008	CAN communication error in Parallel System	Check CAN cable connection is connected to the right COM port
E009	No master in parallel system	Check parallel setting for master/Slave part, there should be one master in the system
E010	Multi master in parallel system	Check parallel setting for master/Slave part, there should be one master in the system

E011	AC inconsistent in parallel system	Check if AC Connection is same for all inverters in parallel system
E012	Off grid output short circuit	Check if the load is short circuit, try to turn off the load and restart inverter
E013	UPS reserve current	Restart inverter, if the error still exist, contact us
E014	rsvd	rsvd
E015	Phase Error in three phase parallel system	Check if the AC connection is right for three phase system, there should one at least one inverter in each phase
E016	Relay fault	restart inverter, if the error still exist, contact us
E017	Internal communication fault2	restart inverter, if the error still exist, contact us (DSP&M8)
E018	Internal communication fault3	restart inverter, if the error still exist, contact us (DSP&M3)
E019	Bus voltage high	check if PV input voltage is higher than 480V
E020	EPS connection fault	check if EPS and AC connection is in wrong terminal
E021	PV voltage high	Check PV input connection and if PV input voltage is higher than 480V
E022	rsvd	
E023	rsvd	
E024	PVshort	check PV connection
E025	Temperature over range	The internal temperature of inverter is too high, turn off the inverter for 10minutes, restart the inverter, if the error still exist, contact us
E026	Internal Fault	restart inverter, if the error still exist, contact us (Bus sample)
E027	rsvd	
E028	rsvd	
E029	rsvd	
E030	rsvd	
E031	Internal communication fault4	Restart inverter, if the error still exist, contact us (DSP&M8)

Warning List

WarningCode	Warning decription	Trouble shooting
W000	Communication failure with battery	Check if you have choose the right battery brand and communication cable is right, if the warning still exist, contact us

W001	Battery temprature high	Check battery temperature sensor is right connected and the battery temperature is not too high
W002	Battery temprature low	Check battery temperature sensor is right connected and the battery temperature is not too lowa
W003	rsvd	rsvd
W004	Battery failure	Inverter get battery fault info from battery BMS, restart battery, if the warning still exist, contact us or battery manufacture.
W005	rsvd	
W006	rsvd	
W007	rsvd	
W008	Software mismatch	Please contact Luxpower for firmware update
W009	Fan Stuck	Check if the fan is OK
W010	rsvd	
W011	rsvd	
W012	BatOnMos	Restart inverter, if the error still exist, contact us
W013	Overt temprature	The temperature is a little bit high inside inverter.
W014	rsvd	
W015	rsvd	
W016	rsvd	
W017	rsvd	
W018	AC Frequency out of range	Check AC frequency is in range
W019	rsvd	
W020	rsvd	
W021	rsvd	
W022	rsvd	
W023	rsvd	
W024	rsvd	
W025	Battery voltage high	Check if battery voltage is in normal range
W026	Battery voltage low	Check if battery voltage is in normal range, need to charge the battery if battery voltage is low
W027	Battery open	Check if there is output from the battery and battery connection with inverter is OK
W028	EPS Over load	check if EPS load is too high
W029	EPS voltage high	Restart inverter, if the error still exist, contact us
W030	rsvd	
W031	EPS DCV high	Restart inverter, if the error still exist, contact us