

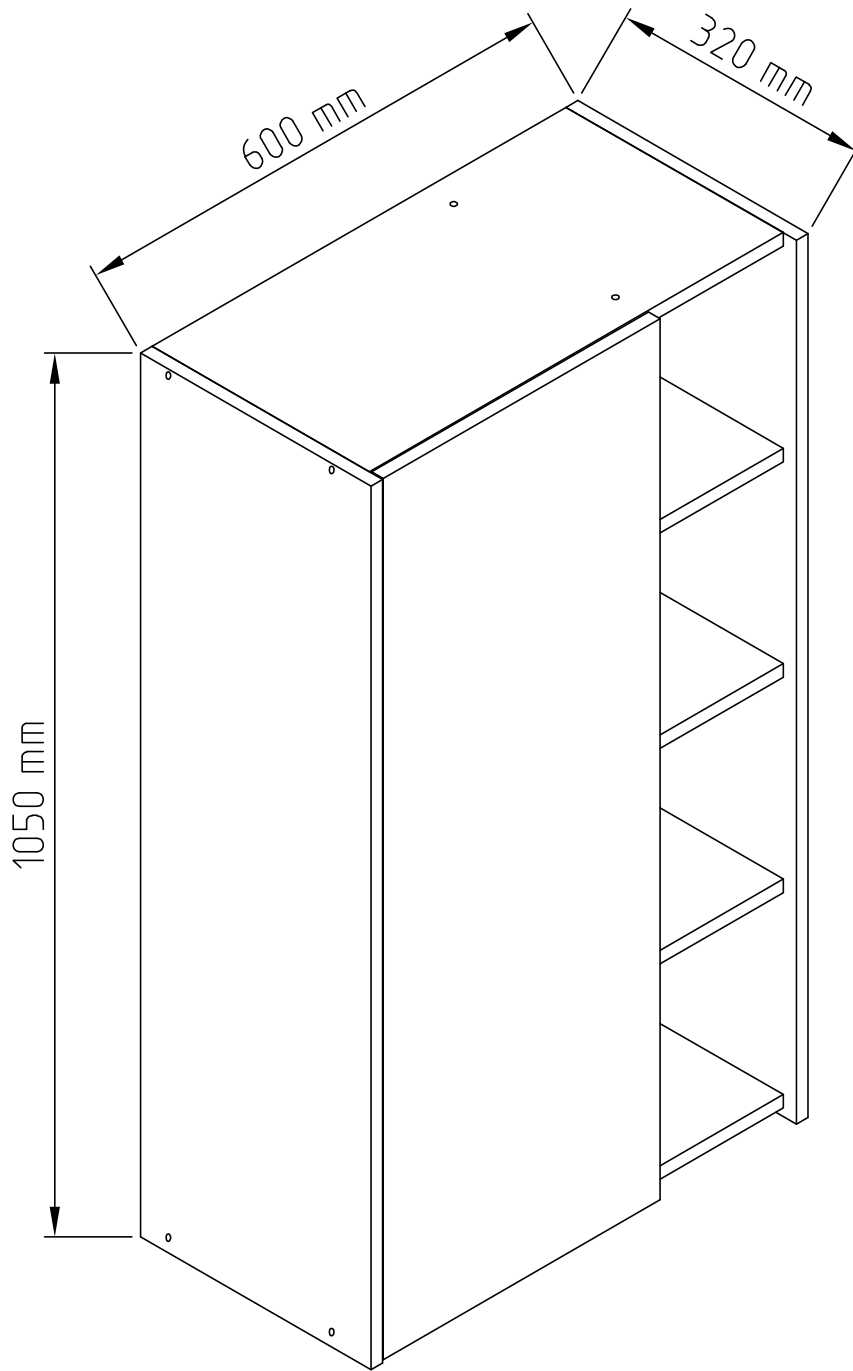

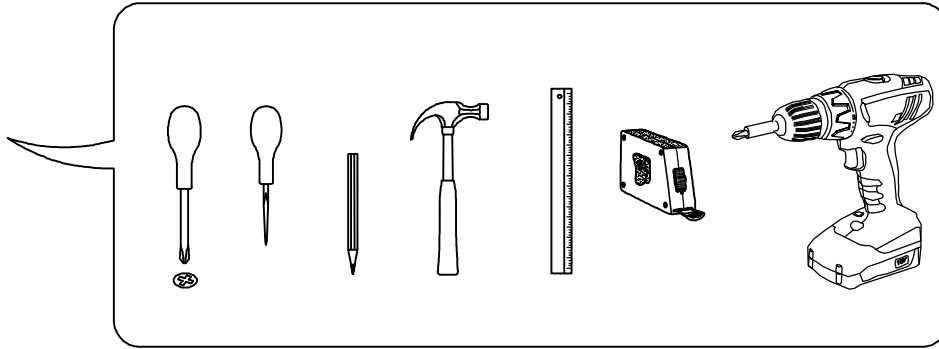

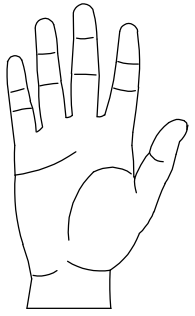

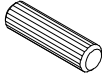

# **В 60 П 1Д (1050)**

## **ГРАФИТИ (GRAFFITI)**

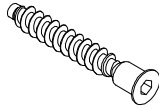
### **U 60 S 1D (1050)**

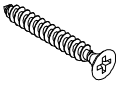
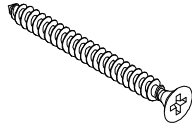

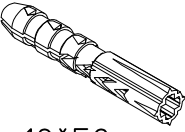
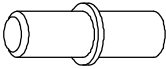
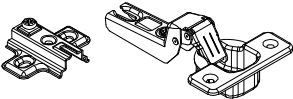
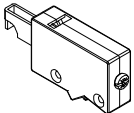
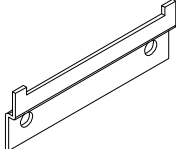
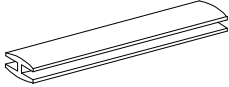
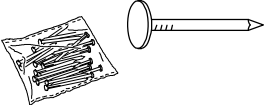
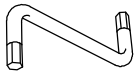

 <b>A1</b> 8*30mm x24	 <b>B</b> $\phi$ 12mm x24	 <b>B1</b> 6,3*50mm x24
 <b>E12</b> 4*16mm x4	 <b>E15</b> 4*30mm x8	 <b>E25</b> 6*60mm x4
 <b>F4</b> 6,3*13mm x4	 <b>H6</b> 10*50mm x4	 <b>J1</b> 5*16mm x8
 <b>L3</b> x2	 <b>N1</b> x2	 <b>O4</b> x2
 <b>O8</b> L-1006 mm x1	 <b>R3</b> 1.4*25mm 0.020kg	 <b>R4</b> N°4 x1
 <b>U3</b> x2		

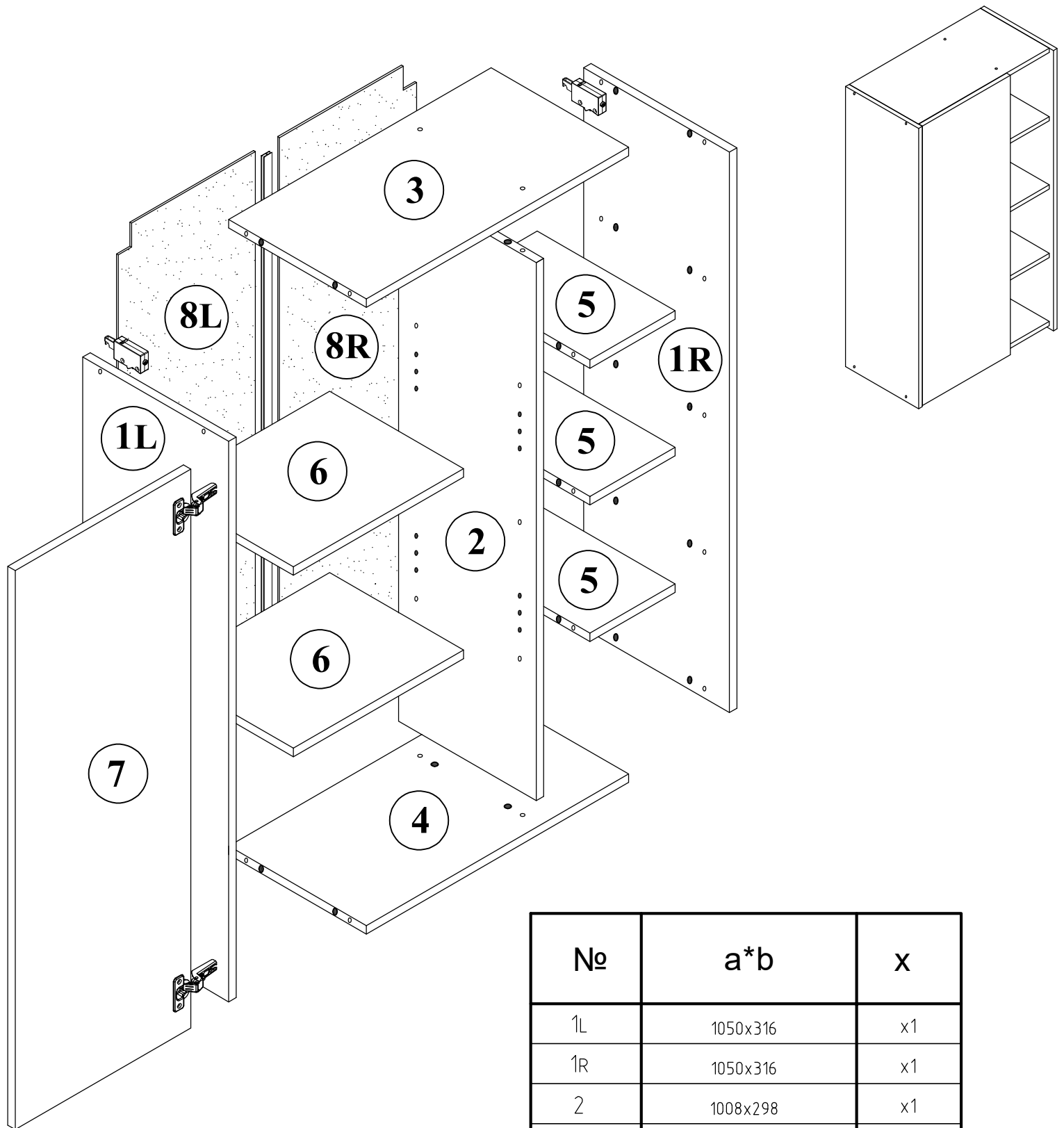

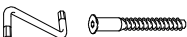
No	a*b	x
1L	1050x316	x1
1R	1050x316	x1
2	1008x298	x1
3	567x298	x1
4	567x298	x1
5	183x298	x3
6	566x290	x2
7	1047x380	x1
8L	1036x297	x1
8R	1036x297	x1
		x1

