

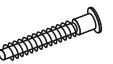

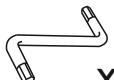







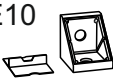

| | | |
|---|---|--|
| B1  $\phi 6,4 \times 50 \text{mm}$ x4 | R  x1 | B  x4 |
| L9  x3 | E10  x2 | A1  $\phi 8 \times 30$ x8 |
| Q  x30 | E8  x1 | E3  $\phi 3.5 \times 16 \text{mm}$ x95 |
| K2  x4 | S7  x1 | R5  L=930mm x1 |

| № | a x b | x |
|---|----------|---|
| 1 | 1034X240 | 1 |
| 2 | 1034X240 | 1 |
| 3 | 556X100 | 2 |
| 4 | 590X240 | 1 |
| 5 | 550X298 | 3 |
| 6 | 520X140 | 6 |
| 7 | 520X80 | 3 |
| 8 | 960x292 | 2 |

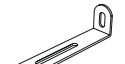
 - L=10mm
 - DVP/ДВП

(ENG) Cabinet for shoes "TO-23"



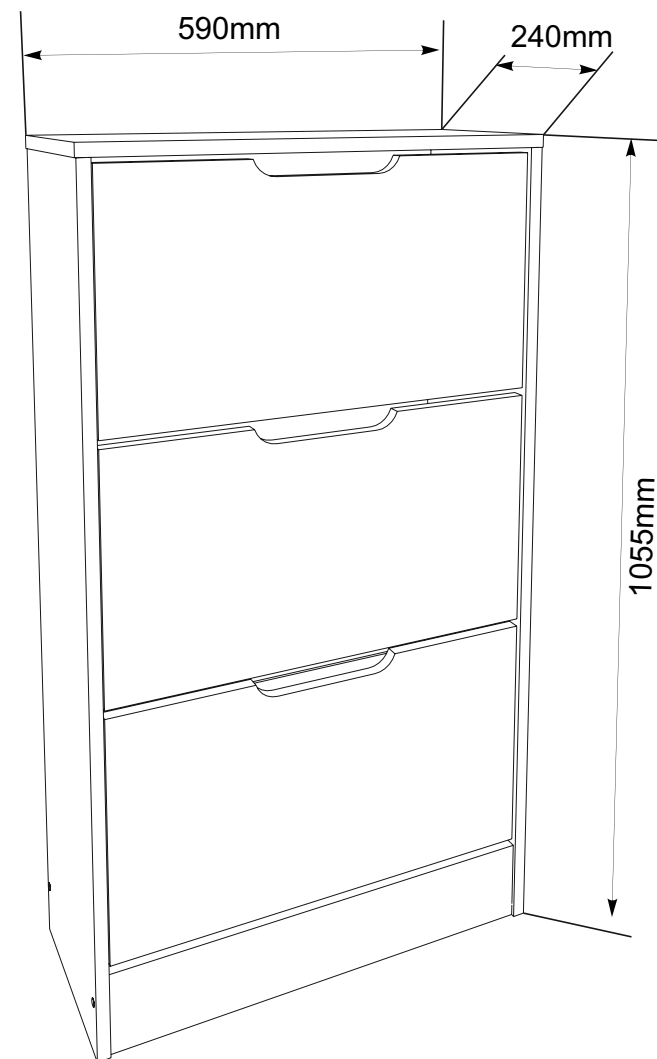

(UA) Тумба під взуття "ТО-23"

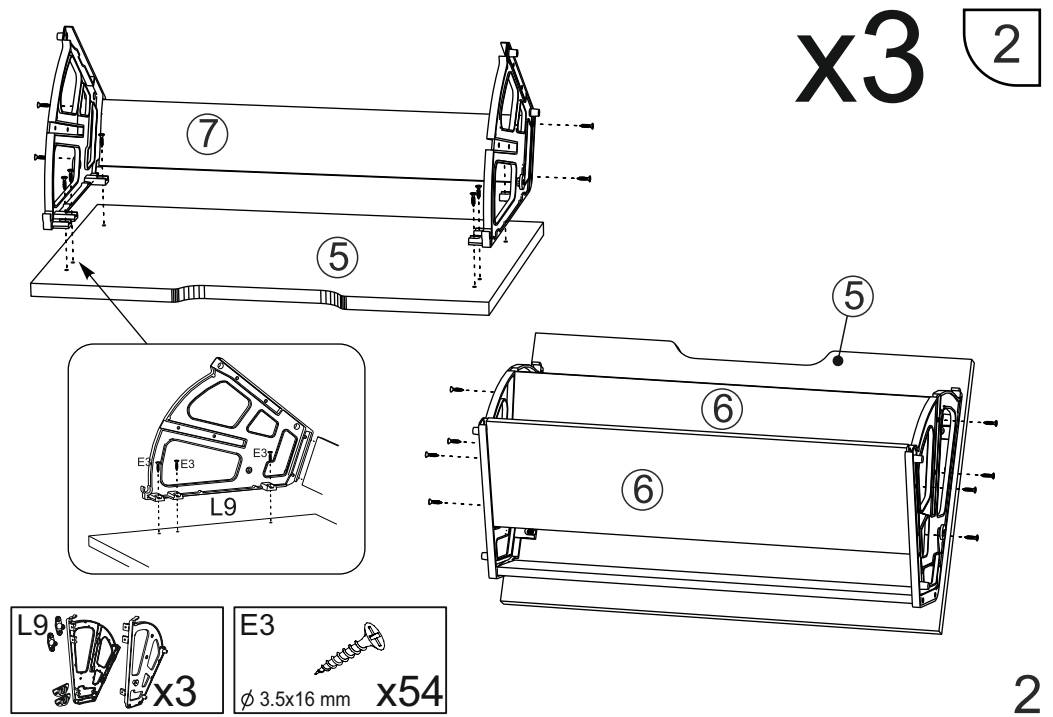
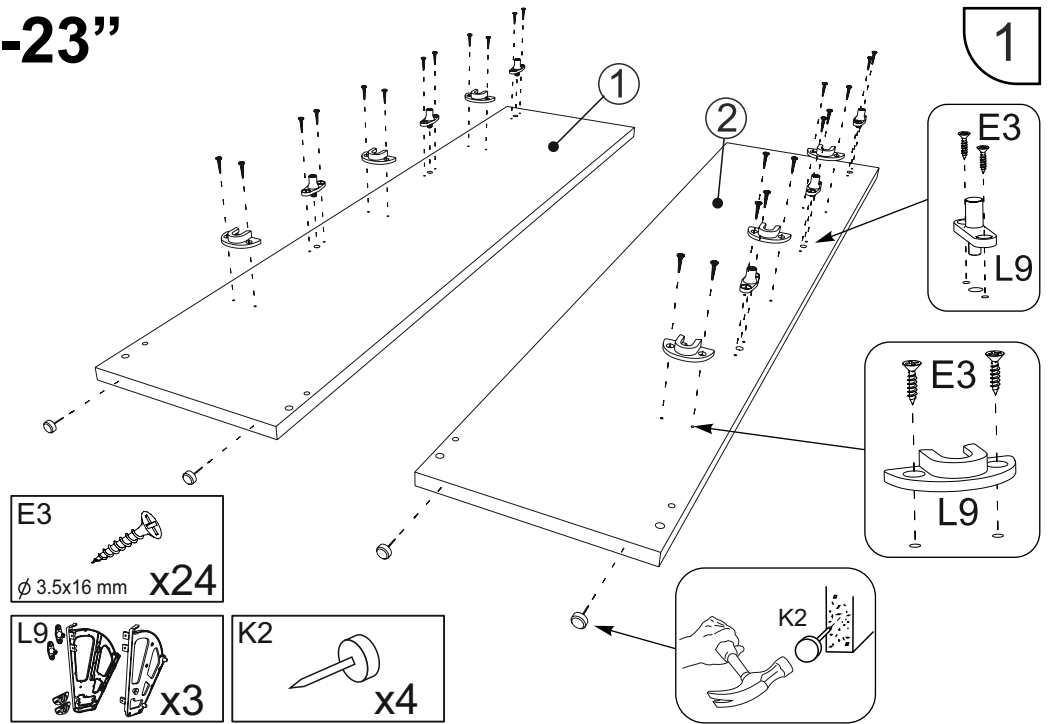
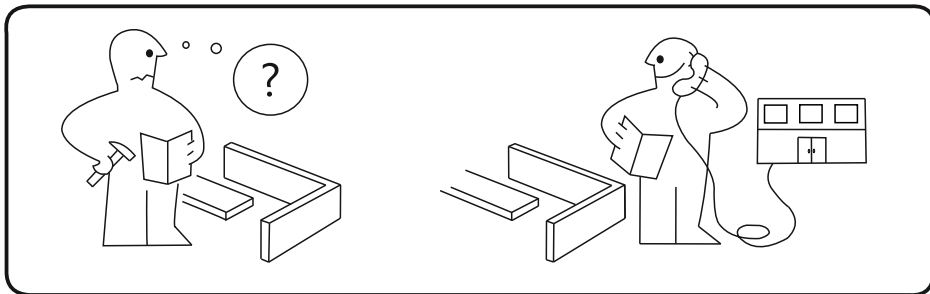
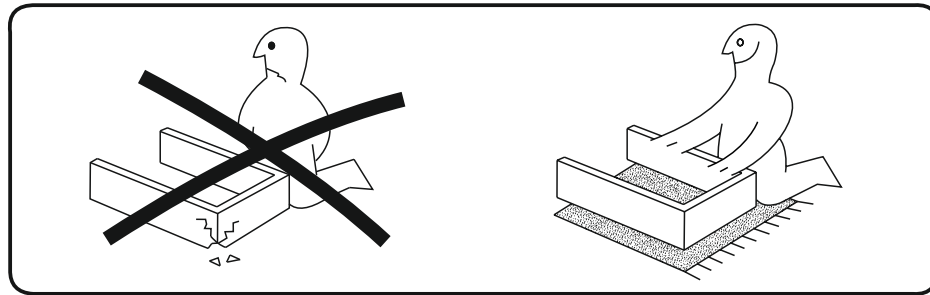
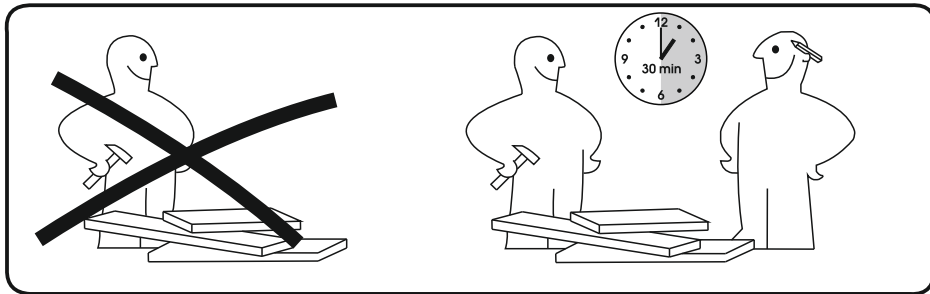

"TO-23"

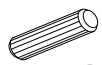

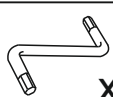

3

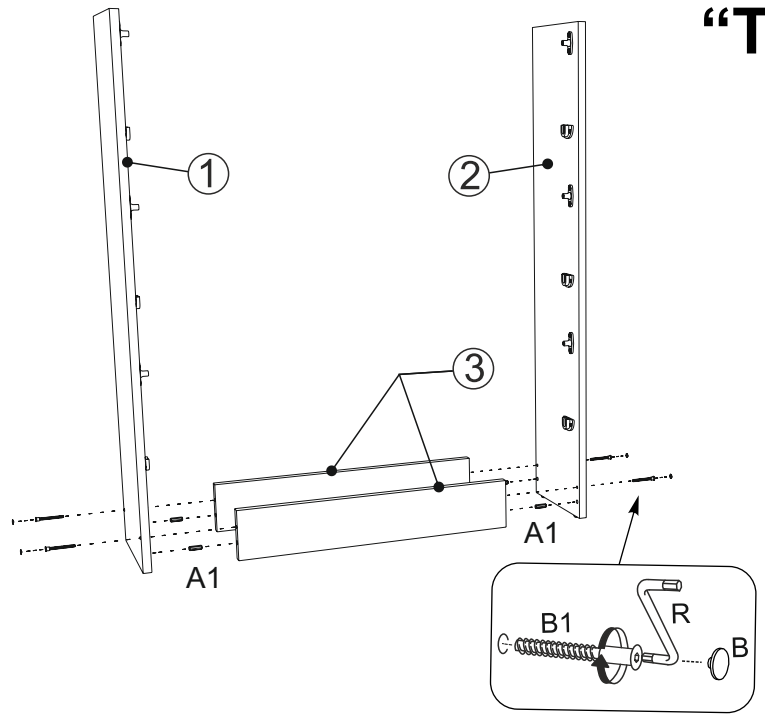
- A1  $\phi 8 \times 30$ x4
- B  x4
- R  x1
- B1  $\phi 6,4 \times 50 \text{mm}$ x4





"TO-23"

5

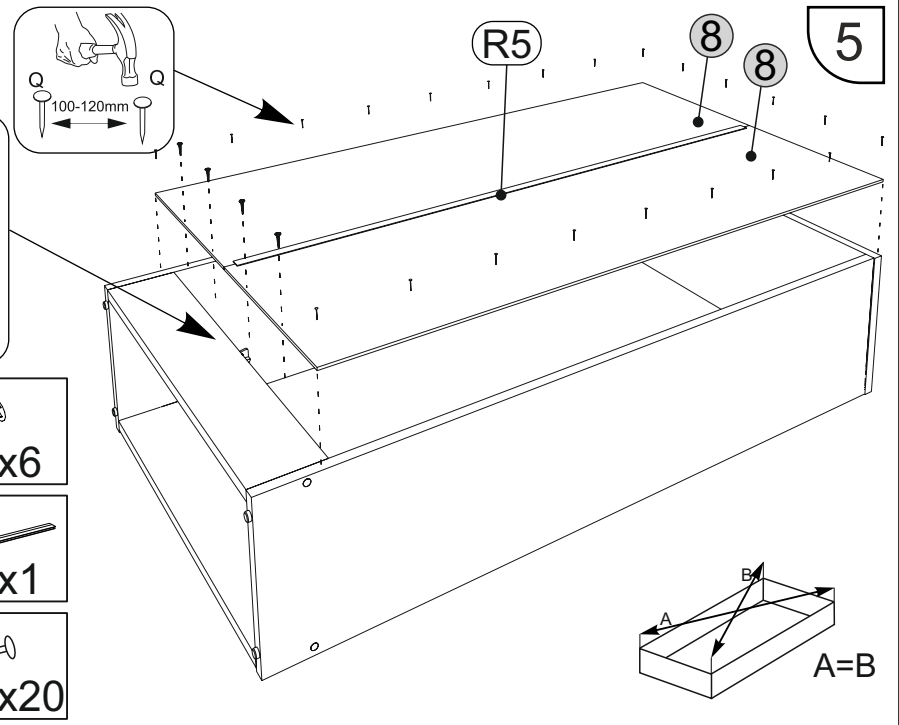
- E3  $\phi 3.5 \times 16 \text{mm}$ x6
- R5  L=930mm x1
- Q  x20



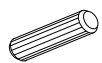

4

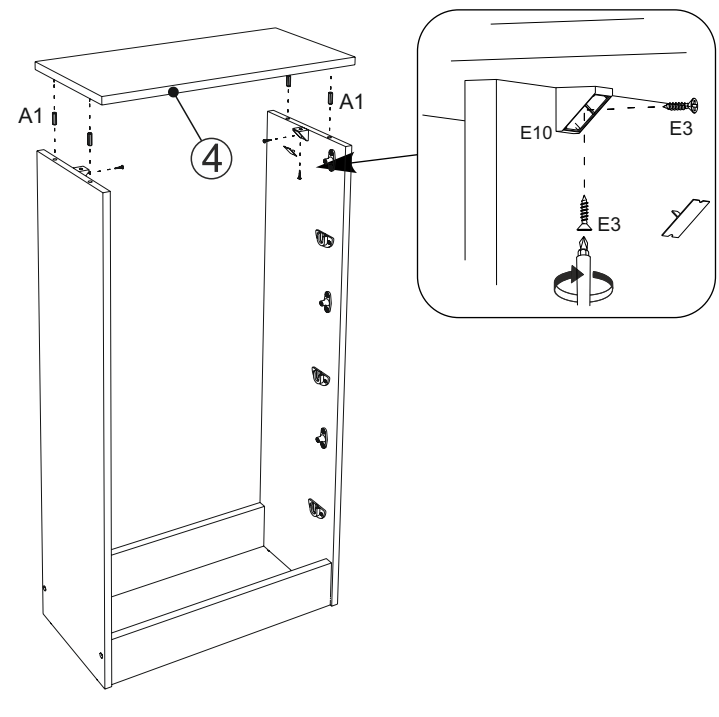
- A1  $\phi 8 \times 30$ x4
- E3  $\phi 3.5 \times 16 \text{mm}$ x4
- E10  x2

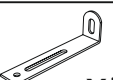

6

- E3  $\phi 3.5 \times 16 \text{mm}$ x3
- E8  x1
- S7  x1

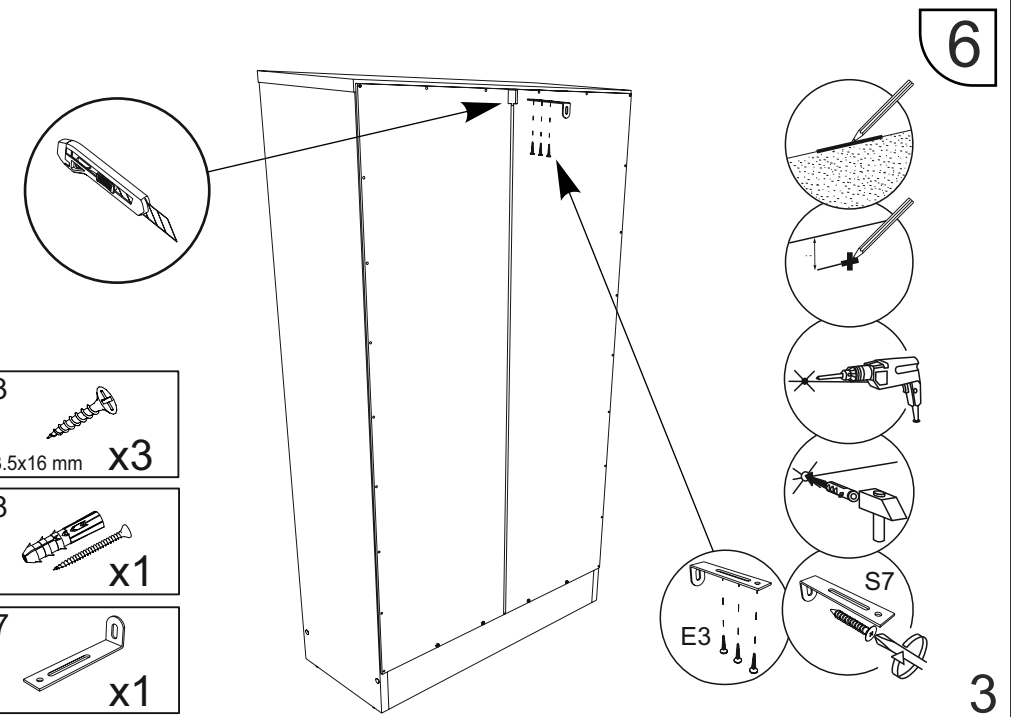

“TO-23”

