















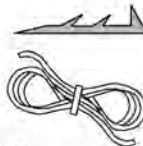
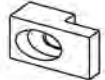

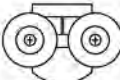







 <p>A-1</p>	 <p>A-2</p>	 <p>A-3</p>	 <p>A-4</p>	 <p>A-5</p>	 <p>A-6</p>	 <p>A-7</p>	
 <p>A-8</p>	 <p>A-9</p>	 <p>A-10</p>	 <p>A-11</p>	 <p>A-12</p>	 <p>A-13</p>	 <p>A-14</p>	
 <p>A-15</p>		 <p>M4*25=8</p>	 <p>M4*40=8</p>	 <p>M4*10=2</p>	 <p>M4*10=2</p>	 <p>M4*10=2</p>	
							



1

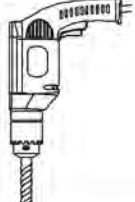

2

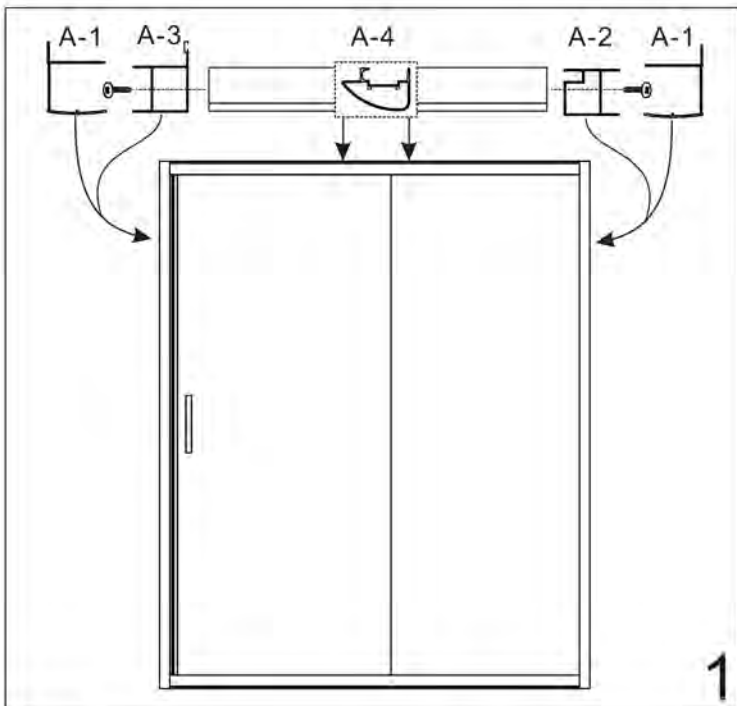
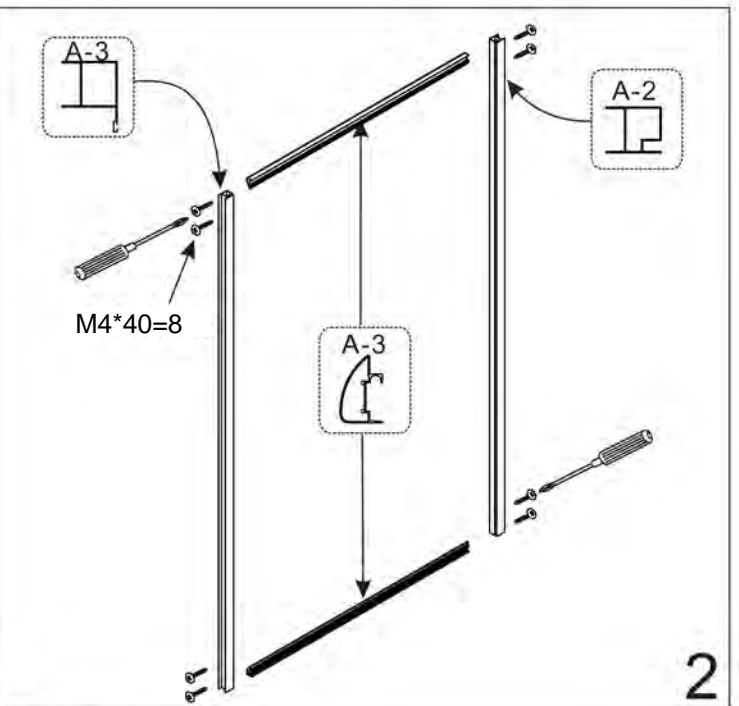
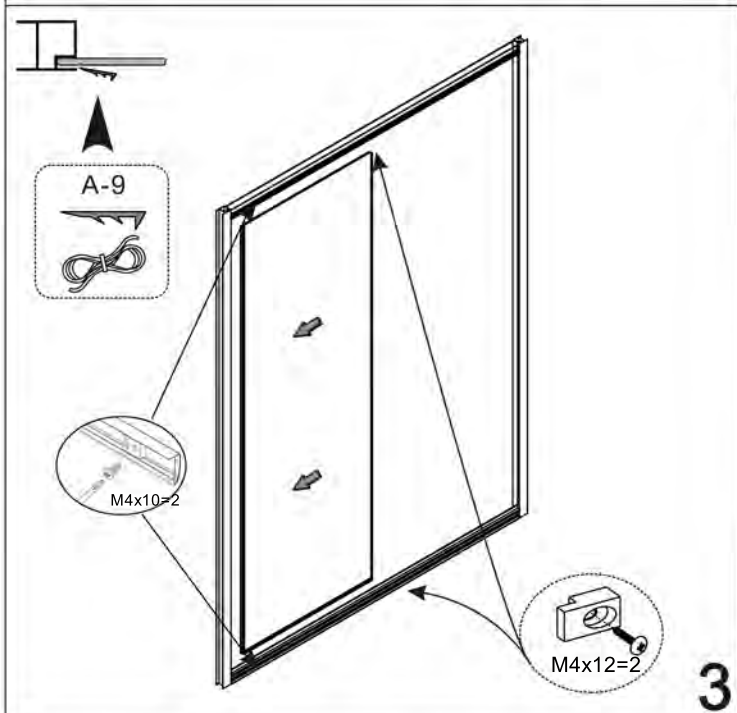

3

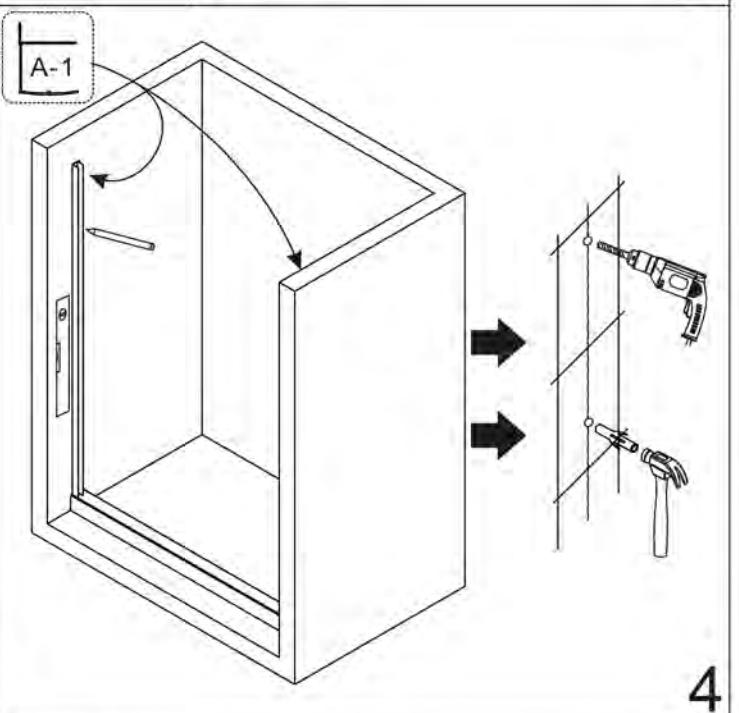

4

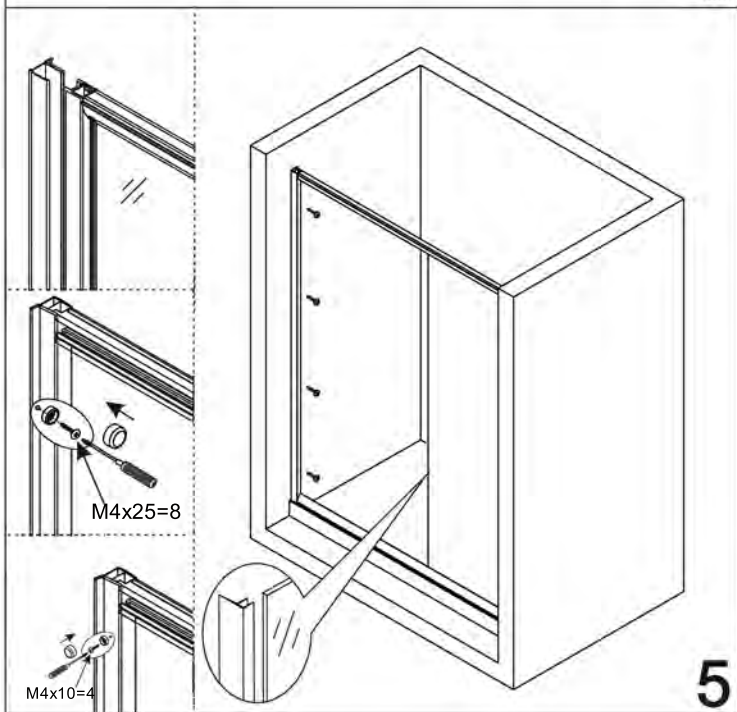

5

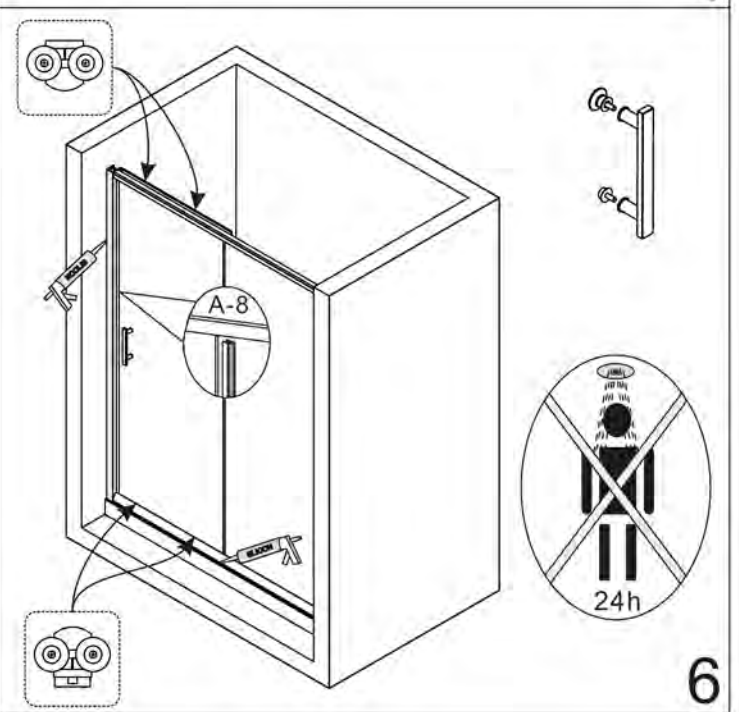

6