

Indoor Unit

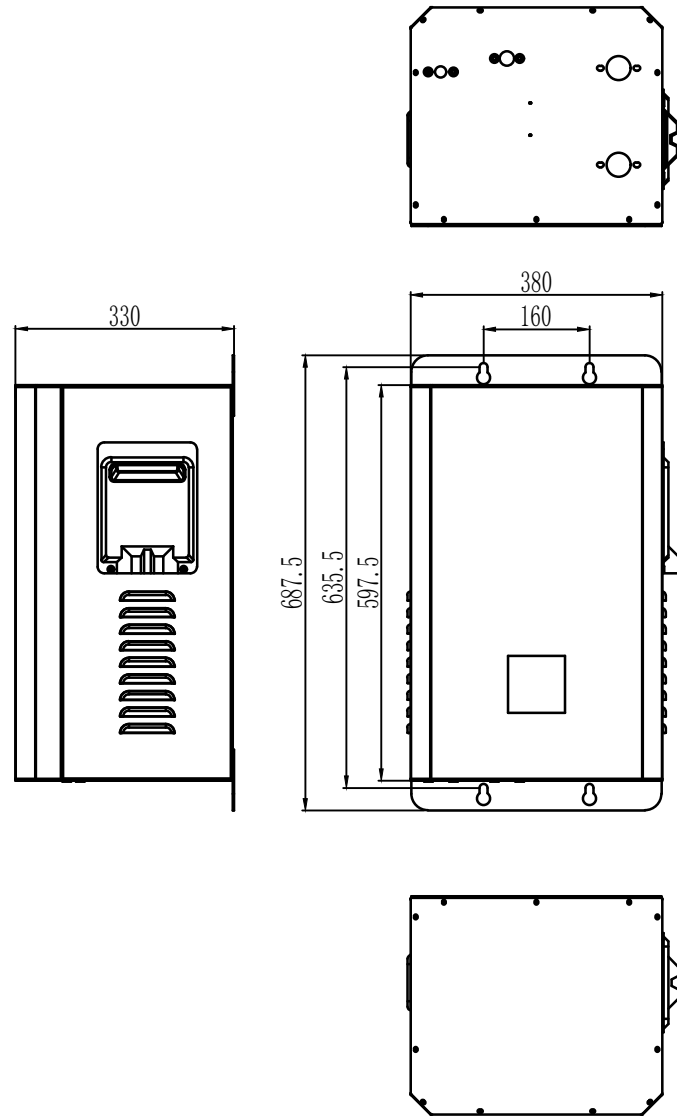

Outdoor Unit

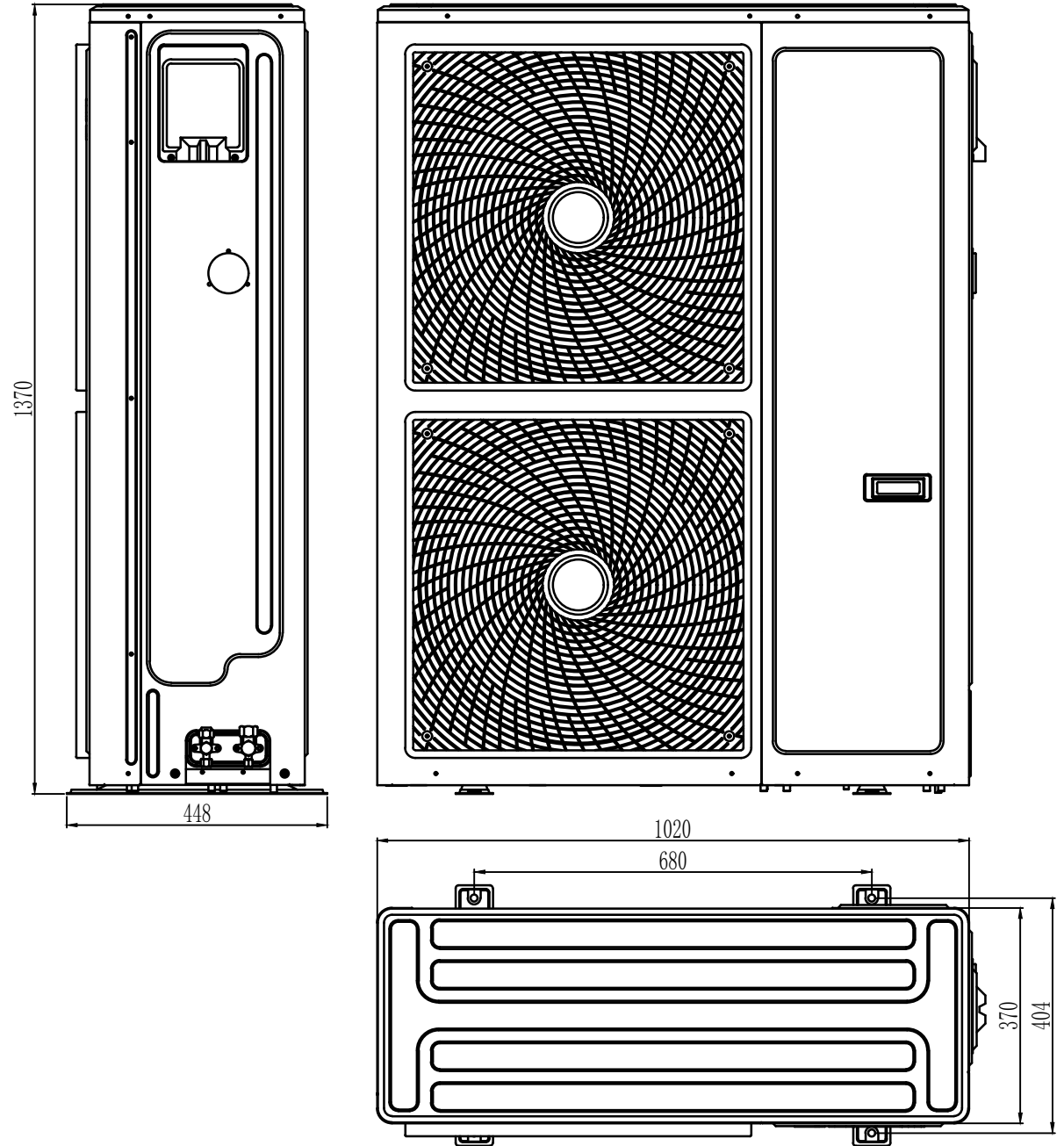

18kW