



Комплектуючі систем ЧПУ

 <http://cnc.prom.ua/>

 +380 (096)-665-71-06
+380 (098)-821-25-90

 cncprom@ukr.net

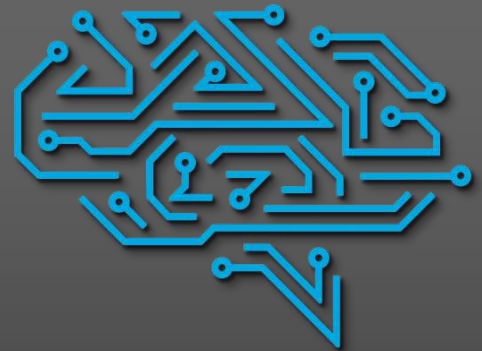

C N C P R O M

Інвертор HY07D543B, 7.5KW 19A 380V



Зовнішній вигляд





1. Introduction

Thank you for purchasing and using the general-purpose inverter of HY series of multi-functions and high performance.

Please read carefully the operation manual before putting the inverter to use so as to correctly install and operate the inverter, give full play to its functions and ensure the safety. Please keep the operation manual handy for future reference, maintenance, inspection and repair.

Due to the inverter of a kind of electrical and electronic product it must be installed, tested and adjusted with parameters by specialized engineering persons of motors.

The marks of **Danger** / **Caution** and other symbols in the manual remind you of the safety and prevention cautions during the handling, installation, running and inspection. Please follow these instructions to make sure the safe use of the inverter. In case of any doubt please contact our local agent for consultation. Our professional persons are willing and ready to serve you.

The manual is subject to change without notice.

Danger indicates wrong use may kill or injure people.

Caution indicates wrong use may damage the inverter or mechanical system.



- Be sure to turn off the input power supply before wiring.
- Do not touch any internal electrical circuit or component when the charging lamp is still on after the AC power supply is disconnected, which means the inverter still has high voltage inside and it is very dangerous.
- Do not check components and signals on the circuit boards during the operation.
- Do not disassemble or modify any internal connecting cord, wiring or component of the inverter by yourself.
- Be sure to make correct ground connection of the earth terminal of the inverter.
- Never remodel it or exchange control boards and components by yourself. It may expose you to an electrical shock or explosion, etc.



- Do not make any voltage-withstanding test with any component inside the inverter. These semiconductor parts are subject to the damage of high voltage.
- Never connect the AC main circuit power supply to the output terminals U,V,W of the inverter.
- The main electric circuit boards of CMOS and IC of the inverter are subject to the effect and damage of static electricity. Don't touch the main circuit boards.
- Installation, testing and maintenance must be performed by qualified professional personnel.
- The inverter should be discarded as industrial waste. It is forbidden to burn it.

1. Checks upon Delivery

The inverter has been strictly and well packed before ex-work. In consideration of various factors during the transportation special attention should be paid to the following points before the assembly and installation. If there is anything abnormal please notify the dealer or the relevant people of our company.

- Check if the inverter has got any damage or deformation during the transportation and handling.
- Check if there is one piece of HY series inverter and one copy of the instruction manual available when unpacking it.
- Check the information on the nameplate to see if the specifications meet your order (Operating voltage and KVA value).
- Check if there is something wrong with the inner parts, wiring and circuit board.
- Check if each terminal is tightly locked and if there is any foreign article inside the inverter.
- Check if the operator buttons are all right.
- Check if the optional components you ordered are contained.

2. Nameplate Description of HY Series Inverter

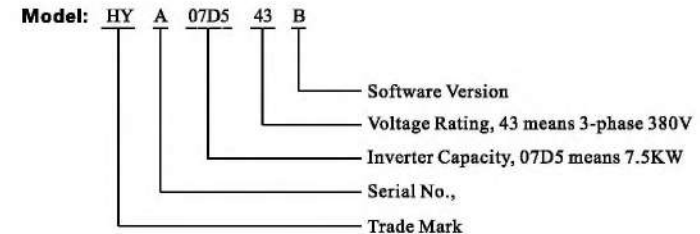



II . Safety Precautions

1. Before the Power-up

Caution

- Check to be sure that the voltage of the main circuit AC power supply matches the input voltage of the inverter.
- The symbol, [E], represents ground terminals. Be sure to make correct ground connection of the earth terminals of the motor and the inverter for safety.
- No contactor should be installed between the power supply and the inverter to be used for starting or stopping of the inverter. Otherwise it will affect the service life of the inverter.

Danger

- R.S.T terminals are power input terminals, never mixed with U,V,W terminals. Be sure that the wiring of the main circuit is correct. Otherwise it will cause damages of the inverter when the power is applied To it.

Caution

- Do not carry the front cover of the inverter directly when handling. It should be handled with the base to prevent the fall-off of the front cover and avoid the dropping of the inverter, which may possibly cause the injuries to people and the damages to the inverter.
- Mount the inverter on a metal or other noncombustible material to avoid the risk of fire.
- Install the inverter in a safe location, avoiding high temperature, direct sunlight, humid air or water.
- Keep the inverter from the reach of children or persons not concerned.
- The inverter can only be used at the places accredited by our company. Any unauthorized working environment may have the risks of fire, gas explosion, electric shock and other incidents.
- Install a heat sink or other cooling device when installing more than one inverter in the same enclosure so that the temperature inside the enclosure be kept below 40°C to avoid overheat or the risk of fire.
- Be sure to turn off the power supply before disassembling or assembling the operation keypad and fixing the front cover to avoid bad contact causing faults or non-display of the operator.

- Do not install the inverter in a space with explosive gas to avoid the risk of explosion.
- If the inverter is used at or above 1000m above seal level, the cooling efficiency will be worse, so please run it by de-rating.
- Do not install any contactor and other components of capacitor or varistor on the output side of the inverter. Otherwise it will cause malfunctions and damages of components of the inverter. Do not install any switch component like air circuit breaker or contactor at the output of the inverter. If any of such components must be installed because of the requirements of process and others, it must be ensured that the inverter has no output when the switch acts. In addition, it is forbidden to install any capacitor for improvement of power factor or any varistor against thunder at the output. Otherwise it will cause malfunctions, tripping protection and damages of components of the inverter. Please remove them as shown in the below diagram.
- It will affect the service life of the inverter if a contact is connected to the front end of input of the inverter to control its starts and stops. Generally it is required to control it through FOR or REV terminals. Special attention should be paid to its use in the case of frequent starts and stops.
- Please use an independent power supply for the inverter. Do avoid using the common power supply with an electrical welder and other equipment with strong disturbance. Otherwise it will cause the protection or even damage of the inverter.

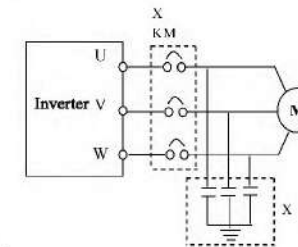

2. During the Power-up

Danger

- Do not plug the connectors of the inverter during the power up to avoid any surge into the main control board due to plugging, which might cause the damage of the inverter.
- Always have the protective cover in place before the power up to avoid electrical shock injury.

3. During the Operation

Danger

- Never connect or disconnect the motor set while the inverter is in running. Otherwise it will cause over-current trip and even burn up the main circuit of the inverter.

Danger

- Never remove the front cover of the inverter while the inverter is powered up to avoid any injury of electric shock.
- Do not come close to the machine when the fault restart function is used to avoid anything unexpected. The motor may automatically restart after its stop.
- The function of STOP Switch is only valid after setting, which is different with the use of emergent stop switch. Please pay attention to it when using it.



Caution

- Do not touch the heat sink, braking resistor, or other heat elements to avoid being scald.
- Be sure that the motor and machine is within the applicable speed ranges before starting operation because the inverter is quite easy to run from lower speed to higher speed.
- Do not check the signals on circuit boards while the inverter is running to avoid danger.
- Be careful when changing the inverter settings. The inverter has been adjusted and set before ex-work. Do not adjust it wantonly. Please make proper adjustments according to the required functions.
- Do consider the vibration, noise and the speed limit of the motor bearings and the mechanical devices when the inverter is running at or above the frequency of 50Hz.

III . Standards and Specifications

1. Particular Specifications

Type	Input Voltage	Power (KW)	Inverter Capacity (KVA)	Output Current (A)	Suitable Motor (KW)
HY00D423B	Single & Three Phase 220V 50Hz	0.4	1.0	2.5	0.4
HY0D7523B	Single & Three Phase 220V 50Hz	0.75	2.0	5.0	0.75
HY01D523B	Single & Three Phase 220V 50Hz	1.5	2.8	7.0	1.5
HY02D223B	Single & Three Phase 220V 50Hz	2.2	4.0	10	2.2
HY0D7543B	3Φ 380V 50Hz	0.75	2.2	2.7	0.75
HY01D543B	3Φ 380V 50Hz	1.5	3.2	4.0	1.5
HY02D243B	3Φ 380V 50Hz	2.2	4.0	5.0	2.2
HY03D743B	3Φ 380V 50Hz	3.7	6.8	8.5	3.7
HY05D543B	3Φ 380V 50Hz	5.5	10	12.5	5.5
HY07D543B	3Φ 380V 50Hz	7.5	14	17.5	7.5
HY001143B	3Φ 380V 50Hz	11	19	24	11
HY001543B	3Φ 380V 50Hz	15	26	33	15
HY18D543B	3Φ 380V 50Hz	18.5	32	40	18.5
HY22D243B	3Φ 380V 50Hz	22	37	47	22
HY30D043B	3Φ 380V 50Hz	30	52	65	30
HY37D043B	3Φ 380V 50Hz	37	64	80	37
HY45D043B	3Φ 380V 50Hz	45	72	91	45
HY55D043B	3Φ 380V 50Hz	55	84	110	55
HY75D043B	3Φ 380V 50Hz	75	116	152	75

HY90D043B	3Φ380V 50Hz	90	134	176	90
HY110D43B	3Φ380V 50Hz	110	160	210	110
HY132D43B	3Φ380V 50Hz	132	193	253	132
HY160D43B	3Φ380V 50Hz	160	230	304	160
HY200D43B	3Φ380V 50Hz	200	290	380	200
HY220D43B	3Φ380V 50Hz	220	325	426	220
HY250D43B	3Φ380V 50Hz	250	381	500	250
HY280D43B	3Φ380V 50Hz	280	427	560	280
HY315D43B	3Φ380V 50Hz	315	460	605	315

Mini Specifications

Type	Input Voltage	Power (KW)	Inverter Capacity (KVA)	Output Current (A)	Suitable Motor (KW)
HY-M0D4A	Single Phase 220V 50Hz	0.4	1.0	2.5	0.4
HY-M0D75A	Single Phase 220V 50Hz	0.75	2.0	5.0	0.75
HY-M1D5A	Single Phase 220V 50Hz	1.5	2.8	7.0	1.5
HY-M0D4B	Three Phase 380V 50Hz	0.4	1.0	1.5	0.4
HY-M0D75B	Three Phase 380V 50Hz	0.75	2.2	2.7	0.75
HY-M1D5B	Three Phase 380V 50Hz	1.5	3.2	4.0	1.5

2. General Specifications

Inverter Series	HY-□□	
Control Mode	SPWM	
Input Power	330~440Vfor 380V power; 170~250for 220V power; 50Hz/60Hz	
5-Digits Display & Status Indicator Lamp	Displaying frequency, current, revolution, voltage, counter, temperature, forward or reserve running, and fault, etc.	
Communication Control	RS-485	
Operation Temperature	-10~40℃	
Humidity	0~95% Relative Humidity (without dew)	
Vibration	Below 0.5G	
Frequency Control	Range	0.10~400.00Hz
	Accuracy	Digital: 0.01% (-10~40℃) , Analog: 0.1% (25±10℃)
	Setting Resolution	Digital: 0.01Hz, Analog: 1% of Max. Operating Frequency
	Output Resolution	0.01Hz
	Operator Setting Method	Press directly →[▲][V] to set
	Analog Setting Method	External Voltage 0~5V, 0~10V, 4~20mA, 0~20mA.
Other Functions	Frequency lower limit, starting frequency, stopping frequency, three skip frequencies can be respectively set.	



General Control	Ramp Control	Selectable 4-speed steps ramp-up and -down time (0.1-6500s).
	V/F Curve	Set V/F curve at will
	Torque Control	Torque increase is settable by max. 10.0%. The starting torque can reach 150% at 1.0Hz.
	Multi-Inputs	6 multi-function input terminals for 8-speed steps control, program operation, switching of 4-speed Ramp, UP-, DOWN function, counter, external emergency stop and other functions.
	Multi-Outputs	5 multi-function output terminals for displaying of running, zero speed, counter, external abnormality, program operation and other information and warnings.
	Other Functions	AVR (auto voltage regulation), Deceleration stop or free-stop, DC brake, auto reset and restart, frequency track, PLC control, traverse function, drawing control, auto energy-savings, carrier adjustable by max. 20KHz, etc.
Protection Functions	Overload Protection	Electronic relay protection motor Drive (for constant torque 150%/1 min. For the kinds of fan 120%/1min.)
	FUSE Protection	FUSE broken, Motor stops.
	Over-voltage	DC Voltage > 400V for 220V class DC Voltage > 800V for 380V class
	Low Voltage	DC Voltage < 200V for 220V class DC Voltage < 400V for 380V class
	Instant Stop and Restart	Restarted by frequency track after instantaneous stop.
	Stall Prevention	Anti-stall during Acc/Dec run
	Output End Shorts	Electronic circuit protecting
Other Functions	Fin over-heat protection, restriction of reverse running, direct start after power on, fault reset, parameter lock PID, one-drive-more, etc.	

IV. Storage and Installation

1. Storage

The inverter must be kept in its original package box before installation. Pay attention to the followings when keeping it in storage if the inverter is not used for the time being:

- It must be stored in a dry place without rubbish or dust.
- The suitable temperature for storage is between -20°C and +65°C.
- The relative humidity required is 0-95% without condensation.
- There is no corrosive gas or liquid in the storage ambience.
- It's better to lay the inverter on a rack and keep it in a proper package.

- It is better not to store the inverter for long time. Long time storage of the inverter will lead to the deterioration of electrolytic capacity. If it needs to be stored for a long time make sure to power it up one time within a year and the power-up time should be at least above five hours. When powered up the voltage must be increased slowly with a voltage regulator to the rated voltage value.

2. Installation Site and Environment

The inverter should be installed at the following location:

- Ambient temperature -5°C to 40°C with good ventilation.
- No water drop and low moisture.
- Free from direct sunshine, high temperature and heavy dust fall.
- Free from corrosive gas or liquid.
- Less dust, oil gas and metallic particles
- Free from vibration and easy for service and inspection.
- Free from the interference of electromagnetic noise.

Attention: The ambient conditions of the inverter will affect its service life.

3. Installation and Direction

- There must be enough space left around the inverter for easy maintenance and cooling. See Diagram .
- The inverter must be installed vertically with the smooth ventilation for effective cooling.
- If there is any instability when installing the inverter, please put a flat board under the inverter bottom base and install it again. If the inverter is installed on a loose surface, stress may cause damage of parts in the main circuit so as to damage the inverter.
- The inverter should be installed on non-combustible materials, such as iron plate.
- If several inverters are installed, upper and lower, together in one cabinet, please add heat dissipation plates and leave enough space between the inverters. See Diagram.

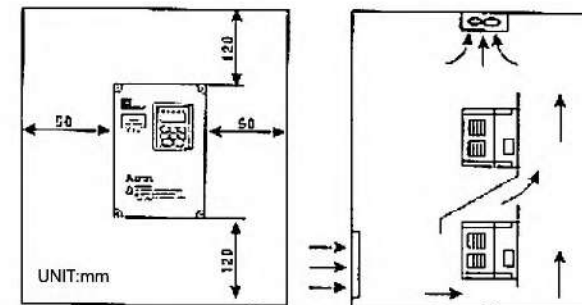



V. Wiring

1. Main Circuit Wiring Schematic Diagram



Power supply: Verify that the inverter's rated voltage coincides with the power supply voltage to avoid a damage of the inverter.



No fuse breaker: Refer to the related list.
Ground fault circuit interrupter: Use one of anti-high harmonic.



Electromagnetic contactor:
Note: Do not use the electromagnetic contactor as the on/off button of power supply for the inverter.



AC reactor: It is recommended to install an AC reactor for power factor improvement if the input capacity is more than 1000KVA.



Inverter:

- Be sure to make correct connections of the main circuit wires and control signal wires of the inverter.
- Be sure to make correct setting of parameters for the inverter.



2. Description of Terminal Block

1) Arrangement of Main circuit Terminals

HY0D4043B~HY02D243B HY0D4023B~HY03D4023B

R	S	T	P	Pr	U	V	W	E

HY04D043B~HY05D043B HY04D023B

E	R	S	T	P	Pr	U	V	W

HY11D043B~HY30D043B

R	S	T			E		U	V	W

Mini Specifications: HY-M□A HY-M□B

The power source is put into through the R.S.T terminals and put out of the U.V.W terminals. The 220v can connect willfully two phase of R.S.T.

(2) Arrangement of Control Circuit Terminals

UPF	DRV	DCM	SPL	SPM	SPH	RST	REV	FOR	ACM	VO	10V	J1			
	FA	FC	FB	+24V	DCM	—	+5V	ACM	AI	VI	RS+	RS-	1	2	3

Notes: Please short circuit the 2-3 foot of J1 terminal when using the board potentiometer .

Like chart:

Please short circuit the 2-3 foot of J1 terminal when using the external connection potentiometer or the external power supply.

Like chart:

Mini inverter terminals

MB	MA	MA	DRV	COM	SPL	SPM	SPH	RST	REV	FOR	RS+	RS-	AI	GND	VO	+5V
----	----	----	-----	-----	-----	-----	-----	-----	-----	-----	-----	-----	----	-----	----	-----

Note: AI is the exterior analogic voltage or current input end, joint the parameter menu of Pd070.

3) Function Description of Main circuit Terminals

Symbol	Function Description
R.S.T	Input terminal of AC line power. (220V class, for both single/three phase, single phase connected to any two phases)
U.V.W	Output terminal of the inverter
P.Pr	Connector for braking resistor.
P1P	Connector for DC reactor (When using a DC reactor the jumper shall be removed.
E	Ground terminal: the third method of grounding for 220V and special grounding for 380 V of Electrical Engineering Regulations.



4) Function Description of Control Circuit Terminals

Symbol	Function Description	Factory setting
FOR	Multi-Input 1	Forward run
REV	Multi-Input 2	Reverse run
RST	Multi-Input 3	Reset
SPH	Multi-Input 4	High speed
SPM	Multi-Input 5	Middle Speed
SPL	Multi-Input 6	Low Speed
DCM (COM)	Common Terminal of Digital and Control Signals	
+10	Power Supply for Speed Setting	+10V
VI	Analog Voltage Frequency Reference Input	0~+10V corresponding to the highest operating frequency
AI	Analog Current Frequency Reference Input	4~20mA corresponding to the highest operating frequency
ACM (GND)	Common Terminal of Analog and Control Signals	
DRV	Multi-Output 1 (Optical couple output)	DC24V/100mA
UPF	Multi-Output 2 (Optical couple output)	
FA(MB) FB(MA) FC(MA)	Multi-Output 3 (N/O or N/C)	3A/250V
VO	Output terminals of digital frequency	0~10V
RS+ RS-	RS485 Communication port	

3. Basic Connection Diagram

The wiring of the inverter is divided into two parts, main circuit terminal connections and control circuit terminal connections. The user can see the main circuit terminals, and the control circuit terminals after removing the cover of enclosure. The terminals must be connected correctly as the following wiring circuit diagrams.

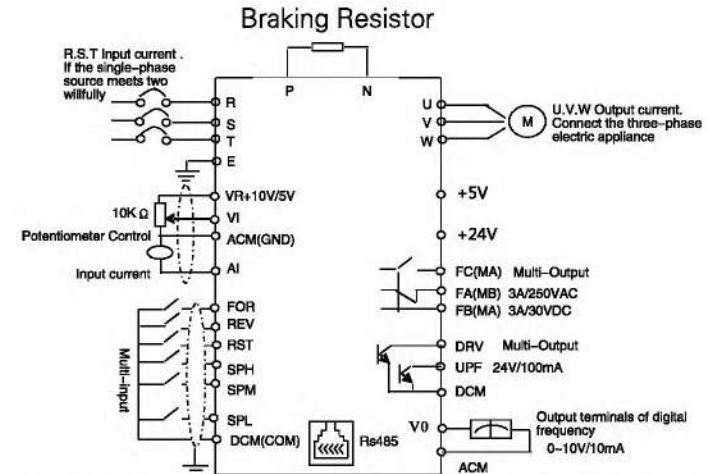

Note: The above wiring diagram explained that only supplies the reference, take the actual product as the standard. The diagram is subject to change without notice.

4. Precautions on Wiring

1) For the main circuit wiring:

- While wiring the sizes and specifications of wires should be selected and the wiring should be executed according to the electrical engineering regulations to ensure the safety.
- It is better to use shielded wire or wire and conduit for power cord and ground the shielded layer or two ends of wire conduit.
- Be sure to install a Non Fuse Breaker (NFB) between the power supply and the input terminals (R.S.T). (If using ground fault circuit interrupter, please choose one corresponding to high frequency)
- Never connect AC power to the output terminal (U.V.W) of the inverter.
- Output wires mustn't be in touch of the metal part of the inverter enclosure, or it will result in earth short-circuit.
- Phase-shifting capacitors, LC, RC noise filters, etc. can never be connected to the output terminals of the inverter.
- The main circuit wire must be enough far away from other control equipments.
When the wiring between the inverter and the motor exceeds 15 meters for 220V class or 30 meters for 380V class, much higher dV/dT will be produced inside the coil of the motor, which will cause the destruction to the interlay or insulation of the motor. Please use a dedicated AC motor for the inverter or add a reactor at the inverter.



- Please lower the carrier frequency when there is a longer distance between the inverter and the motor. Because the higher the carrier frequency is the bigger the leakage current of high-order harmonics in the cables will be. The leakage current will have unfavorable effect on the inverter and other equipment.

2) For control circuit wiring (signal line)

- The signal line should be separately laid in a different conduit with the main circuit wire to avoid any possible interference.
- Please use the shielded cable with the size of 0.52mm² for signal lines.
- Use the control terminals on the control panel correctly according to your needs.

3) Grounding

- Grounding terminal E. Be sure to make correct grounding
220V class: The third grounding method (Grounding resistance should be 100Ω or lower.)
380V class: The special third grounding method (Grounding resistance should be 10Ω or lower.)
- Choose grounding wires according to the basic length and size of the technical requirements of the electric equipment.
- Do avoid sharing grounding wire with other large power equipment such as electric welder, power machine, etc. The grounding wire should be kept away from the power supply wires for large equipment.
- The grounding method for several inverters together should be done as the first and second diagrams below. Avoid the third loop.
- The grounding wire must be as shorter as possible.

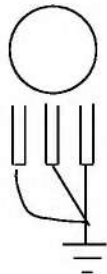

(1) Good

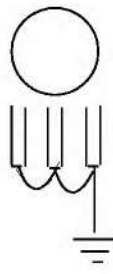

(2) Good

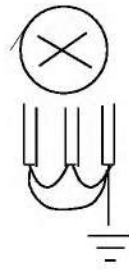

(3) Not good

VI. Instruction of the Digital Operator

1. Description of the Digital Operator

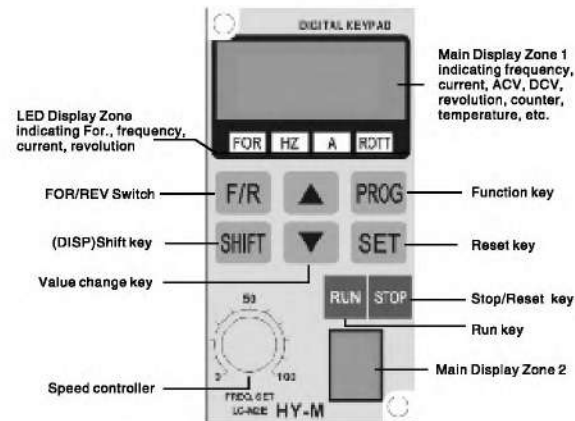
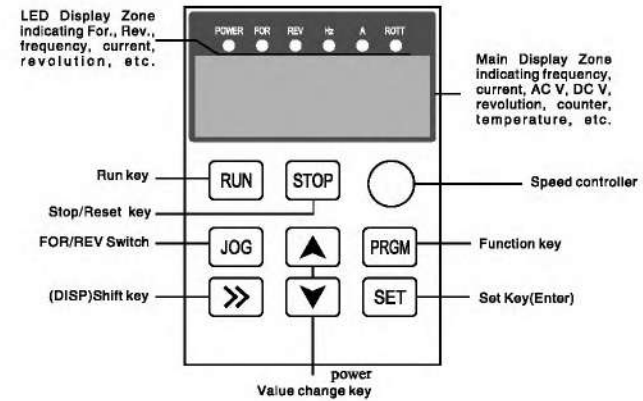

NOTE: The LED main display zone demonstrates by 5 nixietubes, the main display zone 2 demonstrates the 5th digit.

Example: 12345, 1234 digit in the main display zone 1, digit 5 in the main display zone 2.



2. Description of Indicator Lamp Status

1) Description of Indicator Lamp Status

Indicator lamp	Status	Description
FOR	on	The motor is in forward rotation.
REV	on	The motor is in reverse rotation.
HZ	on	Displaying set frequency or output frequency.
A	on	Displaying output current.
ROTT	on	Displaying rated motor revolution
HZ A	on	Displaying DC voltage.
A ROTT	on	Displaying AC voltage.
HZ ROTT	on	Displaying counting value.
HZ A ROTT	on	Displaying internal temperature of the inverter.

2) Description of Display Items

Display	Indic.lamp \square on	Meaning
F50.00	HZ A R/min \square \circ \circ	Present output frequency is 50.00HZ
F50.00	HZ A R/min \square \circ \circ	Present set frequency is 50.00HZ
P003.0	HZ A R/min \circ \circ \square	Present set frequency is 50.00HZ 3.0A
01440	HZ A R/min \circ \circ \square	Present output revolution is 1440r/min
0510.1	HZ A R/min \circ \square \square	Present DC voltage is 510.1V
0380.0	HZ A R/min \circ \square \square	Present AC voltage is 380.0V
0035.0	HZ A R/min \square \square \square	Present inverter's temperature is 35.0°C

00105	HZ A R/min \square \circ \square	Present counter's value is 105
050.0	HZ A R/min \circ \circ \circ	Present target value of PID is 50.0%
048.0	HZ A R/min \circ \circ \circ	Present feedback value of PID is 48.0%
00012	HZ A R/min \square \square \circ	Present time of power-on is 12 hours
00108	HZ A R/min \circ \square \square	Total run time of inverter is 108 hours

3. Description of Operation Examples

Procedures	Display	Indicator Lamp	Explanation
Power up, Operation of power ↓	Dsp2.0 Flash →Vr2.00 →000.00	FOR HZ ϕ \square	Self detect when power-up, display version no. (Flashing) and finally set frequency.
PRGM ↓	Pd000	FOR HZ ϕ \square	Enter programming Display the function of Pd000
ENYER (SET) ↓	000.0 ϕ	FOR HZ ϕ \square	Display the contents of Pd003
\blacktriangle ↓ ← ENYER ↓ PRGM	50.00 END→50.00 Pd00 ϕ 050.0 ϕ	FOR HZ ϕ \square FOR HZ ϕ \square	Change the content of PD003 Confirm changed value. Display END 50.00 Pd004 Back from programming
↓ RUN	F50.00	FOR HZ \square \square	Display running and operating frequency
↓ DISP (→) SHIFT	50.00 F0.00→F50.00	FOR HZ \square \square	Monitor screen switching, display output current
↓ PRGM	F50.00	FOR HZ \square \square	Monitor screen switching, display output current



↓ DISP	01440	FOR A □ □	Monitor screen switching, display revolution
↓ PROG	F 50.00	FOR ROTT □ □	Switch back to main screen, display set frequency
↓ JOG	F 50.00	FOR HZ □ □	Switch of For.Rev. rotation, display the status of Rev rotation
↓ ▲	050.00	FOR HZ □ □	Switch to adjustable frequency
↓ ←▲	000.00	FOR HZ □ □	Adjust set frequency, i.e. the value of Pd003
↓ ENTER	030.00	FOR HZ □ □	Confirm changed value, write to Pd003 as value
↓ STOP	F 30.00	FOR HZ ℄ □	Stop

Note:

- ① ℄ means flashing. □ means bright.
- ② For monitoring AC, DC, T and other items they can be only switched and displayed after the parameter setting.
- ③ When it is powered up again after a power breakdown the inverter will display the screen previous to the power breakdown after its self detection.

VI. Commissioning

1. Important Checks before the Commissioning

If there is any wrong connected wires? Pay special attention to the terminal of U.V.W; Make sure the power supply wires are connected to R.S.T, not U.V.W.

If there is any metal powder or wires left on the base plate of the inverter or the terminal block, which may cause short circuit.

If screws are tightly locked and if the connecting parts are loose.

If there is any short circuit or earth fault at outputs.

2. Commissioning Methods

The procedure of the operator is factory set up for the control mode of HY series. The commissioning can be carried out through the digital operator. Generally, the commissioning can be conducted at 5.00 Hz.

Procedures	Display	Indicator Lamp	Explanation
Power up ↓	disp1.1→Vr2.0 000.00	FOR HZ ℄ □	Self detect when power up, display version no. and finally set frequency
△	000.00	FOR HZ ℄ □	Switch to adjustable frequency on the panel
←↓ △	050.00	FOR HZ ℄ □	Change set frequency, i.e. The value of Pd003
↓ ENTER	F 50.00	FOR HZ ℄ □	Confirm changed value
↓ RUN	F 50.00	FOR HZ □ □	Run at 50Hz
↓ STOP	F 30.00	FOR HZ ℄ □	Stop

Note: □ means indicator lamps is on; ℄ means indicator lamps flash;



VI. Function List

Parameters Function List 1

Category	Code	Function	Set Range & Function Explanation	Factory Setting
Basic Parameters	PD000	Parameter Lock	0: Invalid 1: Valid	0
	PD001	Source of Run Commands	0: Operator 1: External terminal 2: Communication port	0
	PD002	Source of Operating Frequency	0: Operator board 1: Simulation amount set(board potentiometer and external potentiometer) 2: Communication port	0
	PD003	Main Frequency	0.00~400.00 Hz	*
	PD004	Base Frequency	0.01~400.00 Hz	50.00
	PD005	Max Operating Frequency	50.00~400.00 Hz	50.00
	PD006	Intermediate Frequency	0.01~400.00 Hz	2.50/3.0
	PD007	Min. Frequency	0.01~20.00 Hz	0.50
	PD008	Max. Voltage	0.1V----*	220/380
	PD009	Intermediate Voltage	0.1V----*	*
	PD010	Min. Voltage	0.1~50.0V	*
	PD011	Frequency Lower Limit	0.00~400.00 Hz	0
	PD012	Reserved		
	PD013	Parameter Reset	1: Restore the factory setting. No other function.	00
	PD014	Accel. Time 1	0.1~6500.0S	*
	PD015	Decel. Time 1	0.1~6500.0S	*
	PD016	Accel. Time 2	0.1~6500.0S	*
	PD017	Decel. Time 2	0.1~6500.0S	*
	PD018	Accel. Time 3	0.1~6500.0S	*
	PD019	Decel. Time 3	0.1~6500.0S	*
	PD020	Accel. Time 4	0.1~6500.0S	*
	PD021	Decel. Time 4	0.1~6500.0S	*
	PD022	Reserved		
	PD023	Rev. Rotation Select	0: Rev Run forbidden; 1: Rev Run Enable	0
PD024	STOP key select	0: STOP Invalid 1: STOP Valid	1	
Application parameter	PD025	Starting Mode	0: Start from Starting Frequency 1: Frequency track start	0
	PD026	Stopping Mode	0: Decelerating stop 1: Coasting stop	0
	PD027	Starting Frequency	0.1~10.0 Hz	0.5
	PD028	Stopping Frequency	0.1~10.0 Hz	0.5

	PD029	Braking time at start	0~25.0	0.0
	PD030	Braking time at stop	0~25.0	0.0
	PD031	DC Braking level	0.0~20.0%	2.0
	PD032	Frequency track time	0.1~20.0S	5.0
	PD033	Current level for frequency track	0.0~200.0S	150.0
	PD034	Voltage rise time during frequency track	0.1~10S	0.5
	PD035~PD040	Reserved		
	PD041	Carrier frequency	0~15	*
	PD042	Jogging Frequency	0.00~400.00Hz	5.00
	PD043	S-Curve Time	0~6500S	0

Parameters Function List 2

Category	Code	Function	Set Range & Function Explanation	Factory Setting
Terminals of Input/Output	PD044	FOR (D1)	0: Invalid; 1:Run; 2: For rotation; 3: Rev rotation; 4: Stop; 5: FOR/REV.; 6: Jog; 7: Jog For rotation; 8: Jog Rev Rotation; 9:Timer1; 10:Timer2; 11:Reserved; 12: Overheat of heat sink or motor; 13:Emergent stop; 14:Reset; 15~16: Reserved ;17: Ramp select 1;18 :Ramp select2;19: Multi-speed1 ; 20: Multi-speed 2; 21: Multi-speed 3; 22: High speed; 23: Middle speed;24: Low speed; 25: PID Start; 26: Reserved; 27: UP function Counter 28: DOWN function; 29: Drawing;30: Reserved;31: Counter; 32: Counter reset	02
	PD045	REV(D2)		03
	PD046	RST(D3)		04
	PD047	SPH(D4)		07
	PD048	SPL(D5)		19
	PD049	SPM(D6)		20
	PD050	Y1 Output		01
	PD051	Y2 Output		03
	PD052	Terminals of FA,FB,FC		01
				9:Arbitrary Frequency 2 reach;



Input and Output Terminals	Pd053	Terminals of KA,KB	10:Motor Overload alarm; 11:Overtorquealarm; 12:InverterOverloadalarm; 13:Counterreach;14-16: Reserved;17:Low voltage alarm; 18: Single stage end indication;19: Process end indication; 20-26: Reserved; 27: Drawing reach; 28: PIDlower limit alarm; 29: PID upper limitalarm; 30: Reserved; 31:Braking resistor act ;32: Fan act.	03
	PD054	VO Output	Output of digital frequency signals 0-7	0
	PD055	VO Analog output Gain	0.0-100.0%	100
	PD056	Skip Frequency 1	0.00-400.00 Hz	0.00
	PD057	Skip Frequency 2	0.00-400.00	0.00
	PD058	Skip Frequency 3	0.00-400.00	0.00
	PD059	Skip Frequency Range	0.10-10.00	0.50
	PD060	Uniform Frequency 1	0.00-400.00 Hz	0.00
	PD061	Uniform Frequency 2	0.00-400.00 Hz	0.00
	PD062	Uniform Frequency Range	0.10-10.00 Hz	0.50
	PD063	Timer 1 time	0-10.0	0.1
	PD064	Timer 2 time	0-100	1
	PD065	Counting value set	00-65500	00
	PD066	Intermediate Counter	0-65500	0
	PD067-PD069	Reserved		

Parameters Function List 3

Category	Code	Function	Set Range & Function Explanation	Factory Setting
	PD070	Analog Input	0:0-10V 1:0-5V 2:0-20mA 3:4-20mA 4:0-10V,stacked 4-20mA Exterior pulse of input	0
	PD071	Analog Filtering Constant	0-50	20
	PD072	Lower Analog Frequency Higher Analog Frequency	0.00-400.00 Hz 0.00-400.00 Hz	50.00
	PD073			0
	PD074	Bias Direction at Higher Frequency	0: Positive direction 1: Negative direction	0
	PD075	Bias Direction at Lower Frequency	0: Positive direction 1: Negative direction	0
	PD076	Analog Negative Bias Reverse	0: Not allowable. 1: Allowable.	0
	PD077	Up/Down Function	0: Not memorized 1: Memorized	0
	PD078	Up/Down Speed	0: 0.01HZ 1: 0.1HZ	0
	PD079	Reserved		
Category	Code	Function	Set Range & Function Explanation	Factory Setting
Multi-speeds Operation	PD080	PLC Operation	0: Normal run; 1: Internal control 16-speed; 2: External control 4-speed; 3: External control 8-speed 4: Drawing 5: Disturbance;	0
	PD081	Internal Control Multi-speeds Operation	0: Stop after running for one cycle; 1: Cycling run; 2: Auto stop after running for one cycle (STOP for intervention); 3: Auto Run and Cycling (STOP for intervention)	0



Multi-speeds Operation	PD082	PLC Before 8 speeds Running Direction	0-255 (0: For 1: Rev)	0
	PD083	PLC After 8 speeds Running Direction	0-255 (0: For 1: Rev)	0
	PD084	Before 8 speeds PLC Ramp Time	0-65535	0
	PD085	After 8 speeds PLC Ramp Time	0-65535	0
	PD086	Frequency 2	0.00-400.00 Hz	15.00
	PD087	Frequency 3	0.00-400.00 Hz	20.00
	PD088	Frequency 4	0.00-400.00 Hz	25.00
	PD089	Frequency 5	0.00-400.00 Hz	30.00
	PD090	Frequency 6	0.00-400.00 Hz	35.00
	PD091	Frequency 7	0.00-400.00 Hz	40.00
	PD092	Frequency 8	0.00-400.00 Hz	0.50
	PD093	Frequency 9	0.00-400.00 Hz	10.00
	PD094	Frequency 10	0.00-400.00 Hz	15.00
	PD095	Frequency 11	0.00-400.00 Hz	20.00
	PD096	Frequency 12	0.00-400.00 Hz	25.00
	PD097	Frequency 13	0.00-400.00 Hz	30.00
	PD098	Frequency 14	0.00-400.00 Hz	35.00
PD099	Frequency 15	0.00-400.00 Hz	40.00	
PD100	Frequency 16	0.00-400.00 Hz	45.00	
PD101	Timer 1	0.0-6500.0S	10.0	
PD102	Timer 2	0.0-6500.0S	10.0	
PD103	Timer 3	0.0-6500.0S	0.0	
PD104	Timer 4	0.0-6500.0S	0.0	
PD105	Timer 5	0.0-6500.0S	0.0	
PD106	Timer 6	0.0-6500.0S	0.0	
PD107	Timer 7	0.0-6500.0S	0.0	
PD108	Timer 8	0.0-6500.0S	0.0	
PD109	Timer 9*	0.0-6500.0S	0.0	
PD110	Timer 10	0.0-6500.0S	0.0	
PD111	Timer 11	0.0-6500.0S	0.0	
PD112	Timer 12	0.0-6500.0S	0.0	
PD113	Timer 13	0.0-6500.0S	0.0	
PD114	Timer 14	0.0-6500.0S	0.0	
PD115	Timer 15	0.0-6500.0S	0.0	
PD116	Timer 16	0.0-6500.0S	0.0	

Parameters Function List 4

Category	Code	Function	Set Range & Function Explanation	Factory Setting	
	PD117	AutoPLC Memory Function	0-1	0	
	PD118	Over-voltage Stall Prevention	0-1	1	
	PD119	Stall Prevention Level at Accel.	0-200	150	
	PD120	Stall Prevention Level at Constant Speed	0-200	0	
	PD121	The Decel Time of Stall Prevention Level at Constant Speed	0.1-25.5	5	
	PD122	Stall Prevention Level at Decel.	0-200	150	
	PD123	Over-torque Detect Mode	0-3	0	
	PD124	Over-torque Detect Level	0-200	0	
	PD125	Over-torque Detect Time	0.1-20.0	1.0	
	PD126	Pulse Counter Memory	0-1	0	
	PD127- PD129	Reserved			
	Water Supply with Constant Pressure	PD130	Number of Auxiliary Pump	0-2	0
		PD131	Continuous Operating Time of Aux. Pumps	1-9000min	60
		PD132	Interlocking Time of Aux. Pumps	1-250s	5s
PD133		High Speed Running Time	1-250s	60s	
PD134		Low Speed Running Time	1-250s	60s	
PD135		Stopping Voltage Level	1-150%	95%	
PD136		Lasting Time of Stopping Voltage Level	1-250s	30s	
PD137		Wakeup Level	1-150%	80%	
PD138		Sleep Frequency	0.00-400.0	20.00	
PD139		Lasting Time of Sleep Frequency	1-250s	20s	
Motor Function Parameters	PD141	Rated Motor Voltage	Set according to Motor nameplate	*	
	PD142	Rated Motor Current	Set according to Motor nameplate	*	
	PD143	Motor pole number.	0210	04	
	PD144	Rated Motor Revolution	24000	1440	



	PD145	Auto Torque Compensation	2.0-10.0	2.0
	PD146	Motor no-load current	0100	40
	PD147	Motor slip compensation	0.0-100	20
	PD148- PD149	Reserved		
	PD150	Auto Voltage Regulation	0-1	1
	PD151	Auto Energy Saving	0-20	0
	PD152	Fault Restart Time	0.2-25	1
	PD153	Restart after Instantaneous Stop	0: Invalid 1: Frequency track	0
	PD154	Allowable Power-Breakdown Time	0.1-5.0S	0.5
	PD155	Number of Abnormal Restart	0-10	00

Parameters Function List 5

Category	Code	Function	Set Range & Function Explanation	Factory Setting
PID Parameters	PD156	Proportional Constant (P)	0.0-1000.00%	100%
	PD157	Integral Time (I)	0.1-3600.00S	5.0
	PD158	Differential Time (D)	0.01-10.00S	0
	Pd159	Target value	0.0-100.0%	0
	Pd160	Target value select	0: set by the operator 1: set by external terminals (0-10V) presert	0
	PD161	PID upper limit	0-100%	100%
	PD162	PID lower limit	0-100%	0%
Communication Function	PD163	Communication Addresses	0-250	0
	PD164	Communication Baud Rate	0-3	0
	PD165	Communication Data Method	0-5	0
	Pd166- Pd169	Reserved		

Monitor Function	PD170	Display Items	0-5	7
	PD171	Display Items Open	0-15	7
	PD172	Fault Clear	00 10(01 for Fault Clear)	*
	PD173	Voltage Rating of Inverter	Set according to the model	*
	PD174	Rated Current of Inverter	Set according to the model	
	PD175	Inverter Model		
	PD176	Inverter Frequency Standard	0: 50Hz 1: 60Hz	0
	PD177	Fault Record 1	Note: Means no fault record.	*
	PD178	Fault Record 2		—
	PD179	Fault Record 3		—
	PD180	Fault Record 4		—
	PD181	Software Version		—
	PD182	Manufacture Date	Year: Month: Week:	*
	PD183	Serial No.		*
	Pd184- Pd250	Reserved		

X. Descriptions of Functions

<p>PD000 Parameter Lock Set Range: 0-1 Unit: 1 Factory Setting: 0</p>

0: Invalid.
1: Valid, i.e. the parameters are locked. Except this parameter other parameters can not be changed.
This parameter is set to prevent non-maintenance personnel from setting other parameters by mistake.
After the parameters are locked the operating frequency can be changed by pressing Δ or \square .

<p>PD001 Source of Operation Commands Set Range: 0-2 Unit: 1 Factory Setting: 0</p>

0: Set by the Operator
Operation commands are given via the digital operator.
1: Set by external terminals.
Operation commands are given via external terminals, i.e. **multi-input terminals**



2: Set by communication ports.
Operation commands are given via communication ports.

PD002 Source of Operating Frequency
Set Range: 0-3 Unit: 1 Factory Setting: 0

0: Set by the operator. The operating frequency which given via the digital operator is Pd003.
1: Set by external terminals. Operating frequency is controlled by analog signals input via external terminals. The signal type is determined by PD070. For the related parameters refer to PD070-PD076.
2: The MODBUS is given. Operating frequency is given via the serial communication.

PD003 Main Frequency **
Set Range: 0.00-400.00 Hz Unit: 0.01 Hz Factory Setting: 0.00

In the digital operator mode, the inverter will run at the set value of PD003. During running, the operating frequency can be changed by pressing ▲ or ▼. During multi-speed running, the main frequency is taken as the frequency of Speed 1.

In the external control multi-speed mode, if PD002 is set to 1, i.e. given by an external terminal, Speed 1 will be given by the analog of the external terminal.

The setting of main frequency is limited by the maximum operating frequency.
The related parameters of PD002, PD080 are adjustable during operation.

PD004 Base Frequency
Set Range: 0.01-400.00 Hz Unit: 0.1 Hz Factory Setting: 50.00

This parameter must be set according to the rated frequency of operating voltage on the motor's nameplate. Under normal conditions do not change the set value of base frequency at will. If it is equipped with a special motor this value should be set properly according to the characteristics of the motor's parameters. Otherwise it may cause the damage to the equipment.

PD005 Max. Operating Frequency
Set Range: 10.00-400.00 Hz Unit: 0.01 Hz Factory Setting: 50.00

This parameter is set for the maximum operating frequency of the inverter.
The following are several curves and set values often used for reference. Specific curves must be set according to concrete characteristics of mechanical load.

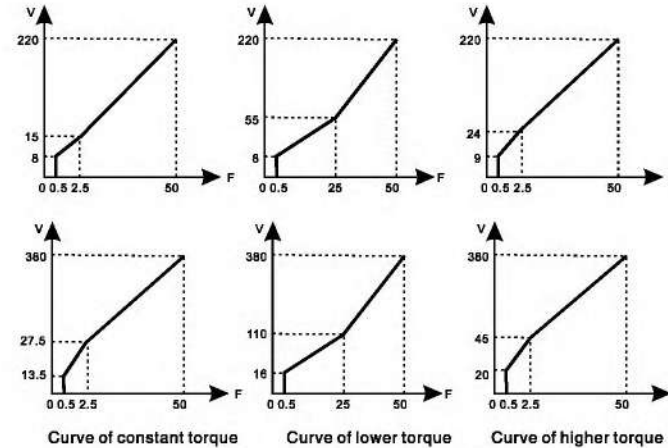

PD006 Intermediate Frequency
Set Range: 0.01-400.00 Hz Unit: 0.01 Hz Factory Setting: 2.50

Note: ** means this parameter is adjustable during operation.
This parameter is set for intermediate frequency of arbitrary V/F curve. If it is set improperly, it will cause over-current or under-torque of the motor, or even tripping of the inverter.
This set value of intermediate frequency is limited by the set value of base frequency.

PD007 Min. Frequency
Set Range: 0.12-0.00 Hz Unit: 0.01 Hz Factory Setting: 0.50

This parameter is set for the min. starting frequency of V/F curve.
The following table has specific factory settings of V/F curve, accel./decel., time and carrier for the inverter of AA-, AB-, AM series:

Code Model	Pd009	Pd010	Pd014	Pd015	Pd041	Code Model	Pd019	Pd010	Pd014	Pd015	Pd041
HY00D423B	15.0	7.5	5	5	9	003043A	17	8.5	30	30	4
HY007523B	14.0	7	8	8	9	003743A	16	8	35	35	4
HY01D523B	14.0	7	10	10	8	004543A	16	8	40	40	4
HY02D223B	13.0	6.5	10	10	8	005543A	15	7.5	45	45	3
HY03D723B	13.0	6.5	15	15	7	007543A	15	7.5	50	50	3
HY007543B	22	11	8	8	9	022043A	11	5.5	250	250	2
HY01D543B	22	11	10	10	8	025043A	11	5.5	250	250	2



Code Model	Pd009	Pd010	Pd014	Pd015	Pd041	Code Model	Pd019	Pd010	Pd014	Pd015	Pd041
HY02D243B	21	10.5	15	15	8	028043A	11	5.5	250	250	2
HY03D743B	21	10.5	15	15	7	030043A	10	5	250	250	2
HY05D643B	20	10	15	15	6	031543A	10	5	250	250	2
HY07D643B	20	10	20	20	6	034543A	10	5	250	250	2
HY11D043B	19	9.5	20	20	5	037543A	10	5	250	250	2
HY15D043B	19	9.5	20	20	5	040043A	10	5	250	250	2
HY18D643B	18	9	25	25	5	041543A	10	5	250	250	2
HY22D043B	18	9	25	25	5						

- Note:**
- ① Ramp Time 2 = Ramp Time 1 x 2
 - ② Ramp Time 3 = Ramp Time 2 x 2
 - ③ Ramp Time 4 = Ramp Time 3 x 2
 - ④ Min. Voltage Value = Intermediate Voltage Value/2
 - ⑤ The intermediate frequency is 2.5 for the system of 50Hz.
 - ⑥ The intermediate frequency is 3.0 for the system of 60Hz.

PD008 Max. Voltage
 Set Range: 0.1~* Unit: 0.1V Factory Setting: 220/380V

This parameter should be set according to the rated value of the motor's name plate. The factory setting is 380V for 380V class motor and 220V for 220V class motor. The setting range of this parameter is restricted by the voltage rating of the inverter. In case of the motor relatively far away from the inverter this set value can be increased properly.

PD009 Intermediate voltage
 Set Range: 0.15~10.0V Unit: 0.1V Factory Setting: *

This parameter is set for an intermediate voltage value of arbitrary V/F curve. If it is set improperly, it will cause over-current or under-torque of the motor, or even tripping of the inverter.

When the intermediate frequency is increased the voltage will increase the output torque and at the same time also the output current. When changing this parameter please pay attention to monitoring the output current to avoid the inverter's tripping due to over-current.

The factory setting of intermediate voltage for 220V class inverter is 15, while the factory setting of intermediate voltage of 380V class inverter is 27.5.

This set value of intermediate voltage is limited by the set value of max voltage. When the voltage is increasing to a certain value at intermediate frequency the torque compensation will lose its function.

When adjusting this parameter the output current of the inverter should be increased from low to high slowly according to the load of machines until it meets the starting requirement. Do not be quick to increase it by large amplitude. Otherwise it might cause the tripping of the inverter or the damage of the machines.

PD010 Min. Voltage
 Set Range: 0.1~50.0V Unit: 0.1V Factory Setting: *

This parameter is set for the min. starting voltage of V/F curve. The factory setting of min. voltage for 220V class inverters is 8, and the factory setting of min. voltage for 380V class inverters is 13.5. This set value is limited by the voltage at the max. Frequency.

PD011 Frequency Lower Limit
 Set Range: 0.00~400.00 Unit: 0.01 Hz Factory Setting: 0.00

This is set for preventing workers from false operation to avoid over-heat or some other mechanical faults, which might be caused due to too low operating frequency. The setting of Frequency Lower Limit must be less than the set value of Frequency Upper Limit.

PD012 Reserved

PD013 Parameter Reset

When the value for a parameter is set improper or is abnormal for some reasons this parameter can be set to 01 to restore it to the factory setting and then reset. After the parameters are locked (in case of PD000=1) the parameters can't be reset. They can only be reset after unlock. For related parameters refer to Pd000.

PD014 Accel. Time 1 **
 Set Range: 0.16~500.0S Unit: 0.1S Factory Setting: *

PD015 Decel. Time 1 **
 Set Range: 0.16~500.0S Unit: 0.1S Factory Setting: *

PD016 Accel. Time 2 **
 Set Range: 0.16~500.0S Unit: 0.1S Factory Setting: *

PD017 Decel. Time 2 **
 Set Range: 0.16~500.0S Unit: 0.1S Factory Setting: *

PD018 Accel. Time 3 **
 Set Range: 0.16~500.0S Unit: 0.1S Factory Setting: *

PD019 Decel. Time 3 **
 Set Range: 0.16~500.0S Unit: 0.1S Factory Setting: *

PD020 Accel. Time 4 **
 Set Range: 0.16~500.0S Unit: 0.1S Factory Setting: *

PD021 Decel. Time 4 **
 Set Range: 0.16~500.0S Unit: 0.1S Factory Setting: *



Ramp-up time means the time needed for the inverter to increase the frequency from 0Hz to the maximum operating frequency (See t1 in the diagram). Ramp-down Time means the time needed for the inverter to decrease the frequency from the maximum operating frequency to 0Hz (See t2 in the diagram).

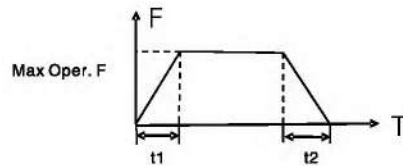

Note:

The versions previous to Vr2.0 took 50Hz as the base of ramp time. HY-A Series inverter have altogether 4 Ramp Times. For Ramp Time 2,3,4 the user can select the different ramp up or down time through the external terminals or switching of ramp time according to the actual needs. In the internal control multi-speed operation, different ramp time can be selected through easy PLC. Generally the default of the inverter is Ramp Time 1, which is factory set depending on the model. Ramp Time 4 is for the jogging ramp time. For the factory setting of parameters refer to the table in Pd007. The related parameters: PD044~PD049 and PD084,PD085

PD022	Factory Reserved
-------	------------------

PD023	Rev Rotation Select	Unit: 1	Factory Setting: 0
Set Range: 0-1			

0: Rev Rotation disable
1: Rev Rotation Enable
This function is suitable for the motor, which is not allowed to rotate reversely, to prevent workers from false operation. When the reverse rotation is disabled, the motor can only rotate forward, not reverse.

PD024	STOP key	Unit: 1	Factory Setting: 1
Set Range: 0-1			

0: STOP invalid.
1: STOP valid.
This parameter set is only valid when PD001 is set to 1 or 2.
When the control mode is set for external terminals or communication control, STOP key on the panel can be chosen to be valid or invalid. When choosing it as valid, STOP key can stop the inverter in running. When it needs to restart, the former running signal must be released before restarting the inverter.

PD025	Starting Mode	Unit: 1	Factory Setting: 0
Set Range: 0-1			

Two starting modes are available for the needs of different equipment.

0: Start from the starting frequency.
When PD029 is set to 0, i.e. DC braking is invalid at start, it starts running from the starting frequency. When PD029 is set to any non-zero value, i.e. DC braking is valid at start, it first performs a DC braking at start, and then starts from the starting frequency.
For the Related parameters refer to PD027, PD029 and PD031.

1: Start by frequency track
This setting can be used for the restarting of large inertia load. When restarting, the inverter will trace the former frequency from the set frequency downward. In case of large inertia equipment, when restarting, it can implement the running command and track the former frequency right away without waiting for the complete stop of the equipment to save time.

Note: When the inverter is restarted by frequency track, it will start tracking the frequency from its set frequency downward, and search it at the highest speed. When restarting, the current becomes higher, and over-current or stall may occur. So attention must be paid to the adjustment of current level of frequency track. Generally, PD033 is adjusted around 100. The concrete value can be set according to the characteristics of mechanical load.

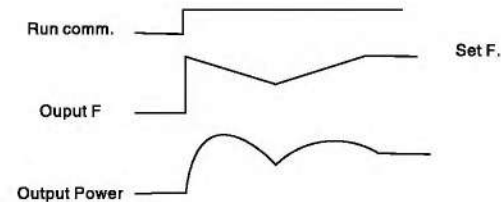

PD026	Stopping Mode	Unit: 1	Factory Setting: 0
Set Range: 0-1			

0: Decelerating Stop
When PD030 is set to 0, DC braking is invalid. When DC braking is invalid, the inverter will decelerate to the stopping frequency, and then stop outputs, and the motor will coast to stop. When PD030 is set to any non-zero value, DC braking is valid, and the inverter will first decelerate to the stopping frequency, and then stop by DC braking.

DC braking at stop is usually used for high position stop or for positioning control. It must be noticed that frequent uses of DC braking will cause over-heat of the motor.
For the related parameters refer to PD028, PD030 and Pd031.

1: Coasting Stop
When the inverter receives a STOP command, it will immediately stop output and the motor will coast to stop. When the coasting stop mode is selected, DC braking is invalid.

PD027	Starting Frequency	Unit: 0.1Hz	Factory Setting: 0.5
Set Range: 0.1-10.0 Hz			



Starting frequency is the initial frequency when the inverter is started. If the starting frequency is set to 5.0Hz, the inverter will run between 5.0 Hz and the maximum operating frequency after its start at 5.0Hz.

For the related parameters refer to PD025, PD029 and PD031.

PD028 Stopping Frequency			
Set Range: 0.1–10.0 Hz	Unit: 0.1Hz	Factory Setting: 0.5	

When stopping the inverter will decrease its frequency to the stopping frequency and then stop running or start DC braking to stop.

If PD030 is set to 0, DC braking is invalid at stop and the inverter will stop running.

If PD030 is set for valid, the inverter will stop by DC braking when the inverter reduce to PD028. For the related parameters refer to PD026, PD031 and Pd030.

PD029 DC Braking Time at Start			
Set Range: 0.02–5.0S	Unit: 0.1S	Factory Setting: 0.0	

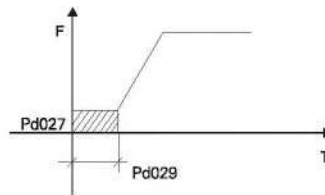

This parameter is set for DC braking at start and the lasting time of DC braking current to the motor. If it is set to zero it means DC braking is invalid. DC braking at start is normally used in the application, in which the load is movable when the machine is at stop, such as windmill. Because of the load existing before the inverter drives, the motor is often in coasting with an uncertain rotation direction. So the DC braking can be executed before starting the motor to prevent the inverter from tripping.

This setting is valid only when PD025 is set to 0. For the related parameters refer to PD025, PD029 and Pd031.

PD030 DC Braking Time at stop			
Set Range: 0.0–25.0	Unit: 0.1S	Factory Setting: 0.0	

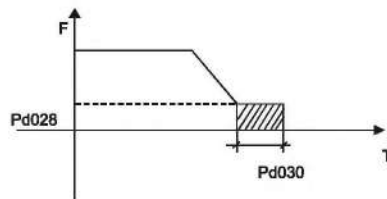

Note: When this parameter is set to any non-zero value it starts DC brake at stop and sends the DC braking time to the motor. DC braking at stop is often used for a high-level stop or positioning control. When this parameter is set to zero it closes DC braking at stop.

This setting is valid when PD026 is set to 0. For the related parameters refer to PD026, PD028 and Pd031.

PD031 DC Braking Voltage Level			
Set Range: 0.0–20.0%	Unit: 0.1%	Factory Setting: 2.0	

This parameter is set for the DC braking voltage to the motor at start and stop. It can be adjusted for different braking voltage. When adjusting the parameter it must be increased slowly from lower value to high value until the sufficient braking torque is achieved.

The voltage at maximum frequency is 100% voltage.

PD032 Frequency Track Time			
Set Range: 0.12–0.0S	Unit: 0.1S	Factory Setting: 5.0	

This parameter is set as frequency track time when the inverter is started by frequency track after an external abnormality or temporary power breakdown. For starting or stopping of some large inertia load, if restarting a machine after its complete stop, it will waste much time because of its large inertia of load. But if the frequency track is started, it is not necessary to wait for the machine to come to a full stop for restart. The inverter will trace the frequency from high to low with the set frequency. After searching it will continue to accelerate to reach the set frequency.

PD033 Current Level for Frequency Track			
Set Range: 0–200%	Unit: 1%	Factory Setting: 150	

When the inverter is tracing the frequency this set value is taken as the level for output current. When the output current is higher than this level the inverter will decrease the frequency to restore the current below the level and then it will execute the frequency track again.

PD034 Inverter Track Time of Up/down	Factory Setting: 0.5
---	----------------------

When the inverter is started by frequency track, in the track process, the voltage will up, when the voltage up-speed increase, the current will higher, the track process will faster. When the voltage up-speed decrease, the current will lower, the track process will slower. The generally setting way is the low power machine establishes small, the high power machine establishes big.

PD035 Pd040 Reserved

PD041 Carrier Frequency	(Note: 015 corresponds to 020K Hz)
Set Range: 0–15	Unit: 1 Factory Setting: 5

The carrier frequency has some relation with the electromagnetic noise of the motor, and mean while the level of the carrier frequency has certain relation with the heating capacity of the inverter and the interference to the environment. See the following table:

Carrier Frequency	Electromagnetic Noise	Heating Capacity	Interference to the Environment
Low	High	Small	Little
↓	↓	↓	↓
High	Low	Large	Great



Carrier Frequency Corresponding Table

Set Value	0	1	2	3	4	5	6	7	8	9	10	11	12	13	14	15
Carrier Frequency Khz	0.1	1	1.5	2	3	4	5	7	8	9	10	11	13	15	17	20

As shown in the table above, the higher the carrier is, the lower the electromagnetic noise of the motor will be, but the stronger its interference to other systems will be and the greater the heating capacity of the inverter will have. Under higher ambient temperature and heavier load of the motor the carrier frequency should be decreased properly to improve the heat characteristics of the inverter. The factory setting of carrier frequency is depending on the model.

PD042 Jogging Frequency			**
Set Range: 0.00–400.00	Unit: 0.01	Factory Setting: 5.00	

The parameter set can realize the jogging function when the inverter is tested. The jogging operation can be only achieved through the external terminals, which can be set by multi-input terminals. Jogging frequency is limited by the frequency upper/lower limits. While the jogging function is implemented, other running commands are invalid. The ramp-up time of jogging frequency is set by Ramp-up Time 4. When the jog button is released the inverter will stop output immediately. In case of jogging function please set the corresponding multi-input terminals to 07 or 08.

This function is only valid at stop. It is invalid at running. For the related parameters refer to PD044-PD049.

PD043 S-Curve Time			
Set Range: 0–6500S	Unit: 1	Factory Setting: 1	

This parameter can be set for no impact slow start or slow stop of the inverter when starting or stopping. When starting S-curve the inverter will make accelerating or decelerating curve of different speed rates according to Ramp Time.

When PD043 is set as 0, S-curve is invalid, i.e. it will accelerate or decelerate in linear. Without consideration of stall the actual accel/decal time = (PD014+PD043)/2. The parameter is only valid when Pd014 is less than Pd043.

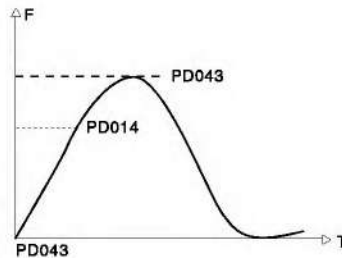

PD044	FOR (D1) Function	Factory Setting: 02
Pd045	REV (D2) Function	Factory Setting: 03
Pd046	RST (D3) Function	Factory Setting: 04
Pd047	SPH (D4) Function	Factory Setting: 07
Pd048	SPM (D5) Function	Factory Setting: 19
Pd049	SPL (C6) Function	Factory Setting: 20
	Set Range: 00–32	Unit: No

- 01: RUN Running. It can be combined with other terminals to compose multiple control modes.
- 02: FOR Forward Rotation
- 03: REV Reverse Rotation
- 04: STOP Stopping
- 05: FOR/REV Switching of FOR/REV rotation
- 06: JOG Jogging
- 07: Jog FOR
- 08: Jog REV
- 09: External Control Timer 1 Start: When the contact is closed, the timer will start and begin to count time. When the timer reaches the set point the corresponding multi-inputs will act.
- 10: External Control Timer 2 Start.
- 12: Over-heat of heat sink or motor: This contact can be used to detect over-heat of the heat sink or motor to protect the motor and inverter.
- 13: Emergent Stop: Emergent stop. It can receive external emergent stop command or other fault signals.
- 14: Reset: This terminal can be used for reset after a fault is removed.
- 15–16: Reserved.
- 17: Ramp Time 1: This terminal can be used to select the ramp time of the inverter.
- 18: Ramp Time 2: 4 kinds of ramp time are available for choice.
- 19: Multi-speed 1: 8-speed setting can be composed through Multi-speed 1, 2, 3.
- 20: Multi-speed 2
- 21: Multi-speed 3
- 22: High speed: High, middle and low speed can compose three kinds of operation mode
- 23: Middle speed with different frequencies. In the three terminals the high-end signal has
- 24: Low speed priority. Low, Middle and High Speed are determined respectively by Frequency 2, 3, 4.
- 25: PID Valid: When this contact is closed, PID function starts. PID Function start is only valid during operation.
- 26: PLC Reset Suspend: This contact can be used to achieve the function of AutoPLC clear suspend.
- 27: UP Function: When the switch of this terminal acts the frequency setting of the inverter will be increased or decreased by one unit. When the switch of the terminal is hold the frequency will increase or decrease rapidly to a point and then increase or decrease.



- 28: Down Function at even speed. When the power is up again after the power breakdown the changed frequency will not be memorized.
- 29: Drawing Start When this contact is triggered the drawing action starts.
- 31: Pulse Counter When this terminal is set for the counter it can receive the pulse signal of $\leq 250\text{HZ}$ and counts.
- 32: Counter Reset When this contact acts it will clear the present counting values displayed, restore C00 and restart counting.

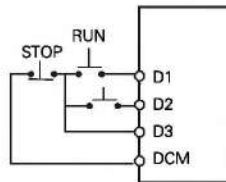

Explanation:

1. Three multi-function terminals can be used for the connection method of three-wire system for the realization of switching of FOR/REV rotation, which is extensively applied in the cases of FOR/REV switching of photoelectric switches.

- ① Select the multi-function terminals of D1、D2 and D3
- ② Parameter setting:
PD001=1 for external control PD044=02 for FOR rotation
PD045=03 for REV Rotation PD046=04 for Stop
- ③ Action Description:
When triggering D1, the inverter will rotate forward (start);
When triggering D2, the inverter will rotate reverse;
When pressing STOP, the inverter will stop.

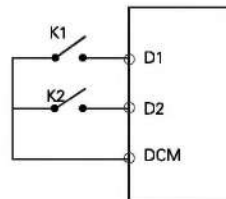

2. RUN, DCM, F/R can be used for Start, Stop and switching of FOR/REV:

- ① Select the terminals of D1 and D2
- ② Parameter setting:
PD001=1 for external control
PD044=01 for RUN function
PD045=05 for switching of F/R
When K2 is opened it rotates forward, while K2 is closed it rotates reverse.

3. Description of Ramp Time 1 and 2:

- ① This function is only valid when PD080 is set to 0, 2 and 3. Under the disturbance and internal control multi-speed it is invalid.
- ② Any two multi-inputs can be combined for 4 kinds of ramp time for selection.
- ③ The related multi-inputs are set for Ramp Time 1, 2. Take the terminals of D4 and D5 as example, when the terminal of D4 PD047 is set to 22 and the terminals of D5 PD048 is set to 23, D4 and D5 are now Ramp Time 1, 2.

D4	D5	Result
OFF	OFF	Ramp Time 1
ON	OFF	Ramp Time 2
OFF	ON	Ramp Time 3
ON	ON	Ramp Time 4

4. Function description of High, Middle and low speed terminals:

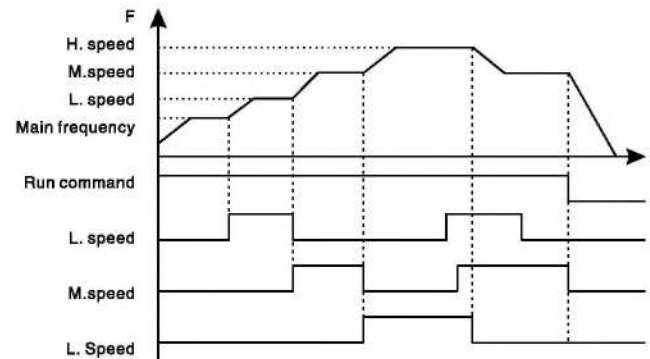

RUN	D6	D5	D4	Result
ON	OFF	OFF	OFF	Main speed, the frequency runs at the set value of Pd003.
ON	ON	OFF	OFF	Low speed, the frequency runs at the set value of Pd086.
ON	ON/OFF	ON	OFF	Middle speed, the frequency runs at the set value of Pd087.
ON	ON/OFF	ON/OFF	ON	High speed, the frequency runs at the set value of Pd088.

Notes:

- (1) This function is only valid when PD080 is set to 2, i.e. for 4-Speed of external control.
- (2) Ramp time is determined by Ramp Select terminal.
- (3) When all high, middle and low speeds have signal inputs it will give priority in the sequence of high, middle and low speed.



5. Description of UP and DOWN Function:

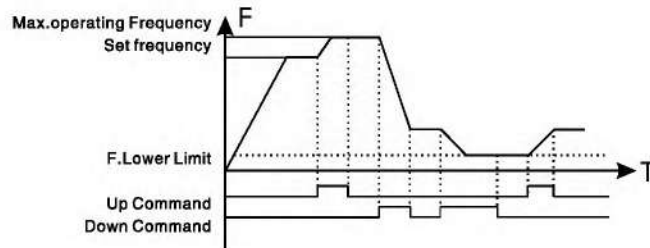

UP	DOWN	Result
ON	OFF	Frequency increase
OFF	ON	Frequency decrease
ON	ON	Not increase or decrease

Note:

- (1) The function of UP and DOWN is only valid when the operator is selected for the source of the operating frequency, i.e. PD002=0.
- (2) When the UP terminal is closed the frequency of the inverter will increase.
- (3) When the DOWN terminal is closed the frequency of the inverter will decrease.
- (4) When both UP and DOWN terminals are closed at the same time the frequency will neither increase nor decrease. It is regarded as invalid.
- (5) When the frequency reaches the max operating frequency it will stop increasing.
- (6) When the frequency reaches the min frequency or its lower limit, it will stop decreasing.
- (7) After a power breakdown the set value of PD003 will be memorized instead of the frequency.
- (8) When using the function of UP and DOWN, the keys of Δ \square of the panel are valid. After changing the values it needs to press SET (ENTER) key for confirmation and then the inverter can implement the action. Meanwhile the value will write to PD003, which will be memorized after a power breakdown.
- (9) When keeping pressing UP or DOWN, the frequency will increase or decrease rapidly to a point and then increase or decrease at even speed.
- (10) The value changed by UP or DOWN can be set through PD077 for confirmation of whether it should be memorized or not memorized. For details refer to Pd077.

6. Function Description of Counter:

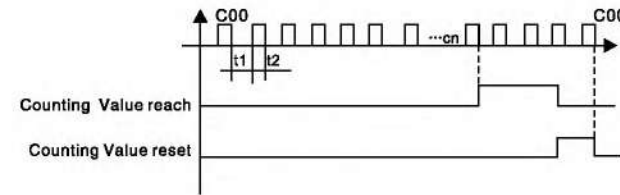

Note:

- (1) The signal width triggered should not be lower than 2 msec ($t_1, t_2 \geq 2\text{msec}$).
- (2) When the counting value is reached the corresponding multi-output contact will act.
- (3) This counter can only count again after reset.
- (4) When reaching to 65535 the counter will not count again.

PD050	Y1-input Function	Factory Setting: 01
PD051	Y2-input Function	Factory Setting: 03
PD052	FA, FB, FC Input Function	Factory Setting: 01
PD053	Ka, KB Input Function	Factory Setting: 03
	Set Range: 00-32	Unit: 1

- 01: In Run: The contact will act when the inverter has output or receives the running command.
- 02: Zero Speed: The contact will act when the output frequency of the inverter is less than its starting frequency.
- 03: Fault Indication: The contact will act when the inverter detects abnormal conditions.
- 04: DC Braking Indication: The contact will act when the inverter is in DC braking.
- 05: Set Frequency Reach: The contact will act when the output frequency of the inverter reaches the set frequency.
- 06: In Accel: The contact will act when the inverter is in ramp-up.
- 07: In Decel: The contact will act when the inverter is in ramp-down.
- 08: Uniform Frequency 1 Reach: The contact will act when the output frequency of the inverter reaches the designated frequency (PD060).
- 09: Uniform Frequency 2 Reach: The contact will act when the output frequency of the inverter reaches the designated frequency (PD061).
- 10: Motor Overload Alarm: The contact will act when the inverter detects over-load of the motor.



- 11: Over-torque Detect: The contact will act when the inverter detects over-torque.
- 12: Inverter Over-load Alarm: The contact will act when the inverter detects over-load.
- 13: Set Counter Reach: The contact will act when the inverter implements the external counter and the counting value is equal to the set value (PD065).
- 14: Middle Counter Reach: The contact will act when the inverter implements the external counter and the counting value is greater than or equal to the set value (PD066).
- 15: External Control Timer 1 reach: The contact will act when the timer 1 reaches the set value..
- 16: External Control Timer 2 reach: The contact will act when the timer 2 reaches the set value
- 17: Low Voltage Alarm: The contact will act when the inverter detects low voltage.
- 18: Single Step End: The contact will act and generate one pulse when the inverter finishes a single step in implementation of program operation.
- 19: Process End: The contact will act and generate one pulse when the inverter finishes all the steps (i.e. after one cycle) in implementation of program operation
- 20: 4~20mA disconnected: When AI input signal is disconnected and PD072 more than 2, the contact will act.
- 25: Auxiliary Pump 1: This contact controls the starting and stopping of auxiliary pumps. For details refer to Operation of Multi-pumps.
- 26: Auxiliary Pump 2
- 27: Drawing reach: The contact will act when the drawing action is finished. The contact will auto matically reset when the inverter stops.
- 28: PID Lower Limit Alarm: This contact will act when the PID feedback is smaller than the lower limit (the set value of PD162).
- 29: PID Upper Limit Alarm: This contact will act when the PID feedback is greater than the upper limit (the set value of PD161).
- 30: Braking Resistor Act: When the inverter is in running and the DC voltage reaches the braking voltage the contact will act.
- 31: Electromagnetic Relay Act: When the contact pulls in, the corresponding multi-function terminal will act.
- 32: Fan act: When the temperature of the inverter is increased or it is in running, this contact will act.

PD054 Vo Input			
Set Range: 0~7	Unit: 1	Factory Setting: 0	

Functions: Output terminal of digital frequency, generating pulse or 010V analog. In combination with Pd055 it can be connected with a corresponding instrument with the measuring range below 10 to be used for external monitoring.

- 0: 0~10V analog output, corresponding to output frequency. 0~10V corresponds to 0~Maximum operating frequency
 - 1: 0~10V analog output, corresponding to output current. 0~10V corresponds to 0~two times of the rated current of the inverter.
 - 2: Analog output, corresponding to DC bus voltage. 0~10V corresponds to 0~1000V.
 - 3: Analog output, corresponding to AC output voltage. 0~10V corresponds to 0~510V/255V.
- (Note: The machine type of three phase, 380V corresponds to 510V and the machine type of single phase, 220V corresponds to 255V)

PD055 Vo Analog Output Gain			
Set Range: 0.0~100.0%	Unit: 0.1%	Factory Setting: 100.0	

This parameter can be used to adjust the output voltage value of Multi-output 6 to adapt to frequency meters with different measuring range and also used to correct a frequency meter. For example, for an externally connected frequency meter with the measuring range of 0~5V, a multi-function terminal can be used to display its operating frequency. Then it can be corrected with this parameter. It can be achieved by setting PD055=50.

PD056 Skip Frequency 1			**
PD057 Skip Frequency 2			
PD058 Skip Frequency 3			
Set Range: 0.00~400.00 Hz	Unit: 0.01Hz	Factory Setting: 0.0	
PD059 Skip Frequency Range			**
Set Range: 0.10~10.00 Hz	Unit: 0.01Hz	Factory Setting: 0.5	

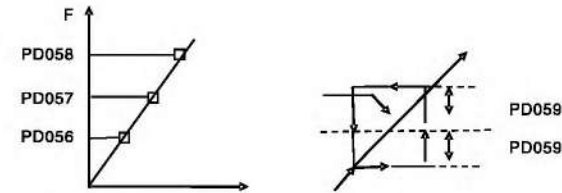

These three frequency skipping points are set for avoiding a mechanical resonance point. In case of PD059=0, all skip frequencies are invalid. The actual skip frequency range is two times that of PD059, as shown in the above diagram.

PD060 Uniform Frequency 1			**
PD061 Uniform Frequency 2			
Set Range: 0.00~400.00 Hz	Unit: 0.01 Hz	Factory Setting: 0.00	
Pd062 Uniform Frequency Range			**
Set Range: 0.10~10.00 Hz	Unit: 0.01 Hz	Factory Setting: 0.50	

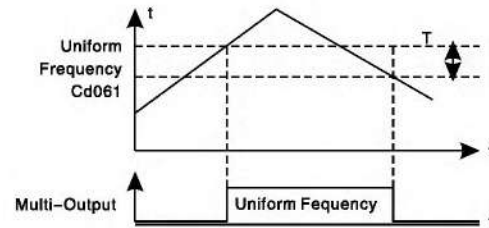



When the output frequency is more than the uniform frequency the corresponding multi-outputs will act. The uniform frequency range acts as a hysteresis loop.

When the inverter is in the operation of multi-pumps, PD060 is used as high speed frequency and PD061 is set as low speed operating frequency. The definitions of the corresponding multi-function contacts are changed.

PD063 Timer 1 Time			
Set Range: 0.1 ~ 10.00	Unit: 1	Factory Setting: 0.1	
PD064 Timer 2 Time			
Set Range: 1 ~ 100	Unit: 1	Factory Setting: 1	

Timer 1 is a timer of 0.1s ~ 10.0s and Timer 2 is a timer of 1s ~ 100s. When the timer start at multi-inputs is closed (on) the timer starts to count time. When it reaches the set time the corresponding multi-output contact will act. When the timer start is opened (off) the timer time at the multi-output will be reset.

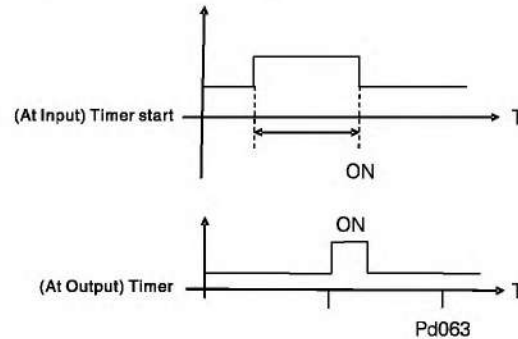

For example, set PD063=5.0s. When the external control terminal (Multi-Input) is valid the output terminal will be valid after five (5.0) seconds, the signal of which can be used to control other corresponding signals.

PD065 Counting Value		**
Set Range: 0~65500	Unit: 1	Factory Setting: 0

An external terminal of multi-function can be used as a trigger for the counter. When the counter reaches the set value of PD065 the corresponding multi-output contact will act. After the counter is cleared and reset it will start counting again. A proximity switch or optoelectronic switch can be used for the triggering signals.

PD066 Intermediate Counter		
Set Range: 0~65500	Unit: 1	Factory Setting: 0

Refer to PD065.

PD067 PD069	Reserved
-------------	----------

PD070 Analog Input		
Set Range: 0~4	Unit: 1	Factory Setting: 0

0: 0~10V 1: 0~5V 2: 0~20mA
 3: 4~20mA 4: 0~10V 4~20mA stacked
 This parameter can be set for different analog input signals.
 When PD070=4, the output frequency = 1/2 (U/Umax + I/Imax) × 50Hz
 Among which: U: Analog Voltage Umax: Maximum Analog Voltage
 I: Analog Current Imax: Maximum Analog Current

PD071 Analog Filtering Constant		
Set Range: 0~50	Unit: 1	Factory Setting: 20

The setting of this parameter is related to the analog responding speed. The higher the value of PD071 is set, the lower the analog responding speed will be.

PD072 Higher Analog Frequency			
Set Range: 0.00~400.00 Hz	Unit: 0.01Hz	Factory Setting: 50.00	
PD073 Lower Analog Frequency			
Set Range: 0.00~400.00 Hz	Unit: 0.01 Hz	Factory Setting: 0.00	
PD074 Bias Direction at Higher Frequency			
Set Range: 0~1	Unit: 1	Factory Setting: 0	
PD075 Bias Direction at Lower Frequency			
Set Range: 0~1	Unit: 1	Factory Setting: 0	

0: Positive direction
 1: Negative direction
 Bias direction means the instruction of FOR/REV rotation command. Positive bias indicates forward rotation while negative bias indicates reverse rotation. For details refer to the diagram in Pd076.

PD076 Analog Negative Bias Reverse		
Set Range: 0~1	Unit: 1	Factory Setting: 0

0: Negative bias Rev is not allowable.
 1: Negative bias Rev is allowable.
 The parameter group is set for the measuring range and zero point of the external analog terminals and can be combined for any kind of curve to control the operation of the motor.

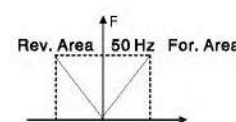

Setting: PD073=50 PD075=1 PD072=50
 PD074=0 PD076=1

Note: this curve can be easily used in complicated applications in combination with other curves. When using it the instruction of FOR/REV run from external terminals is still valid. When switching, the curve will turn reverse.

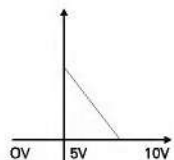

Setting: PD073=50 PD075=1 PD072=50
PD074=0 PD076=1

Note: this curve is a kind of special application of reverse ramp setting. When using transmitter for the control of pressure, temperature and others and while the control has higher pressure and output signals but requiring the corresponding commands of stop or deceleration on the inverter this curve can satisfy the demand properly.

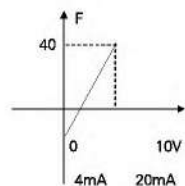

Setting: PD073=50 PD075=1 PD072=50
PD074=0 PD076=1

Note: this method is used extensively. The user can use it flexibly.

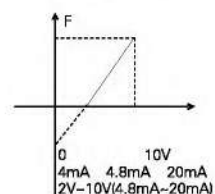

Setting: PD073=10 PD075=1 PD072=50
PD074=0 PD076=0

Note: the signal of 0Hz-40Hz (4-4.8mA) is invalid. It can be used to avoid noise disturbance. In harsh environment it is better not to use signals below 1V for setting the operating frequency of the inverter.

PD077 UP/DOWN Function

Set Range: 0-1 Unit: 1 Factory Setting: 0

0: Not memorized 1: Memorized

This parameter can be set for the selection of whether the values changed by the UP or DOWN shall be memorized or not after stop. The changed values whether to be memorized or not means when they are changed by UP or DOWN during operation and the inverter is restarted after stop these changed values shall be memorized or not after restart. When PD077 is set to 0, the changed value will not be memorized and when it is set to 1, the changed values will be memorized. The set values of PD003 will be memorized after restart.

For the related parameters refer to PD044-PD049.

PD078 UP/DOWN Speed

Set Range: 0-1 Unit: 1 Factory Setting: 0

0: 0.01Hz. Minimum UP/DOWN speed is 0.01Hz.

1: 0.1Hz. Minimum UP/DOWN speed is 0.1Hz.

Through the changes of this set value the UP/DOWN speed unit can be adjusted to meet the needs of different customers.

PD079 Reserved

PD080 PLC Operation

Set Range: 0-5 Unit: 1 Factory Setting: 0

0: Normal operation, i.e. the inverter is running in the normal control mode.

1: Internal control Multi-speeds(16-speeds)

Note:

① Main speed and 7-speeds composes 8-speeds.

② The ramp time of each speed step is set by PD084, PD085.

③ Running Time is set by Timer PD101~PD116. For the control steps not to be used the timer can be set to 0.

④ Running direction of each speed step is determined by PD082, PD083.

⑤ In the internal control multi-speed operation the running time and direction are determined by the setting of internal parameters. Any switching of external time and FOR/REV rotation is invalid.

2: External control 4-Speeds (Refer to the function description and diagram of three terminals of high, middle and low speed in PD044~PD049)

3: External control Multi-speeds

Multi-function Terminals			Results
Multi-speed 1	Multi-speed 2	Multi-speed 3	
OFF	OFF	OFF	Main frequency and frequencies are determined by PD003 or potentiometer.
ON	OFF	OFF	Multi-speed 1 and frequency are determined by PD086.
OFF	ON	OFF	Multi-speed 2 and frequency are determined by PD087.
ON	ON	OFF	Multi-speed 3 and frequency are determined by Pd088.
OFF	OFF	ON	Multi-speed 4 and frequency are determined by PD089.
ON	OFF	ON	Multi-speed 5 and frequency are determined by PD090.
OFF	ON	ON	Multi-speed 6 and frequency are determined by PD091.
ON	ON	ON	Multi-speed 7 and frequency are determined by Pd092.

Note:

① It is only valid to realize the external control 8-Speeds operation when Multi-inputs are set for Multi-speed 1, 2, 3 and PD080 is set to 3.

② Multi-speed 1, 2, 3 can be used to make up 7-Speeds and 8-Speeds adding the main frequency.

③ The frequencies of Speed Step 1 ~ Step 7 are determined by PD086~PD092.

④ Each ramp time is determined by the external multi-function terminal D1-D6.

⑤ The directions of each program operation are determined by the external multi-function terminals D1-D6.

⑥ The main frequency can be set in two ways. One method is to set it through PD003 and another is to set it through the potentiometer. When PD002 is set to 1 the frequency of Main Frequency is set by the potentiometer. For the related parameters refer to PD003, PD002 and PD086~PD092.



4: Drawing

This is a special parameter for the constant speed of unwinding and rewinding. By using this function the linear speed constant in certain accuracy can be realized.

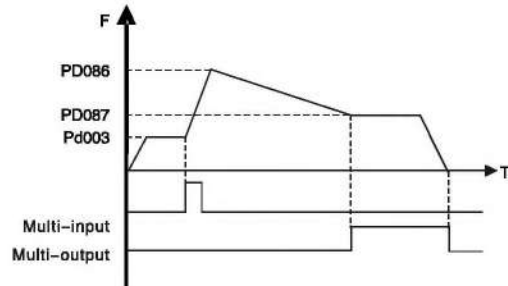

Note:

- ① Through triggering of the external multi-function terminal the drawing action begins.
- ② In implementation of the drawing action the actual running time is $T = PD101 \times 10$.
- ③ when the drawing action is finished the inverter will run at the constant speed of PD087 and the corresponding multi-output contact will act at the same time. Until receiving the STOP command the inverter will stop running and the multi-output contact will reset.

5: Disturbance (Traverse function)

This is a special parameter in the chemical fiber and printing and dyeing industries to realize the traverse function. Except the commands of stop, external faults and emergency stop all other commands are not accepted at running.

Note:

- ① The frequency at each inflection point is determined by PD003 and PD086.
- ② Skip Frequency is determined by PD092.
- ③ Running Time is determined by Timer PD101 and PD102.
- ④ The related parameters: PD003, PD086~PD116.

PD081 Auto PLC
Set Range: 0-3 Unit: 1 Factory Setting: 0

- 0: Stop after the program runs one cycle.
- 1: Cycling running.
- 2: Stop after it runs one cycle automatically (STOP for intervention).
- 3: Auto running and cycling (STOP for intervention)
This parameter setting is only valid when PD080 is set to 4. For relevant parameters refer to PD003, Pd080 and CD082~PD116.

Explanation:

1. Stop after the program runs one cycle.
When the command of auto program operation is given, the inverter will run with each set value of internal parameters. It will run for one cycle and then stop automatically. The inverter will not restart and run until it receives another command of operation.
2. Cycling run.
When the command of operation is given, the inverter will run in sequence with the frequency of every speed step and running time set by each of the internal parameters and will recycle. During the cycling run, except the commands of stop, external faults and emergency stop, all other commands will not be accepted.
3. Stop after it runs one cycle automatically (STOP for intervention)

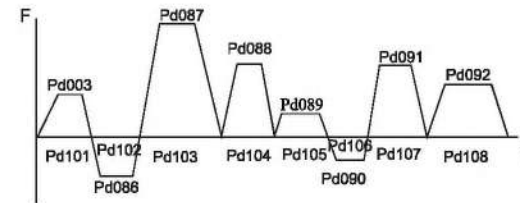

Note:

- ① When the command of auto program operation is given the inverter will run with each parameters. But it will stop first and then restart at changing of each step and will stop automatically after running for one cycle. The inverter will not restart and run until it receives another command of operation.
- ② The frequencies of each speed step are set by PD003 and PD086 ~ PD092.
- ③ The running times of each speed step are set by PD101 ~ PD108.
- ④ The running direction is set by P082

PD082 PLC Running Direction of the Front 8-Speeds
PD083 PLC Running Direction of the Follow 8-Speeds
Set Range: 0-255 Unit: 1 Factory Setting: 0

This parameter is only valid when PD080 is set to 1 This parameter setting determine the running direction of each frequency of PD086~PD092 and PD003 in the program operation. The setting method is as follows:

The rotation direction is set first in the binary 8 bits mode, and then converted to a decimal value for the setting of this parameter. For instance:

The parameter value 01001010 is converted to a decimal value:
 $1 \times 2^7 + 1 \times 2^6 + 1 \times 2^2 = 64 + 8 + 2 = 74$
 Then PD082=74
 PD083 means that set running direction of the follow 8-speeds (the algorithm likes Pd082)

PD084 Ramp Time of the Front 8-Speeds



PD085 Ramp Time of the Follow 8-Speeds
 Set Range: 0-65535 Unit: 1S Factory Setting: 0

This parameter is only valid when PD080 is set to 1.
 This parameter is set to determine the ramp time values for the internal control multi-speed and each speed. The setting method is as follows:

① Determine each Ramp Time in the binary 2 bit mode

Bit1	Bit0	Ramp Time
0	0	Ramp Time 1 PD014, PD015
0	1	Ramp Time 2 PD016, PD017
1	0	Ramp Time 3 PD018, PD019
1	1	Ramp Time 4 PD020, Pd021

② Determine the Ramp time of each speed step in the binary 16 bit mode

Step 8	Step 7	Step 6	Step 5	Step 4	Step 3	Step 2	Step 1
t8	t7	t6	t5	t4	t3	t2	t1
0	0	0	0	0	1	1	0
0	0	0	0	0	0	0	1

- t1 Select Ramp Time 4
- t2 Select Ramp Time 1
- t3 Select Ramp Time 3
- t4 Select Ramp Time 2
- t5 Select Ramp Time 1
- t6 Select Ramp Time 1
- t7 Select Ramp Time 1
- t8 Select Ramp Time 1

The setting value:
 $1 \times 2^8 + 1 \times 2^7 + 1 \times 2^6 + 1 \times 2^5 = 99$
 So PD084 is set to 99
 Attach: $2^0=1$ $2^1=2$ $2^2=4$ $2^3=8$
 $2^4=16$ $2^5=32$ $2^6=64$ $2^7=128$

PD085 means that set ramp time of the follow 8-speeds(the algorithm likes Pd084)

PD086	Frequency 2	Factory Setting	15
PD087	Frequency 3	Factory Setting	20
PD088	Frequency 4	Factory Setting	25
PD089	Frequency 5	Factory Setting	30
PD090	Frequency 6	Factory Setting	35
PD091	Frequency 7	Factory Setting	40
PD092	Frequency 8	Factory Setting	0.5

PD093	Frequency 9	Factory Setting	10
PD094	Frequency 10	Factory Setting	15
PD095	Frequency 11	Factory Setting	20
PD096	Frequency 12	Factory Setting	25
PD097	Frequency 13	Factory Setting	30
PD098	Frequency 14	Factory Setting	35
PD099	Frequency 15	Factory Setting	40
PD100	Frequency 16	Factory Setting	45
Set Range: 0.00-400.00 Hz		Unit: 0.01 Hz	

This parameter is set for cooperate the multi-terminals , can choose the external 4-speeds/the external control multi-speeds and the internal control multi-speeds.For the relevant parameter refer to PD080 and PD086-PD100

PD101	Timer 1	Factory Setting	10.0
PD102	Timer 2	Factory Setting	10.0
PD103	Timer 3	Factory Setting	0.0
PD104	Timer 4	Factory Setting	0.0
PD105	Timer 5	Factory Setting	0.0
PD106	Timer 6	Factory Setting	0.0
PD107	Timer 7	Factory Setting	0.0
PD108	Timer 8	Factory Setting	0.0
PD101	Timer 9	Factory Setting	0.0
PD102	Timer 10	Factory Setting	0.0
PD103	Timer 11	Factory Setting	0.0
PD104	Timer 12	Factory Setting	0.0
PD105	Timer 13	Factory Setting	0.0
PD106	Timer 14	Factory Setting	0.0
PD107	Timer 15	Factory Setting	0.0
PD108	Timer 16	Factory Setting	0.0
Set Range: 0.06500.0S		Unit: 0.1S	

This parameter is set for the internal control multi-speeds and the running time of drawing function. For the relevant parameter refer to PD080 and PD101-PD116.

Pd117 Internal Control Multi-Speeds Memory Function
 Set Range: 01 Factory Setting: 0

- 0: Not memorized
- 1: Memorized



This parameter is set to determine whether the inverter is to realize the suspending function in Auto PLC mode. In case of PD115=1 it can memorize the status in which the inverter is running and will memorize it at stop or fail. It will continue to run when returning to normal. In case of PD115=0 it will not memorize.

PD118 Over-voltage Stall Prevention		
Set Range: 0-1	Unit: 1	Factory Setting: 1

- 0: Over-voltage stall prevention invalid
- 1: Over-voltage stall prevention valid.

When the inverter is in deceleration, due to the effect of load inertia, the motor will produce a return energy to the inverter and cause the DC voltage of the inverter to increase. So when the function of over-voltage stall prevention is started, if the DC voltage of the inverter becomes too high, the inverter will stop decelerating till the voltage at DC decreases below the set value, then the inverter will go on to decelerate and the ramp-down time will be extended automatically.

PD119 Stall Prevention Level at Ramp-up		
Set Range: 0-200%	Unit: 1%	Factory Setting: 150

When the inverter is in ramp-up, due to overload or too short ramp-up time, the output current of the inverter will go up quickly and exceed the set standard level. When this happens, the inverter will stop accelerating. When the current returns under its set value, the inverter will go on to accelerate.

100% current is the rated current of the motor. When this parameter is set to 0, the stall prevention function is invalid.

PD120 Stall Prevention Level at Constant Speed		
Set Range: 0-200%	Unit: 1%	Factory Setting: 0

When the inverter is running at constant speed, due to load fluctuation and other reasons, the current will increase. When the current exceeds its set standard value, the inverter will lower the output frequency. When the output current returns to its normal range, the inverter will accelerate again to its set frequency.

100% current is the Rated Current of the motor. When this parameter is set to 0 the stall prevention function is invalid.

PD121 Decel. Time for Stall Prevention at Constant Speed	Factory Setting: 5.0
--	----------------------

When the inverter is used for the loads of kinds of fan and pump PD119 can be set to 120. When the current of the inverter is greater than 120% the output frequency will decrease and the current will also decrease accordingly. After the current returns to normal the frequency will return to normal slowly, so as to achieve the stall prevention function. The decreasing speed of the frequency is determined by PD119. For the Related parameters refer to PD 119.

PD122 Stall Prevention Level at Deceleration		
Set Range: 0-200%	Unit: 1	Factory Setting: 150

Refer to Pd120.

100% current is the rated current of the motor.

PD123 Over-torque Detect Mode		
Set Range: 0-3	Unit: 1	Factory Setting: 0

- 0: When reaching the frequency it starts to detect over-torque and when over-torque is detected it continues to run.
- 1: When reaching the frequency it starts to detect over-torque and when over-torque is detected it stop running.
- 2: It detects over-torque during running and when over-torque is detected it continues to run.
- 3: It detects over-torque during running and when over-torque is detected it stop running.

PD124 Over-torque Detect Level		
Set Range: 0-200%	Unit: 1%	Factory Setting: 0

When the output current exceeds the over-torque detection level and also exceeds half of the set time of over-torque detection (factory setting: 1.0s), the over-torque detection will indicate, and the corresponding multi-function alarm contact will act. When it exceeds the set time, the inverter will turn to self-protection. When this parameter is set to 0, the over-torque detection will be invalid

PD125 Over-torque Detect Time		
Set Range: 0.1-20.0s	Unit: 0.1s	Factory Setting: 1.0

When the inverter detects that the output current has exceeded the motor current set value, the inverter begins to calculate the over-torque time. When the over-torque time has exceeded half of the set detect time, the corresponding multi-function output contact will act, and produce the over-torque alarm, while the inverter will keep running. When the over-torque time has exceeded the set detect time (set by PD125), the inverter will turn to self-protection, display the fault information and stop output.

For the related parameters refer to Pd123.

PD126 Counter Memory		
Set Range: 0-1	Unit: 0	Factory Setting: 0

- 0: Not memorized
- 1: Memorized

The function of counter memory, the function of inverter power-breakdown memory

PD127PD129 Reserved

PD130 Number of Auxillary Pump		
Set Range: 0-2	Unit: 1	Factory Setting: 0

This parameter is set for the number of auxiliary pump. The start or stop of the auxiliary pumps is controlled by using the multi-output contacts and Auxiliary Pump 1 or Auxiliary Pump 2 is controlled through the peripheral control circuit.

PD131 Continuous Running Time of Auxillary Pumps		
Set Range: 19000 (min)	Unit: 1	Factory Setting: 60

In case of two pumps with only one pump in duty, in order to ensure each pump to work evenly, it will be switched to another pump when its running time reaches the set value of PD131.

PD132 Interlocking Time of Auxillary Pump		
Set Range: 1-250S	Unit: 1	Factory Setting: 5S

This parameter is set to determine the interlocking time of two auxiliary pumps when switching with each other.

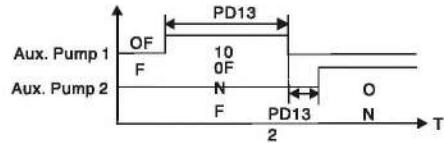

PD133 High Speed Running Time
Set Range: 1-250S Unit: 1 Factory Setting: 60S

In the application of water supply with constant pressure, when the master pump is running at the frequency of high speed (set by PD060) due to larger water volume and the high speed running time is reached, the corresponding multi-function contacts act and the auxiliary pumps start.

PD134 Low Speed Running Time
Set Range: 1-250S Unit: 1 Factory Setting: 60S

In the application of water supply with constant pressure, when the master pump is running at the frequency of low speed (set by PD061) due to smaller water volume and the low speed running time (PD134) is reached, the corresponding multi-function contacts act and the auxiliary pumps stop.

PD133 and PD134 must be used in combination of PD060, PD061 and multi-outputs. Their main function is to increase or decrease the number of auxiliary pump.

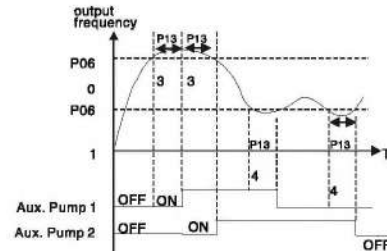

PD135 Stopping Voltage Level
Set Range: 0-150% Unit: 1 Factory Setting: 95%

This parameter is set for the voltage level of the master pump entering into sleep mode. For details refer to the following description.

PD136 Lasting Time of Stopping Voltage Level
Set Range: 1-250S Unit: 1 Factory Setting: 30S

This parameter is set for the lasting time under the stopping voltage level before entering into sleep mode. For details refer to the following description.

PD137 Wakeup Voltage Level
Set Range: 1-150% Unit: 1 Factory Setting: 80%

This parameter is set for the wakeup voltage level from sleep to wakeup.

PD138 Sleep Frequency
Set Range: 0.00-400.0 Unit: 1 Factory Setting: 20.00

PD139 Lasting Time of Sleep Frequency
Set Range: 1-250S Unit: 1 Factory Setting: 20S

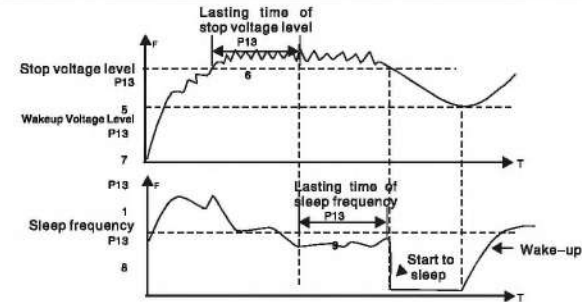

This parameter is set for the lasting time to run at sleep frequency when entering into sleep mode.

PD140 Reserved

PD141 Rated Motor Voltage	Unit: 0.1V	Factory Setting: *
----------------------------------	------------	--------------------

It is set according to the rated voltage value of the nameplate of the motor. For the inverters of 230V class the factory setting is 220, while for the inverters of 400 V class the factory setting is 380.

PD142 Rated Motor Current	Unit: 0.1A	Factory Setting: *
----------------------------------	------------	--------------------

It is set according to the rated value of the nameplate of the motor. This parameter can be used to restrict the output current of the inverter to prevent over-current and protect the motor. If the current of the motor has exceeded this value the inverter of AC motor will turn to self-protection.

PD143 Motor Pole Number
Set Range: 02-10 Unit: 1 Factory Setting: 04

This parameter is set for the number of the motor's pole according to the nameplate of the motor.

PD144 Rated Motor Revolution
Set Range: 0-9999 Unit: 1r/min Factory Setting: 1440

This is set according to the actual revolution of the motor. The displayed value is the same as this set value. It can be used as a monitoring parameter, which is convenient to the user. This set value corresponds to the revolution at 50Hz.

PD145 Auto Torque Compensation
Set Range: 0.1-10.0 % Unit: 0.1% Factory Setting: 2.0%

This parameter can be set for the auto output of extra voltage when the inverter is running to achieve higher torque, which can compensate for the under-torque at lower frequency. The torque compensation should not be too big and it should be set slowly from low to high according to the actual situation.

Insufficient compensation will result in the under-torque of the motor at lower frequency. And over compensation will lead to too bigger torque, which will produce a shock to the machine and even result in a trip of the inverter under serious situation.

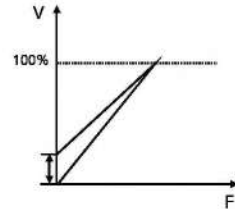

PD146 Motor No-load Current
Set Range: 0-99 Unit: 1 Factory Setting: 40

The setting of motor no-load current will affect the value of slip compensation. The current is 100% of the rated current of the motor.

PD147 Motor Slip Compensation
Set Range: 0.0-10.0 Unit: 0.1 Factory Setting: 20

When the inverter drives the motor the slip becomes bigger due to the increase of load. This parameter can be set for slip compensation to decrease the slip and make the running speed of the motor closer to the synchronous revolution.

PD148-PD149 Reserved

PD150 Auto Voltage Regulation
Set Range: 0-1 Unit: 1 Factory Setting: 1

0: Invalid
1: Valid

When the input power is not stable and if the voltage is too high the operation of the motor with the power exceeding the rated voltage will cause increase of the temperature of the motor, damage of its insulation and unstable output torque. This auto voltage regulation can automatically stabilize the output voltage within the rated voltage range of the motor under the condition of unstable output power supply. When this function is set to invalid the output voltage will fluctuate.

PD151 Auto Energy Saving
Set Range: 0-10% Unit: 1% Factory Setting: 0

When it is set to zero this function is invalid. When Auto energy saving function is started the inverter will run at the full voltage during ramp-up or -down. During the operation at constant speed the inverter can automatically calculate the optimum voltage value according to the power of load and supply power to the load to achieve the goal of energy saving.

PD152 Fault Restart Time	Factory Setting: 1.0 s
---------------------------------	------------------------

When the inverter is set for fault restart and if it has a fault trip with the time exceeding the set value of Pd152 the inverter will restart. When using this function pay more attention to the safety.

PD153 Restart after Instantaneous Stop
Set Range: 0-1 Unit: 1 Factory Setting: 0

0: Invalid, i.e. the inverter will not restart after an instantaneous power breakdown.
1: Start by frequency track. Refer to PD025.

PD154 Allowable Power-Breakdown Time
Set Range: 0.1-5.0S Unit: 0.1S Factory Setting: 0.5

This parameter is set for the maximum allowable power failure time. If exceeding the set time the inverter will continue to stop output after power on. To restart the inverter it needs to follow the general starting procedures.

PD155 Number of Abnormal Restart
Set Range: 00-10 Unit: 1 Factory Setting: 00

After the abnormal conditions (such as over-current and over-voltage) happens the inverter will automatically reset and restart. If the starting mode is set to normal mode it will start according to the normal procedures. If it is set to start by frequency track it will start in the frequency track mode. After starting it will restore the set number again if there is no more abnormality happened within 60 seconds. If there is still any error and it reaches the set number the inverter will stop output. It can only be started after reset. When PD155 is set to zero the inverter will not carry out the functions of automatic reset and restart.

PD156 Proportional Constant (P)	**
Set Range: 0.0-1000.0% Unit: 0.1% Factory Setting: 100%	

This proportional constant is set for the error value gain. In case of I=0, D=0, it is only for proportional control.

PD157 Integral Time (I)	**
Set Range: 0.1-3600.0s Unit: 0.1s Factory Setting: 5.0s	

The integral time (I) is set for the responding speed for PID. The larger the I value is set the slower the responding speed will be. To the contrary, if the responding speed is quick but the integral time value is set too small, it will cause oscillation.

PD158 Differential Time (D)	**
Set Range: 0.01-10.00s Unit: 0.01s Factory Setting: 0	

This differential time (D) is set for the depression operation of PID. The larger the D value is, the more obvious the depression operation will be. When D is set to zero, this function is invalid.

PD159 Target Value	**
Set Range: 0-100.0% Unit: 1% Factory Setting: *	

This target value can be set through external voltage signal or the digital operator. 100% target value is corresponding to the analog frequency at +10V.

PID closed-loop control is usually used in the process control with physical quantity not changing fast, such as the controls of pressure and temperature, etc. The feedback signal is usually taken from temperature transmitter, or pressure transmitter, etc. Under PID control, the feedback signal input path is the analog current signal of 4-20mA.

PID closed-loop control is valid when Multi-input PID is started.

PID Control Block Diagram:

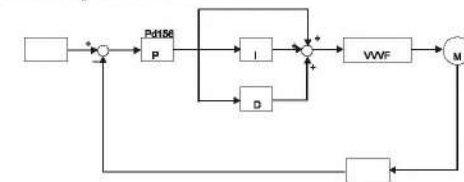



General operating methods of PID control:

- (1) Choose the correct transmitter (with the output specification of standard current signal 4-20mA).
- (2) Set the right target value.
- (3) If the output does not have oscillation, increase the proportional constant (P).
- (4) If the output does not have oscillation, decrease the integral time (Ti).
- (5) If the output do not have oscillation, increase the differential time (Td).
- (6) Concrete applications can be referred to the example application descriptions in Appendix 1.

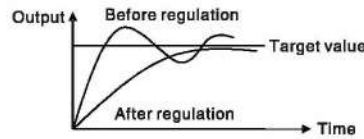

1. Suppress the Over Output
a: Decrease the differential time (Dvalue)
b: Increase the integral time (I value)

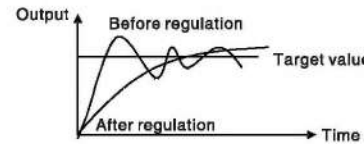

2. Suppress the oscillation
a: Decrease the differential time (D value) or set it to zero.
b: Decrease Proportional Constant (P value)

PD160	PID Target Value	**
Set Range:	0-1	Unit: Factory Setting: 0

The target value can be set through the selection of the panel or external analog. The external analog is 0-10V signal or given by the potentiometer.

When PD160=0, the target value of PID is the value set by PD159.

When PD160=1, the target value of PID is the value of the external analog 0-10V (corresponding to 0-100%), the setting of PD159 is invalid.

PD161	PID Upper Limit	**
Set Range:	0-100%	Unit: Factory Setting: 100%

When PID feedback value is more than the set value of PD161 the corresponding multi-output will act and the inverter will not stop.

PD162	PID Lower Limit	**
Set Range:	0-100%	Unit: Factory Setting: 0%

When PID feedback value is less than the set value of PD162 the corresponding multi-output will act and the inverter will not stop.

PD163	Communication Addresses	**
Set Range:	00-250	Unit: Factory Setting: 00

When the inverter is set for RS-485 Communication interface control, each of the inverters will be set for its individual identification .

- 00: No communication function.
- 01-250: Address for the inverters

PD164	Communication Baud Rate	**
Set Range:	0-3	Unit: Factory Setting: 0

0: 4800 b/s 1: 9600 b/s 2: 19200 b/s 3: 34800 b/s

PD165	Communication Data Method	**
Set Range:	0-5	Unit: 1 Factory Setting: 0

0: 8N1 For ASCII 1: 8E1 For ASCII 2: 8O1 For ASCII
3: 8N1 For RTU 4: 8E1 For RTU 5: 8O1 For RTU

PD166-PD168	Reserved	**
-------------	----------	----

PD170	Display Items	**
Set Range:	0-5	Unit: 1 Factory Setting: 7

This parameter is only valid when Bit 2 is set to 1 in PD171. For the details refer to PD171.

- 0: Inverter Temperature
- 1: Counter Value
- 2: PID Target Value
- 3: PID Feedback Value

PD171	Display Items Open	**
Set Range:	0-15	Unit: 1 Factory Setting: 7

This parameter is set for selection of displaying of DC voltage, AC voltage and other items so that the customer can monitor and view them in sequence through the switch key.

It can be is set first in the binary 3 bits mode, and then converted to a decimal value.

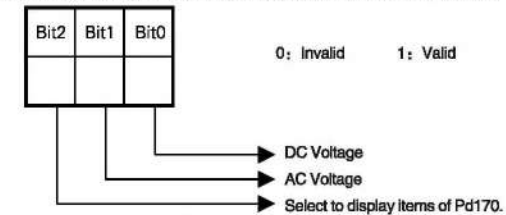

In the contents displayed the factory setting is to show output frequency, set frequency, output current and output revolution through the switch key. If it is necessary to view and monitor other items they can be set through PD170 and Pd171.

PD172	Fault Clear	**
Set Range:	00-10	Unit: 1 Factory Setting: **

01 is for fault clear. Others have no function.

PD173	Voltage Rating of Inverter	**
Set Range:	00-10	Unit: 1V Factory Setting: **

It is factory setting. It is depending on the model .It can be observed, but not set.



PD174	Rated Current of Inverter	Unit: 1A	Factory Setting: *
-------	---------------------------	----------	--------------------

It is depending on the model and can't be changed.

PD175	Inverter Model		
Set Range:	01	Unit: 1	Factory Setting: 0

0: Constant torque 1: For kinds of fan. It can be observed, but not changed.

PD176	Inverter Frequency Standard	Unit: 1	Factory Setting: *
-------	-----------------------------	---------	--------------------

0: 50Hz 1: 60Hz It is factory setting. It can be observed, but not set.

PD177	Fault Record 1	Factory Setting:
PD178	Fault Record 2	Factory Setting:
PD179	Fault Record 3	Factory Setting:
PD180	Fault Record 4	Factory Setting:

When it has no fault record it shows . After access to this parameter the fault display can be checked.

PD181	Software Version	Factory Setting: *
-------	------------------	--------------------

It can be observed, but not set.

PD182	Manufacture date	Factory Setting: *
-------	------------------	--------------------

It is factory setting. It can be observed, but not set.

PD183	Serial No.	Factory Setting: *
-------	------------	--------------------

It is factory setting. It can be observed, but not set.

PD183~PD250	Factory Setting: *
-------------	--------------------

Note:

* means the said parameter has a variety of set values or should be set specifically according to concrete conditions.

** means the said parameter can be set during the operation.

X. Care & Maintenance, Fault Information and Troubleshooting

Periodical maintenances and inspections will keep your inverter in its normal state for long time.

1. Precautions about Inspection and Maintenance

- Be sure to turn off the power supply to the inverter (R.S.T) first before the inspection and maintenance.
- After confirming the main circuit power supply has been turned off and the display has disappeared, wait until the internal indicator lamp for high voltage goes out before performing the inspection and maintenance.
- During the inspection, do not pull out or wrongly distribute the internal power supply, wires and cables. Otherwise it will cause malfunction or damage to the inverter.
- Do not leave any screw or other part inside the inverter during the installation, or it will result in the short circuit of circuit board.
- Keep the inverter clean, free from dust, oil mist and moisture after the installation.

2. Periodical Inspection and Maintenance Items

- Check whether the power supply voltage conforms to the rated voltage of the inverter. (Pay special attention to that whether there is any damage on the power supply wires and the motor.)
- Check whether the wiring terminals and the connectors are tight (Check whether the power supply wires and terminal connection wires have any broken strand).
- Check whether there is dust, iron filings or corrosive fluid in the inverter. Measuring the insulation impedance of the inverter is forbidden.
- Examine the output voltage, output current and output frequency of the inverter. (The measuring results should not have too big difference.)
- Check whether the ambient temperature of the inverter is between -5°C and 40°C and whether the installation environment has good ventilation.
- Check whether the humidity is kept below 90% (without condensation).
- Check whether the motor makes unusual noises or abnormal vibration in running. (The inverter should not be installed in a place with high vibration.)
- Please make periodical cleaning of vent holes.

3. Fault Indication and Troubleshooting

The inverter of HLP series is relatively perfective with the protection functions of overload, inter-phase short circuit, earth short circuit, under-voltage, overheating and over-current, etc. When a protection function happens with the inverter please check the reasons of faults according to the information listed in the table below. The inverter can be restarted after the disposal. If the fault cannot be disposed please contact the local distributor.

Fault Display	Fault Contents & Description	Disposal methods
OC-I	Over-current during ramp-up	1: Check whether the motor has got short circuit or partial short circuit and whether the insulation of output wire is good. 2: Extend the ramp-up time. 3: The configuration of the inverter is not reasonable. The inverter's capacity should be increased. 4: Decrease the torque and increase the set value.



OC-1	Over-current at constant speed	<ol style="list-style-type: none"> 1: Check whether the motor has got short circuit and whether the insulation of the output wires is good. 2: Check whether the motor is blocked and whether there is a sudden change of mechanical load. 3: Check whether the inverter's capacity is too small and increase its capacity. 4: Check whether there is a sudden change in the power supply voltage.
OC-2	Over-current at decel Over-current at stop	<ol style="list-style-type: none"> 1: Check whether the insulation of the output wires is good and whether the motor has got short circuit. 2: Extend the Ramp-down Time. 3: Replace it with an inverter of larger capacity. 4: DC braking is too high. Decrease DC braking. 5: The inverter has failure. Please send it to the factory for repair.
OL	Output short circuit	<ol style="list-style-type: none"> 1: Check whether the connection wire of the motor has got short circuit. 2: Check whether the insulation of the output wires is good. 3: Please send it for repair.
OU-1 OU-2	Over-voltage at stop Over-voltage at accel Over-voltage at constant speed Over-voltage at decel	<ol style="list-style-type: none"> 1: Extend the Ramp-down Time or add a braking resistor. 2: Improve the mains supply voltage and check whether there is any sudden change in the voltage.
Fb	Fuse break	Fuse break. Please send it to the factory for repair.
LV	Low voltage	<ol style="list-style-type: none"> 1: Check whether the input voltage is normal. 2: Check whether there is sudden change in load. 3: Check whether there is any phase missing.

OH	Overheat of inverter	<ol style="list-style-type: none"> 1: Check whether the fan is blocked and whether there is any foreign matter stuck in the cooling fins. 2: Check whether the ambient temperature is normal. 3: Check whether there is enough space for ventilation and good air convection.
OL-1	Inverter overload 150% Per minute	<ol style="list-style-type: none"> 1: Check whether the capacity of the inverter is lower. Otherwise it should be increased. 2: Check whether there is any jamming in the mechanical load. 3: The setting of V/F curve is bad. Set it again.
OL-2	Motor overload 150% Per minute	<ol style="list-style-type: none"> 1: Check whether there is any sudden change in the mechanical load. 2: The equipped motor is too small. 3: The motor is hot and the insulation becomes bad. 4: Check whether the voltage has big fluctuation. 5: Check whether there is any phase missing. 6: The mechanical load is increased.
OT	Motor over-torque	<ol style="list-style-type: none"> 1: Check whether there is any fluctuation in the mechanical load. 2: Check whether the equipped motor is smaller.
E.b5.A E.b5.n E.b5.d E.b5.S	No feedback from auxiliary coil of the electromagnetic contactor	Please contact the factory.
bt	Braking transistor damage	Please send it for repair.
CPU	CPU fault	Please contact the factory.
E.E.E.S E.E.E.n E.E.E.d E.E.E.A	E ² Prom fault	Please contact the factory.



Er	External interferences	Isolate the interference source
ES	Emergency Stop	In Emergency Stop
20	4-20mA wire broken	Join the broken wires
Pr	Setting error	Correct the setting
Dcb	DC braking status	In DC braking

Note:

(1) Fault Code Form as follows:

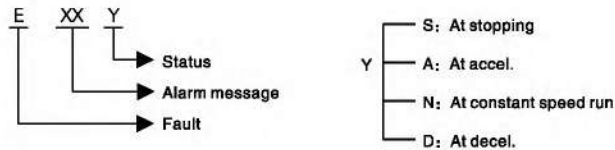

(2) Code Comparison Table

	B	C	D	E	F	G	H	O	S	N	L	T	P	R	U	2
	b	c	d	e	f	g	h	o	s	n	l	t	p	r	u	2

4. Faults and Analysis

- (1) When RUN key is pressed, the motor does not run.
- The setting of operation mode is wrong, i.e., under the operation mode of external control terminals, the inverter is started by the digital operator or under the operation mode of the digital operator it is started by the external control terminals.
 - The frequency reference is too low or not set.
 - The peripheral wiring is wrong. For example, the setting of wiring of two-wire system and three-wire system and other related parameters have errors.
 - The setting of multi-function terminals is wrong (in the external control).
 - The inverter is in the fault protection.
 - The motor fails.
 - The inverter fails.
- (2) The parameters cannot be set.
- Password locks. Please decrypt it first before resetting.
 - The inverter is in running.
 - The connection of the connecting parts is abnormal. The communication of the digital operator is abnormal. Take out the operator after power-off and then mount it again for a trial.

(3) The motor cannot rotate reverse.

Reverse rotation is disabled.

(4) The motor rotates in the opposite direction.

The output line is wrongly connected. Please change any two lines of U.V.W over.

(5) The deceleration of the motor is too slow.

- The setting of Ramp-down Time is too long. Decrease Ramp-down Time.
- Add a braking resistor.
- Add a DC brake.

(6) Over-heat of the motor

- The load is too large. The actual torque has exceeded the rated torque of the motor. It is recommended to increase the capacity of the motor.
- The ambient temperature is too high. In a place with higher temperature the motor will be burn out. Please decrease the temperature around the motor.
- The phase withstand voltage of the motor is insufficient.
The switch actions of the inverter will make the winding coil of the motor produce shock wave. Typically the maximum shock voltage will reach 3 times that of input power of the inverter. Please select a motor with higher phase to phase withstand voltage against shock than the maximum shock voltage.

(7) The starting of the inverter interferes other control devices

- Decrease the carrier frequency and reduce the number of actions of internal switches.
- Install a noise filter at the power input of the inverter.
- Install a noise filter at the output of the inverter.
- Make correct grounding for the inverter and the motor.
- Use metal conduit to tube the cable to shield it.
- Make separate wiring for the main circuit wires and control wires.

(8) When the fan starts the inverter detected an over-current stall.

- At start the fan rotates idly. Please set it for DC braking at start.
- When DC braking at start has been set increase the DC braking value.

(9) The machine has the noise of vibration or roar

- The vibration frequency of mechanical system resonates with the carrier. Adjust the carrier to avoid the point of resonance.
- The vibration frequency of mechanical system resonates with the output frequency of the inverter.
A. Set it for skip function to avoid the point of resonance.
B. Put rubber vibration isolator on the base plate of motor.

XI. Selection of Peripheral Devices and Disposition

1. Options

Description	Functions
NFB or Ground fault interrupter for wire connection	Protect the wiring of the inverter. Be sure to install a breaker at the power. Please select a ground fault circuit interrupter against high-order harmonics.
Electromagnetic contactor	In order to prevent the braking resistor from burning out, please add an electromagnetic contactor and connect a surge absorber to the coil when using it.



Surge absorber	Absorb the switching surge current from the electromagnetic contactor and control relays.
Isolating transformer	Its function of isolating the input and output of the inverter is effective to reduce the interference to other electric devices.
DC reactor	Improve the input power factor of the inverter.
AC reactor	Improve the input power factor of the inverter and prevent the shock of surge voltage.
Braking resistor, braking unit	Consume the regenerating energy of the motor and shorten the ramp-down time.

1) Leakage switch

There is earth static capacity inside of the inverter and the motor as well as the input and output leads. Due to higher carrier frequency of the inverter the inverter has higher earth leakage current, especially for the inverters of large capacity series. When using a leakage switch it may sometimes result in the error action of the protective circuit. So when using a leakage switch attention should be paid to its selection and the proper reduction of carrier frequency and shortening the leads, etc.

2) AC reactors

An AC reactor can constrict the high-order harmonic of input current of the inverter to improve its input power factor and prevent the shock of surge. It is recommended to use an input AC reactor under the following circumstances:

- a: Three-phase power supply is in unbalance.
- b: Any equipment with thyristor or power factor compensation unit with switching control is connected to the same power supply.

3) DC reactors

It is necessary to install a DC reactor when the capacity of power supply is more than 1000 KVA or the mains power capacity is higher than the rated capacity of the inverter. A DC reactor is also needed for the case with higher demand on the improvement of power factor of power supply. This DC reactor can be used together with an AC reactor to achieve the obvious effect of decreasing high-order harmonic at input. If it is necessary to install a DC reactor please contact the local distributor.

Disposition of Braking Resistor

Inverter Model	Braking resistor Specification		Braking torque 10%ED	Special Motor KW
	W	Ω		
HY00D423B	80	200	125	0.4
HY0D7523B	100	200	125	0.75
HY01D523B	300	100	125	1.5
HY02D223B	300	70	125	2.2
HY0D7543B	80	750	125	0.75
HY01D543B	300	400	125	1.5
HY02D243B	300	250	125	2.2

HY03D743B	400	150	125	3.7
HY05D543B	500	100	125	5.5
HY07D543B	1000	75	125	7.5
HY11D043B	1000	50	125	11
HY15D043B	1500	40	125	15
HY18D543B	4800	32	125	18.5
HY22D043B	4800	27.2	125	22
HY30D043B	6000	20	125	30
HY37D043B	9600	16	125	37
HY45D043B	9600	13.6	125	45
HY55D043B	12000	20/2	125	55
HY75D043B	18000	13.6/2	125	75
HY90D043B	18000	20/3	125	90
HY110D043B	18000	20/3	125	110
HY132D043B	24000	20/4	125	132
HY160D043B	36000	13.6/4	125	160
HY200D043B	45000	13.6/5	125	200
HY220D043B	48000	13.6/5	125	220
HY315D043B	57600	13.6/6	125	300

For the inverter of above 11KW to realize quick brake a braking unit must be added.

Note:

- 1: Please select the resistor value and operating frequency given by our company.
- 2: If it causes any damage to the inverter and other devices due to the use of any braking resistor and braking model group not supplied by our company, we will take no responsibility.
- 3: Be sure to consider the safety and ignitability of the environment when installing a braking resistor. The distance to the inverter should be at least 100 mm.
- 4: If it is necessary to change the resistor value and power value, please contact the local distributor.
- 5: In need of a braking resistor a separate order must be placed. Please contact the local distributor for details.