

User Manual

Hybrid 5.5KW PV Inverter

Version: 1.0

Table of Contents

1. Introduction.....	1
2. Important Safety Warning.....	2
3. Unpacking & Overview.....	4
4. Installation	5
5. Surge Protection Device Installation	6
6. Grid (Utility) Connection	7
7. PV Module (DC) Connection	8
8. Battery Connection.....	11
9. Load (AC Output) Connection	12
10. Communication	14
11. Application with Energy Meter.....	15
12. Commissioning.....	16
13. Initial Setup	17
14. Operation	27
15. Charging Management.....	38
16. Maintenance & Cleaning	40
17. Trouble Shooting	41
18. Specifications	44

1. Introduction

This hybrid PV inverter can provide power to connected loads by utilizing PV power, utility power and battery power.

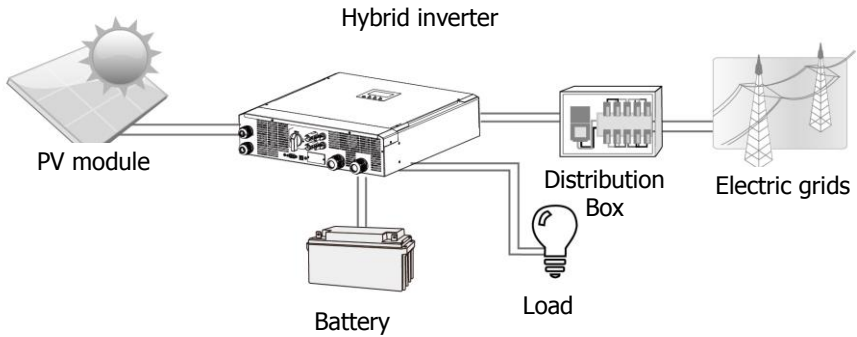

Figure 1 Basic hybrid PV System Overview

Depending on different power situations, this hybrid inverter is designed to generate continuous power from PV solar modules (solar panels), battery, and the utility. When MPP input voltage of PV modules is within acceptable range (see specification for the details), this inverter is able to generate power to feed the grid (utility) and charge battery. This inverter is only compatible with PV module types of single crystalline and poly crystalline. Do not connect any PV array types other than these two types of PV modules to the inverter. Do not connect the positive or negative terminal of the solar panel to the ground. See Figure 1 for a simple diagram of a typical solar system with this hybrid inverter.

Note: To conform to the EEG standard, every inverter sold to German area is not allowed to charge battery from Utility. The relevant function is automatically disabled via the software.

2. Important Safety Warning

Before using the inverter, please read all instructions and cautionary markings on the unit and this manual. Store the manual where it can be accessed easily.

This manual is for qualified personnel. The tasks described in this manual may be performed by qualified personnel only.

General Precaution-

Conventions used:

WARNING! Warnings identify conditions or practices that could result in personal injury;
CAUTION! Caution identify conditions or practices that could result in damage to the unit or other equipment connected.



WARNING! Before installing and using this inverter, read all instructions and cautionary markings on the inverter and all appropriate sections of this guide.



WARNING! Normally grounded conductors may be ungrounded and energized when a ground fault is indicated.



WARNING! This inverter is so heavy that it should be lifted by at least two persons.



CAUTION! Before attempting any maintenance or cleaning or working on any circuits connected to the inverter, disconnecting AC, DC and battery power from the inverter can reduce the risk of electric shock. Merely turning off controls will not reduce this risk because internal capacitors can remain charged for 5 minutes after disconnecting all sources of power.



CAUTION! Do not disassemble this inverter by yourself. It contains no user-serviceable parts. Attempt to service this inverter by yourself may cause electric shock or fire and will void the warranty from the manufacturer.



CAUTION! To avoid fire and electric shock, make sure that existing wiring is in good condition and that the wire is not undersized. Do not operate the damaged Inverter or substandard wiring.



CAUTION! In high temperature environment, the surface of this inverter could be hot enough to cause skin burns if accidentally touched. Ensure that this inverter is away from normal traffic areas.



CAUTION! Use only recommended accessories from installer. Otherwise, disqualified tools may cause fire, electric shock, or injury to persons.



CAUTION! To reduce risk of fire hazard, do not cover or obstruct the cooling fan.



CAUTION! Do not operate the Inverter if it has undergone a sharp blow, been dropped, or damaged in any way. If the Inverter is damaged, please call for an RMA (Return Material Authorization) request.



CAUTION! AC breaker, DC switch and Battery circuit breaker are used as disconnect devices and these disconnect devices shall be easily accessible.

Before working on this circuit	
<ul style="list-style-type: none"> - Isolate inverter/Uninterruptible Power System (UPS) - Then check for Hazardous Voltage between all terminals including the protective earth. 	
	Risk of Voltage Backfeed

Symbols used in Equipment Markings

	Refer to the operating instructions
	Caution! Risk of danger
	Caution! Risk of electric shock
	Caution! Risk of electric shock. Energy storage timed discharge for 5 minutes.
	Caution! Hot surface

3. Unpacking & Overview

3-1. Packing List

Before installation, please inspect the unit. Be sure that nothing inside the package is damaged. You should receive the following items inside of package:



3-2. Product Overview

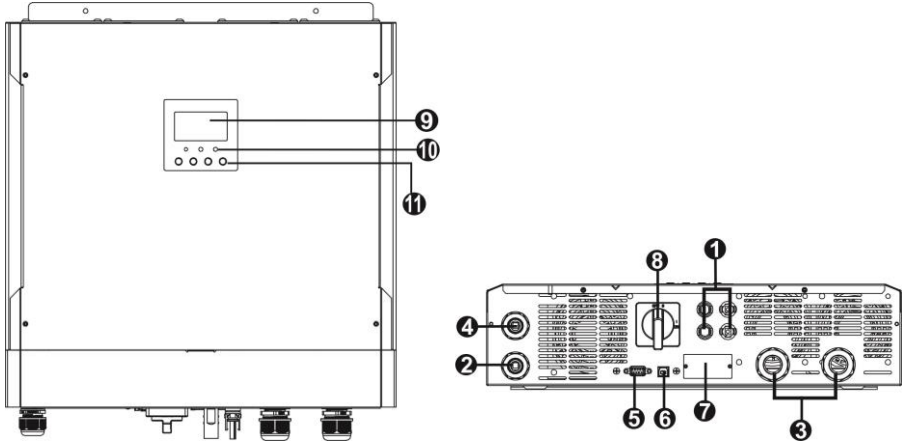

- 1) PV connectors
 - 2) AC output connectors (Load connection)
 - 3) Battery connectors
 - 4) AC Grid connectors (Connect to SPD)
 - 5) RS-232 communication port
 - 6) USB communication port
 - 7) Intelligent slot
 - 8) DC Switch (option)
 - 9) LCD display panel
 - 10) LED indicators
 - 11) Operation buttons
- (Please check section 14 for details about LCD display, LED indicators and button operation)

4. Installation

4-1. Selecting Mounting Location

Consider the following points to install the inverter:

- Do not mount the inverter on flammable construction materials.
- Mount on a solid surface
- This inverter might make noises during operation which may be perceived as a nuisance in a living area.
- Install this inverter at eye level in order to allow the readability of LCD display at all times.
- For proper air circulation to dissipate heat, allow a clearance of approx. 20 cm to the side and approx. 50 cm above and below the unit.
- Dusty conditions on the unit may impair the performance of this inverter.
- The ambient temperature should be between 0°C and 40°C and relative humidity should be between 5% and 85% to ensure optimal operation.
- The recommended installation is vertical adherence.
- For proper operation of this inverter, please use appropriate cables for grid connection.
- The pollution degree of the inverter is PD2. Select an appropriate mounting location. Install the solar inverter in a protected area that is dry, free of excessive dust and with adequate air flow. Do NOT operate it in the place where the temperature and humidity is beyond the specific limits. (Please check the specs for the limitations.)
- The inverter should be installed in the position where the disconnection means is easily accessible.
- This inverter is designed with IP20 protection for indoor applications only.
- Regularly clean the fan filter.

4-2. Mounting Unit

WARNING!! Remember that this inverter is heavy so please be careful when removing it from the package.

Installation to the wall should be fixed with proper screws. After that, the device should be bolted on securely.

The inverter can only operate in a CLOSED ELECTRICAL OPERATING AREA. Only service personnel can enter this area.

WARNING!! FIRE HAZARD.
SUITABLE FOR MOUNTING ON CONCRETE OR OTHER NON-COMBUSTIBLE SURFACE ONLY.

Fix the unit with four screws.

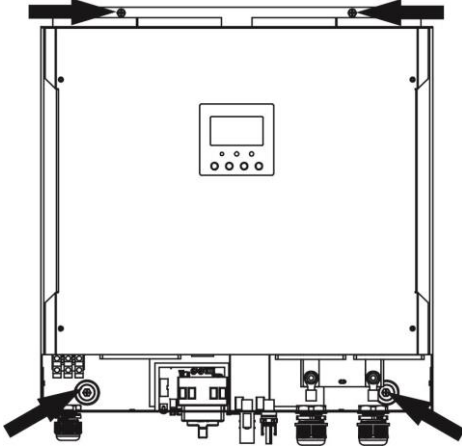

5. Surge Protection Device Installation

CAUTION: Be sure to disconnect from AC power before installing surge protection device.

Step 1: Install the SPD on the left hand side of the inverter with six magnets.

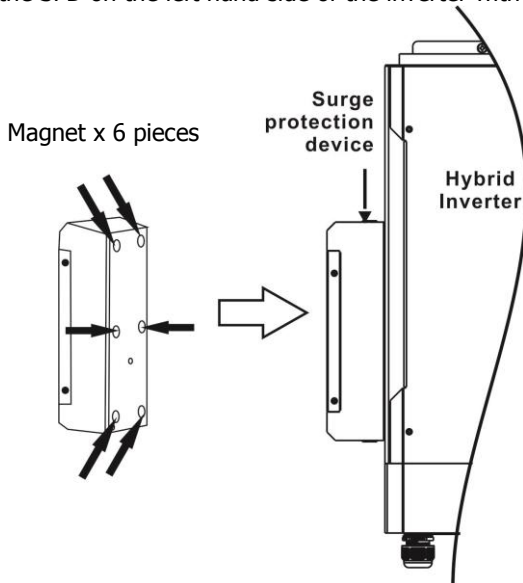

Step 2: To prevent surge protection device falling apart, use supplied L-type plate and fix it to attach surge protection device tightly to the inverter.

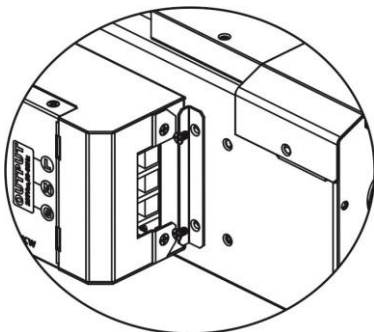

Step 3: Connect the OUTPUT of SPD to AC grid connectors of Hybrid Inverter. The INPUT of SPD is connected to AC utility.

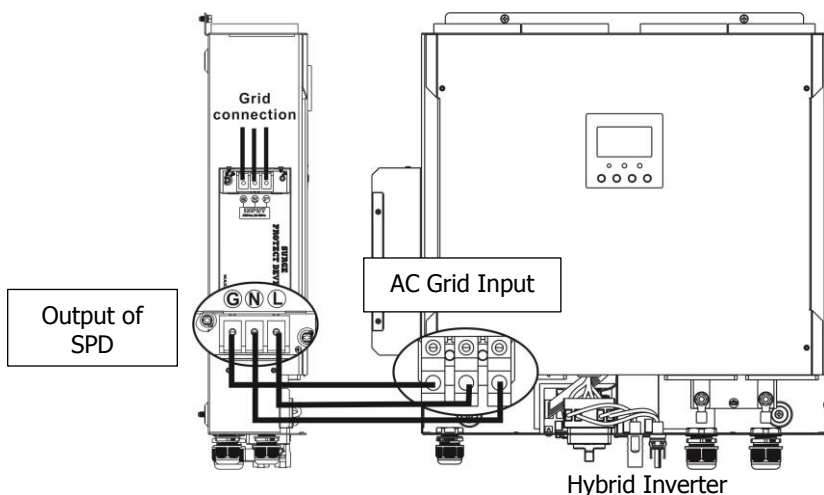

6. Grid (Utility) Connection

6-1. Preparation

Before connecting to AC utility, please install a **separate** AC circuit breaker between surge protection device (SPD) and AC utility. This will ensure the inverter can be securely disconnected during maintenance and fully protected from over current of AC input.

NOTE1: Although this inverter is equipped with 250VAC/40A fuse, it's still necessary to install a separate circuit breaker for safety consideration. Please use 250VAC/40A circuit breaker between surge protection device (SPD) and AC utility.

NOTE2: The overvoltage category of the AC input is III. It should be connected to the power distribution.

WARNING! For safety and efficiency, it's very important to use appropriate cables for grid (utility) connection. To reduce risk of injury, please use the proper cable size recommended below.

Suggested cable requirement for AC wire

Model	5.5KW
Nominal Grid Voltage	230VAC
Conductor cross-section (mm ²)	6
AWG no.	10

6-2. Connecting to the AC Utility

Step 1: Check the grid voltage and frequency with an AC voltmeter to see if it's same as the "VAC" value on the product label.

Step 2: Turn off the circuit breaker.

Step 3: Remove insulation sleeve 10 mm from three conductors and shorten phase L and neutral conductor N for 3 mm. Refer to chart 1.

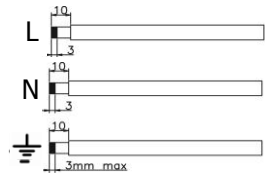

Chart 1

Step 4: Connect wires according to the polarities indicating on terminal block. Be sure to connect PE protective conductor (**G**) first.

L → **LINE (brown or black)**

N → **Neutral (blue or white)**

G → **Ground (yellow-green)**

Step 5: Make sure the wires are securely connected. The reference tightening torque is 1.4~1.6N.m.

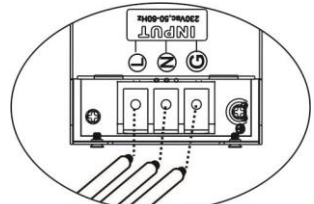

Chart 2

7. PV Module (DC) Connection

CAUTION: Before connecting to PV modules, please install **separately** DC circuit breakers between inverter and PV modules.

NOTE1: Please use 600VDC/30A circuit breaker.

NOTE2: The overvoltage category of the PV input is II.

Please follow the steps below to implement PV module connection:

WARNING: Because this inverter is non-isolated, only three types of PV modules are acceptable: single crystalline and poly crystalline with class A-rated and CIGS modules.

To avoid any malfunction, do not connect any PV modules with possible current leakage to the inverter. For example, grounded PV modules will cause current leakage to the inverter. When using CIGS modules, please be sure NO grounding.

CAUTION: It's requested to use PV junction box with surge protection. Otherwise, it will cause damage on inverter when lightning occurs on PV modules.





Step 1: Check the input voltage of PV array modules. The acceptable input voltage of the inverter is 250VDC-450VDC (with rated load). This system is applied with two strings of PV array. Please make sure that the maximum current load of each PV input connector is 13A.

CAUTION: Exceeding the maximum input voltage can destroy the unit!! Check the system before wire connection.

Step 2: Disconnect the circuit breaker and switch off the DC switch.

Step 3: Assemble provided PV connectors with PV modules by the following steps.

Components for PV connectors and Tools:

Female connector housing	
Female terminal	
Male connector housing	
Male terminal	
Crimping tool and spanner	

Prepare the cable and follow the connector assembly

process:

Strip one cable 8 mm on both end sides and be careful NOT to nick conductors.

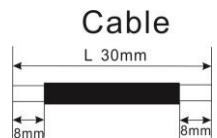

Insert striped cable into female terminal and crimp female terminal as shown below.



Insert assembled cable into female connector housing as shown below.

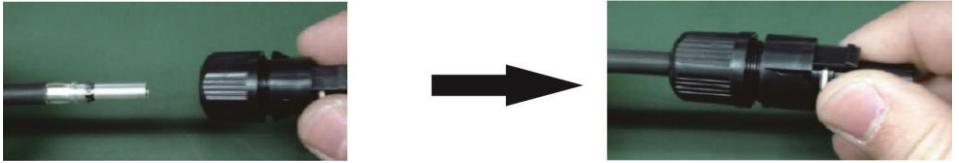

Insert striped cable into male terminal and crimp male terminal as shown below.



Insert assembled cable into male connector housing as shown below.

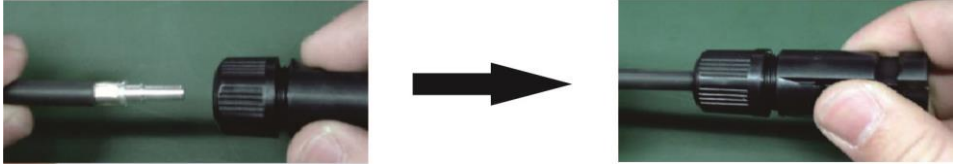

Then, use spanner to screw pressure dome tightly to female connector and male connector as shown below.



Step 4: Check the correctness of the polarity of connection cable on PV modules and PV input connectors. Then, connect positive pole (+) of connection cable to positive pole (+) of PV input connector. Connect negative pole (-) of connection cable to negative pole (-) of PV input connector.

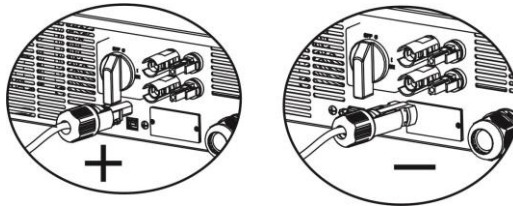

WARNING! For safety and efficiency, it's very important to use appropriate cables for PV module connection. To reduce risk of injury, please use the proper cable size as recommended below.

Conductor cross-section (mm ²)	AWG no.
4~6	10~12

CAUTION: Never directly touch the terminals of inverter. It might cause lethal electric shock.

Recommended Panel Configuration

CAUTION: Do NOT touch the inverter to avoid electric shock. When PV modules are exposed to sunlight, it may generate DC voltage in the inverter.

Solar Panel Spec. (reference)	SOLAR INPUT 1	SOLAR INPUT 2	Q'ty of panels	Total Input Power
	(Min in serial: 6pcs; Max. in serial: 12pcs)			
- 260Wp - Vmp: 30.7Vdc - Imp: 9.18A - Voc: 38.9Vdc - Isc: 8.56A - Cells: 60	6pcs in serial	x	6pcs	1560W
	x	6pcs in serial	6pcs	1560W
	8pcs in serial	x	8pcs	2080W
	x	8pcs in serial	8pcs	2080W
	6pcs in serial	6pcs in serial	12pcs	3120W
	7pcs in serial	7pcs in serial	14pcs	3640W
	8pcs in serial	8pcs in serial	16pcs	4160W
	10pcs in serial	10pcs in serial	20pcs	5200W
	12pcs in serial	12pcs in serial	24pcs	6240W

8. Battery Connection

CAUTION: Before connecting to batteries, please **separately** install a DC circuit breaker between inverter and batteries.

NOTE1: Please only use sealed lead acid battery, vented and Gel battery. Please check its maximum charging voltage and current when first using this inverter. If using Lithium iron or Nicd battery, please consult with installer for the details.

NOTE2: Please use 80VDC/200A circuit breaker.

NOTE3: The overvoltage category of the battery input is II. Please follow the steps below to implement battery connection:

Step 1: Check the nominal voltage of batteries. The nominal input voltage for inverter is 48VDC.

Step 2: Use two battery cables. Remove insulation sleeve 12 mm and insert conductor into cable ring terminal. Refer to the right diagram.

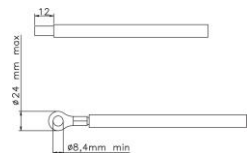

Step 3: Remove the cover of battery and follow the polarity of battery printed near the battery terminal! Place the external battery cable ring terminal over the battery terminal.

RED cable to the positive terminal (+);

BLACK cable to the negative terminal (-).

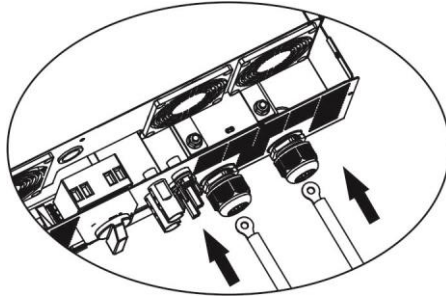

WARNING! Wrong connections may damage the unit permanently.

Step 4: Make sure the wires are securely connected. The reference tightening torque is 2.04 N.m.

WARNING! For safety and efficiency, it's very important to use appropriate cables for battery connection. To reduce risk of injury, please use the proper cable size recommended as below.

Conductor cross-section (mm ²)	38
AWG no.	2

9. Load (AC Output) Connection

CAUTION: To prevent extra supply to the load via the inverter during any mode of operation, an additional disconnection device should be placed on in the building wiring installation.

WARNING! For safety and efficiency, it's very important to use appropriate cable for AC connection. To reduce risk of injury, please use the proper cable size recommended as below.

Model	5.5KW
Nominal Grid Voltage	230VAC
Conductor cross-section (mm ²)	6
AWG no.	10

Step 1: Remove insulation sleeve 8 mm for three conductors. And shorten phase L and neutral conductor N 3 mm. Refer to Diagram 3.

Step 2: Connect wires according to the polarities indicated on terminal block. Be sure to connect PE protective conductor (⏏) first. Refer to Diagram 4.

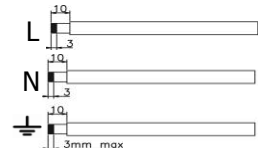

Diagram 3

L→**LINE (brown or black)**

→**Ground (yellow-green)**

N→**Neutral (blue or white)**

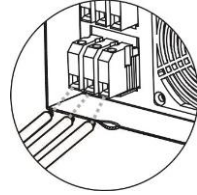

Diagram 4

Step 3: Make sure the wires are securely connected.
The reference tightening torque is 1.4~1.6N.m.

CAUTION: It's only allowed to connect load to "AC Output Connector". Do NOT connect the utility to "AC Output Connector".

CAUTION: Be sure to connect L terminal of load to L terminal of "AC Output Connector" and N terminal of load to N terminal of "AC Output Connector". The G terminal of "AC Output Connector" is connected to grounding of the load. Do NOT mis-connect.

CAUTION: This inverter is not allowed to operate in parallel. Please do NOT connect more than one unit in parallel in AC output connector. Otherwise, it will damage this inverter.

10. Communication

The inverter is equipped with RS232 port, USB port and a slot for alternative communication interfaces in order to communicate with a PC via corresponding software. This intelligent slot is suitable to install with SNMP card and Modbus card. Follow the procedure below to connect communication wiring and install the software.

For RS232 port, you should use a DB9 cable as below:

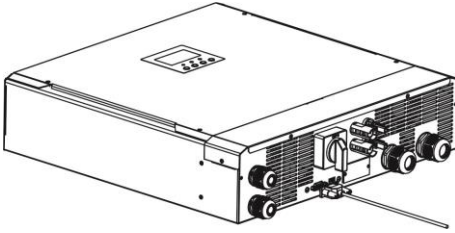

For USB port, you should use a USB cable as below:

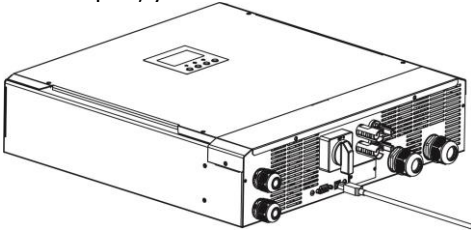

For SNMP or MODBUS card, you should use RJ45 cables as below:

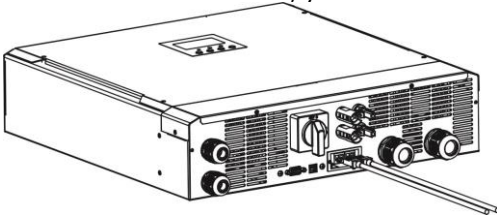

Please install monitoring software in your computer. Detailed information is listed in next chapter. After software is installed, you may initialize the monitoring software and extract data through communication port.

11. Application with Energy Meter

With Modbus card II and energy meter, hybrid inverter can be easily integrated into the existing household system. For details please refer to Modbus card II manual.

Note: This application is only valid for **Grid-Tie with Backup II** mode.

Equipped with Modbus card II, hybrid inverter is connected to energy meter with RS485 communication port. It's used to set up self-consumption function via Modbus card to control power generation and battery charging of the inverter.

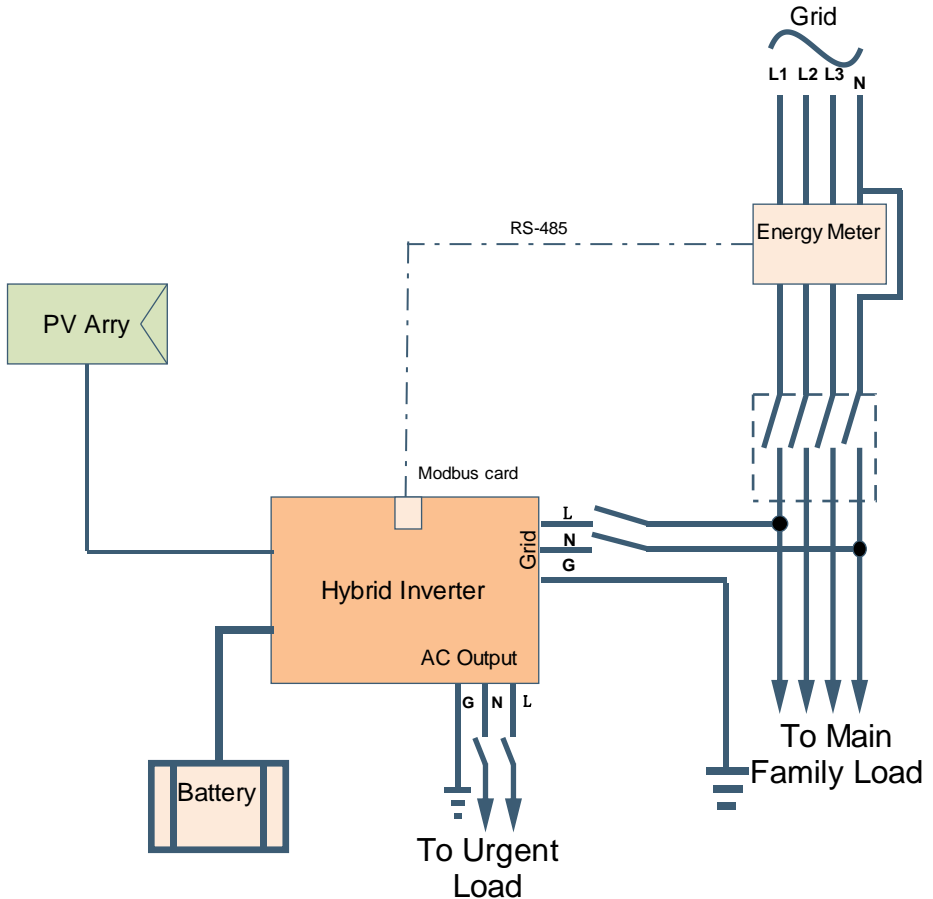

12. Commissioning

Step 1: Check the following requirements before commissioning:

- Ensure the inverter is firmly secured
- Check if the open circuit DC voltage of PV module meets the requirement (Refer to Section 6)
- Check if the voltage of the open circuit utility is approximately as same as the expected nominal value from local utility company.
- Check if connection of AC cable to grid (utility) is correct if the utility is required.
- Fully connect to PV modules.
- Check if AC circuit breaker (only applied when the utility is required), battery circuit breaker, and DC circuit breaker are installed correctly.

Step 2: Switch on the circuit breaker of battery and then switch on PV DC breaker. After that, if there is any connection with utility, please switch on the AC circuit breaker. At this moment, the inverter is already turned on. However, there is no output generation from loads. Then:

- If LCD lights up to display the status of current inverter, commissioning has been completed successfully. After pressing "ON" button for 1 second when the utility is detected, this inverter will start to supply power to the loads. If no utility exists, simply press "ON" button for 3 seconds. Then, this inverter will start to supply power to the loads.
- If an error occurs to this inverter, a warning/fault indicator will appear on LCD display. Please inform your installer.

Step 3: Please insert CD into your computer and install monitoring software on your PC. Follow the steps below to install the software.

1. Follow the on-screen instructions to install the software.
2. When your computer restarts, the monitoring software will appear as shortcut icon located in the system tray, near the clock.

NOTE: If using modbus card as communication interface, please install bundled software. Check local dealer for the details.

13. Initial Setup

Before inverter starts to operate, it's required to set up "Operation Mode" via software. Please strictly follow the steps below to set up. For more details, please refer to software manual.

Step 1: After turning on the inverter and installing the software, please click "Open Monitor" to enter main screen of this software.

Step 2: Log in the software first by entering the default password "administrator."

Step 3: Select Device Control>>MyPower Management to set up inverter operation mode and personalized interface. Refer to diagram below.

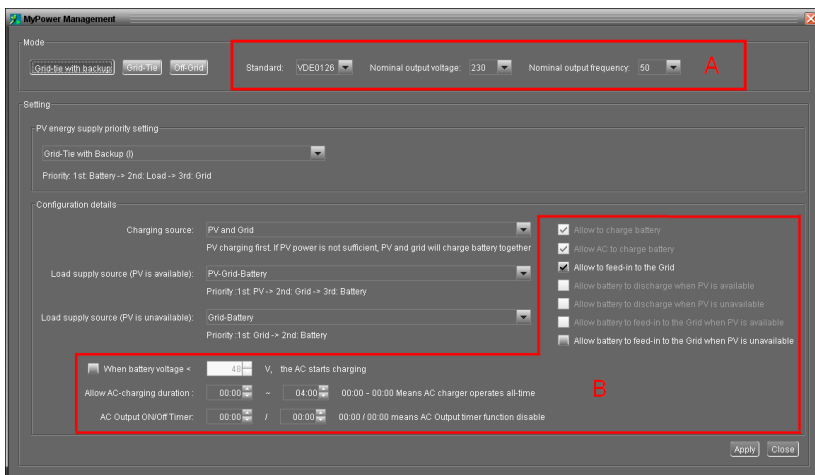
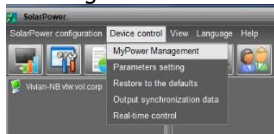

Mode

There are three operation modes: Grid-tie with backup, Grid-Tie and Off-Grid.

- Grid-tie with backup: PV power can feed back to grid, provide power to the load and charge battery. There are four options available in this mode: Grid-tie with backup I, II, III and IV. In this mode, users can configure *PV power supply priority, charging source priority and load supply source priority*. However, when Grid-tie with backup IV option is selected in PV energy supply priority, the inverter is only operating between two working logics based on defined peak time and off-peak time of electricity. Only peak time and off-peak time of electricity are able to set up to optimize electricity usage.
- Grid-Tie: PV power can only feed back to grid.
- Off-Grid: PV power can only provide power to the load and charge battery but can't feed back to grid.

SECTION A:

Standard: It will list local grid standard. To make any modification, you're requested to have factory password. Please check local dealer only when this standard change is

requested.

CAUTION: Wrong setting could cause damage to the unit or not working.

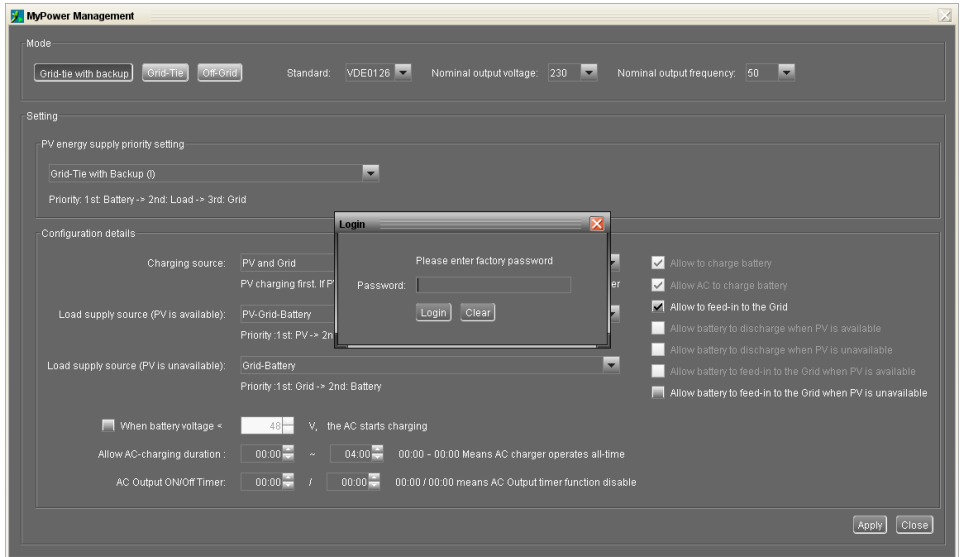

Nominal Output Voltage: 230V.

Nominal Output Frequency: 50HZ.

SECTION B:

This section contents may be different based on different selection of operations.

Allow AC charging duration: It's a period of time to allow AC (grid) to charge battery. When the duration is set as 0:00-00:00, it means no time limitation for AC to charge battery.

AC output ON/Off Timer: Set up on/off time for AC output of inverter. If setting it as 00:00/00:00, this function is disabled.

Allow to charge battery: This option is automatically determined by setting in "Charging source". It's not allowed to modify here. When "NONE" is selected in charging source section, this option becomes unchecked in grey text.

Allow AC to charge battery: This option is automatically determined by setting in "Charging source". It's not allowed to modify here. When "Grid and PV" or "Grid or PV" is selected in charging source section, this option is default selected. In Grid-tie mode, this option is invalid.

Allow to feed-in to the Grid: This option is only valid under Grid-tie and Grid-tie with backup modes. Users can decide if this inverter can feed-in to the grid.

Allow battery to discharge when PV is available: This option is automatically determined by setting in "Load supply source (PV is available)". When "Battery" is higher in priority than "Grid" in Load supply source (PV is available), this option is selected in default. Under Grid-tie, this option is invalid.

Allow battery to discharge when PV is unavailable: This option is automatically determined by setting in "Load supply source (PV is unavailable)". When "Battery" is higher in priority than "Grid" in Load supply source (PV is unavailable), this option is selected in default. In Grid-tie mode, this option is invalid.

Allow battery to feed-in to the Grid when PV is available: This option is only valid in Grid-tie with backup II or Grid-tie with backup III modes.

Allow battery to feed-in to the Grid when PV is unavailable: This option is only valid in all options of Grid-tie with backup mode.

Grid-tie with backup

Grid-tie with backup (I):

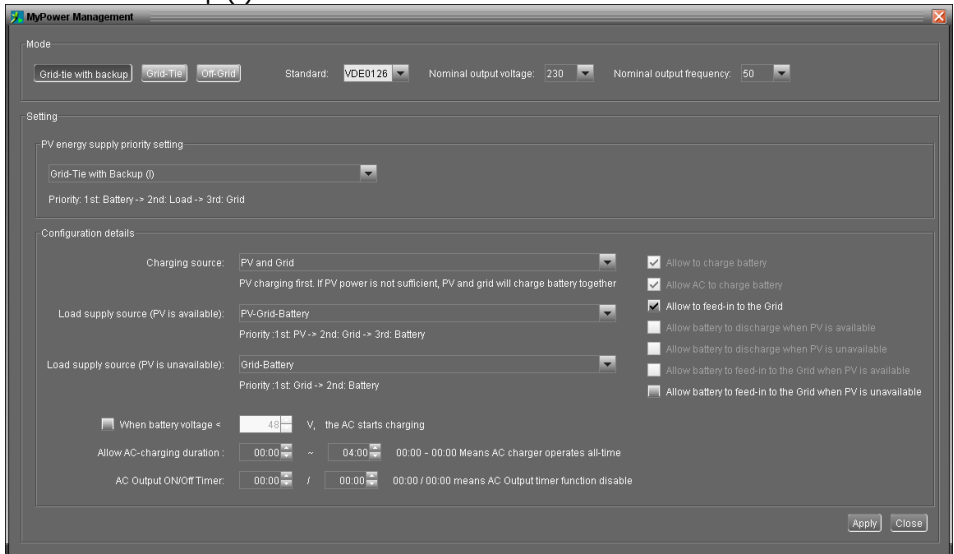

PV energy supply priority setting: 1st Battery, 2nd Load and 3rd Grid.

PV power will charge battery first, then provide power to the load. If there is any remaining power left, it will feed-in to the grid.

Battery charging source:

1. PV and Grid (Default)

It's allowed to charge battery from PV power first. If it's not sufficient, grid will charge battery.

2. PV only

It is only allow PV power to charge battery.

3. None

It is not allowed to charge battery no matter it's from PV power or grid.

Load supply source:

When PV power is available: 1st PV, 2nd Grid, 3rd Battery

If battery is not fully charged, PV power will charge battery first. And remaining PV

power will provide power to the load. If it's not sufficient, grid will provide power to the load. If grid is not available at the same time, battery power will back up.

When PV power is not available:

1. 1st Grid, 2nd Battery (Default)

Grid will provide power to the load first. If grid is not available, battery power will provide power backup.

2. 1st Battery, 2nd Grid

Battery power will provide power to the load first. If battery power is running out, grid will back up the load.

NOTE: This option will become ineffective during AC charging time and the priority will automatically become 1st Grid and 2nd Battery order. Otherwise, it will cause battery damage.

Grid-tie with backup (II):

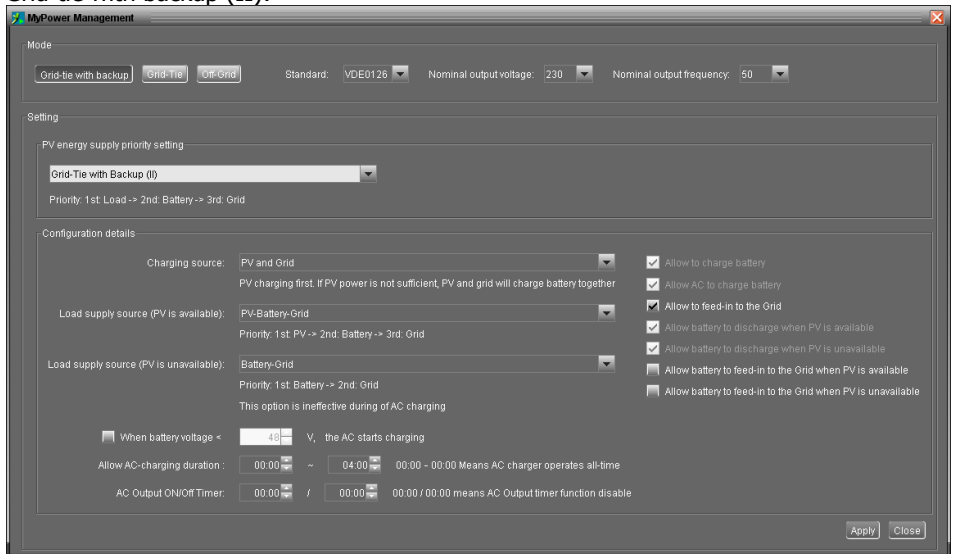

PV energy supply priority setting: 1st Load, 2nd Battery and 3rd Grid.

PV power will provide power to the load first. Then, it will charge battery. If there is any remaining power left, it will feed-in to the grid.

Battery charging source:

1. PV and Grid

It's allowed to charge battery from PV power first. If it's not sufficient, grid will charge battery.

2. PV only

Only PV power is allowed to charge battery.

3. None

It is not allowed to charge battery no matter it's PV power or grid.

Load supply source:

When PV power is available:

1. 1st PV, 2nd Battery, 3rd Grid

PV power will provide power to the load first. If it's not sufficient, battery will provide power to the load. When battery is running out power or not available, grid will back up the load.

2. 1st PV, 2nd Grid, 3rd Battery

PV power will provide power to the load first. If it's not sufficient, grid will provide power to the load. If grid is not available at the same time, battery power will back up the load.

When PV power is not available:

1. 1st Grid, 2nd Battery: Grid will provide power to the load first. If grid is not available, battery will provide power backup.
2. 1st Battery, 2nd Grid: Battery will provide power to the load first. If battery is running out power, grid will back up the load.

NOTE: This option will become ineffective during AC charging time and the priority will automatically become 1st Grid and 2nd Battery order. Same as Grid-tie with backup (I).

Grid-tie with backup (III):

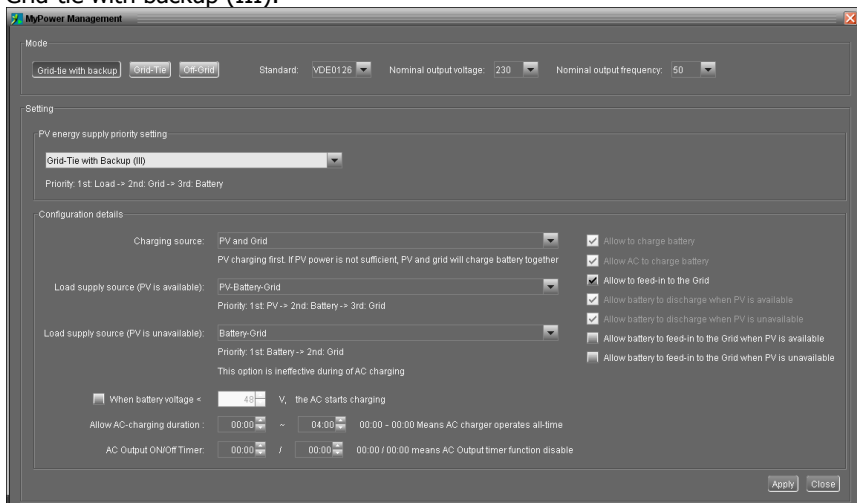

PV energy supply priority setting: 1st Load, 2nd Grid and 3rd Battery

PV power will provide power to the load first. If there is more PV power available, it will feed-in to the grid. If feed-in power reaches the max. feed-in power setting, the remaining power will charge battery.

NOTE: The max. feed-in grid power setting is available in parameter setting. Please refer to software manual.

Battery charging source:

1. PV and Grid: It's allowed to charge battery from PV power first. If it's not sufficient, grid will charge battery.

2. PV only: PV power is only allowed to charge battery.
3. None: It is not allowed to charge battery no matter it's PV power or grid.

Load supply source:

When PV power is available:

1. 1st PV, 2nd Battery, 3rd Grid

PV power will provide power to the load first. If it's not sufficient, battery power will provide power to the load. When battery power is running out or not available, grid will back up the load.

2. 1st PV, 2nd Grid, 3rd Battery

PV power will provide power to the load first. If it's not sufficient, grid will provide power to the load. If grid is not available at the same time, battery power will back up the load.

When PV power is not available:

1. 1st Grid, 2nd Battery: Grid will provide power to the load first. If grid is not available, battery power will provide power backup.

2. 1st Battery, 2nd Grid: Battery power will provide power to the load first. If battery power is running out, grid will back up the load.

NOTE: This option will become ineffective during AC charging time and the priority will automatically become 1st Grid and 2nd Battery order. Same as Grid-tie with backup (I).

Grid-tie with backup (IV):

Users are only allowed to set up peak time and off-peak electricity demand.

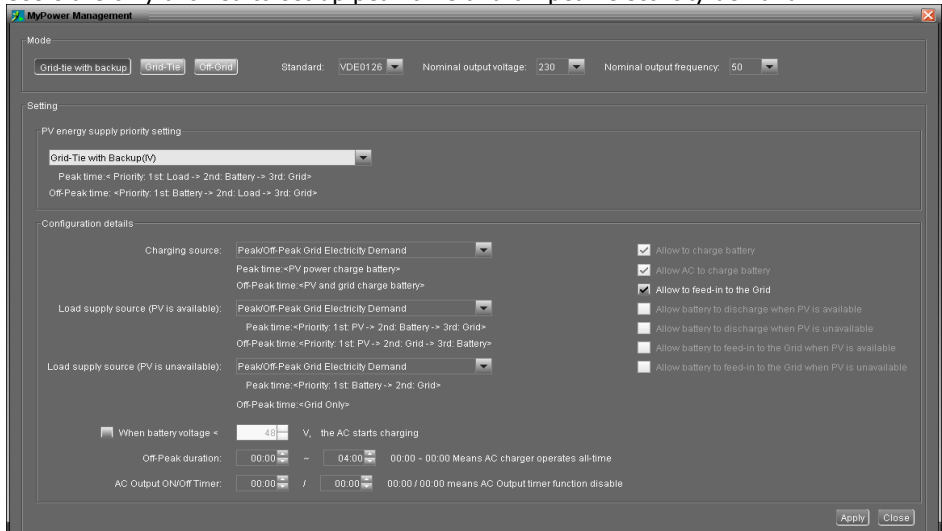

Working logic under peak time:

PV energy supply priority: 1st Load, 2nd Battery and 3rd Grid

PV power will provide power to the load first. If PV power is sufficient, it will charge battery next. If there is remaining PV power left, it will feed-in to the grid. Feed-in to the grid is disabled in default.

Battery charging source: PV only

Only after PV power fully supports the load, the remaining PV power is allowed to charge battery during peak time.

Load supply source: 1st PV, 2nd Battery, 3rd Grid

PV power will provide power to the load first. If PV power is not sufficient, battery power will back up the load. If battery power is not available, grid will provide the load. When PV power is not available, battery power will supply the load first. If battery power is running out, grid will back up the load.

Working logic under off-peak time:

PV energy supply priority: 1st Battery, 2nd Load and 3rd Grid

PV power will charge battery first. If PV power is sufficient, it will provide power to the loads. The remaining PV power will feed to the grid.

NOTE: The max. feed-in grid power setting is available in parameter setting. Please refer to software manual.

Battery charging source: PV and grid charge battery

PV power will charge battery first during off-peak time. If it's not sufficient, grid will charge battery.

Load supply source: 1st PV, 2nd Grid, 3rd Battery

When battery is fully charged, remaining PV power will provide power to the load first. If PV power is not sufficient, grid will back up the load. If grid power is not available, battery power will provide power to the load.

Grid-Tie

In this operation mode, PV power only feeds in to the grid. No priority setting is available.

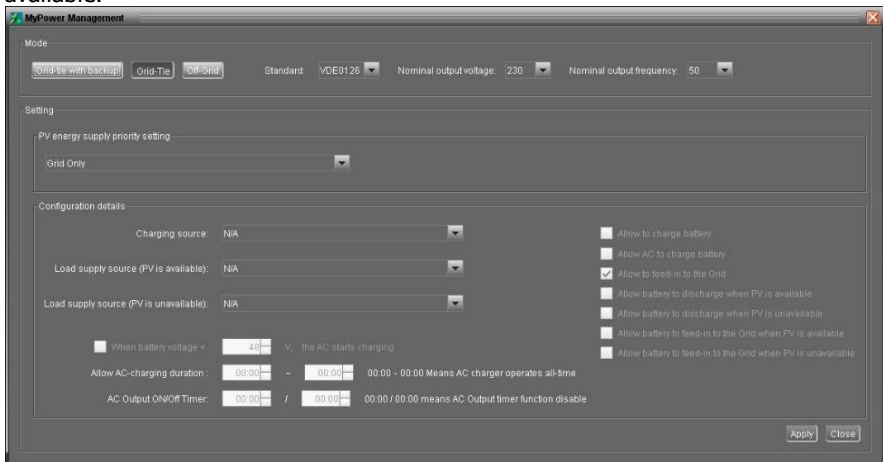

Off-Grid

● Off-Grid (I): Default setting for off-grid mode.

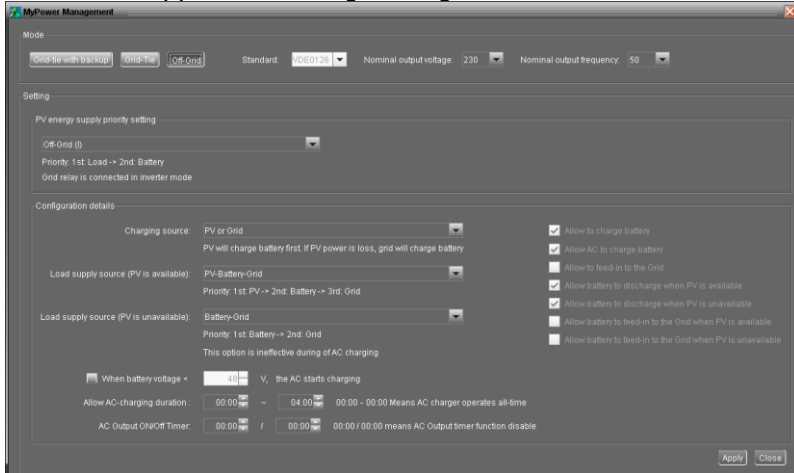

PV energy supply priority setting: 1st Load, 2nd Battery

PV power will provide power to the load first and then charge battery. Feed-in to the grid is not allowed in this mode. At the same time, the grid relay is connected in Inverter mode. That means the transfer time from inverter mode to battery mode will be less than 15ms. Besides, it will avoid overload fault because grid can supply load when connected load is over 5KW.

Battery charging source:

1. PV or Grid: If there is remaining PV power after supporting the loads, it will charge battery first. Only until PV power is not available, grid will charge battery. (Default)
2. PV only: It is only allow PV power to charge battery.
3. None: It is not allowed to charge battery no matter it's PV power or grid.

Load supply source:

When PV power is available:

1. 1st PV, 2nd Battery, 3rd Grid (Default)

PV power will provide power to the load first. If it's not sufficient, battery power will provide power to the load. When battery power is running out or not available, grid will back up the load.

2. 1st PV, 2nd Grid, 3rd Battery

PV power will provide power to the load first. If it's not sufficient, grid will provide power to the load. If grid is not available at the same time, battery power will back up.

When PV power is not available:

1. 1st Grid, 2nd Battery

Grid will provide power to the load first. If grid is not available, battery power will provide power backup.

2. 1st Battery, 2nd Grid (Default)

Battery power will provide power to the load first. If battery power is running out, grid will back up the load.

NOTE: This option will become ineffective during AC charging time and the priority will automatically become 1st Grid and 2nd Battery order. Otherwise, it will cause battery damage.

● **Off-Grid (II)**

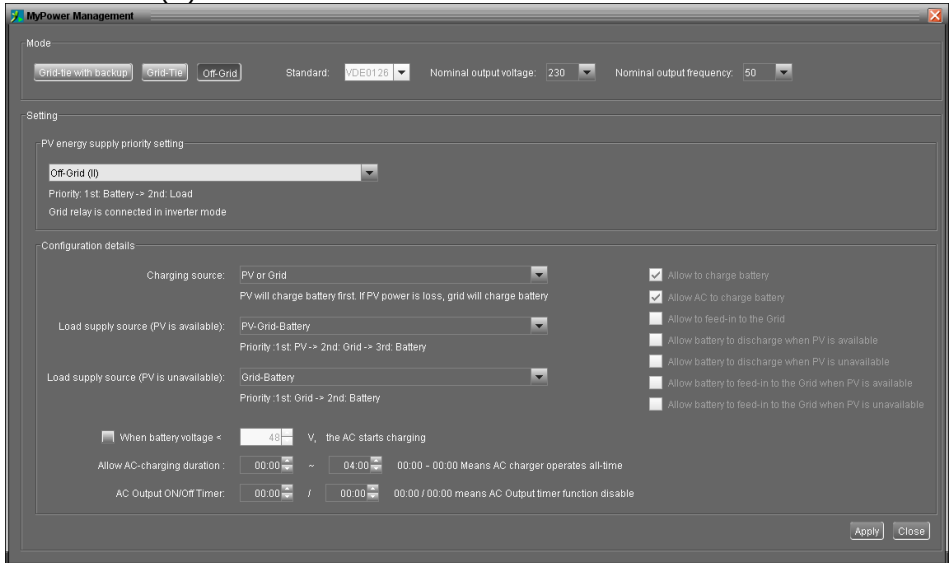

PV energy supply priority setting: 1st Battery, 2nd Load

PV power will charge battery first. After battery is fully charged, if there is remaining PV power left, it will provide power to the load. Feed-in to the grid is not allowed under this mode. At the same time, the grid relay is connected in Inverter mode. That means the transfer time from inverter mode to battery mode will be less than 15ms. Besides, it will avoid overload fault because grid can supply load when connected load is over 5KW.

Battery charging source:

1. PV or Grid: If there is remaining PV power after supporting the loads, it will charge battery first. Only until PV power is not available, grid will charge battery.
2. PV only: It is only allow PV power to charge battery.
3. None: It is not allowed to charge battery no matter it's PV power or grid.

NOTE: It's allowed to set up AC charging duration.

Load supply source:

When PV power is available: 1st PV, 2nd Grid, 3rd Battery

PV power will provide power to the load first. If it's not sufficient, grid will provide power to the load. If grid is not available at the same time, battery power will back up the load.

When PV power is not available:

1. 1st Grid, 2nd Battery: Grid will provide power to the load first. If grid is not available, battery power will provide power backup.

2. 1st Battery, 2nd Grid: Battery power will provide power to the load first. If battery power is running out, grid will back up the load.

NOTE: This option will become ineffective during AC charging time and the priority will automatically become 1st Grid and 2nd Battery order. Otherwise, it will cause battery damage.

● Off-Grid (III)

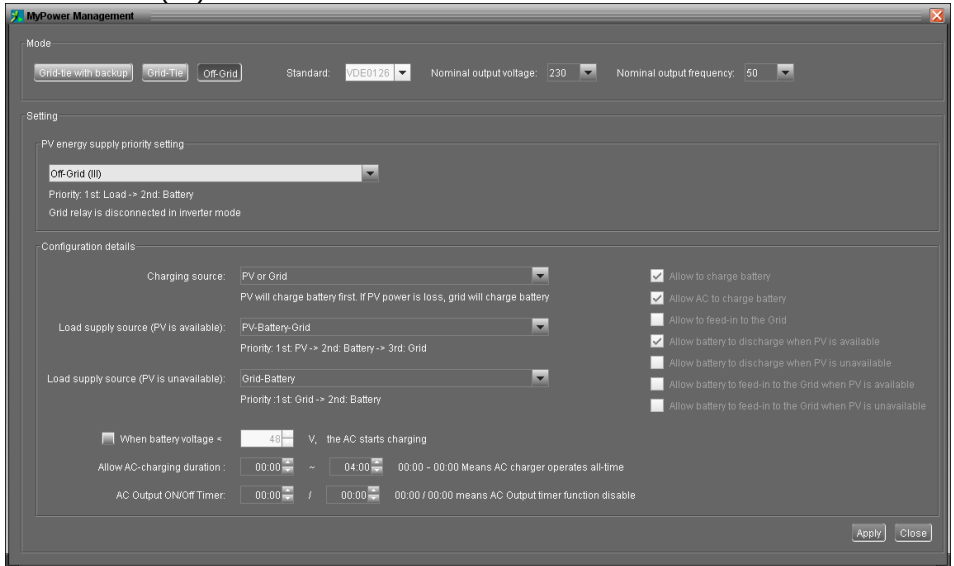

PV energy supply priority setting: 1st Load, 2nd Battery

PV power will provide power to load first and then charge battery. Feed-in to the grid is not allowed in this mode. The grid relay is NOT connected in Inverter mode. That means the transfer time from inverter mode to battery mode will be about 15ms. If connected load is over 5KW and grid is available, this inverter will allow grid to provide power to the loads and PV power to charge battery. Otherwise, this inverter will activate fault protection.

Battery charging source:

1. PV or Grid: If there is remaining PV power after supporting the loads, it will charge battery first. Only until PV power is not available, grid will charge battery.
2. PV only: PV power is only allowed to charge battery.
3. None: It is not allowed to charge battery no matter it's PV power or grid.

NOTE: It's allowed to set up AC charging duration.

Load supply source:

When PV power is available: 1st PV, 2nd Battery, 3rd Grid

PV power will provide power to the load first. If it's not sufficient, battery power will back up the load. Only after battery power is running out, Grid will back up the load.

When PV power is not available:

- 1st Grid, 2nd Battery: Grid will provide power to the load first. If grid is not available, battery power will provide power backup.
- 1st Battery, 2nd Grid: Battery power will provide power to the load first. If battery power is running out, grid will back up the load.

NOTE: This option will become ineffective during AC charging time and the priority will automatically become 1st Grid and 2nd Battery order. Otherwise, it will cause battery damage.



14. Operation

Operation and Display Panel

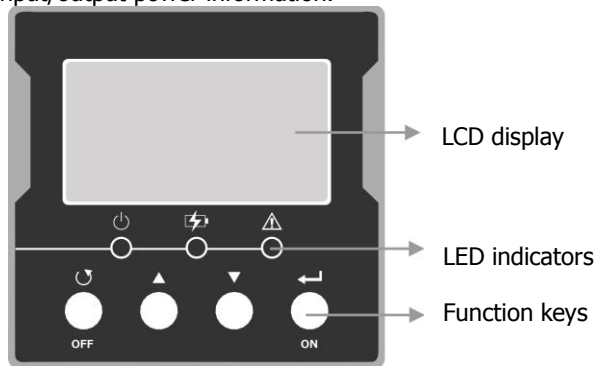



The operation and display panel, shown in the diagram below, is on the front panel of the inverter. It includes three indicators, four function keys and a LCD display, indicating the operating status and input/output power information.



LED Indicator

LED Indicator		Messages	
	Green	Solid On	Output is powered by utility in Line mode.
		Flashing	Output is powered by battery or PV in battery mode.
	Yellow	Solid On	Battery is fully charged.
		Flashing	Battery is charging.
	Red	Solid On	Fault occurs in the inverter.
		Flashing	Warning condition occurs in the inverter.



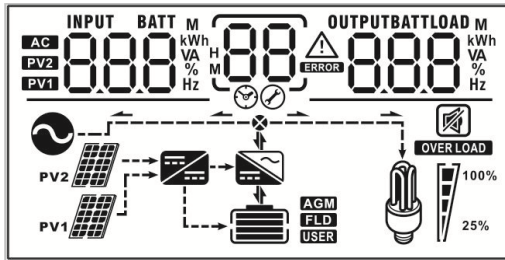

Function Keys

Function Key	Description
 /OFF	To exit setting mode
	<ul style="list-style-type: none"> To go to previous selection or decrease value in setting mode Enter setting mode
	<ul style="list-style-type: none"> To go to next selection or increase value in setting mode Enter setting mode
 /ON	To confirm the selection in setting mode or turn on AC output

LCD Display Icons



Icon	Function								
Input source information									
	Indicates the AC input								
	Indicates the 1 st PV panel input								
	Indicates the 2 nd PV panel input								
Left digital display information									
	Indicate input voltage, input frequency, battery voltage, PV1 voltage, PV2 voltage, charger current								
Middle digital display information									
	Indicates the setting programs.								
	Indicates the warning and fault codes. Warning: Flashing with warning code Fault: display with fault code								
Right digital display information									
	Indicate the output voltage, output frequency, load percent, load VA, load W, PV1 charger power, PV2 charger power, DC discharging current.								
Battery information									
	Indicates battery level by 0-24%, 25-49%, 50-74% and 75-100% and charging status.								
Load information									
	Indicates overload.								
	Indicates load level by 0-24%, 25-49%, 50-74%, 75-100%.								
	<table border="1"> <tr> <td>0%~24%</td> <td>25%~49%</td> <td>50%~74%</td> <td>75%~100%</td> </tr> <tr> <td></td> <td></td> <td></td> <td></td> </tr> </table>	0%~24%	25%~49%	50%~74%	75%~100%				
0%~24%	25%~49%	50%~74%	75%~100%						
Mode operation information									
	Indicates unit connects to the mains.								

	Indicates unit connects to the 1 st PV panel
	Indicates unit connects to the 2 nd PV panel
	Indicates the solar charger is working
	Indicates the DC/AC inverter circuit is working.
Mute operation	
	Indicates unit alarm is disabled.

LCD Setting

After pressing and holding "▲" or "▼" button for one second, the unit will enter setting mode. Press "▲" or "▼" button to select setting programs. And then, press "←" button to confirm the selection or "↻" button to exit.



***IMPORTANT:** It's requested to enter password in the setting program with *. It will show $\frac{P}{\text{⊙}}$ in the screen. Please press "▲" or "▼" button to change showing numbers. The password is "000". Press "←" button to confirm password numbers.





Program	Description	Selectable option	
01	Operation mode	Grid-tied with Backup I $\frac{01}{\text{⊙}} \underline{3d1}$ (default)	Mode 1 PV priority: Battery >> Load >> Grid
		Grid-tied with Backup II $\frac{01}{\text{⊙}} \underline{3d2}$	Mode 2 PV priority: Load >> Battery >> Grid
		Grid-tied with Backup III $\frac{01}{\text{⊙}} \underline{3d3}$	Mode 3 PV priority: Load >> Grid >> Battery
		Grid-tied with Backup IV $\frac{01}{\text{⊙}} \underline{3d4}$	Mode 4 PV priority (peak time): Load >> Battery >> Grid. PV priority (Off-peak time): Battery >> Load >> Grid
		Grid-tied with Backup V $\frac{01}{\text{⊙}} \underline{3d5}$	Mode 5 PV priority (Grid is high): Load >> Battery >> Grid
		Grid-tied only $\frac{01}{\text{⊙}} \underline{3d6}$	Mode 6 PV priority: Grid-tied only
		Off-Grid $\frac{01}{\text{⊙}} \underline{3d7}$	Mode 7 PV priority: Load >> Battery
02	Charger source priority	Solar and Utility $\frac{02}{\text{⊙}} \underline{5nu}$ (default)	Solar energy and AC will charge together

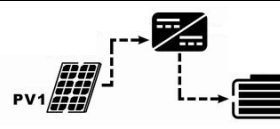
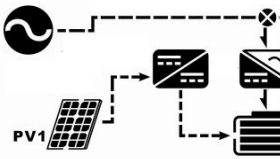
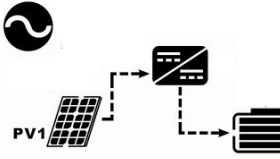

		Only Solar 02 050	Only charge by Solar energy
		None 02 non	Charger disabled
03	Load Supply Source	03 Sbu (default)	PV >> Battery >> Grid
		03 Sub	PV >> Grid >> Battery
04	AC Charger	AC charge enabled 04 ACE (default)	AC charger disabled 04 ACd
05	Feed-in to the grid	Feed-in to Grid disable 05 FId	Feed-in to Grid enabled 05 FIE (default)
06	Battery Feed-in the grid	Battery discharge enabled 06 bFE	Battery discharge disabled 06 bFd (default)
07	AC Charger ON timer	Default 00:00 07 00 ^h	AC charger from 00:00 to 23:00
08	AC Charger OFF timer	Default 00:00 08 00 ^h	Stop AC charger from 00:00 to 23:00
09	AC Output ON timer	Default 00:00 09 00 ^h	AC output on from 00:00 to 23:00
0A	AC Output OFF timer	Default 00:00 0A 00 ^h	AC output off from 00:00 to 23:00
11	Regulation standard * (*It's required to enter password)	00: VDE 11 00	01: AS4777 11 01
		02: dk 11 02	03: RD1663 11 03
		04: G83 11 04	05: Taiwan 11 05
		06: USH 11 06	07: USL 11 07
		08: VDE4105(default) 11 08	09: Korea 11 09
		10: Hongsun 11 10	11: Sweden 11 11
12	Nominal output volt. *	208V	220V

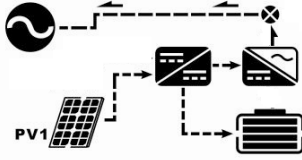

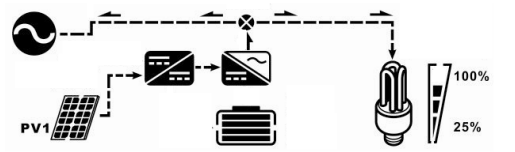

	(*It's required to enter password)	12 208 ^v ⊗	12 220 ^v ⊗
		230V 12 230 ^v ⊗ (default)	240V 12 240 ^v ⊗
13	Nominal output freq. * (*It's required to enter password)	13 50 ^{Hz} ⊗ (default)	13 60 ^{Hz} ⊗
21	Max. feed-in grid power	21 5.5 ^{KW} ⊗	Default 5500W, 0-5.5KW
22	Max. charging current	22 60 ^A ⊗	Default 60A, 5~60A
23	Max. AC charging current	23 60 ^A ⊗	Default 60A, 5~60A
24	Bulk charging voltage	24 50 ^v ⊗	Default 56.0V, 50~62V
25	Floating charging voltage	25 50 ^v ⊗	Default 54V, Range 50~62V
26	Stop discharge voltage when grid unavailable	26 40 ^v ⊗	Default 42V, Range 40~51V
27	Stop discharge voltage when grid available	27 40 ^v ⊗	Default 48V, Range 40~51V
28	Start discharge voltage when grid available	28 42 ^v ⊗	Default 54V, Range 42~62V
29	Start discharge voltage when grid unavailable	29 42 ^v ⊗	Default 54V, Range 42~62V
2A	Max. battery discharging current in hybrid mode	2A 125 ^A ⊗ ^{BATT}	Default 150A, 20~150A
2B	Generator compatible	Enabled 2b 00E ⊗	Disabled (default) 2b 00d ⊗
2C	LCD backlight sleep timer	Backlight on 2c 100 ⊗	Default 60s, Range 0~100s
2D	Alarm control	Alarm on 2d 60n ⊗ (default)	Alarm off 2d 60f ⊗
31	Real time setting – Minute	31 0 ⊗	Default 00, Range 00 ~ 59
32	Real time setting – Hour	32 00 ⊗	Default 00, Range 00 ~ 23
33	Real time setting – Date	33 1 ⊗	Default 01, Range 01 ~ 31
34	Real time setting – Month	34 1 ⊗	Default 01, Range 01 ~ 12
35	Real time setting – Year	35 0 ⊗	Default 16, Range 16 ~ 99

Operating Mode Description

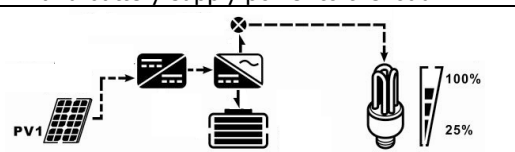
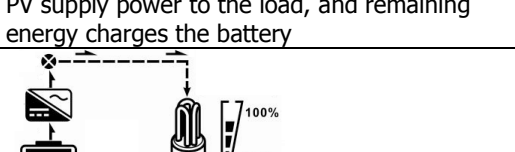
Operating	Behaviors	LCD display
Standby mode (*Charge mode)	No output power, solar or utility charger available	 <p>Only utility power available, charger priority is OSO, no charging.</p>
		 <p>Only utility power available, charger priority is not OSO, charged by utility power.</p>
		 <p>Only PV available, charged by PV power. *</p>
		 <p>Utility power and PV available, charger priority is SNU, feed to grid disable or PV energy no remain power to feed to grid, charging by utility and PV.</p>
		 <p>Utility power and PV available, charger priority is not SNU, feed to grid disable or PV energy is not enough to charge battery, charging by PV</p>

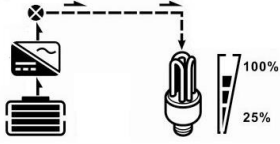
		 <p>Utility power and PV available, feed to grid is enabled and PV energy is larger and it charges battery,</p> <ol style="list-style-type: none"> 1. PV charge battery. 2. Remain energy feed to grid.
		 <p>No charging.</p> <p>Only utility power available, charger priority is OSO. **</p> <ol style="list-style-type: none"> 1. No charging. 2. SUB or SBU&&Battery not high to discharge, no discharge. 3. Utility power provides power to the load.
Grid mode (**Bypass mode)	Output power from utility. Charger available	 <p>Only utility power available, charger priority is not OSO, SUB or SBU&&battery not high to discharge.</p> <ol style="list-style-type: none"> 1. AC charging the battery. 2. Utility power provides power to the load.
		 <p>Only utility power available, SBU&&battery is high enough to discharge,</p> <ol style="list-style-type: none"> 1. Battery discharge, no charging. 2. Battery and utility power provide power to the load.





		 <p>PV and utility power available, PV doesn't charge battery.</p> <ol style="list-style-type: none"> 1. No charging. 2. PV provides power to the load. 3. PV feeds energy to the grid.
		 <p>PV and utility power available, PV energy is well enough to charge battery and provide energy to load, feed to grid is enabled and it has enough power to feed to grid</p> <ol style="list-style-type: none"> 1. PV charges the battery. 2. PV provides power to the load. 3. PV feeds energy to the grid.
Battery mode	Output power from battery or PV	 <p>PV and battery supply power to the load</p>  <p>PV supply power to the load, and remaining energy charges the battery</p>  <p>PV is not available, and battery supplies power to the load</p>

		  <p>When utility power is available, the utility icon will show.</p>
Fault mode	No output	  <p>When there is only utility power available, no charging occurs no matter what the priority is.</p>
		 <p>No PV or AC, no charging</p>

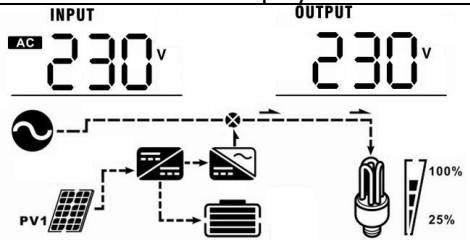
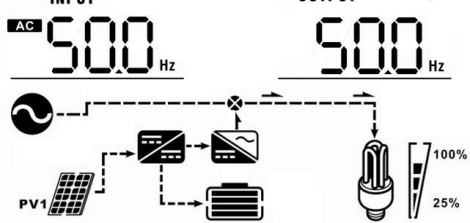
Select Displays

The LCD display will be switched in turns by pressing "UP" or "DOWN" key. The selectable information is switched in order as: input voltage, input frequency, PV voltage, battery voltage, charging current, output voltage, output frequency, load percentage, load in VA, load in Watt, and load in Watt. If no button be pressed in 1 min, it will return to default display.

Selection	LCD display
Input voltage and output voltage	
Input frequency and output frequency	

<p>Battery voltage and output voltage</p>	<p style="text-align: center;">BATT OUTPUT</p> <p style="text-align: center;">480^v 230^v</p> 
<p>Battery voltage and load percentage</p>	<p style="text-align: center;">BATT LOAD</p> <p style="text-align: center;">480^v 68 %</p> 
<p>Battery voltage and load VA</p>	<p style="text-align: center;">BATT LOAD</p> <p style="text-align: center;">480^v 108^{k VA}</p> 
<p>Battery voltage and load W</p>	<p style="text-align: center;">BATT LOAD</p> <p style="text-align: center;">480^v 188^{kW}</p> 
<p>PV1 voltage and PV1 input power</p>	<p style="text-align: center;">INPUT</p> <p style="text-align: center;">PV1 269^v 158^{kW}</p> 

<p>PV2 voltage and PV2 input power</p>	<p>INPUT</p> <p>PV2 269 V 158 kW</p>
<p>Charging current</p>	<p>INPUT BATT</p> <p>30 A</p>
<p>PV energy (by day)</p>	<p>DAY 63 kWh</p>
<p>PV energy (in total)</p>	<p>ALL 63 kWh</p>
<p>Real Date</p>	<p>07 14</p>
<p>Real time</p>	<p>17 14</p>

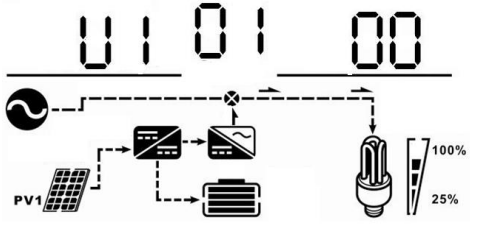
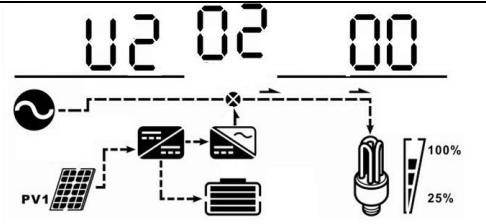
DSP firmware version (FW issued date)	
MCU firmware version (FW issued date)	

15. Charging Management

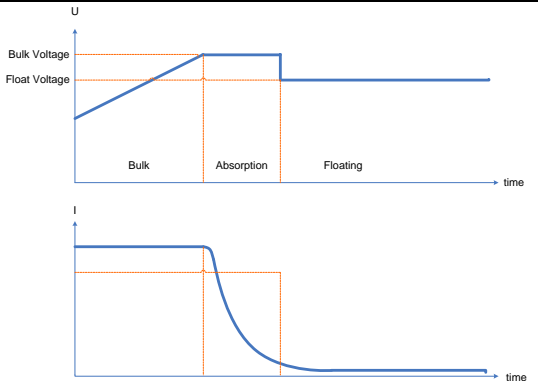
Charging Parameter	Default Value	Note
Charging current	60A	It is adjustable via software from 5Amp to 60Amp.
Floating charging voltage (default)	54.0 Vdc	It is adjustable via software from 50Vac to 62Vdc.
Max. absorption charging voltage (default)	56.0 Vdc	It is adjustable via software from 50Vac to 62Vdc.
Battery overcharge protection	64.0 Vdc	
Charging process based on default setting. 3 stages: 1st – max. charging voltage increases to 56V; 2nd - charging voltage will maintain at 56V until charging current is down to 12 Amp; 3rd - floating charging is at 54V.		

This inverter can connect to following battery types: sealed lead acid battery, vented battery, gel battery and lithium battery. The detailed installation and maintenance explanations of the external battery pack are provided in the manual of the manufacturer’s external battery pack.

If using sealed lead acid battery, please set up the max. charging current according to the formula below:

The maximum charging current = Battery capacity (Ah) x 0.2

For example, if you are using 300 Ah battery, then, maximum charging current is 300 x 0.2=60 (A). Please use at least 50Ah battery because the settable minimum value of charging current is 10A. If using AGM/Gel or other types of battery, please consult with installer for the details.

Please refer to the setting below:

The screenshot shows a 'Parameters setting' window with the following parameters and values:

Parameter	Value	Unit	Action
Min. grid-connected voltage:	184	V	Apply
Max. grid-connected voltage:	264.5	V	Apply
Min. grid-connected frequency:	47.48	Hz	Apply
Max. grid-connected frequency:	51.5	Hz	Apply
The waiting time before grid-connection:	60	Sec.	Apply
Max. grid-connected average voltage:	253	V	Apply
Max. feed-in grid power:	10,000	W	Apply
Min. PV input voltage:	300	V	Apply
Max. PV input voltage:	900	V	Apply
Min. MPP voltage:	350	V	Apply
Max. MPP voltage:	850	V	Apply
Max. charging current:	60	A	Apply
Max. AC charging current:	60	A	Apply
Bulk charging voltage(C.V. voltage):	56	V	Apply
Start LCD screen-saver after:	None	Sec.	Apply
Floating charging voltage:	54	V	Apply
Battery cut-off discharging voltage when Grid is available:	48	V	Apply
Battery re-discharging voltage when Grid is available:	54	V	Apply
Battery cut-off discharging voltage when Grid is unavailable:	42	V	Apply
Battery re-discharging voltage when Grid is unavailable:	48	V	Apply
Battery temperature compensation:	0	mV	Apply
Feeding grid power calibration:	0	W	Apply
Max. battery discharge current in hybrid mode:	10	A	Apply
Mute Buzzer alarm:	<input type="radio"/> Enable <input checked="" type="radio"/> Disable		Apply
Generator as AC source:	<input type="radio"/> Enable <input checked="" type="radio"/> Disable		Apply
Mute the buzzer in the Standby mode:	<input type="radio"/> Enable <input checked="" type="radio"/> Disable		Apply
Activate Li-Fe battery while commissioning:	<input type="radio"/> Yes <input checked="" type="radio"/> No		Apply
Mute alarm in battery mode:	<input type="radio"/> Enable <input checked="" type="radio"/> Disable		Apply
Wide AC input range:	<input type="radio"/> Enable <input checked="" type="radio"/> Disable		Apply

When float charging current is less than X (A) and continued T (Min),then charger off; when battery voltage is less than Y (V),then charger on again.

X: 0 A T: 60 Min. Y: 53 V Apply

Any schedule change will affect the power generated and shall be conservatively made.

System time: 2014-10-27
14:03:21 Apply

Close

16. Maintenance & Cleaning

Check the following points to ensure proper operation of the whole solar system at regular intervals.

- Ensure all connectors of this inverter are cleaned all the time.
- Before cleaning the solar panels, be sure to turn off PV DC breakers.
- Clean the solar panels during the cool time of the day, whenever it is visibly dirty.
- Periodically inspect the system to make sure that all wires and supports are securely fastened in place.

WARNING: There are no user-replaceable parts inside the inverter. Do not attempt to service the unit by yourself.

Battery Maintenance

- Servicing of batteries should be performed or supervised by personnel with knowledge about batteries and the required precautions.
- Replace the batteries with the same type and number of batteries or battery packs.
- The following precautions should be observed when working on batteries:
 - a) Remove watches, rings, or other metal objects.
 - b) Use tools with insulated handles.
 - c) Wear rubber gloves and boots.
 - d) Do not lay tools or metal parts on top of batteries.
 - e) Disconnect charging source prior to connecting or disconnecting battery terminals.
 - f) Determine if battery is inadvertently grounded. If inadvertently grounded, remove source from ground. Contact with any part of a grounded battery can result in electric shock. The likelihood of such shock can be reduced if such grounds are removed during installation and maintenance (applicable to equipment and remote battery supplies without a grounded supply circuit).

CAUTION: A battery can present a risk of electric shock and high short-circuit current.

CAUTION: Do not dispose of batteries in a fire. The batteries may explode.

CAUTION: Do not open or mutilate batteries. Released electrolyte is harmful to the skin and eyes. It may be toxic.

17. Trouble Shooting

When there is no information displaying in the LCD, please check if PV module/battery/grid connection is correctly connected.

NOTE: The warning and fault information can be recorded by remote monitoring software.

17-1. Fault code reference

When a fault occurs, the icon **ERROR** will flash as a reminder. See below for fault codes for reference.

Situation		Solution
ERROR	Fault Event	
01	DC bus voltage exceeds the upper threshold	Disconnect AC circuit breaker first. Then, disconnect DC circuit breaker. Until LCD screen completely shuts down, turn on DC breaker first. It will show "No Utility" in LCD screen. Then, turn on AC breaker. After 300 seconds, the system will automatically connect to the grid. If the error message still remains, please contact your installer.
02	DC bus voltage falls below the lower threshold	
03	DC bus voltage soft-start is time-out	
04	Inverter soft-start is time-out	
05	An Inverter overcurrent event is detected	
07	An relay failure event is detected	
08	DC component in the output current exceeds the upper threshold	
11	Over-current on PV input is detected	
14	Inverter DC component exceeds the allowable range	
16	Leakage current CT failed	
06	Over temperature fault	The internal temperature is higher than specified temperature. Leave inverter to cool down to room temperature. If the error message still remains, please contact your installer.
09	PV input voltage exceeds the upper threshold	Check if the open circuit voltage of PV modules is higher than 500VDC. If PV open circuit voltage is less than 500VDC and the error message remains, please contact your installer.
10	Auxiliary power* failed *Auxiliary power means switch power supply.	Turn off the inverter. Then, restart the inverter. If the error message still remains, please contact your installer.
12	Leakage current exceeds the allowable range	The ground voltage is too high. Please disconnect AC breaker first and then DC breaker. Check if grounding is connected properly after LCD screen

		<p>completely shuts down.</p> <p>If grounding is correctly connected, turn on DC breaker. After it displays "No Utility" in LCD screen, turn on AC breaker. After 300 seconds, the system will automatically connect to the grid.</p> <p>If the error message still remains, please contact your installer.</p>
13	PV insulation resistance is too low	<p>Check if the impedance between positive and negative poles to the ground is greater than 1MΩ.</p> <p>If the impedance is lower than 1MΩ, please contact your installer.</p>
15	A difference occurred in the readings from the main and secondary controllers	<p>Please disconnect AC breaker first and then disconnect DC breaker.</p>
17	Communication with the main and secondary controllers is interrupted	<p>After LCD screen is completely off, turn on DC breaker. Until it shows "No Utility" in LCD display, turn on AC breaker.</p>
20	Discharge circuit fault	<p>After 300 seconds, the system will automatically connect to the grid.</p>
21	Soft start in battery discharge fails	<p>If error message remains, please contact your installer.</p>
22	Charging voltage is too high	<p>Check if the connection between battery and inverter is good. Make sure battery condition is ok. Then, restart the inverter. If error message remains, please contact your installer.</p>
23	Overload fault	<p>Remove excessive loads. Be sure the total power consumption of the connected loads are less than that of the maximum which this inverter can support. Then, restart the inverter.</p>
24	Battery disconnected	<p>Check if battery cable is connected firmly. If error message remains, please contact your installer.</p>
25	Inverter current is too high for a long time	<p>Remove excessive loads.</p> <p>Then, restart the inverter.</p>
26	Short circuited on inverter output	<p>Turn off the inverter.</p> <p>Disconnect AC circuit breaker first.</p> <p>Then, disconnect DC circuit breaker and then disconnect the loads.</p> <p>Please check if load circuit is ok. After removing the error, turn on the PV DC</p>

		breaker and battery breaker. Turn on the inverter. If error message remains, please contact your installer.
27	Fan fault	Please check if fans are running ok. If fans are running ok, please shut down inverter first and then restart it. If fans stop running or error message remains after restart the inverter, please contact your installer.
28	OP Current Sensor fault	Shut down the inverter completely. Restart the inverter to see if it's ok. If error message still remains, please contact your installer.
29	Charger failure	Shut down the inverter completely. Restart the inverter to see if it's ok. If error message still remains, please contact your installer.
30	Version mismatch between controller board and power board	Shut down the inverter completely. Restart the inverter to see if it's ok. If error message still remains, please contact your installer.
31	Reverse connection of input and output wires	Shut down the inverter completely. Check if grid wires are connected to AC output terminals. If mis-connected, re-connect it correctly. And turn on the inverter again. If error message still remains, please contact your installer.

17-2. Warning Reference Codes

When a warning event occurs, the icon  will flash as a reminder. See warning codes below for reference.

Situation		Solution
	Warning Event	
02	Internal EEPROM failed	Restart the unit again. If problem still exists, please contact your installer.
04	Battery low	Recharge or replace the battery
07	Overload	Try to reduce the applied load
17	Battery open	Re-connect the battery
20	Over temperature	Check the ventilation around the unit Try to reduce the load Check if fans run normally

18. Specifications

MODEL	5.5KW
RATED POWER	5500 W
PV INPUT (DC)	
Maximum DC Power	6500 W
Nominal DC Voltage	360 VDC
Maximum DC Voltage	500 VDC
Working DC Voltage Range	120 VDC ~ 500 VDC
Start-up Voltage / Initial Feeding Voltage	116 VDC / 150 VDC
MPP Voltage Range	120 VDC ~ 450 VDC
Full Load MPP Voltage Range	250 VDC ~ 450 VDC
Maximum Input Current	2*13 A
GRID OUTPUT (AC)	
Nominal Output Voltage	230 VAC
Output Voltage Range	184 - 265 VAC
Output Frequency Range	47.5 ~ 51.5 Hz or 59.3~ 60.5Hz
Max. Output Current	23.9 A
AC INPUT	
AC Start-up Voltage	120-140 VAC
Auto Restart Voltage	180 VAC
Acceptable Input Voltage Range	170 - 280 VAC
Nominal Frequency	50 Hz / 60 Hz
AC Input Power	5500VA/5500W
Maximum AC Input Current	40 A
BATTERY MODE OUTPUT (AC)	
Nominal Output Voltage	230 VAC Pure sine wave
Output Frequency	50 Hz / 60 Hz (auto sensing)
Output Power	5500VA/5500W
Efficiency (DC to AC)	93%
BATTERY & CHARGER (Lead-acid/Li-ion)	
DC Voltage Range	40 – 63 VDC
Nominal DC Voltage	48 VDC
Maximum Battery Discharging Current	150 A
Maximum Charging Current	60 A
GENERAL	
PHYSICAL	
Dimension, D X W X H (mm)	110 X 450 X 445
Net Weight (kgs)	16
INTERACE	
Communication Port	RS-232/USB
Intelligent Slot	Optional SNMP, Modbus, AS-400
ENVIRONMENT	
Humidity	0 ~ 90% RH (No condensing)
Operating Temperature	-10 to 40°C