

# PrograMill PM5

## Operating Instructions





---

# Table of Contents

<b>1</b>	<b>About this Document</b>	<b>6</b>
1.1	Target group	6
1.2	Signs and symbols	7
1.3	Abbreviations	8
1.4	Supporting documents	9
1.5	Revision and validity	9
<b>2</b>	<b>Safety</b>	<b>10</b>
2.1	Intended use	10
2.2	Operator's obligations	12
2.3	Personnel qualifications	12
2.4	Staff obligations	13
2.5	Personal protective equipment	13
2.6	Working areas, potential hazards and safety measures on the device	14
2.7	Safety instructions for potential hazard areas	16
2.8	Safety instructions for individual operating phases	19
<b>3</b>	<b>Design and Function</b>	<b>21</b>
3.1	Marking and labelling of the milling machine	21
3.2	Design of the PrograMill System	23
3.3	PrograMill Base set	33
<b>4</b>	<b>Transportation and Assembly</b>	<b>40</b>
4.1	Choosing the location site	40
4.2	Transporting the device to the place of work	41
4.3	Unpacking the unit	42
4.4	Checking delivery content and condition	43
4.5	Setting-up the unit	44
<b>5</b>	<b>Initial Operation</b>	<b>46</b>
5.1	Removing the transport protection	46
5.2	Setting up and connecting the PrograMill Suction Unit or any other extraction system (can be ordered separately)	47

## Table of Contents

---

5.3	Preparing the PrograMill Tank and Filter and connecting to the device	48
5.4	Connecting the compressed air supply to the device	52
5.5	Connecting the device to the power supply	53
5.6	Connecting the device to the local network (LAN)	54
5.7	Switching the device on for the first time	55
<b>6</b>	<b>Operating the Operating Panel</b>	<b>59</b>
6.1	Overview of the control panel	60
6.2	Main menu [Overview]	62
6.3	Main menu [Job list]	68
6.4	Main menu [Tools]	74
6.5	Main menu [Status]	83
6.6	Main menu [Settings]	86
<b>7</b>	<b>Making General Setting Changes in the Operating Panel</b>	<b>88</b>
7.1	Viewing and editing device status	88
7.2	Changing settings	90
<b>8</b>	<b>Editing Milling Jobs</b>	<b>95</b>
8.1	Switching the machine on	95
8.2	Configuring and managing tool magazines and tools	96
8.3	Managing discs and blocks	111
8.4	Preparing milling jobs	127
8.5	Starting the milling job	133
8.6	Finishing/ejecting a completed milling job	136
8.7	Displaying the Job Archive (depends on version)	142
8.8	Shutting the device down and switching it off	143
<b>9</b>	<b>Device Messages and Troubleshooting</b>	<b>144</b>
9.1	Messages and warnings in the operating panel	144
9.2	Conducting the calibration procedure	147
9.3	Troubleshooting / error table	150
<b>10</b>	<b>Cleaning and Maintenance Work for the User</b>	<b>154</b>
10.1	Cleaning and maintenance table	154
10.2	Preparing for cleaning	156

10.3	Cleaning the milling chamber and the seal of the front flap	157
10.4	Cleaning the measuring probe	159
10.5	Cleaning the drawer under the milling chamber (service flap)	160
10.6	Checking and emptying the sieve insert on the PrograMill Tank	162
10.7	Cleaning the collet	164
10.8	Cleaning the material changer	166
10.9	Servicing the compressed air supply	167
10.10	Checking/cleaning the backwater flap	167
10.11	Cleaning the housing	169
10.12	Changing the coolant fluid in the PrograMill Tank	170
10.13	Changing the PrograMill filter cartridge for the tank	173
10.14	Finishing the cleaning procedure	175
<b>11</b>	<b>Decommissioning</b>	<b>176</b>
11.1	Storing the device	176
11.2	Disposing of the device	176
<b>12</b>	<b>Repair</b>	<b>177</b>
12.1	Authorized service partners	177
12.2	Sending defective devices for repair	177
<b>13</b>	<b>Technical Data</b>	<b>178</b>
13.1	Classifications	178
13.2	Measurements, weight	178
13.3	Ambient conditions	179
13.4	Electrical data	179
13.5	Compressed air consumption and requirements on incoming compressed air	180
<b>14</b>	<b>Appendix</b>	<b>181</b>
14.1	Delivery form	181
14.2	Ordering spare parts	181
14.3	Recommended additional components	182
14.4	Approved tools	183

# 1 About this Document

These Operating Instructions will familiarize you with the PrograMill PM5 features.

PrograMill PM5 is a modern 5-axis milling system for dental applications. This device has been developed and produced according to the latest state-of-the-art technology.

Improper use can be dangerous. Please observe the relevant safety instructions and read the Operating Instructions carefully.

The Operating Instructions are an integral part of the device and are valid for all named machines.

The Operating Instructions describe the safe and correct use in all operating processes.

Should you lose these Operating Instructions, you can download them from [www.ivoclarvivadent.com](http://www.ivoclarvivadent.com).



For all types of technical questions, please contact your authorized service partner.

---

## 1.1 Target group

Target group	Duties
Operator	<ul style="list-style-type: none"><li>• Keep these Operating Instructions available at the place where the unit is used, also for future use.</li><li>• Request personnel read and observe these Operating Instructions and the applicable documents, in particular the safety instructions and warnings ("Safety", page 10).</li><li>• Observe additional device-related stipulations and regulations.</li></ul>
Dental technician	<ul style="list-style-type: none"><li>• Read and observe these Operating Instructions and the applicable documents, in particular the safety instructions and warnings ("Safety", page 10).</li></ul>
Qualified dental staff members	
CNC technician	
Authorized Ivoclar Vivadent service partner	



## 1.2 Signs and symbols

### 1.2.1 Warnings

Warnings are used in these Operating Instructions to warn you of a risk of injury to persons and/or damage to property.

1. Please always read and observe these warnings.
2. Follow all measures marked with the warning symbol and warning word.

Depending on the severity and probability of the danger, the following warning levels are distinguished:

Warning symbol	Warning word	Danger level	Consequences resulting from non-observance
	DANGER	Immediate imminent danger	Death, severe personal injury
	WARNING	Potential danger	Death, severe personal injury
	CAUTION	Potential danger	Slight personal injury
-	NOTICE	Potential danger	Damage to property

Clarification of the structure of a warning:

---

 **WARNING! Name of source of danger, cause of hazard or type of risk.**

Consequences of non-compliance with instructions.

- ▶ Action in order to avoid danger.

---

Hazard example:

---

 **WARNING! Risk of injury due to heavy lifting.**

Injuries to the back due to overloading.

- ▶ Only lift the appliance with the aid of the fork lift.
  - ▶ Unpack the device after transportation.
-

## About this Document

---

### 1.2.2 Signs and symbols

Symbol	Significance
❗	Additional information, e.g. for better understanding, for simplifying workflows or for further information
☑	Prerequisite which must be followed before the subsequent actions can be performed
▶	Individual steps which you must perform
1., 2.	Several steps that you must perform in the given order
➔	The result indication of an operation step or several steps, for success control

### 1.3 Abbreviations

Abbreviation	Significance
CAD	Computer Aided Design. Describes the computerized support of constructive tasks for the production of a product.
CAM	Computer Aided Manufacturing. Describes the use of a software, independent of the CNC machine, for creating the NC code for the machining of milling jobs in the milling machine.
CNC	Computerized Numerical Control (CNC). Describes an electronic method for controlling machine tools (CNC machines).
CoCr	Cobalt chrome
EMC	Electromagnetic Compatibility. Describes the interference of electrical or electronic devices with their surroundings.
FI	Residual current protection system / residual current circuit breaker
LAN	Local Area Network
PMMA	Polymethyl methacrylate
RFID	Radio Frequency Identification. Describes a procedure for the identification of discs / block holders with inserted blocks by the milling machine.
Ti	Titanium



## 1.4 Supporting documents



For details on the applicable documents, please contact your local trade partner or go the download section of Ivoclar Vivadent at <http://www.ivoclarvivadent.com>.

Document	Clarification
Checklist for your PrograMill System	Information about requirements that must be observed for transport, installation and use of the PrograMill system
Operating Instructions PrograMill Suction Unit	Information about the use of the PrograMill Suction Unit (optional)
Operating Instructions PrograMill Base	Information on the assembly and installation of the base cabinet (optional)
User Manual PrograMill CAM	User Manual for the CAM software „PrograMill CAM“
Safety Data Sheet PrograMill Fluid	Information about the use of the PrograMill Fluid coolant concentrate
Documentation on the discs / blocks used	Information on the use of discs / blocks

## 1.5 Revision and validity

Version	Date	Amendments to the previous version
1.0	2019-03	First production

## 2 Safety



### **WARNING! Improper use of the device.**

Risk to the patient and the user.

- ▶ The safety chapter contains important information on the safety of the device: Please read thoroughly prior to installation and operation.
- 



The device is built according to state-of-the-art technology and recognized safety regulations. Nevertheless, its use could constitute a risk of injury of the user or third party or possibly cause impairment to the device and other property.

---

### 2.1 Intended use

PrograMill PM5 is designed for light to medium-duty milling and grinding in both wet and dry operation in the field of dental technology. Use the PrograMill PM5 exclusively for this purpose.

In the case of damage caused by improper use or failure to observe the Operating Instructions, all liability and guarantee claims are void.

Please note that only the indications, materials and milling strategies approved by the manufacturer ensure processing without damage to the machine.

The machine has been designed for milling the following materials:

- Zirconium oxide (IPS e.max® ZirCAD)
- Glass-ceramics (IPS e.max® CAD, IPS Empress® CAD)
- PMMA materials (Telio® CAD, SR Vivodent® CAD, IvoBase® CAD)
- CoCr alloys (Colado® CAD)
- Titanium/titanium alloys (Colado® CAD)
- Waxes (ProArt CAD)



Only approved discs / blocks can be identified and thus used by the device via a corresponding RFID chip on the disc (RFID label or RFID container on the disc holder) or on the block holder (RFID container on the block holder), which ensure that misapplication is nearly impossible.

Basically, all Ivoclar Vivadent materials and tools in their respective categories are suitable for processing.

All information regarding material and indication extensions corresponds to the state of knowledge at the time of going to print. For additional details, go to <http://www.ivoclarvivadent.com>.

It is not recommended to process materials or use tools from other manufacturers in this system due to the absence of milling strategy coordination and lack of tool harmonization.

### 2.1.1 Potential improper use

The device is not suitable for milling procedures outside of the dental field.

The following is considered as misuse of the system:

- Non-compliance with the specified intended use, intended operator specifications or intended environment
- Modifications, maintenance and repairs without prior authorization from Ivoclar Vivadent
- Operation with inappropriate parameters

Improper use of the device can lead to the following:

- Danger for patient and operating personnel
- Impairment of the operability of the device

Ivoclar Vivadent assumes no liability for damage resulting from improper use.

Typical misapplications of the device to be avoided:

Improper use	Consequences
Use of not approved materials or tools	Damage to the device
Incorrect cleaning (filter, milling chamber, changer)	<ul style="list-style-type: none"> <li>• Skin irritations</li> <li>• Environmental damage</li> <li>• Damage to the device</li> </ul>
Operation without coolant concentrate PrograMill Fluid	<ul style="list-style-type: none"> <li>• Damage to the device</li> <li>• Service life of device and filter is reduced</li> </ul>
Shut-down of the device by the user during the milling operation	<ul style="list-style-type: none"> <li>• Damage to tools and discs or blocks</li> <li>• Calibration may be necessary</li> </ul>
Operation without the tank (only applies in the case of wet operation)	Device will stop
Operation without the suction unit and filter	

### 2.1.2 Intended operator

The device may only be operated by qualified dental staff, dental technicians and CNC technicians who have received training for operating the device.

The user is responsible for selecting the correct device settings.

### 2.1.3 Intended environment

The device is only permitted for use in closed rooms, within the specified ambient conditions ("Ambient conditions for operation", page 179) and in compliance with the requirements for safe installation ("Choosing the location site", page 40).

## 2.2 Operator's obligations

The operator is responsible for the safe operation of the device.

- ▶ Ensure compliance and control:
  - a. Intended use
  - b. Statutory or other safety and accident prevention regulations
- ▶ Only operate the device in a technically perfect condition, in a proper, safety-conscious and risk-conscious manner and while observing these Operating Instructions.
- ▶ Keep these instructions and all applicable documents complete, legible and accessible to personnel at all times.

## 2.3 Personnel qualifications

- ▶ Ensure that the personnel assigned to work with the device have read and understood these instructions and all applicable documents, in particular safety, maintenance and repair information, before starting work.
- ▶ Ensure that personnel is aware of hazards and safety equipment ("Working areas, potential hazards and safety measures on the device", page 14).
- ▶ Manage the responsibilities, competence and monitoring of staff.
- ▶ All work must only be carried out by qualified technical staff.
- ▶ Personnel to be trained should only carry out work on the unit under the supervision of qualified technical personnel.

## 2.4 Staff obligations

- ▶ Only operate the device in a technically perfect condition, in a proper, safety-conscious and risk-conscious manner and while observing these Operating Instructions.
- ▶ Refrain from any process that could endanger staff or third parties.
- ▶ In the case of safety-related malfunctions, switch off the device immediately and allow the fault to be rectified by the person responsible.
- ▶ In all cases of doubt regarding the safety of the appliance, switch off the appliance and prevent further use.
- ▶ In addition to the overall documentation, legal or other safety and accident prevention regulations including applicable standards and guidelines of the respective operating country must be complied with.
- ▶ Do not wear jewellery such as rings, bracelets or watches when working on the appliance, especially when cleaning the milling chamber. Danger of crushing or cutting injuries.

## 2.5 Personal protective equipment

- ▶ If loud operating noise cannot be prevented (sound level  $\geq 80$  dBA), use hearing protectors during milling.
- ▶ For protection against milling dust, vapours or other particles of dental materials during cleaning work wear a protective mask (half mask with protection class FFP3).
- ▶ When carrying out cleaning work, wear gloves.
- ▶ When handling the PrograMill Fluid coolant concentrate and when cleaning the unit, wear suitable protective equipment (see "Safety Data Sheet PrograMill Fluid", "Supporting documents", page 9).

## 2.6 Working areas, potential hazards and safety measures on the device

As an operator, you are working at the areas described below.

The device is built according to state-of-the-art technology and recognized technical safety regulations. Hazardous areas, which cannot be avoided by design, are equipped with appropriate protective devices. Nevertheless, if the machine is used improperly, there is a danger to life or risk of injury to the user or third parties. In addition, the device, tool or workpiece may become damaged.

The working areas, their potential hazards and applicable safety measures are shown below:

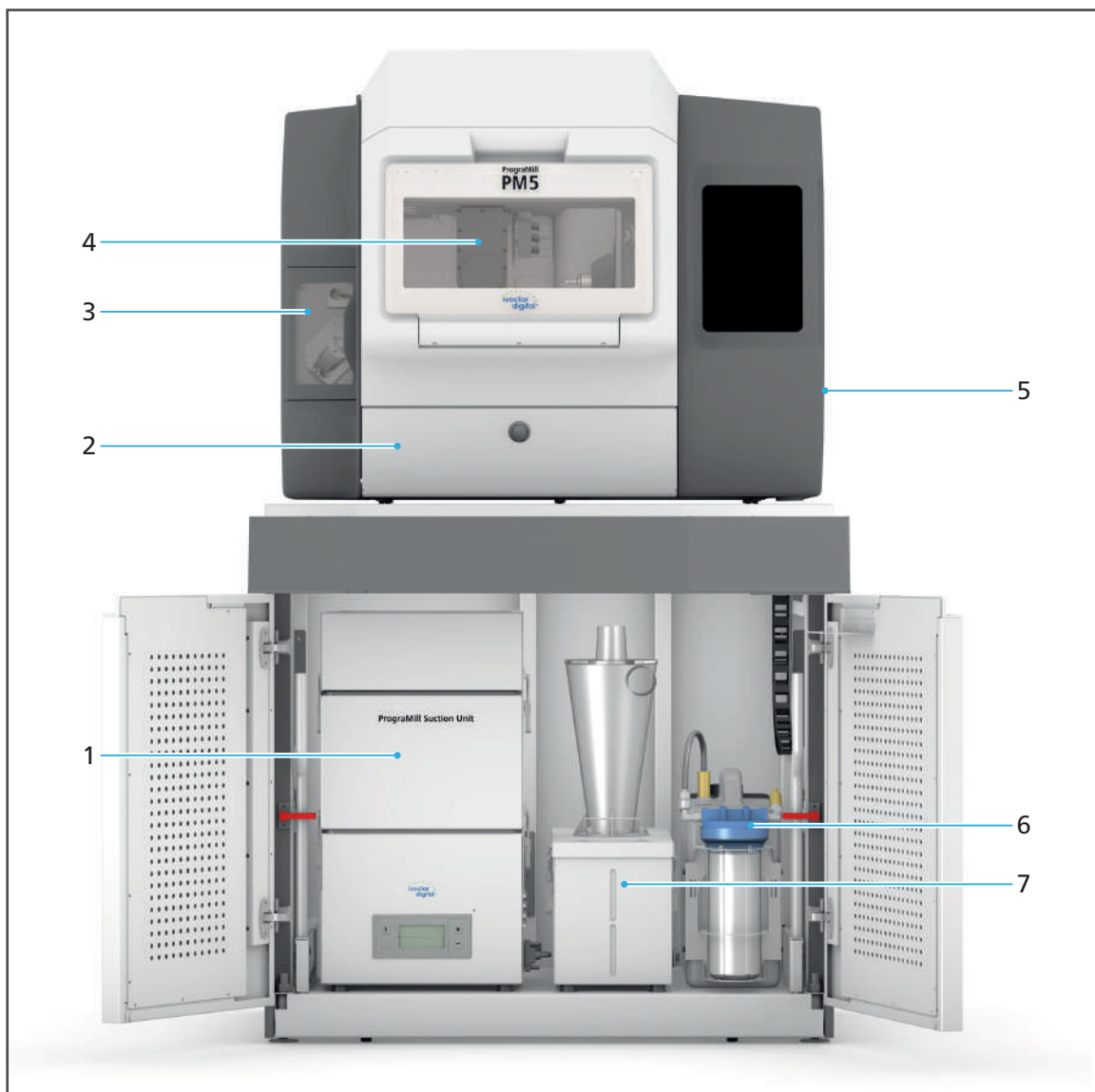

No.	Working area	Tasks / Work	Safety measures	Protective effect
1 + 7	PrograMill Suction Unit (1) with separator (7), optional	See the Operating Instructions for the PrograMill Suction Unit ("Supporting documents", page 9)		
2	Service flap and drawer	Cleaning duties	Safety contact	When the flap is open, safety-relevant components such as the material changer will stand still.
3	Material changer	Placement of discs / blocks	Safety contact	<ul style="list-style-type: none"> <li>• Protection against crushing</li> <li>• When the flap is open the device will stand still.</li> </ul>
4	Milling chamber	Placement of tools Cleaning when the device stands still	Safety lock of the front flap. Access to the milling chamber is not possible during operation.	<ul style="list-style-type: none"> <li>• Protection against crushing and cutting injuries from the tools</li> <li>• When the flap is open the device will stand still.</li> <li>• The flap cannot be opened when the device is running.</li> </ul>
5	Connections (right side)	Connection to compressed air, water inlet/ outlet, electricity, network connection	Cover, fuse, clearly identifiable connections	Protection against electric shock, health risks and danger to the environment due to leaking coolant fluid.
6	PrograMill Tank and Filter	Removal of the tank for filling with coolant fluid and filter exchange	Clearly marked tube connections	<ul style="list-style-type: none"> <li>• Protection against health risks and danger to the environment due to leaking coolant fluid.</li> <li>• Without the tank, wet operation cannot be started.</li> </ul>

## 2.7 Safety instructions for potential hazard areas

### 2.7.1 Electromagnetic waves

This equipment may cause interference to radio communications or interfere with the operation of equipment in the vicinity.

- ▶ To avoid injury to the user, never remove the housing covers.
- ▶ Do not use devices that generate electromagnetic waves together in the same room as this device.
- ▶ Take appropriate measures in the case of radio interference, e.g. a new orientation, a new device position or isolating measures.
- ▶ Only use the original accessories recommended and supplied by the manufacturer. Failure to do so can result in increased interference emissions or decreased immunity of the device.

### 2.7.2 Mechanics

Whilst the device is in operation, there are the following risks in the milling chamber or in the material changer:

- Risk of crushing
- Cutting injuries caused by tools
- Danger of flying chips
- Damage to the machine
- ▶ To avoid injury to the user from inside the unit, never remove the covers, flaps or doors.
- ▶ Only operate the device when the flaps / doors are shut. Never bypass safety equipment or put it out of operation, in particular the flaps / doors.
- ▶ Do not reach into the material or tool changer.
- ▶ Do not open the flaps / doors to the material or tool changer with force.
- ▶ Only reach into the milling chamber for the work described in this document and under the stated preconditions ("Configuring and managing tool magazines and tools", page 1 and "Cleaning and Maintenance Work for the User", page 154).

### 2.7.3 Sound emission

The sound emission strongly varies depending on the material being processed and the milling conditions ("Classifications", page 178).

In the case of higher sound emissions, which may damage your hearing:

- ▶ Visually inspect the disc / the block and the tool.
- ▶ Check the fixation of the disc / block in the disc or block holder.
- ▶ If loud operating noise cannot be prevented (sound level  $\geq 80$  dBA), use hearing protectors during milling ("Personal protective equipment", page 13).



## 2.7.4 Electrical safety

If covers are opened or parts are removed which are only accessible with tools, voltage-carrying components may be exposed. The plugs may also be under voltage. There is a risk of electric shock!

- ▶ Electrical work must only be carried out by your authorized service partner.
- ▶ Before connecting the device, check that the supply voltage and frequency are correct at the point of installation ("Electrical data", page 179 and the information on the type plate, see "Marking and labelling of the milling machine", page 1).
- ▶ To avoid injury to the user and for cooling reasons and fire protection, never remove the housing covers.
- ▶ Observe the manufacturer's installation instructions for house installation ("Supporting documents", page 9, checklist for your PrograMill system).
- ▶ To avoid the risk of electric shock, only connect the device to the power supply with a protective conductor, do not reach into the connections on the right side of the housing or manipulate them and do not reach into the housing interior via the service flap, the material changer or tool changer.
- ▶ The mains plug is used as a supply circuit disconnecting means. Always connect the mains plug to an easily accessible protective contact socket.
- ▶ The device and the suction unit must be connected to a grounded and freely accessible protective contact socket, each in a separately protected circuit. Make sure that there are no devices connected which cause strong mains voltage fluctuations when they are switched on. These fluctuations interfere with the electronic controls and may cause failure of the system.
- ▶ Make sure that the protective contact sockets are equipped with a residual current circuit breaker (FI).
- ▶ If you need to disconnect the unit from the power supply at a later time: Disconnect the plug from the mains socket, not on the device.

## 2.7.5 Pneumatics

The pneumatic components in this device are under high pressure. Sudden escape of compressed air through leaking pipes and connections or swirling hoses can cause serious injuries and damage to hearing.

- ▶ Ensure that only personnel with additional pneumatic training perform work on pneumatic components.
- ▶ Ensure that the compressed air supply meets the required system specification ("Compressed air consumption and requirements on incoming compressed air", page 180). Do not exceed the maximum permissible pressure.
- ▶ Ensure that the compressed air is clean, oil-free and dry.
- ▶ Ensure that the pneumatic components are checked regularly.
- ▶ Ensure that all defects, such as loose connections, damaged cables, etc., are dealt with immediately.

### **Before working on the pneumatics:**

- ▶ Check the main shut-off valve.
- ▶ Switch the device off ("Shutting the device down and switching it off", page 143).
- ▶ Before opening or removing a tube, make sure that it is not pressurized.

## **2.7.6 Hazardous materials**

### **Milling materials**

Depending on the material of the milled discs / blocks, without appropriate safety measures during processing there is a risk of respiratory problems caused by inhaling hazardous milling dust or chips, residues or emissions.

- ▶ Only use the device when the suction is switched on.
- ▶ Use only discs / blocks that do not present a hazard to health when the suction system is properly used.
- ▶ Only operate the suction system with the filter specified by the manufacturer.
- ▶ In order to prevent subsequent work from being damaged, always clean the device before and after processing CoCr alloys.
- ▶ When extracting carcinogenic materials and/or welding fumes from materials with a nickel or chrome content, the technical rules for the handling of hazardous substances "TRGS 560 regarding air recirculation in connection with the treatment of carcinogenic hazardous materials" must be complied with.

### **Coolant fluid/concentrate:**

Without appropriate safety measures there is a risk of skin irritations, allergic reactions and respiratory problems.

- ▶ Observe the specifications in the "Safety Data Sheet PrograMill Fluid" ("Supporting documents", page 9).

## 2.8 Safety instructions for individual operating phases

### 2.8.1 Transport

- ▶ Only transport the device according to the description in these Operating Instructions ("Transportation and Assembly", page 40).
- ▶ In order to avoid corrosion on the device and subsequent damage to the device, transport and store the device only within the permissible temperature range and ambient conditions ("Ambient conditions", page 179).

### 2.8.2 Initial operation

- ▶ Ensure that this machine is only operated by trained specialists.
- ▶ If the device has been stored in a cold environment or at high humidity, maintain a drying or temperature adjustment time of approx. 4 hours (without voltage) before initial operation, at room temperature.
- ▶ Before connecting the device, check that the supply voltage and frequency are correct at the point of installation ("Electrical data", page 179).
- ▶ Before connecting the device, check that the compressed air connections are correct at the point of installation ("Compressed air consumption and requirements on incoming compressed air", page 180).
- ▶ Ensure that the requirements for the position and the ambient conditions are complied with ("Choosing the location site", page 40 and "Ambient conditions for operation", page 179).

### 2.8.3 Operation

- ▶ Keep unauthorized persons, such as patients, children and animals, away from the unit.
- ▶ In all cases of doubt regarding the safety of the appliance, switch off the appliance and take suitable measures to prevent further use.
- ▶ Prior to connecting power or operation, check the device, the accessories and protective equipment for any damage.
- ▶ Do not use damaged, non-functioning equipment or accessories; instead notify your authorized service partner.
- ▶ In order to ensure the product safety and warranty services, the device must be exclusively operated with the original accessories from Ivoclar Vivadent. The user bears the risk when using non-approved accessories.
- ▶ Ivoclar Vivadent recommends using approved materials only to ensure process reliability.
- ▶ Note on the processing of titanium/titanium alloys: Process these material only in combination with coolant fluid. Risk of ignition of the chips!
- ▶ Never bypass the safety equipment of the machine or set it out of operation ("Working areas, potential hazards and safety measures on the device", page 14).
- ▶ Only operate the device when the milling chamber, material changer and service flap are closed and when the suction unit is connected and the filled tank/filter in place.

- ▶ To avoid damaging the unit and reducing the performance, follow the cleaning instructions and cycles (“Cleaning by the user”, page 20 and “Cleaning and Maintenance Work for the User”, page 154).
- ▶ Only operate the device unsupervised if the operating conditions for unsupervised operation described below are fulfilled.

### **Unsupervised operation:**

The machine may be operated unsupervised, provided the national and local laws and provisions allow for such action and provided that they are observed. Furthermore, the requirements of the respective insurance company must be met.

The following conditions must be complied with in order to guarantee unattended operation.

- ▶ Never use the device if the milling chamber is heavily soiled.
- ▶ Protect the device against unauthorized access.
- ▶ Ensure that the room in which the device will operate is equipped with an automatic fire alarm system.

### **Patients with cardiac pacemakers or pacemaker electrodes:**

During operation, there may be interference with other electrical medical equipment.

Patients with cardiac pacemakers or pacemaker electrodes are at risk from the following potential hazards:

- Interference with the pacemaker function
- Damage to the cardiac pacemaker
- ▶ If in doubt, either you or your patient should get in touch with a cardiologist.

## **2.8.4 Cleaning by the user**

- ▶ Only clean as specified in these instructions and observe the associated safety regulations (“Cleaning and Maintenance Work for the User”, page 154).

## **2.8.5 Improper maintenance, modifications and repairs**

Improper service and improper repairs or modifications will endanger patients and users and result in damage to the unit.

Should you carry out any repairs or maintenance to the system or modifications to the device or remove the housing without prior written consent by an authorized service partner, all warranty claims are void.

Unauthorized opening and removal of components can expose voltage-carrying components. The plugs may also be under voltage. There is a risk of electric shock!



- ▶ Maintenance as well as repairs of damaged safety equipment or machine parts must only be carried out by a service partner authorized by Ivoclar Vivadent.



## Design and Function

---

Symbols on the type plate:

Symbol	Significance
 <p>ivoclar vivadent Ivoclar Vivadent AG FL-9494 Schaan Liechtenstein</p>	Manufacturer
 <p>YYYY</p>	Year of manufacture (format YYYY, e.g. 2018)
 <p>CE</p>	This product meets the requirements of the applicable EU directives
<p>V ~ 100 - 240 Hz 50 - 60 A 3 max.</p>	Permitted supply voltage and supply frequency (depending on country)

## 3.2 Design of the PrograMill System

### 3.2.1 An overview

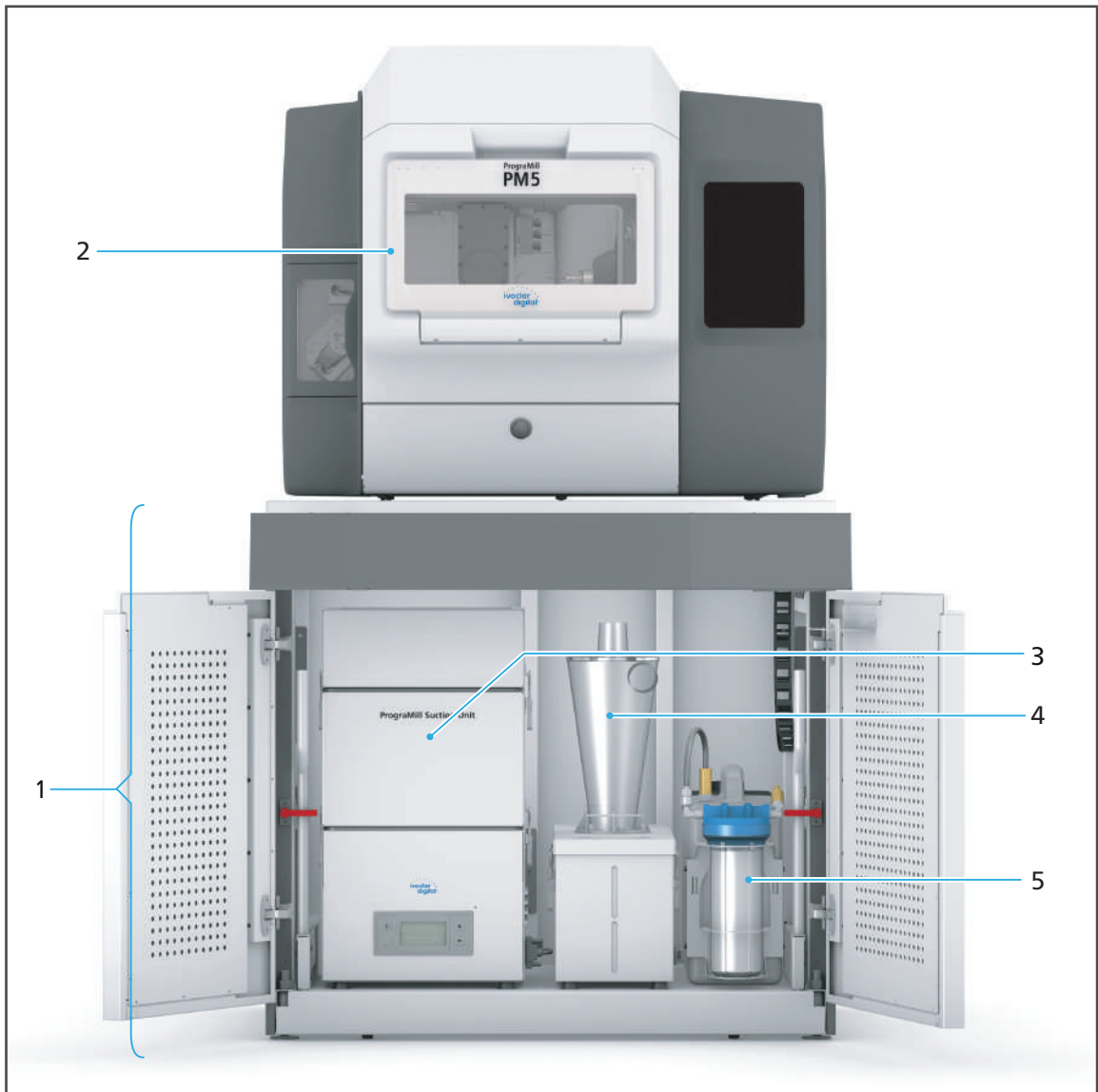

## Design and Function

---

No.	Description	Function
1	PrograMill Base cabinet (optional)	<ul style="list-style-type: none"><li>• Installation site for the milling machine</li><li>• Storage of accessories, tools and discs / blocks</li></ul>
2	CNC milling machine PrograMill PM5	Milling of discs / blocks
3	Extraction system of the PrograMill Suction Unit (optional)	Extraction of milling dust, milling vapours and other dental material particles in dry operation
4	PrograMill Suction Unit separator (optional)	
5	PrograMill Tank and Filter	Wet operation: <ul style="list-style-type: none"><li>• Part of the coolant fluid circulation</li><li>• Intake and supply of the coolant fluid into the milling chamber</li><li>• Filter for the used coolant fluid before it is (re-)used in the milling chamber</li></ul>



The PrograMill Base cabinet, the PrograMill Suction Unit components and the PrograMill Tank with integrated filter are all included in the PrograMill Base set.

---



### 3.2.2 The front of the PrograMill PM5



No.	Description	Function
1	Service flap with push-button / safety contact	Access to the drawer beneath the milling chamber. Any milling residues will accumulate in the drawer.
2	Material changer	<ul style="list-style-type: none"> <li>• Placement of discs / blocks</li> <li>• Removal of finished restorations</li> </ul>
3	Milling chamber	Processing of the discs / blocks
4	Touch screen display with operating panel / software	Operation / control of the device
5	Device feet	Height adjustment of the unit

### 3.2.3 Connections (right side)

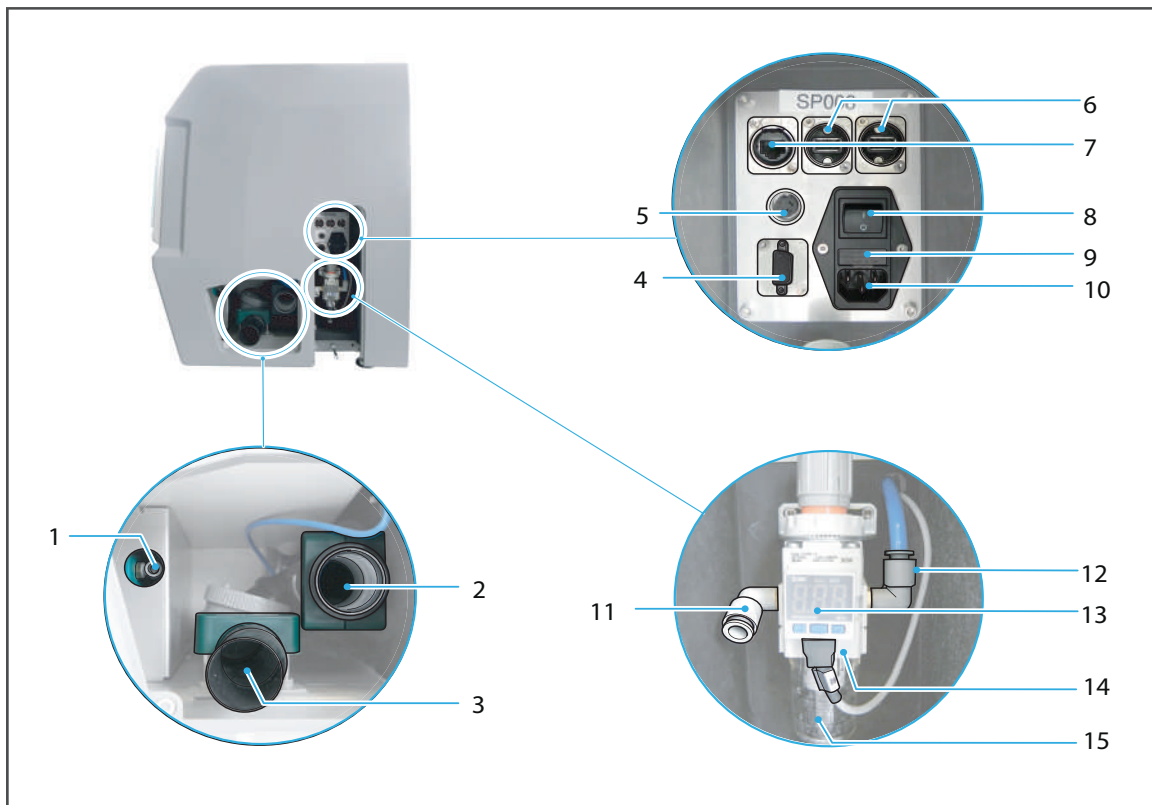

No.	Description	Function
1	Water intake	<ul style="list-style-type: none"> <li>Supply line between the PrograMill Tank and the device.</li> <li>Coolant fluid supply for wet operation.</li> </ul>
2	Suction connection	Suction of dry milling residues via the PrograMill Suction Unit
3	Water drainage	Removal of liquid milling residues
4	RS-232 connection	Connection for control cables of the suction system, e.g. PrograMill Suction Unit
5	Suction control connection (alternative)	Connection for control cable of other suction systems
6	USB connections	Connection of external USB devices or data storage
7	Network connection	Connection to the local network (LAN)

No.	Description	Function
8	On / off switch / main switch	After shutting down, the device can be switched on and off via the "End" button in the operating panel. Caution: Switching off via the on/off switch does not disconnect the device from the power supply. To fully disconnect from the power supply, unplug the power cable from the wall socket.
9	Main fuse	Only for your service partner
10	Power supply / voltage supply	Connection to the power supply
11	Connection for inlet pressure	Connection for compressed air tube for compressed air supply
12	Pneumatic cable with working pressure	Only for your service partner
13	Display of supply pressure	-
14	Pressure regulator with control connection	Control supply air pressure
15	Water separator for compressed air with drain screw	<ul style="list-style-type: none"> <li>• Filtering of liquids from the compressed air</li> <li>• Discharge of accumulated fluids by the user via drain screw ("Servicing the compressed air supply", page 167)</li> </ul>

### 3.2.4 Overview of the milling chamber

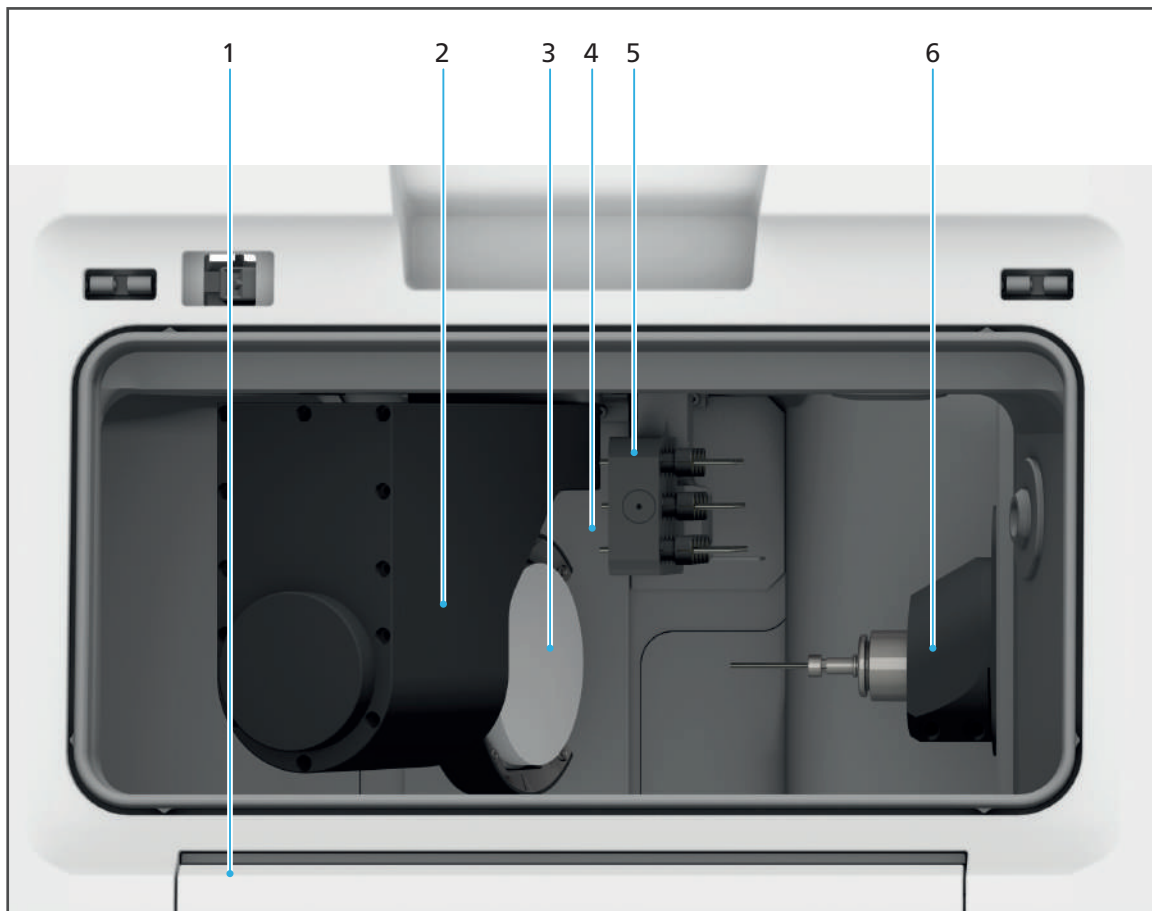

No.	Description	Function
1	Front flap with safety contact and safety interlock	Access to the milling chamber
2	Milling arm	Insertion of disc holder and block holder
3	Disc holder or block holder with disc / block inserted in the milling arm (example shown: disc holder with disc)	-
4	Door to the material changer	Placement in the milling arm (takes place automatically, no intervention by the user)
5	Tool changer with tool magazine	Placement of the tools into the spindle
6	Spindle with tools	<ul style="list-style-type: none"> <li>• Holding fixture for milling tools</li> <li>• Milling of the discs / blocks</li> </ul>

### 3.2.5 Material changer and disc and block holder

- ! Only the disc or block holder which is in the removal / insertion position (3) can be removed. In the picture below, disc holders are shown as an example.

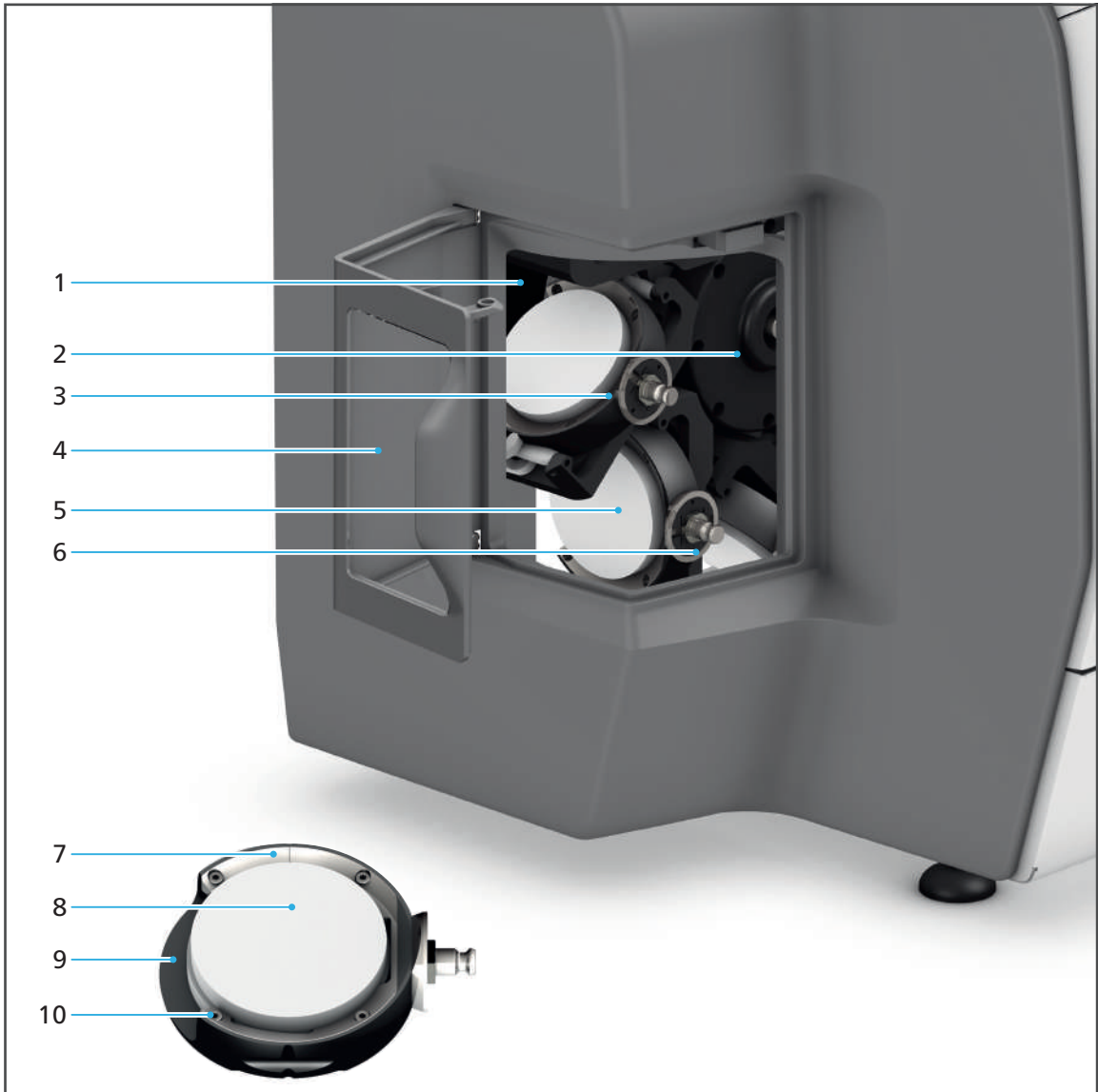

No.	Description	Function
1	RFID reader	Identification of discs / blocks for later use within a specific milling job: <ul style="list-style-type: none"> <li>• Zirconium oxide, PMMA, wax: via the RFID label on the disc</li> <li>• CoCr, Ti, IPS e.matrix: via the RFID container placed in the block holder by the user</li> </ul>

## Design and Function

---

No.	Description	Function
2	Material changer with 8 spaces for disc or block holder	Insertion of max. 8 disc or block holders for discs / blocks
3	Disc holder (with integrated disc) in removal / insertion position	Standard position for the removal / insertion of a disc holder from the / into the material changer
4	Material changer flap with safety contact	Access to material changer
5	Disc holder with disc	Insertion of discs (several variations available)
6	Unlocking of the disc holder or block holder	Removal of the disc or block holder from the material changer
7-10	Example of equipped disc holder (several variations as well as a block holder available for different materials, "Managing discs and blocks", page 111)	
7	Outer ring (disc and material dependent, several version available)	-
8	Disc (example: zirconium oxide)	-
9	Disc holder	-
10	Screws (4 pcs)	-

### 3.2.6 Tool changer and tool magazine

Tool changer with incorporated tool magazine:

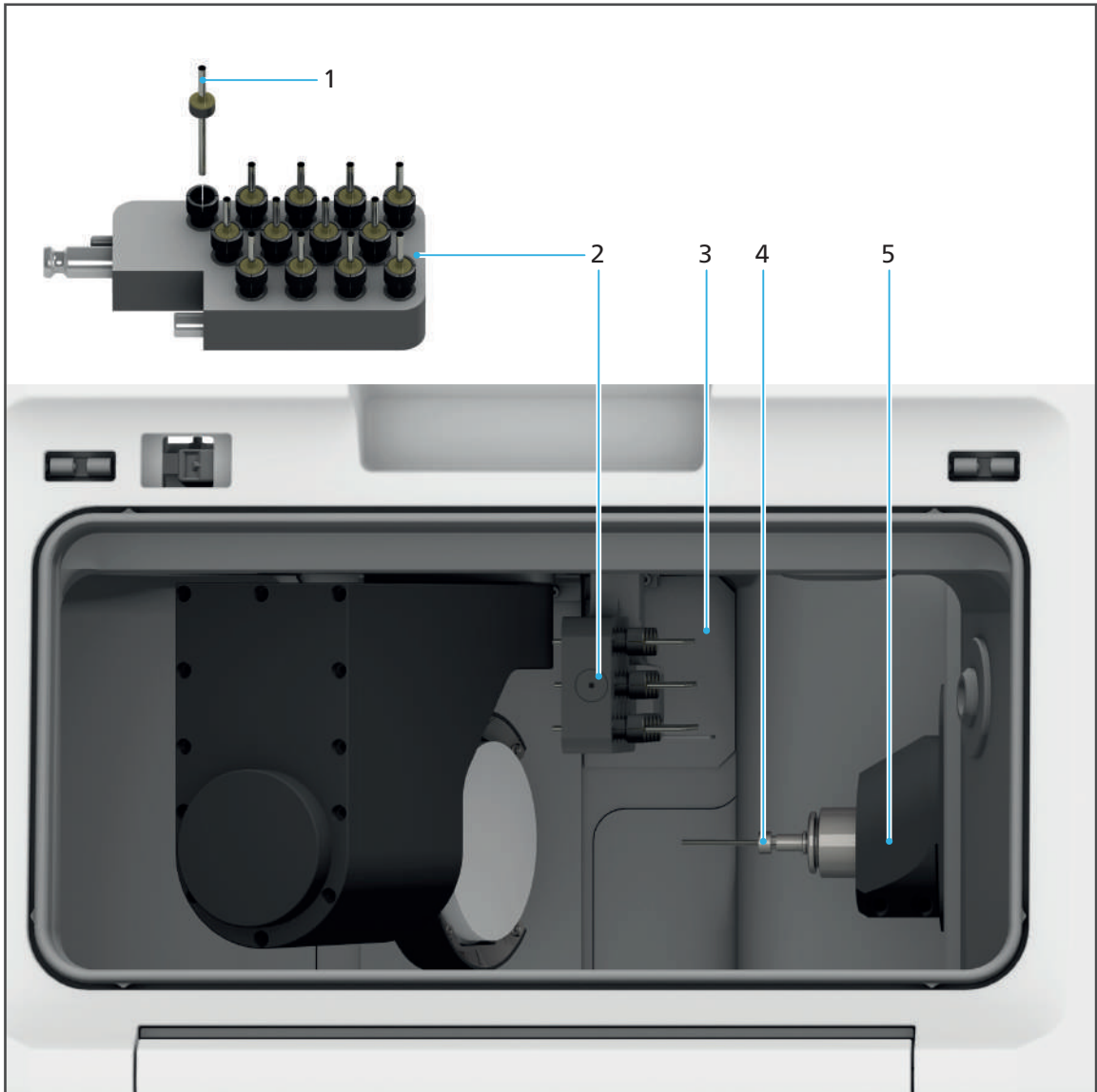

No.	Description	Function
1	Tool in the tool magazine	-
2	Tool magazine for up to 13 tools	Insertion of tools
3	Door to the tool changer	Placement in the spindle takes place automatically, no intervention by the user is required
4	Tool, inserted in the spindle	-
5	Spindle	<ul style="list-style-type: none"> <li>• Holding fixture for milling tools</li> <li>• Milling of the discs / blocks</li> </ul>

## Design and Function

Tool changer with removed tool magazine:

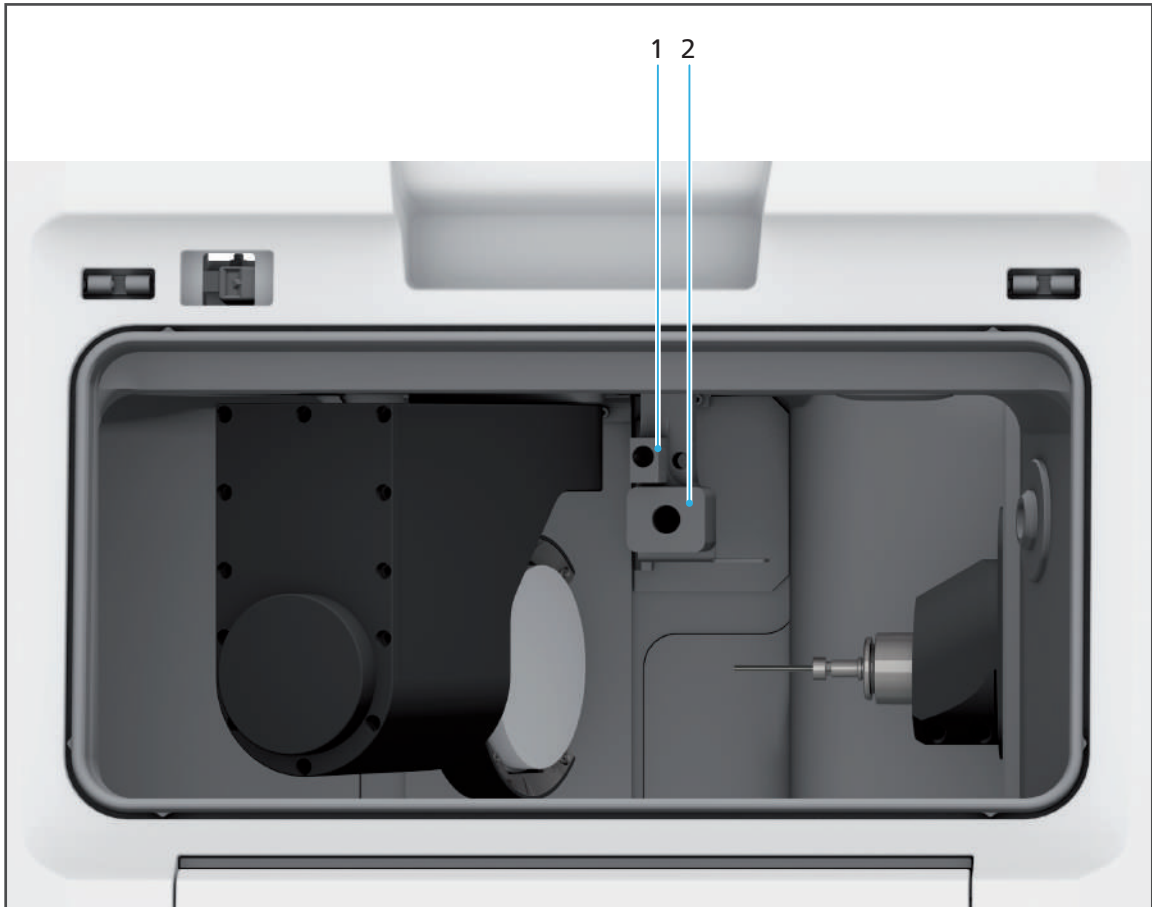

No.	Description	Function
1	Measuring probe (behind the tool magazine)	Checking the length of tools (correct length, identification of possibly broken tools, etc.)
2	Insertion of tool magazine	Attachment of the tool magazine to the tool changer



### 3.2.7 Touch screen with operating panel

You may operate your PrograMill unit via the operating panel on the integrated touch screen (1).



Information on operation can be found in section "Operating the Operating Panel", page 59.

### 3.3 PrograMill Base set

The PrograMill Base set consists of:

- PrograMill Tank with an integrated PrograMill Filter for the tank
- PrograMill Suction Unit
- PrograMill Base cabinet

### 3.3.1 PrograMill Tank and Filter

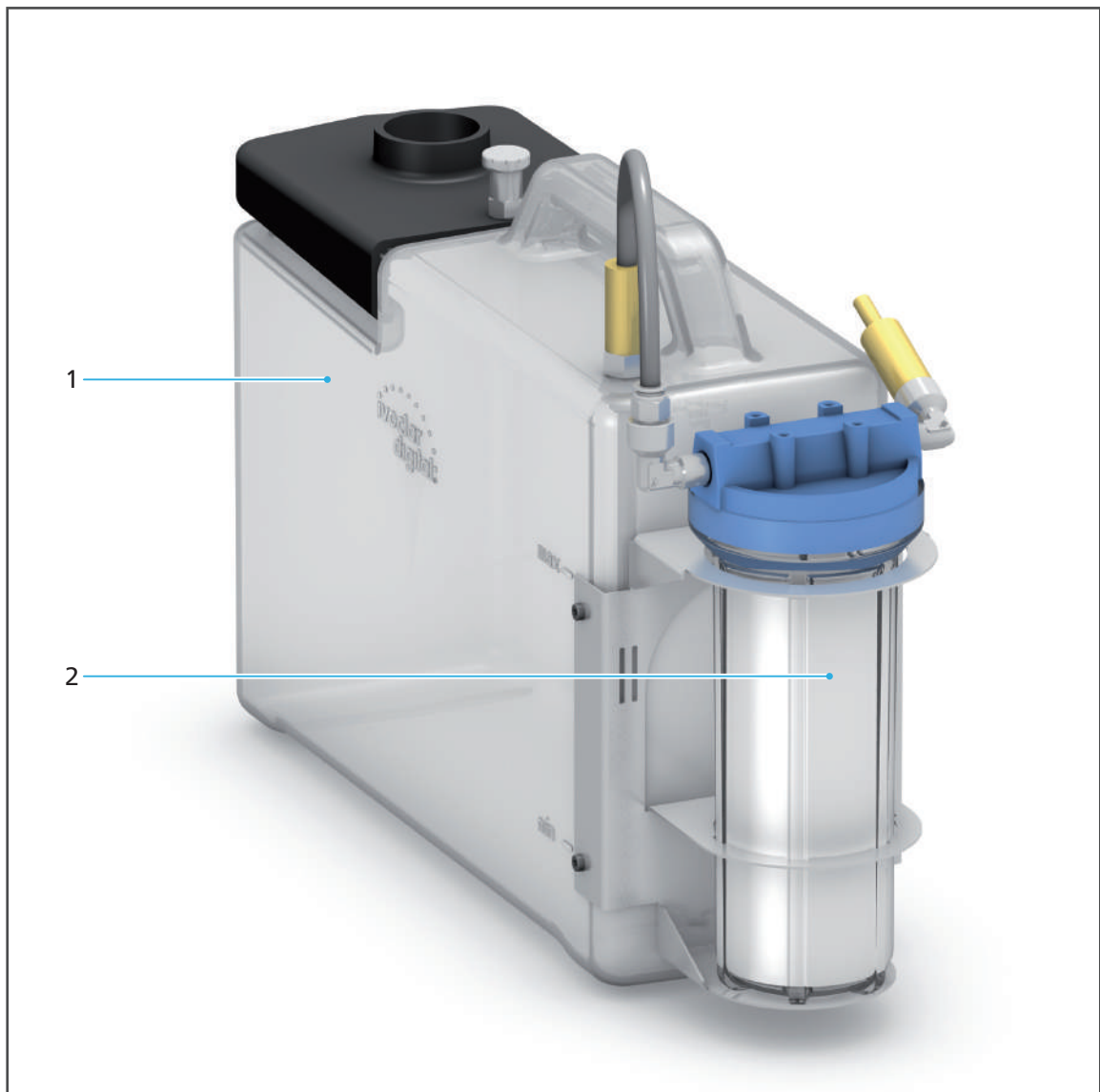

No.	Description	Function
1	PrograMill Tank	Intake and supply of coolant fluid (water + coolant concentrate PrograMill Fluid) to the milling chamber
2	PrograMill Filter for tank with filter cartridge	Filter for the used coolant fluid before it is (re-)used in the milling chamber

### 3.3.2 PrograMill Base cabinet (optional)

The PrograMill Base cabinet has been especially designed to meet the needs of the PrograMill systems. It has sufficient strength to support the PrograMill milling machines and their accessories and is designed to store and manage tools and discs / blocks.



For information on how to use the PrograMill Base cabinet, please refer to the corresponding Operating Instructions ("Supporting documents", page 9).

An empty cabinet is illustrated for better clarity.

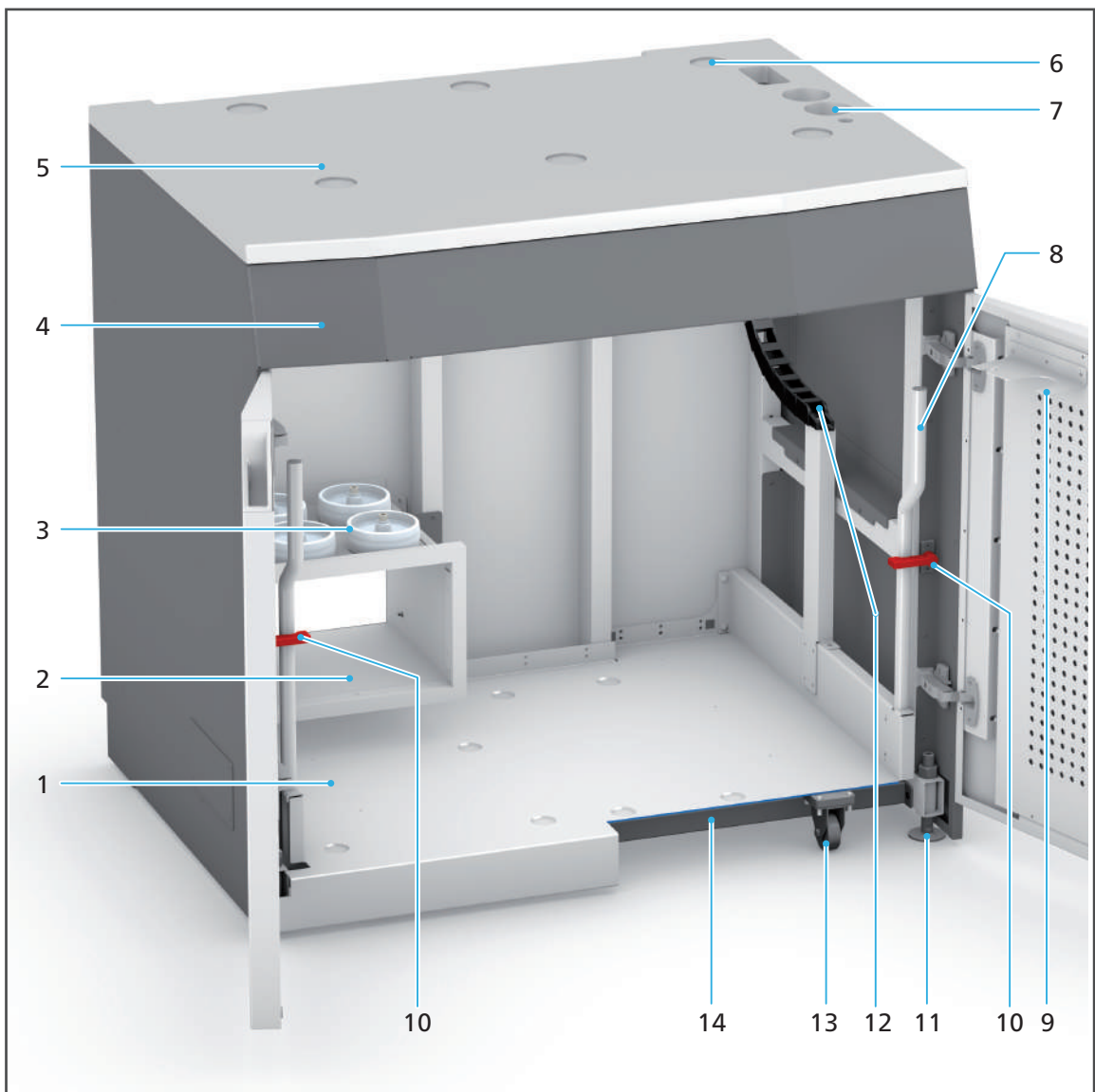

## Design and Function

No.	Description	Function
1	Pull-out shelf with indentations (in the illustration, part of the front panel has been faded out for better visibility)	<ul style="list-style-type: none"> <li>• Storage of the PrograMill Suction Unit and the PrograMill Tank / Filter</li> <li>• The indentations ensure the correct positioning of the PrograMill Suction Unit.</li> </ul>
2	Exhaust air outlet	Transfer of exhaust air to the PrograMill Suction Unit
3	Service wheels	Only for service partner
4	Drawer	Storage of tools, discs / blocks and cleaning agents
5	Surface area with indentations (6) and tube and cable access (7)	Position for the milling machine
6	Indentations for device feet	Secure positioning of the milling machine on the PrograMill Base cabinet
7	Tube and cable access	Cable and tube guides
8	Handle	Pulling out and pushing back the pull-out shelf
9	Tube holder	Connection of the water outlet tube and water inlet tube to the tube holder during cleaning and maintenance
10	Lock	Securing the pull-out shelf against unwanted movement
11	Device feet	Height adjustment of the PrograMill Base cabinet
12	Energy chain	<ul style="list-style-type: none"> <li>• Laying cables and tubes</li> <li>• Kink protection for cables and tubes</li> </ul>
13	Wheels	Pulling out and pushing back the pull-out shelf
14	Cross bar	Stabilizes the complete PrograMill system

You can store the accessories for your PrograMill system ("Delivery form", page 1) in the drawer of the PrograMill Base cabinet in the following way:

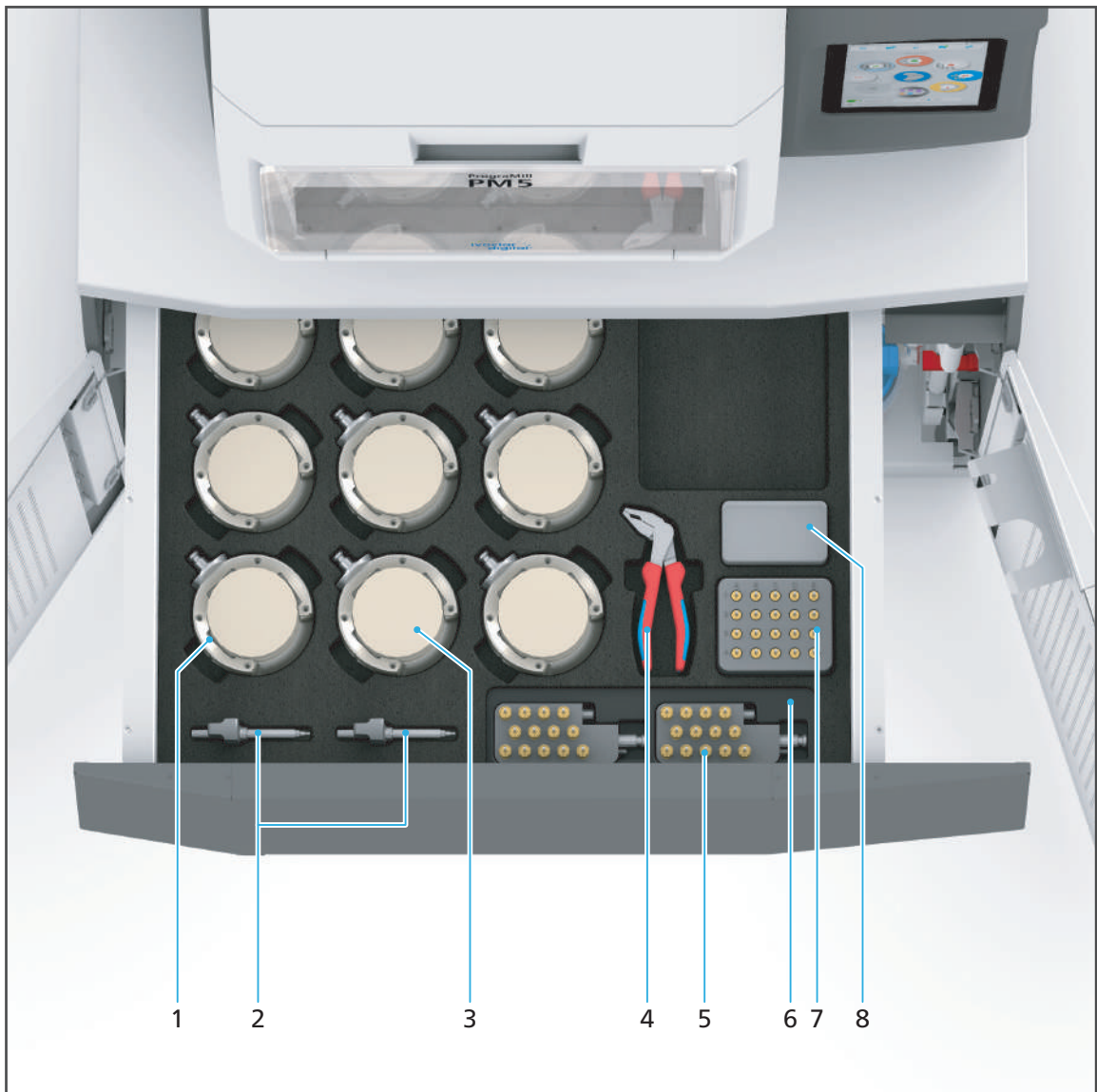

## Design and Function

---

No.	Description
1	Disc holder
2	Torque screwdriver: <ul style="list-style-type: none"><li>• 0.45 Nm for all zirconium oxide materials and wax</li><li>• 2.8 Nm for all PMMA materials and base metal alloys</li></ul>
3	Disc
4	PrograMill tool pliers
5	Tool magazine
6	Foam insert for tool magazine
7	Used Tool Library with labelled matrix for accommodating used tools ("Sub-menu [Used Tool Library]", page 6 and "Delivery form", page 1)
8	Spindle maintenance set for PM5

### 3.3.3 PrograMill Suction Unit with separator (available separately)

- ! For information on how to handle the PrograMill Suction Unit, please refer to the device operating instructions ("Supporting documents", page 9).



## 4 Transportation and Assembly

---



Transportation and assembly are carried out by your sales or service partner and a Digital Instructor as part of your PrograMill System Instruction.

**Do not perform the tasks described below alone!**

---

### 4.1 Choosing the location site

Before setting up your device, choose a suitable location site.

Make sure the following requirements are complied with:

- ▶ Observe the technical specifications for the operation and set-up site (“Supporting documents”, page 9, checklist for your PrograMill system).
- ▶ Do not use in rooms with combustible anaesthetics or other flammable gases and substances.
- ▶ Do not place or operate the device in a potentially explosive environment.
- ▶ In order to avoid overheating or corrosion on the device, only operate the device within the permissible temperature range and ambient conditions (“Ambient conditions for operation”, page 179).
- ▶ Protect the device from moisture and heat (direct sunlight, radiators or other sources of heat).
- ▶ Operate the device in a dust-free environment, as ambient air is sucked in and the filter can quickly become clogged in dusty surroundings.
- ▶ Place the device on a stable, even, non-slip and clean working surface (min. load > 500 kg). Note that the machine feet can leave marks on sensitive surfaces.
- ▶ Ensure of sufficient space underneath the location site so that the device can be transported safely by means of a lifting truck and so that accessories can be stored (PrograMill Tank and suction system).
- ▶ Ensure the device is free-standing and easily accessible.
  - a. Do not fix the device to cabinets or shelves.
  - b. Do not operate the device on or under other equipment.
  - c. Maintain a distance to other devices.
- ▶ Position the device so that there is no interference from other devices and so that it doesn't interfere with other devices.
- ▶ Ensure a minimum distance of 10 cm around the device so that ventilation performance is not restricted.
- ▶ Ensure sufficient clearance on all sides of the device for easy access to the flaps, machine connections, in particular the on/off switch.



- ▶ Risk of stumbling and falling! Avoid clutter in the workplace, keep the workplace clean, safely store cables and peripheral equipment.
- ▶ Avoid constant lopsided posture, set the workplace up ergonomically and ensure optimal seat height, position and lighting.

### 4.2 Transporting the device to the place of work

---



**WARNING! Risk of injury from the device tipping over or falling down.**

Crushing of extremities.

Damage to the device.

- ▶ Only use suitable means of transportation (e.g. fork lift trucks, capacity > 500 kg).
  - ▶ Secure the device with suitable transport straps to prevent falling (e.g. tension belts).
  - ▶ Avoid impact, jerky movements and vibration during transportation.
  - ▶ Stay well clear of suspended loads or raised parts.
- 



**WARNING! Risk of injury due to heavy lifting.**

Injuries to the back due to overloading.

- ▶ Only lift the appliance with the aid of the fork lift.
  - ▶ Unpack the device after transportation.
- 

- ▶ Move the device in its original packaging by means of transportation to the defined location.



### 4.3 Unpacking the unit

1. Bend open the tabs on all sides of the transport box cover (see magnifying glass).
2. Remove the cover of the transport box.

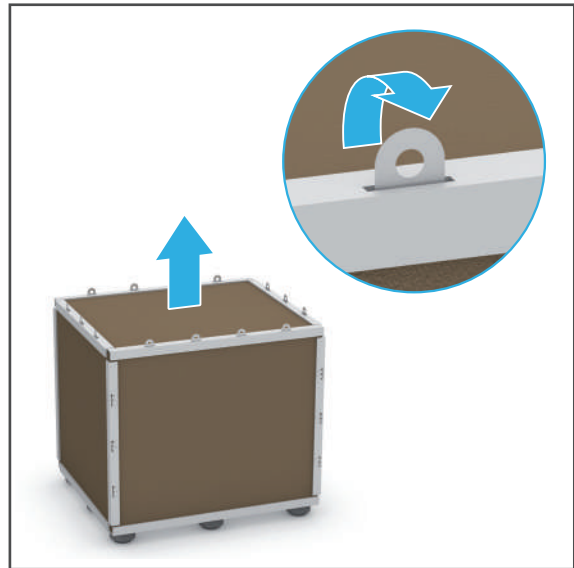

3. Bend open the tabs on all side panels of the transport box one after the other (see magnifying glass).
4. Remove each side panel, one after the other.

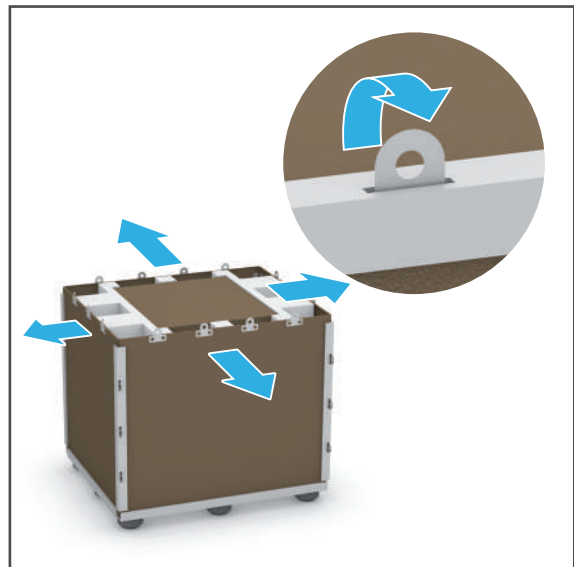

5. Lift off the box of accessories from the protective padding (1).
6. Remove the protective padding (2).

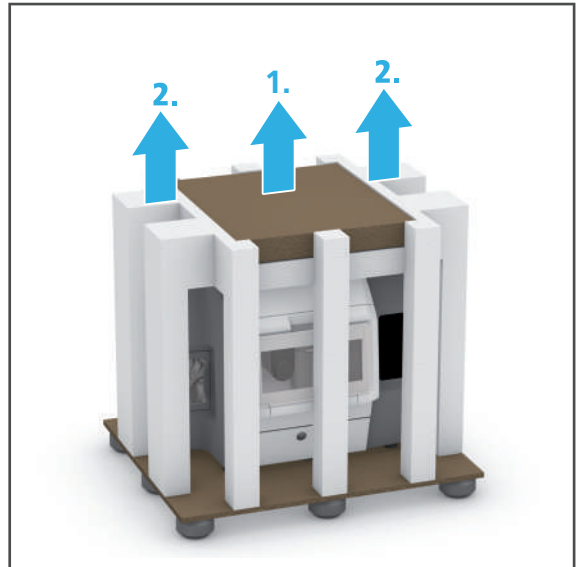

We recommend that you keep the packaging for possible maintenance and correct transportation.

---

### 4.4 Checking delivery content and condition



Please be aware that as a result of the machine approval process, residual debris may be present in the milling chamber. This does not constitute a product deficiency.

---

1. Unpack the device at the place where it is used ("Unpacking the unit", page 42).
2. Check that all contents are complete ("Delivery form", page 1).
3. Check all components for transport damage.
4. Report any transport damage or missing components immediately.

### 4.5 Setting-up the unit

You can place the unit on the separately available PrograMill Base cabinet or any other suitable working surface.

The PrograMill Base cabinet is shown below.

---

**⚠ WARNING! Risk of injury from the device tipping over or falling down.**

Crushing of extremities.

Damage to the device.

- ▶ Only use suitable means of transportation (e.g. fork lift trucks, capacity > 500 kg).
  - ▶ Secure the device with suitable transport straps to prevent falling (e.g. tension belts).
  - ▶ Avoid impact, jerky movements and vibration during transportation.
  - ▶ Stay well clear of suspended loads or raised parts.
  - ▶ Always move the machine from the fork lift to the location site with at least 6 people (weight of the milling machine: approx. 210 kg).
- 

**⚠ WARNING! Risk of injury due to heavy lifting.**

Injuries to the back due to overloading.

- ▶ Only lift the appliance with the aid of the fork lift.
- 

- ☑ The location is site selected ("Choosing the location site", page 40).
- ☑ The location site is freely accessible.
- ☑ The device is unpacked ("Unpacking the unit", page 42).
- ☑ **When using the PrograMill Base cabinet:** The PrograMill Base cabinet is set up, prepared and cross bar removed (Operating Instructions PrograMill Base, "Supporting documents", page 9).

1. Unscrew the feet of the device as far as possible with an open-ended spanner.
2. Drive the fork lift underneath the device.
3. Raise the device from the base plate of the transport box using the lift.

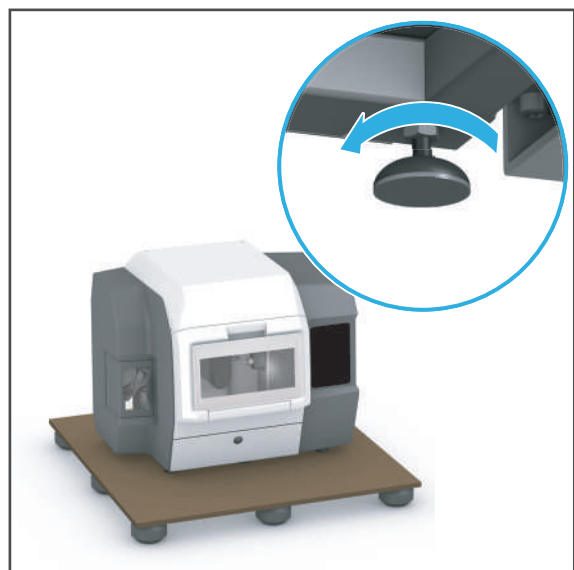

4. Position the appliance above the location site using the fork lift.

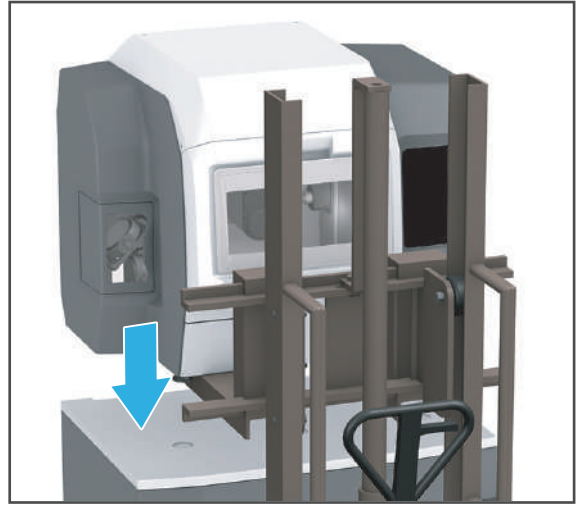

5. **When using the PrograMill Base cabinet:** Position the appliance above the cabinet so that the feet (1) can be placed in the recesses (2) provided on the cabinet.
6. Lower the device onto the work surface.
7. Adjust the feet of the appliance to the required height using an open-ended spanner and use a spirit level to ensure that the device is completely level.

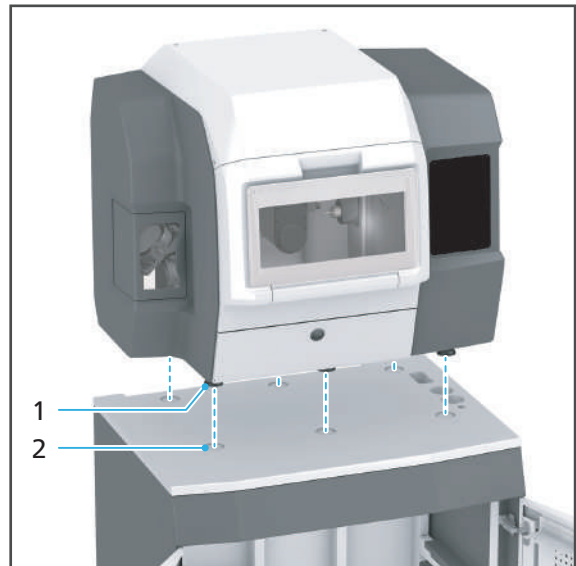

8. **When using the PrograMill Base cabinet:** Mount the cross bar (Operating Instructions for PrograMill Base, "Supporting documents", page 9).



We recommend that you keep the packaging for possible maintenance and correct transportation.

---

## 5 Initial Operation



Device set-up is carried out by your sales or service partner and a Digital Instructor as part of your PrograMill system instruction.

**Do not perform the tasks described below alone!**

Information on the CAM software "PrograMill CAM" can be found in the User Manual "PrograMill CAM" ("Supporting documents", page 9).

---

### 5.1 Removing the transport protection



The transport protection will be removed by your distribution or service partner and a Digital Instructor during initial start-up.

We recommend that you keep the transport safety equipment for possible maintenance and correct transportation.

---

**NOTICE! Using the device with transport safety equipment attached.**

Damage to the milling arm.

- ▶ Have the transport protection removed.
-

## 5.2 Setting up and connecting the PrograMill Suction Unit or any other extraction system (can be ordered separately)

You can either use the device with the PrograMill Suction Unit which is available separately, or a different suction unit which meets the required specifications ("Supporting documents", page 9, see check list for your PrograMill system).



Observe the following operating instructions when setting up and installing the suction unit:

- Operating Instructions PrograMill Base ("Supporting documents", page 9)
- Operating Instructions PrograMill Suction Unit ("Supporting documents", page 9)
- Or: Operating instructions of the relevant suction unit

The following describes how to connect the suction system using the PrograMill Suction Unit as an example. Only use the control cable supplied with the PrograMill Suction Unit and the supplied tube (2.5 m) or equivalent spare parts from Ivoclar Vivadent. The tubes and tube connections have different diameters and connection pieces so that they cannot be confused.

1. **When using the PrograMill Base cabinet:** Position the PrograMill Suction Unit in the PrograMill Base cabinet (see Operating Instructions for the PrograMill Base).

– or –

**Without the PrograMill Base:** Position the PrograMill Suction Unit below the milling machine (close to the device, within the range of the connecting cables, underneath and standing on the floor (see the Operating Instructions for the PrograMill Suction Unit or for your suction system).

2. Attach the tube which joins the PrograMill Suction Unit separator to the milling machine to the suction connection point on the device (2).
3. Connect the control cable of the PrograMill Suction Unit to the suction control connection (4).
4. **When using the PrograMill Base cabinet:** Lay the control cable and tube in the corresponding fixtures within the base cabinet (see the PrograMill Base Operating Instructions).

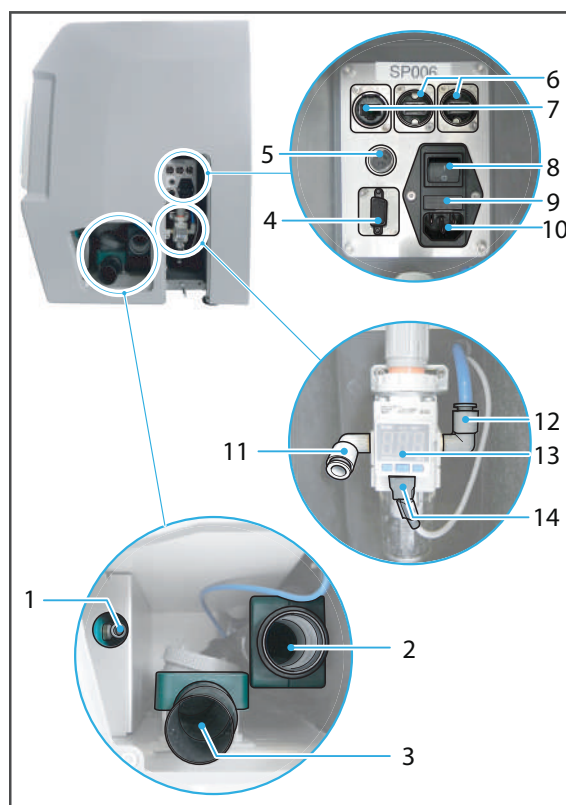



**DANGER! Leaking tube connections. Release of hazardous substances into the air circulation.**

Risk of respiratory problems.

Danger to the environment.

- ▶ Ensure that all tube connections are secure.
- 

5. Connect the tube and control cable to the PrograMill Suction Unit (see the Operating Instructions for the PrograMill Suction Unit or your own suction system).

### 5.3 Preparing the PrograMill Tank and Filter and connecting to the device

The tank with filter can be positioned either in the PrograMill Base cabinet (sold separately) or without a cabinet (near the appliance, within the reach of the connecting cables, underneath, standing on the floor).

#### 5.3.1 Filling the PrograMill Tank

The device can only be operated with a full tank and a clean filter. Otherwise an error message appears on the device and the milling procedure stops.



**DANGER! Coolant fluid has run into the electronics. Coolant fluid enters the water circulation.**

Danger of electrocution.

Damage to the device.

Danger to the environment.

- ▶ Ensure the connections and tubes are all secure and airtight.
- 



**CAUTION! Skin contact with the coolant fluid/concentrate.**

Skin irritation.

Danger to the environment with leaking coolant fluid.

- ▶ When handling the coolant fluid and components which could contain the fluid (tank, filter etc.), wear gloves.
  - ▶ Safety data sheet for the coolant concentrate PrograMill Fluid ("Supporting documents", page 9).
- 

**NOTICE! Operation of the unit without the addition of the coolant concentrate.**

Increased wear, reduced service life of the device and filter.

- ▶ Always add the tap water to the PrograMill Fluid coolant concentrate as described below.
-



1. To unlock the lid, pull the lock upwards (1) and pull the cover off from the tank in the direction of the arrow (2).



2. Remove the sieve insert (3).

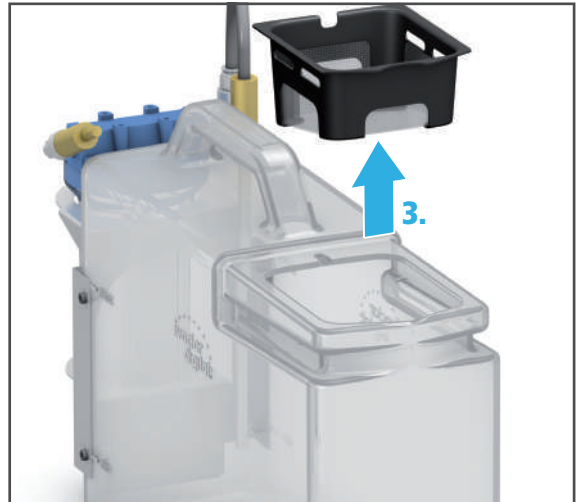

3. Fill the tank up to the fill level "max." (15 l) with tap water and PrograMill Fluid coolant concentrate (mixing ratio 7%).



## Initial Operation

---

4. Re-insert sieve insert (4).

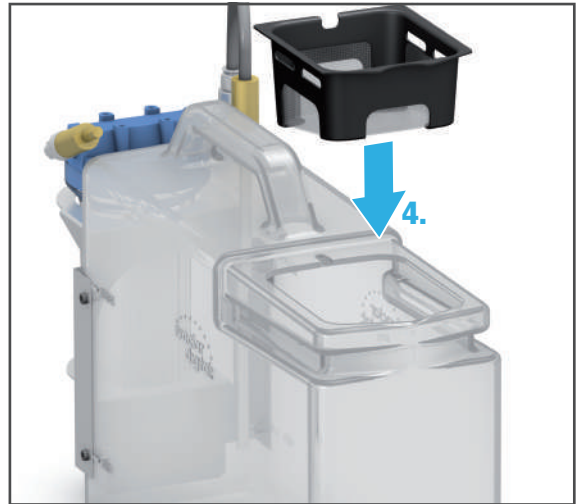

5. Place the lid on the tank and slide it in the direction of the arrow until it locks (5) in place.



- ➔ The tank and filter can now be positioned and connected.

### 5.3.2 Positioning and connecting the PrograMill Tank



The tank with the integrated filter in the PrograMill Base cabinet is shown below.

1. **When using the PrograMill Base cabinet:** Place the tank in the PrograMill Base cabinet (see Operating Instructions for the PrograMill Base, "Supporting documents", page 9).  
– or –  
**Without the PrograMill Base:** Place the tank under the milling machine (close to the unit, within the range of the connecting cables, underneath, standing on the floor).

2. Connect the water inlet tube to the connection point (1) on the milling machine.
3. Connect the water outlet tube to the connection point (3) on the milling machine.
4. **When using the PrograMill Base cabinet:** Lay tubes and cables in the cabinet (Operating Instructions from the PrograMill Base, "Supporting documents", page 9).

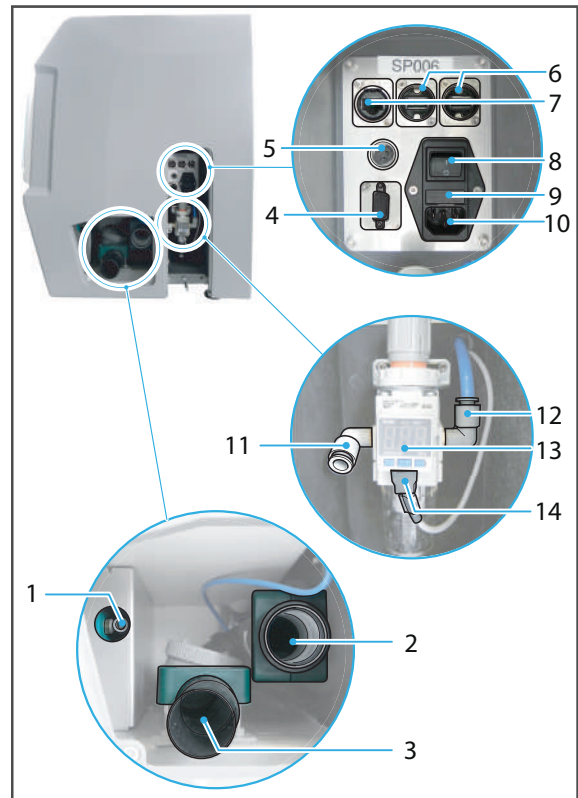

5. Attach the connection line between the filter and the tank to the corresponding connection on the tank (arrow direction (1), labelled IN on the filter lid).
6. Connect the water inlet tube to the filter (arrow direction (2), labelled OUT on the filter lid).
7. Connect the water outlet tube to the tank lid (3).

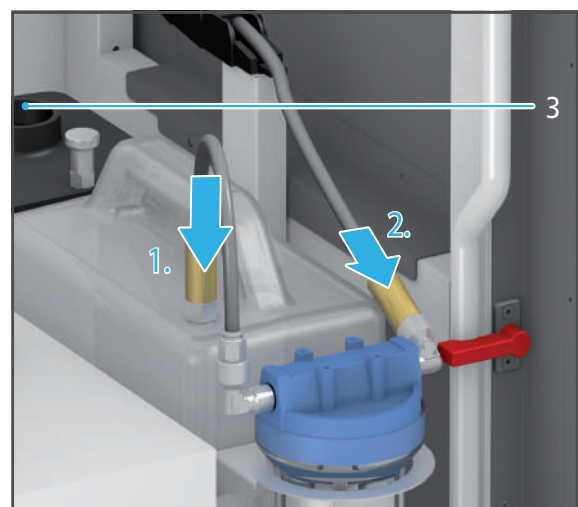

### 5.4 Connecting the compressed air supply to the device

The device can only be operated if the compressed air supply is connected. Otherwise an error message is given by the device.

**⚠ CAUTION! Leaking pipes and connections or uncontrollably swirling tubes due to improper installation.**

Severe injuries and damage to hearing.

- ▶ Observe the safety instructions ("Pneumatics", page 17).
- ▶ Observe the compressed air supply requirements ("Compressed air consumption and requirements on incoming compressed air", page 180).

The compressed air supply at the installation site is ensured ("Compressed air consumption and requirements on incoming compressed air", page 180).

1. Connect the compressed air tube to the compressed air supply at the installation site.
2. Connect the compressed air tube to the pressure regulator at the port for the inlet pressure (11).
3. Check the supply pressure at the display (13) of the pressure controller.

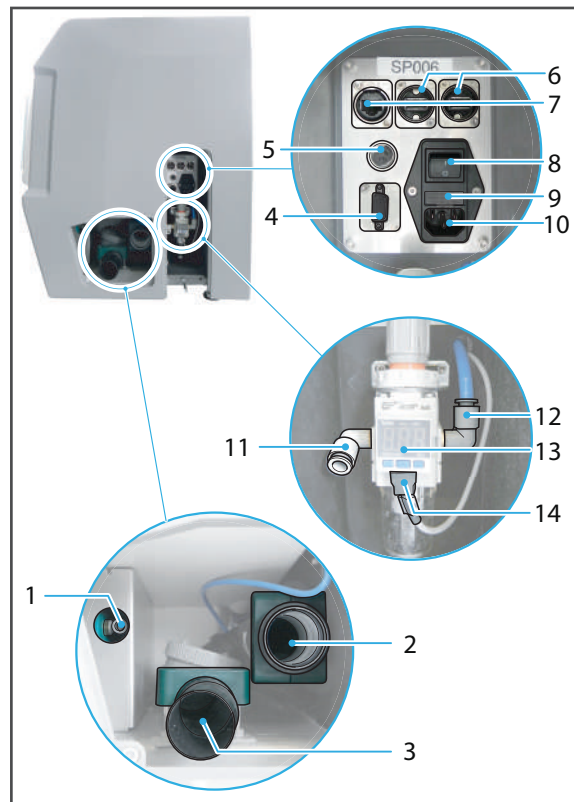

## 5.5 Connecting the device to the power supply

**!** Only use the supplied power cable or an equivalent replacement power cable from Ivoclar Vivadent.

The power supply requirements are correctly ensured ("Electrical safety", page 17, "Electrical data", page 179 and type plate, see "Marking and labelling of the milling machine", page 1).

1. Connect the power cable to the power connection (10) in the device.
2. Connect the power cable to the mains socket.

➔ Mains voltage is present on the device.

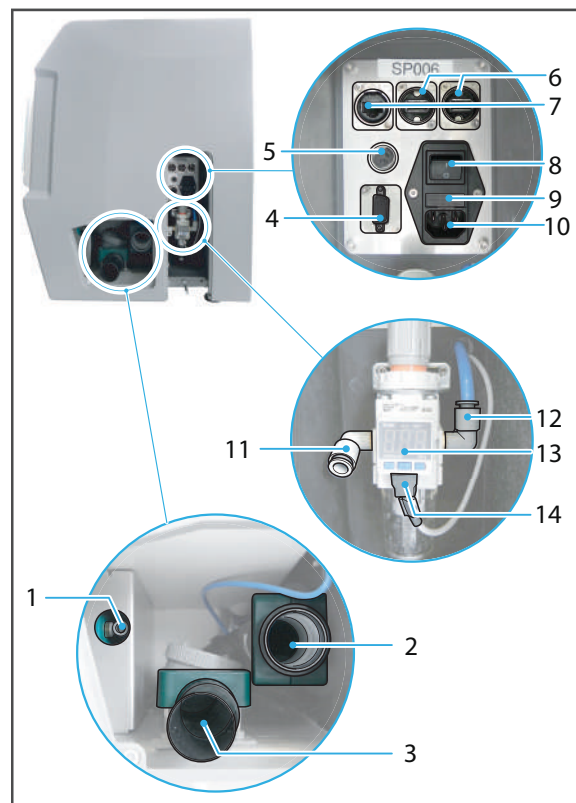

**!** If at a later time you need to disconnect the unit from the power supply, disconnect the plug from the wall socket, not from the device.

### 5.6 Connecting the device to the local network (LAN)

Your device supports Ethernet LAN. Connect to the local area network (LAN) which is required to operate the device within the PrograMill system.



Only use the supplied patch cable or the original spare part.

Your in-house technician or network administrator can help you configure and use LAN connections.

- ☑ The network connection is secured (in-house technician).
- ☑ The internet connection is secured (in-house technician).
- ☑ The communication between the devices in the PrograMill system and the corresponding CAM software "PrograMill CAM" is secured (distribution partner or Ivoclar Vivadent Digital Instructor).

1. Connect one end of the patch cable to the network connection (7) on the device.
2. Connect the other end of the patch cable to the network connection.

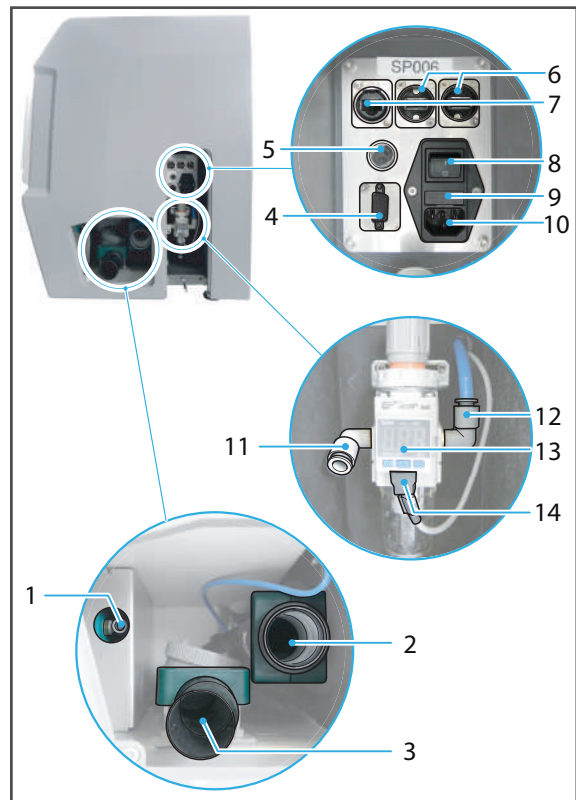

## 5.7 Switching the device on for the first time



Initial start-up of the device during installation is the same as any other time you will switch on the device.

When starting-up for the first time or after long standing phases the procedure may take a little more time.

- ☑ The transport protection is removed ("Removing the transport protection", page 46).
- ☑ The suction unit is connected ("Setting up and connecting the PrograMill Suction Unit or any other extraction system (can be ordered separately)", page 47).
- ☑ The PrograMill Tank and Filter are prepared and connected ("Preparing the PrograMill Tank and Filter and connecting to the device", page 48).
- ☑ The compressed air supply is connected ("Connecting the compressed air supply to the device", page 52).
- ☑ The device is connected to the power supply ("Connecting the device to the power supply", page 53).
- ☑ The device is connected to the local network ("Connecting the device to the local network (LAN)", page 54).
- ☑ All flaps on the device are closed.

1. Switch the on/off switch (8) from 0 to I.

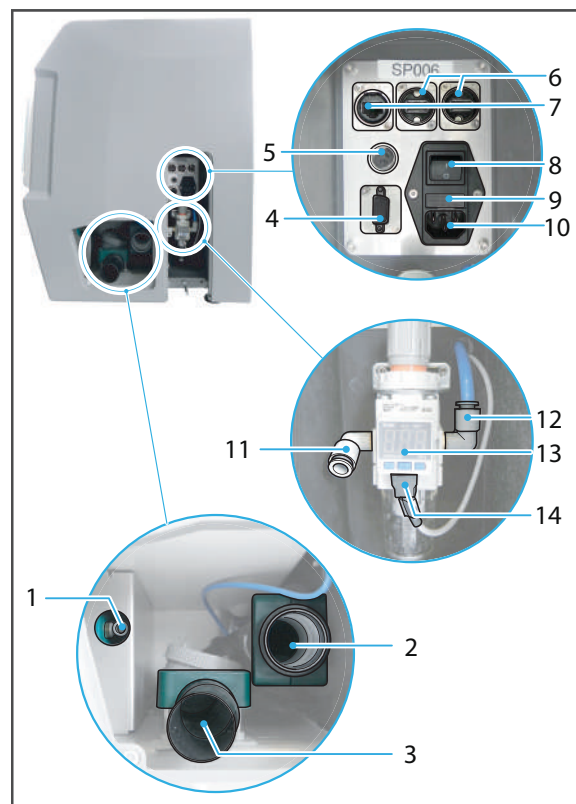

## Initial Operation

---

The start screen is displayed.

The flap status is checked (milling chamber, service flap, material changer). If one or more flaps are open then a corresponding message will appear ("Messages and warnings in the operating panel", page 144).

2. If one or more flaps are open, close them.

The compressed air supply is checked. If the compressed air supply is not connected, a corresponding message will appear.

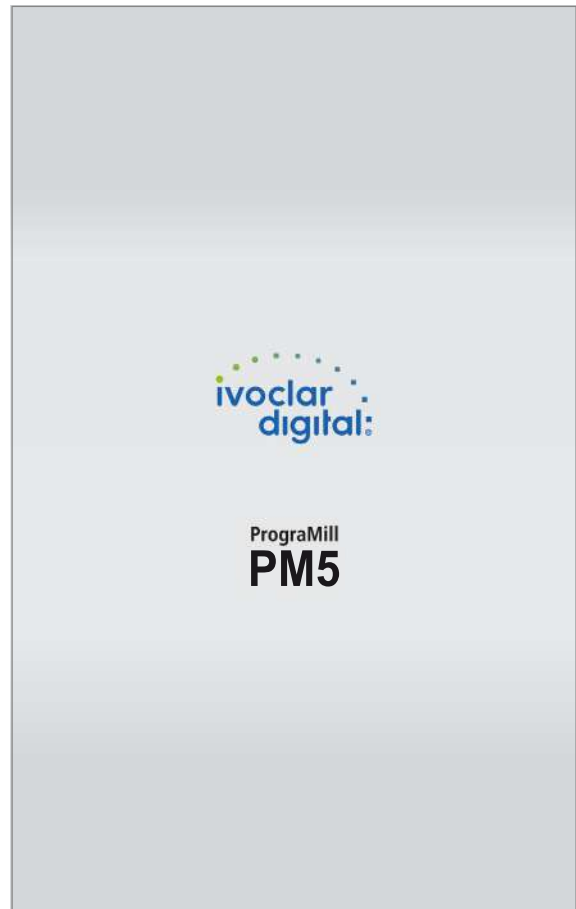



3. If the compressed air supply is not connected, connect and confirm with [Restart].

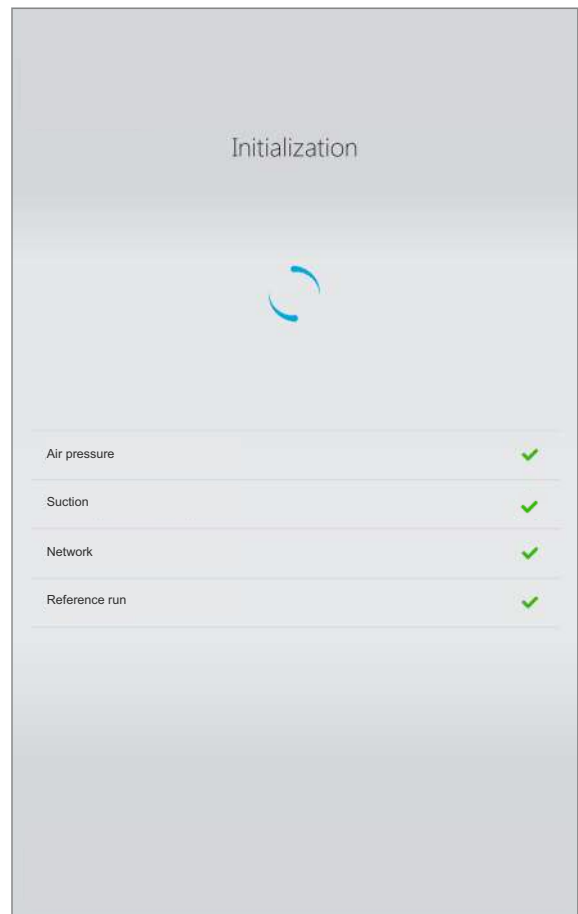

## Initial Operation

---

After checking the flap status and the compressed air supply, the device automatically performs several self-test steps (air pressure, filter status, network; it performs a reference run to position the axes).

After the self-test, the start screen display will appear.

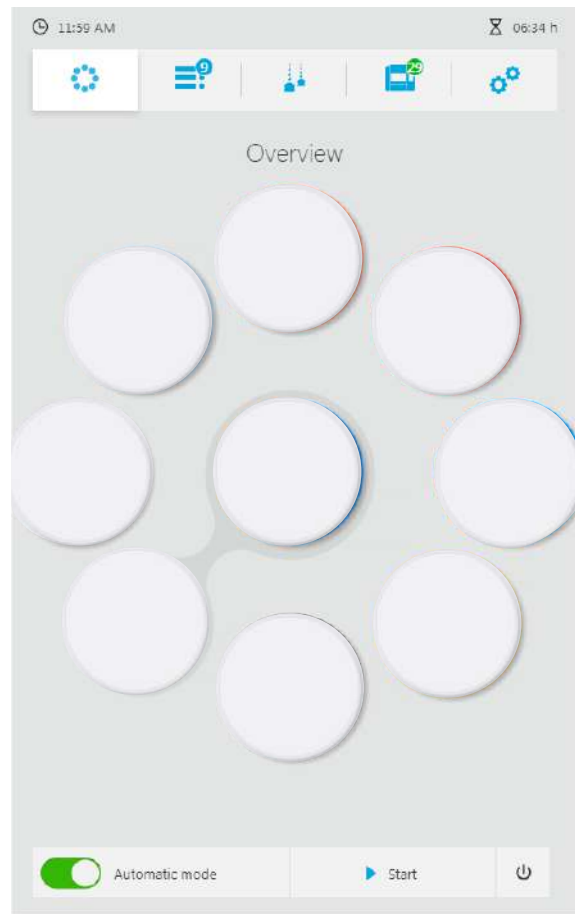

## 6 Operating the Operating Panel

The device is controlled exclusively via the operating panel on the touch screen.



The following illustrations may differ slightly from the software version installed on your device. Version-dependent functions are marked accordingly.

In order to ensure safe operation of your device, carry out the necessary software updates on a regular basis ("Showing software version and performing software update", page 90).

---

---

### **NOTICE! Connection of a virus-infected USB device to the machine.**

Damage to the machine. Data loss.

- ▶ Check the USB devices on a separate computer with a suitable anti-virus software before connecting them to the machine.
-

## 6.1 Overview of the control panel

The control panel consists of the following areas:

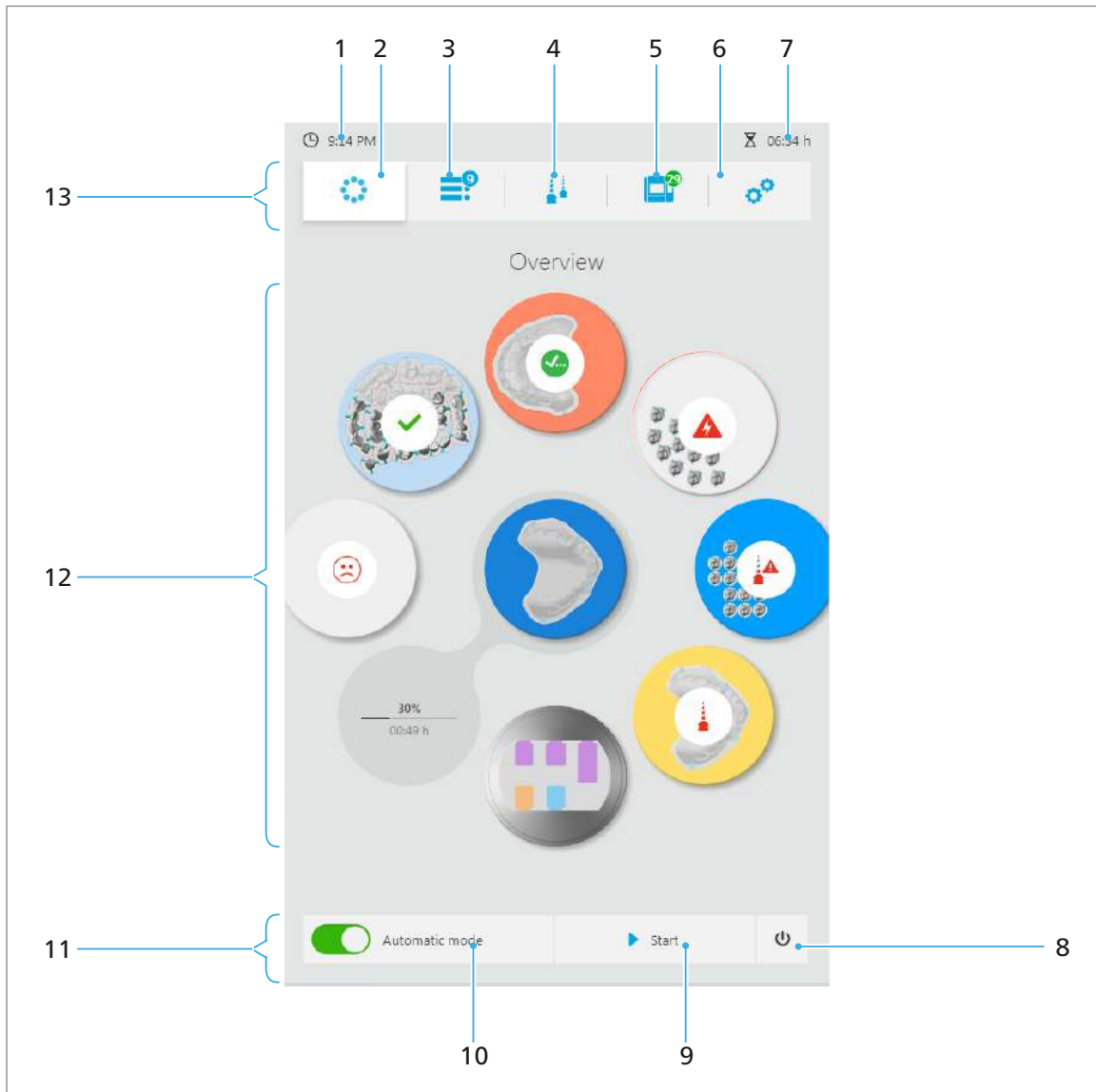







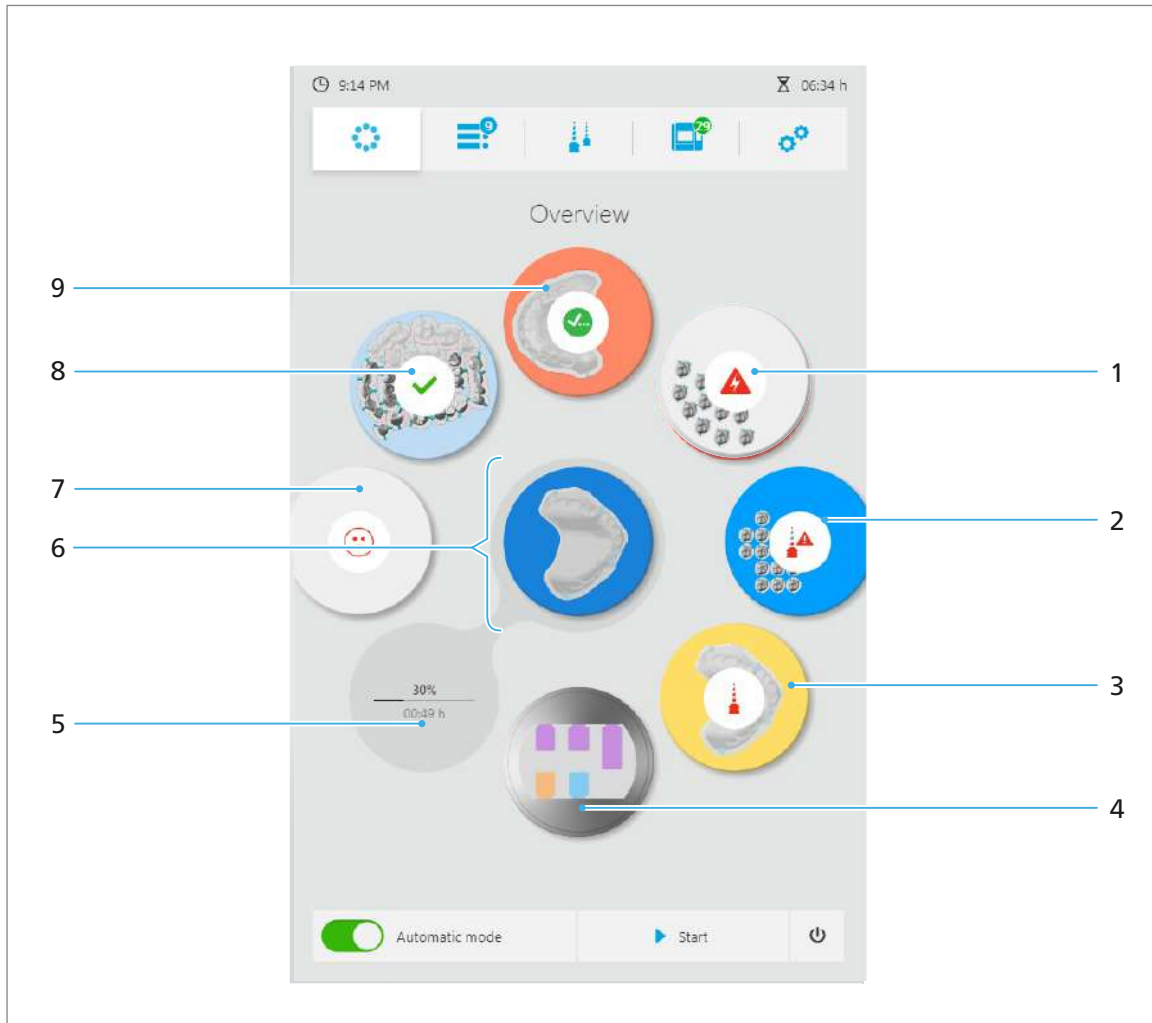

No.	Element	Description	Reference
1	Time	Current time	-
2	Main menu [Overview]	Start menu with block / disc holder management <ul style="list-style-type: none"> <li>• Disc or block status / material changer allocation / current jobs</li> <li>• Inserting discs / blocks</li> <li>• Removing discs / blocks / restorations</li> </ul>	"Main menu [Overview]", page 62
3	Main menu [Job list]	Status overview of milling jobs	"Main menu [Job list]", page 68

No.	Element	Description	Reference	
4	Main menu [Tools]	Tool manager: <ul style="list-style-type: none"> <li>• Management of magazines and tools</li> <li>• Unload current magazine with tools from the device.</li> <li>• Used Tool Library (library containing used tools)</li> <li>• Tool Library (library containing permitted tools)</li> </ul>	"Main menu [Tools]", page 1	
5	Main menu [Status]	Status overview machine, spindle, suction status, calibration status, device information, milling statistics, etc.	"Main menu [Status]", page 83	
6	Main menu [Settings]	<ul style="list-style-type: none"> <li>• Show software version</li> <li>• Set language</li> <li>• Set the touch screen brightness</li> <li>• Set time and date format</li> <li>• Log function</li> <li>• Service function (unlock front flap, restore coolant system, etc.)</li> </ul>	"Main menu [Settings]", page 86	
7	Milling duration	Total duration of the pending milling jobs	-	
8-11	Quick access bar (11)	Functions are displayed in all main menus:		
		8	"End" button: shut down the device	"Shutting the device down and switching it off", page 143
		9	[Start] / [Abort]: start the current milling job or abort the current milling job	"Stopping the milling process of the running milling job", page 133
		10	Switch the automatic mode off and then on again.	"Setting the milling mode (switching automatic mode on and off)", page 129
12	Main area	Main display area of the active menu	-	
13	Menu bar	Menu selection with the 5 main menus	-	

## 6.2 Main menu [Overview]

In the main menu [Overview] you can check the current status of all discs / block holders as well as running milling jobs at a glance.



No.	Element	Description		Reference
1	Disc or block status / messages	No symbol	All requirements for the milling job fulfilled. Milling job is running or can be started	"Starting the milling job", page 133
			Disc / block for milling job(s) missing	"Managing discs and blocks", page 111
			Tool for milling job/s missing	"Configuring and managing tool magazines and tools", page 1
			Milling job failed	"Device Messages and Troubleshooting", page 144
			Milling job successful (see pos. (8)), no further milling jobs available	"Finishing/ejecting a completed milling job", page 136
			Milling job successful, there are further milling jobs available for the disc / block.	
			Material not recognized	<ul style="list-style-type: none"> <li>"Troubleshooting / error table", page 150</li> <li>"Inserting the required discs and blocks", page 113</li> </ul>
			Tool defective / broken	<ul style="list-style-type: none"> <li>"Troubleshooting / error table", page 150</li> <li>"Removing unnecessary, worn or defective tools", page 104</li> </ul>
			Tool with too short tool service life for current job	"Removing unnecessary, worn or defective tools", page 104
2	Disc or block material	Colour coding indicates the disc / block material (PMMA, zirconium oxide, etc.). Settings are defined in the CAM software "PrograMil CAM".		-

## Operating the Operating Panel





No.	Element	Description	Reference
3	Disc or block holder for one or more pending milling jobs	<ul style="list-style-type: none"> <li>• Disc or block holder with at least one milling job that has not yet been processed</li> <li>• Tapping on individual disc or block holders: Display of a detailed view of the disc or block holder and the milling jobs assigned to it</li> </ul>	<ul style="list-style-type: none"> <li>• "Starting the milling job", page 133</li> <li>• "Detailed view of the disc or block holder and the milling jobs assigned to it", page 65</li> </ul>
4	Block holder IPS e.matrix	Block holder for processing multiple blocks	-
5	Milling time for running job	<ul style="list-style-type: none"> <li>• Above: Progress of running milling job (pos. (6)) in %</li> <li>• Below: Total milling time</li> </ul>	-
6	Disc or block holder for the current milling job	<ul style="list-style-type: none"> <li>• Disc or block holder of the milling job that is currently being processed</li> <li>• Tapping on individual disc or block holder: Display of a detailed view of disc or block holder and the milling jobs assigned to it</li> </ul>	"Detailed view of the disc or block holder and the milling jobs assigned to it", page 65
7	Free space	Unoccupied space in the material changer. At this position in the material changer, there is no disc or block holder with inserted disc / block	"Managing discs and blocks", page 111
8	Disc or block holder with at least one completed milling job	<ul style="list-style-type: none"> <li>• Job successfully completed and ready to unload</li> <li>• Tapping on individual disc or block holder: Display of a detailed view of disc or block holder and the milling jobs assigned to it</li> </ul>	-
9	Type of milling job	Preview of the restoration created with a milling job	-

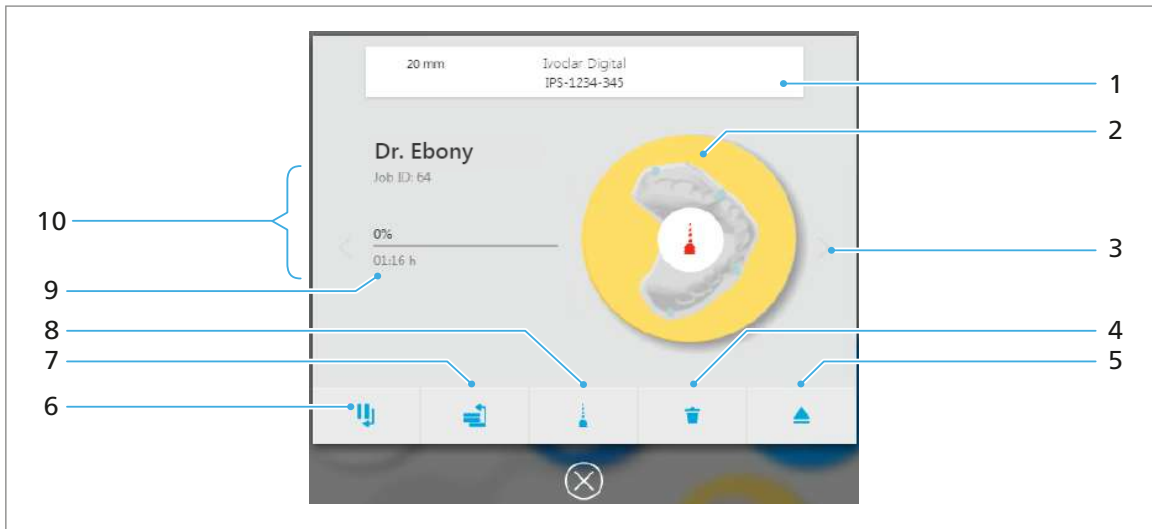

### 6.2.1 Detailed view of the disc or block holder and the milling jobs assigned to it

Tap the respective disc or block holder in the main menu [Overview] or the individual milling job in the main menu [Job list] to see a detailed view of the disc or block holder and its respective milling jobs. More than one milling job can be assigned to a disc or block holder.



No.	Element	Description	Reference
1	Label of the disc / block	Information on discs / blocks	-
2	Disc or block holder with milling jobs	Preview of restorations waiting to be milled in the disc or block holder and restorations already milled	-
3	Arrows	Changing between the milling jobs assigned to the disc / block holder (left, right)	-
4		Deleting the milling job. Not active for currently running job	"Deleting the milling job", page 130
5		Removing the disc / block (disc or block holder is moved into the removal/insertion position in the material changer). Not active for currently running job	"Managing discs and blocks", page 111
6		Pause the processing of the milling job after the current milling job.	"Pausing the processing of the milling jobs after the current milling job and then continuing again", page 134
7		Setting the milling job to the first position in the processing order. If a job is currently being processed, the milling job is allocated after this job.	"Specifying the sequence of milling jobs", page 131
8		Show tool for milling job (existing and still required). Not active for currently running job	See table

## Operating the Operating Panel

---



No.	Element	Description	Reference
9	Milling duration	<ul style="list-style-type: none"><li>• Above: Progress of the milling job in %</li><li>• Below: Total milling time</li></ul>	-
10	Milling job	Details of the individual milling job (customer name, patient name, etc.)	-

By tapping on the symbol, an overview of all tools required for the following job are displayed:

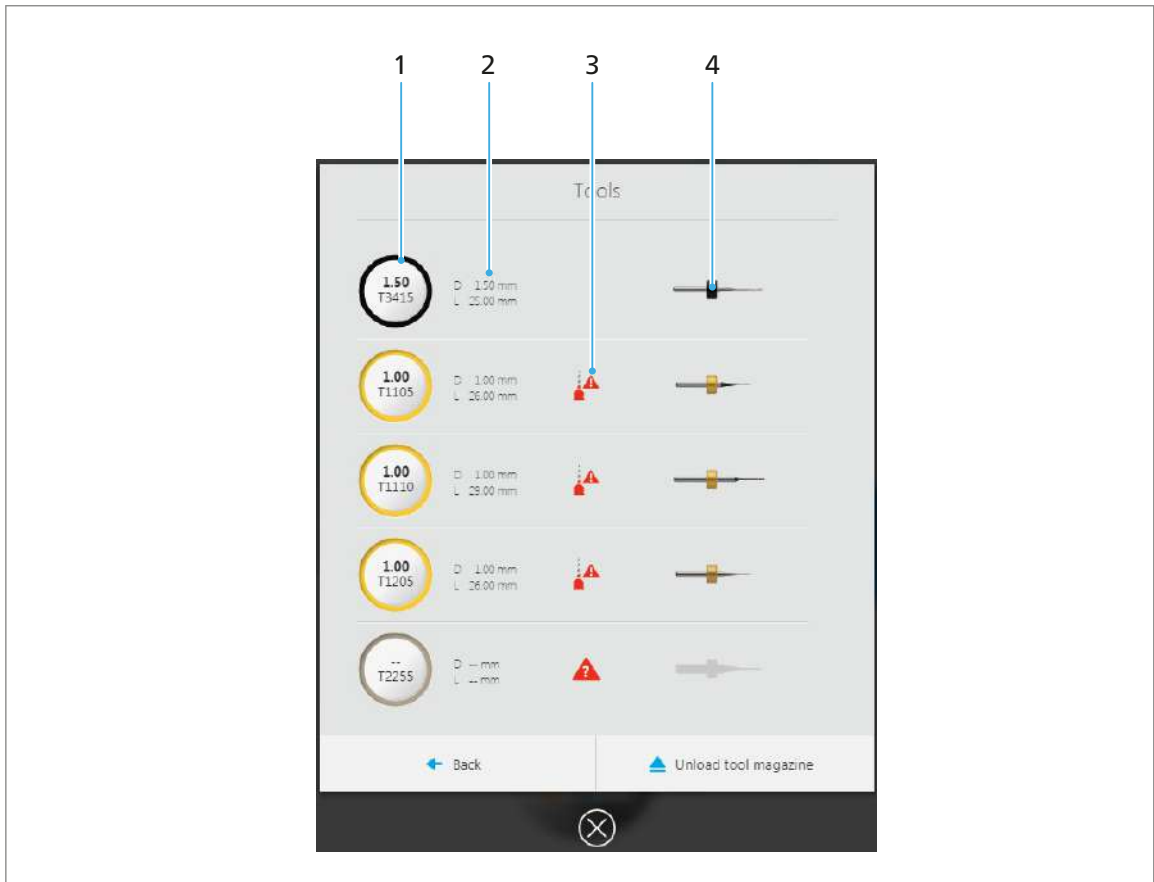

Each line displays information about a required tool.



No.	Element	Description	Reference	
1	Type of tool	Type of tool, item number	For more information on the tools, coding, etc., see "Main menu [Tools]", page 1	
2	Meta-information on tools	Diameter, length and service life of the tool		
3	Status	Information on the status of the tool		
		<table border="1"> <tr> <td>No symbol</td> <td>Required tool has been inserted</td> </tr> <tr> <td></td> <td>Required tool has not yet been inserted</td> </tr> </table>		No symbol
No symbol	Required tool has been inserted			
	Required tool has not yet been inserted			
4	Preview	Preview of the tool and its colour coding		

### 6.3 Main menu [Job list]

In the main menu [Job list], the milling jobs are managed on the milling machine.







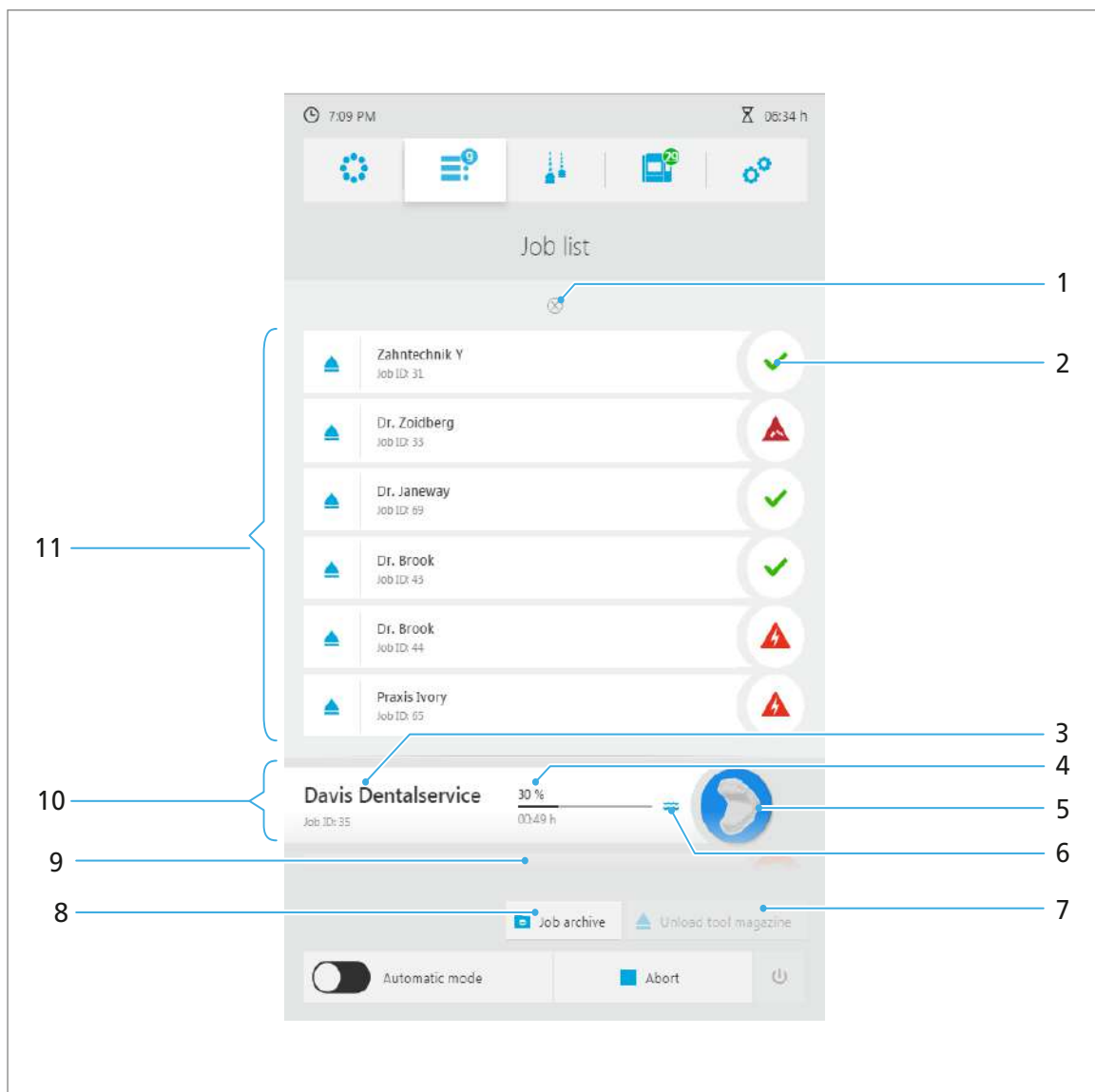

By default, processing is carried out chronologically which means in the order in which they were transferred from the CAM software "PrograMill CAM" to the milling machine: first milling job at the first position, second milling job at the second position, etc.

All the milling jobs transmitted by the CAM software "PrograMill CAM" to the milling machine are displayed as: running, pending and finished, but not yet actively completed by the user / ejected jobs.

Deleted, archived and failed milling jobs are displayed in the Job Archive ("Sub-menu [Job archive]" (depends on version)", page 71).



Tap the respective disc or the block holder to see a detailed view of the disc or the block holder and the milling jobs assigned to it ("Detailed view of the disc or block holder and the milling jobs assigned to it", page 65).

No.	Element	Description	Reference	
1	Show completed milling jobs	Open list of completed, not yet ejected milling jobs (in the closed position, only a selection of the jobs is displayed)	<ul style="list-style-type: none"> <li>“Finishing/ejecting a completed milling job”, page 136</li> <li>“Displaying the Job Archive (depends on version)”, page 142</li> </ul>	
2	Job status (example: successfully completed milling job, compared to not completed milling job, pos. (5))	No symbol	All requirements for the milling job fulfilled. Milling job is running or can be started.	“Starting the milling job”, page 133
			Disc / block for milling job(s) missing	“Managing discs and blocks”, page 111
			Tool for milling job(s) missing	“Configuring and managing tool magazines and tools”, page 1
			Milling job failed	“Device Messages and Troubleshooting”, page 144
			Milling job successful	“Finishing/ejecting a completed milling job”, page 136
			Milling job successful, there are further milling jobs available for the disc / block.	
			Material not recognized	<ul style="list-style-type: none"> <li>“Troubleshooting / error table”, page 150, section “Disc / block not found”</li> <li>“Inserting the required discs and blocks”, page 113</li> </ul>
			Tool defective / broken	<ul style="list-style-type: none"> <li>“Troubleshooting / error table”, page 150, section “Tool broken”</li> <li>“Removing unnecessary, worn or defective tools”, page 104</li> </ul>
			Tool with too short tool service life for current job	“Removing unnecessary, worn or defective tools”, page 104

## Operating the Operating Panel

No.	Element	Description	Reference	
3	Details of the milling job (running milling job as an example)	<ul style="list-style-type: none"> <li>Above: Customer name With red marking: Tool or disc / block missing</li> <li>Below: Job ID from PrograMill CAM</li> </ul>	-	
4	Milling duration for running job	<ul style="list-style-type: none"> <li>Above: Progress of the milling job in %</li> <li>Below: Total milling time</li> </ul>	-	
5	Type of milling job (running milling job as an example)	<ul style="list-style-type: none"> <li>The preview shows which restoration is created with the milling job</li> <li>Tapping on individual discs or the block holder: Display of a detailed view of disc or block holder and the milling jobs assigned to it</li> <li>Possible symbols on the milling job correspond to symbols under pos. (2)</li> </ul>	"Detailed view of the disc or block holder and the milling jobs assigned to it", page 65	
6	Type of milling (wet or dry milling)	No symbol	Dry operation / dry milling	-
			Wet operation / wet milling	
7	Key [Unload tool magazine]	Unload tool magazine to change or replace tool	"Configuring and managing tool magazines and tools", page 1	
8	Key [Job archive]	Request Job Archive (depends on version)	"Sub-menu [Job archive] (depends on version)", page 71	
9	Pending milling jobs	List of pending, not yet processed milling jobs	"Preparing milling jobs", page 127	
10	Active / running milling job	Details of the individual milling job	<ul style="list-style-type: none"> <li>See pos. (2) to (4)</li> <li>Tap: Request detailed view, "Detailed view of the disc or block holder and the milling jobs assigned to it", page 65</li> </ul>	
11	Completed / failed milling jobs	Currently completed or failed, not yet ejected milling jobs (open complete list, see pos. (1) + (2))	"Finishing/ejecting a completed milling job", page 136	

### 6.3.1 Sub-menu [Job archive] (depends on version)



---

It depends on the software version installed on your device whether your operating panel has this function or not.

---

By tapping the key [Job archive], you can display all already processed milling jobs. Both successful and failed milling jobs will be displayed. It is not possible to restart failed milling jobs in this view.

You can sort the milling jobs according to:

- Date (tab [Date])
- Status (tab [Status])
- Processing duration (tab [Time])
- Client (tab [Client])



---

The elements described below are identical in all four views.

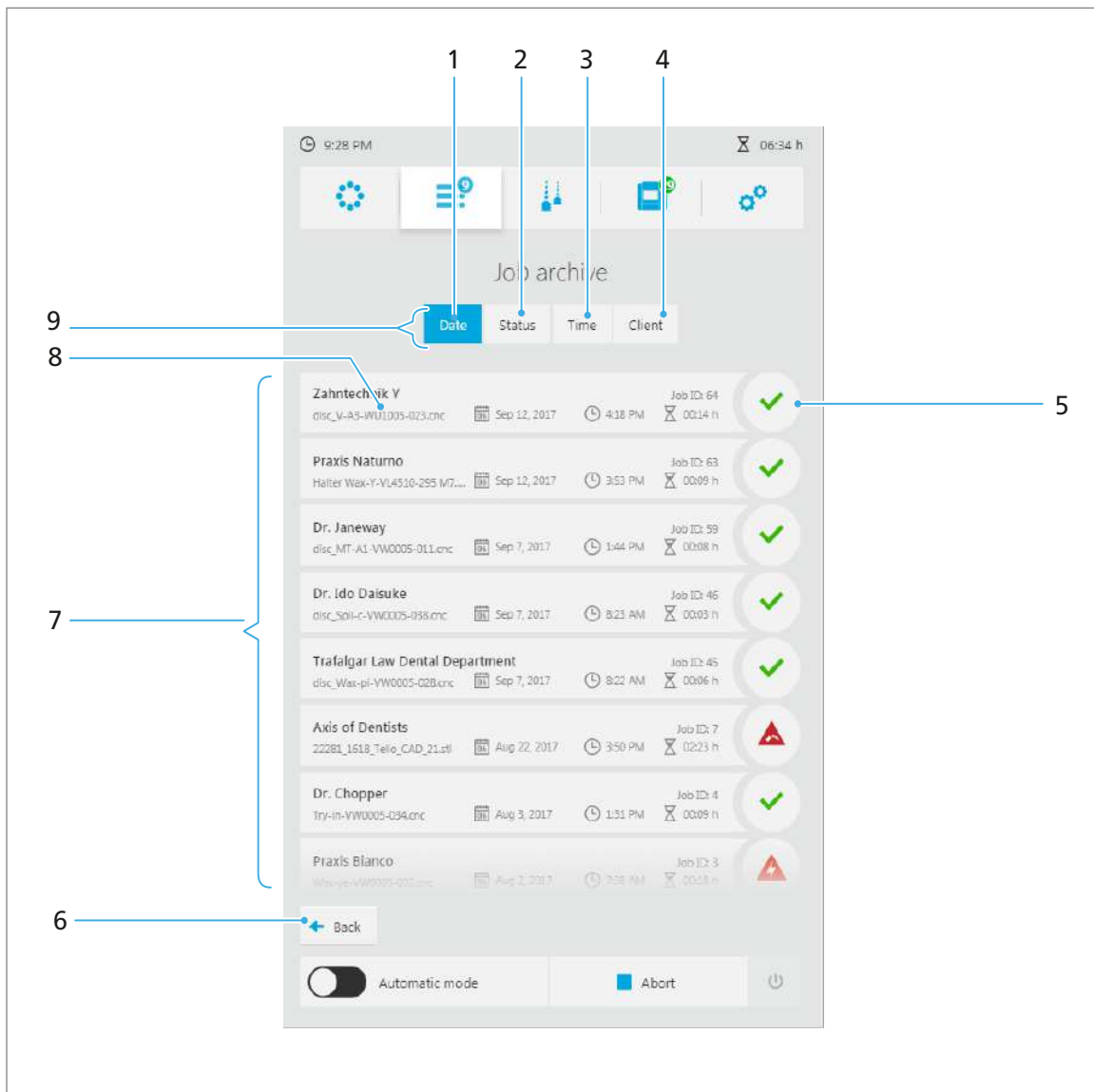

---

## Operating the Operating Panel



No.	Element	Description	Reference
1	Tab [Date]	View completed milling jobs sorted by date	-
2	Tab [Status]	View completed milling jobs sorted by status	-
3	Tab [Time]	View completed milling jobs sorted by processing duration	-
4	Tab [Client]	View completed milling jobs sorted by client	-



No.	Element	Description	Reference
5	Status	 Milling job failed	"Device Messages and Troubleshooting", page 144
		 Milling job successful	"Finishing/ejecting a completed milling job", page 136
		 Tool defective / broken	<ul style="list-style-type: none"> <li>"Troubleshooting / error table", page 150, section "Tool broken"</li> <li>"Removing unnecessary, worn or defective tools", page 104</li> </ul>
6	Key [Back]	Return to the [Job list] view with active / running milling jobs	-
7	Archived milling jobs	List of all completed milling jobs	-
8	Details of the milling job	<ul style="list-style-type: none"> <li>Above: Customer name</li> <li>With red marking: Milling job failed</li> <li>Below: Job ID from PrograMill CAM</li> </ul>	-
9	Sub-menus	Select the sorting type required for archived milling jobs (pos. 1-4)	-



## 6.4 Main menu [Tools]

In the main menu [Tools] the tool magazines for the milling machine are managed.

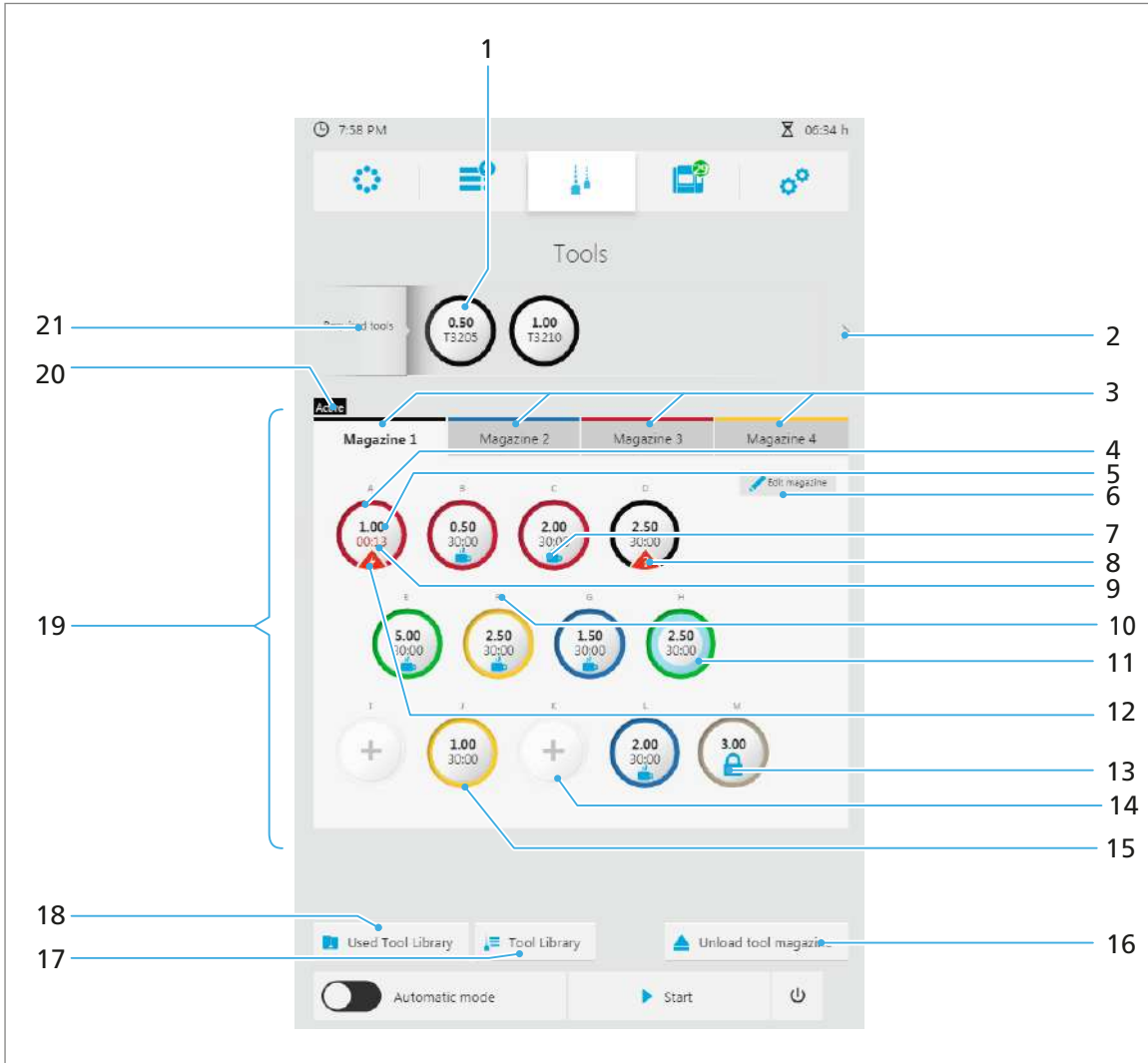
For efficient work, we recommend that you use a separate magazine with several redundant tools for each material (up to 4 magazines configurable).



No.	Element	Description	Reference
1	Required tools	A tool required for the milling jobs	-
2	Arrow	View other required tools	-
3	Tab for the defined magazines	Overview of the defined tool magazines (max. 4 magazines with 13 tool spaces each)	"Configuring and managing tool magazines and tools", page 1

No.	Element	Description	Reference
4	Full magazine slot	<ul style="list-style-type: none"> <li>Magazine slot with inserted tool in the tool magazine</li> <li>By tapping the display, a detailed view of the individual slot and the tool in it is shown.</li> </ul>	<ul style="list-style-type: none"> <li>"Detailed view of individual magazine slots / tools in the magazine slot", page 78</li> <li>"Removing unnecessary, worn or defective tools", page 104</li> </ul>
5	Type of tool	Information which tool type / which milling tool is inserted (e.g. 2.0 D)	-
6	Symbol [Edit magazine]	Rename magazine / assign a name to the magazine	-
7		Tool is inserted and configured. It is not required for any of the pending milling jobs.	-
8	Warning message 	Tool could not be identified (e.g. after power failure). The slot must be reallocated/ reconfigured.	"Using new tools and configuring a tool magazine", page 98
9	Tool service life	Information on how many milling hours the tool has already been in use: <ul style="list-style-type: none"> <li>Service life black: Tool service life is satisfactory</li> <li>Service life red: Max. service life is reached, the tool must be changed</li> </ul>	<ul style="list-style-type: none"> <li>"Using new tools and configuring a tool magazine", page 98</li> <li>"Removing unnecessary, worn or defective tools", page 104</li> </ul>
10	Identification (ID) of the magazine slot	-	-
11	Tool status	Tool is currently being used	-
12	Warning message 	Tool defective or maximum tool life is reached. Tool must be exchanged with a new tool.	"Device Messages and Troubleshooting", page 144
13	Pre-occupied slot M	Dummy tool (shaft with ring)	-

## Operating the Operating Panel

No.	Element	Description	Reference
14	Empty magazine slot	<ul style="list-style-type: none"> <li>• Empty slot in the tool magazine</li> <li>• Tap on the empty slot: Open dialogue for inserting a tool</li> </ul>	<ul style="list-style-type: none"> <li>• "Detailed view of the disc or block holder and the milling jobs assigned to it", page 65</li> <li>• "Using new tools and configuring a tool magazine", page 98</li> </ul>
15	Colour ring	Information for which material the tool is suitable for: <ul style="list-style-type: none"> <li>• yellow: Zirconium oxide</li> <li>• green: PMMA</li> <li>• red: IPS e.max / Empress</li> <li>• black: Wax</li> <li>• blue: NP (CoCr) / Ti</li> </ul>	-
16	Key [Unload tool magazine]	Unload tool magazine to change or replace a tool	<ul style="list-style-type: none"> <li>• "Using new tools and configuring a tool magazine", page 98</li> <li>• "Removing unnecessary, worn or defective tools", page 104</li> </ul>
17	Key [Tool Library]	Library containing approved tools	"Sub-menu [Tool Library]", page 82
18	Key [Used Tool Library]	Library containing used tools	"Sub-menu [Used Tool Library]", page 80
19	Active tool magazine	Overview of the respective tool magazine and its slots	"Detailed view of individual magazine slots / tools in the magazine slot", page 78
20	Display [Active]	Identification of the active tool magazine used in the device. The last configured tool magazine is automatically assigned the status [Active].	-
21	Required tools	List of all tools required for milling jobs	"Configuring and managing tool magazines and tools", page 1

### 6.4.1 Dialogue for inserting tools into an empty magazine slot

By tapping an empty slot in the tool magazine the following dialogue for inserting a tool into a slot is displayed:

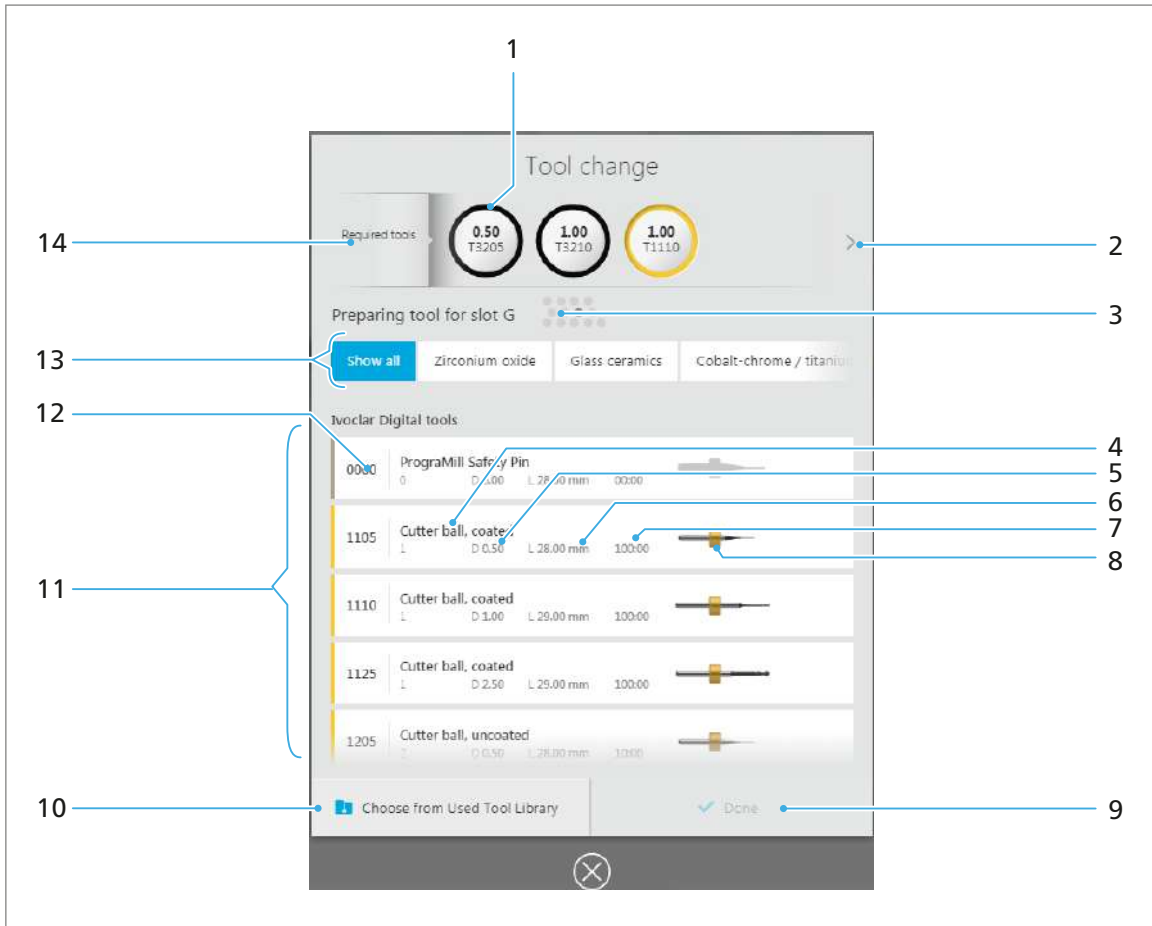

No.	Element	Description	Reference
1	Required tools	A tool required for the milling jobs	-
2	Arrow	View other required tools	-
3	Slot	Selected slot for the tool in the tool magazine	-
4	Tool name	Tool description	-
5	Diameter	Tool diameter	-
6	Length	Tool length	-
7	Service life	Estimated tool service life	-
8	Preview	Preview of the tool and its colour coding	-
9	Key [Done]	Confirm the selected tool and return to the main menu [Tools]	-

## Operating the Operating Panel

No.	Element	Description	Reference
10	Key [Choose from Used Tool Library]	Show Used Tool Library in order to insert a used tool which is currently not in a magazine, instead of using a completely new tool	"Sub-menu [Used Tool Library]", page 80
11	Ivoclar Digital tools	List of approved Ivoclar Digital tools for the selected material	-
12	Tool ID	ID of the tool	-
13	Types of materials	Show tools only for a particular material	-
14	Required tools	List of all tools required for milling jobs	"Configuring and managing tool magazines and tools", page 1

### 6.4.2 Detailed view of individual magazine slots / tools in the magazine slot

By tapping on an occupied slot in the tool magazine, the following detailed view with information on the slot and the inserted tool is displayed:

Original tools from Ivoclar Vivadent:

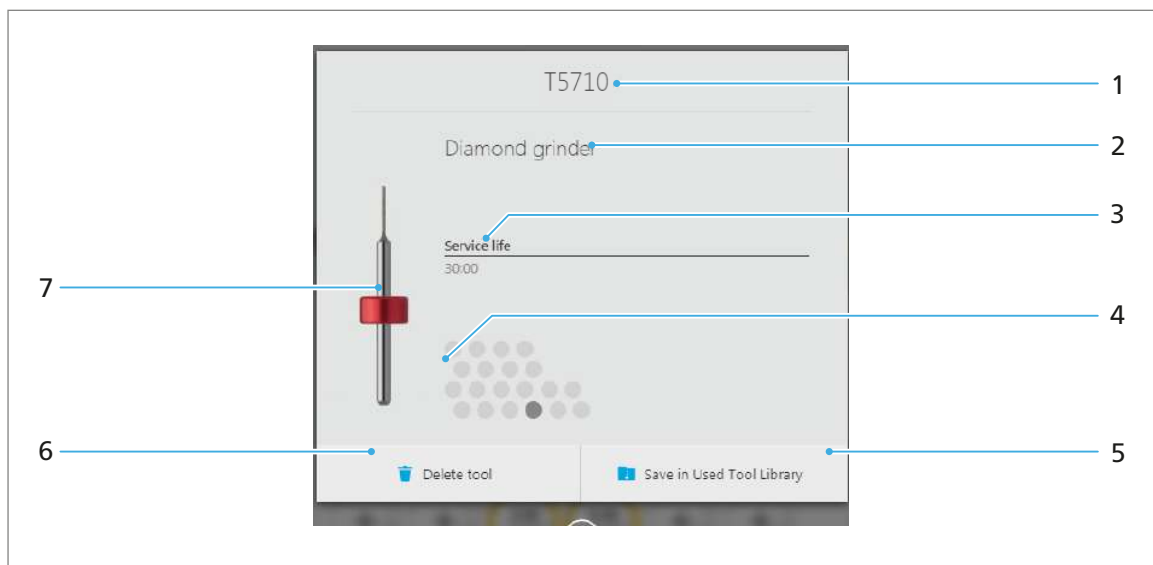

No.	Element	Description	Reference
1	Tool ID	ID of the tool	-
2	Tool name	Tool designation	-
3	Service life	Actual tool service life	-
4	Slot	Slot where the indicated tool is located in the tool magazine	-
5	Key [Save in Used Tool Library]	Place the unwanted, but intact tool in the Used Tool Library for later re-use and release the tool slot in the tool magazine	"Removing unnecessary, worn or defective tools", page 104
6	Key [Delete tool]	Delete worn or defective tool from the system and release the tool slot in the tool magazine	
7	Preview	Preview of the tool and its colour coding	-

Manually selected non-Ivoclar Digital tool:

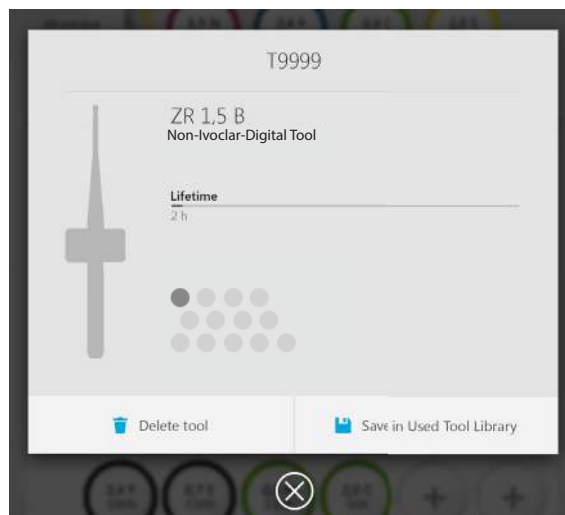

### 6.4.3 Sub-menu [Used Tool Library]

Tap the [Used Tool Library] key to display the library of used tools (Used Tool Library, "Working with the Used Tool Library", page 110). Alternatively, the Used Tool Library is displayed when you select the key [Choose from Used Tool Library] in the dialogue for inserting tools in an empty magazine slot. You can then insert an already used tool into a magazine ("Detailed view of the disc or block holder and the milling jobs assigned to it", page 65).

The optionally available cabinet PrograMill Base is built with a standard storage solution for the tools in the Used Tool Library (container "Used Tool Library for PM3/5/7", "Delivery form", page 1). The description of the positions in the operating panel (pos. (1) and (6)) corresponds to the identification matrix of this container so that all you need to do is to place the tool in the appropriate slot in the container after removal.

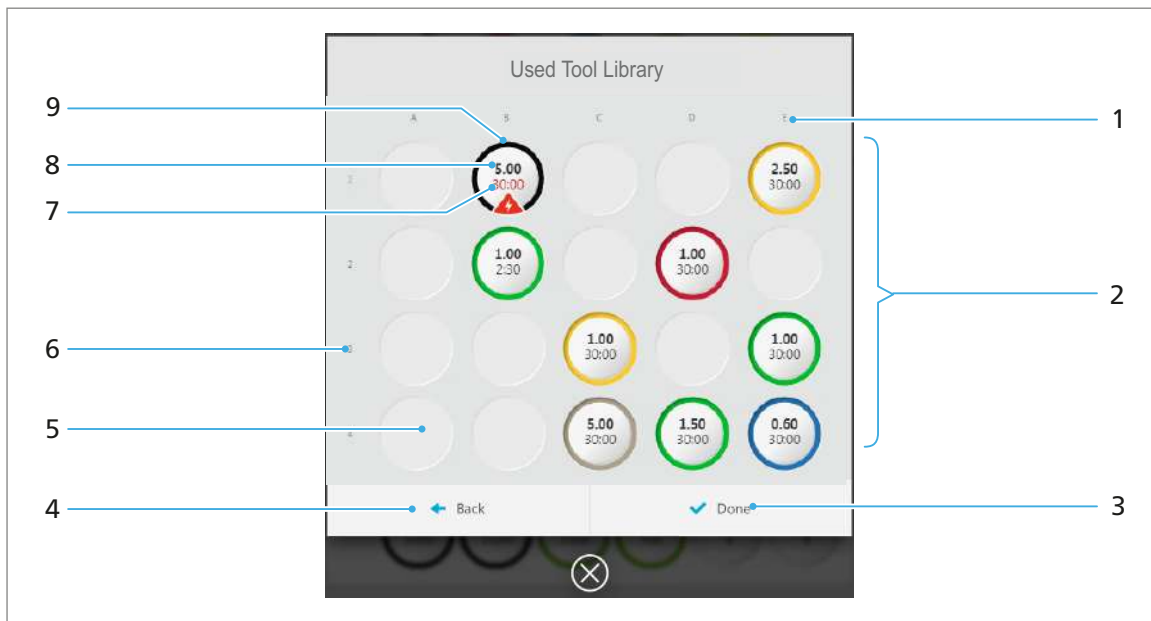

No.	Element	Description	Reference
1	Horizontal space definition	Pos. (1) and pos. (6) together form the clear definition of spaces present in the Used Tool Library on the operating panel (A1 to E4). This definition corresponds with the actual container "Used Tool Library for PM3/5/7" within the PrograMill Base cabinet.	-
2	Allocation	Overview of all free and occupied spaces in the Used Tool Library	-
3	Key [Done]	When inserting a tool into a magazine: Confirm selected tool and insert into magazine.	"Dialogue for inserting tools into an empty magazine slot", page 77
4	Key [Back]	Go back to main menu [Tools].	-
5	Empty space in the Used Tool Library	-	-



No.	Element	Description	Reference
6	Vertical space definition	Pos. (1) and pos. (6) together form the clear definition of spaces present in the Used Tool Library on the operating panel (A1 to E4). This definition corresponds with the actual container "Used Tool Library for PM3/5/7" within the PrograMill Base cabinet.	-
7	Service life	Estimated tool service life	-
8	Type of tool	Information which tool type / which milling tool is inserted (e.g. 1.5)	-
9	Occupied space in the Used Tool Library	Information about which tool is located at the relevant space in the occupancy matrix (example: A1)	-



Unused tool magazines can also be stored in the PrograMill Base cabinet.

---

### 6.4.4 Sub-menu [Tool Library]

By tapping the [Tool Library] key, the library of all the original PrograMill tools approved by Ivoclar Vivadent will be shown. In addition, non-Ivoclar Digital tools can be defined.

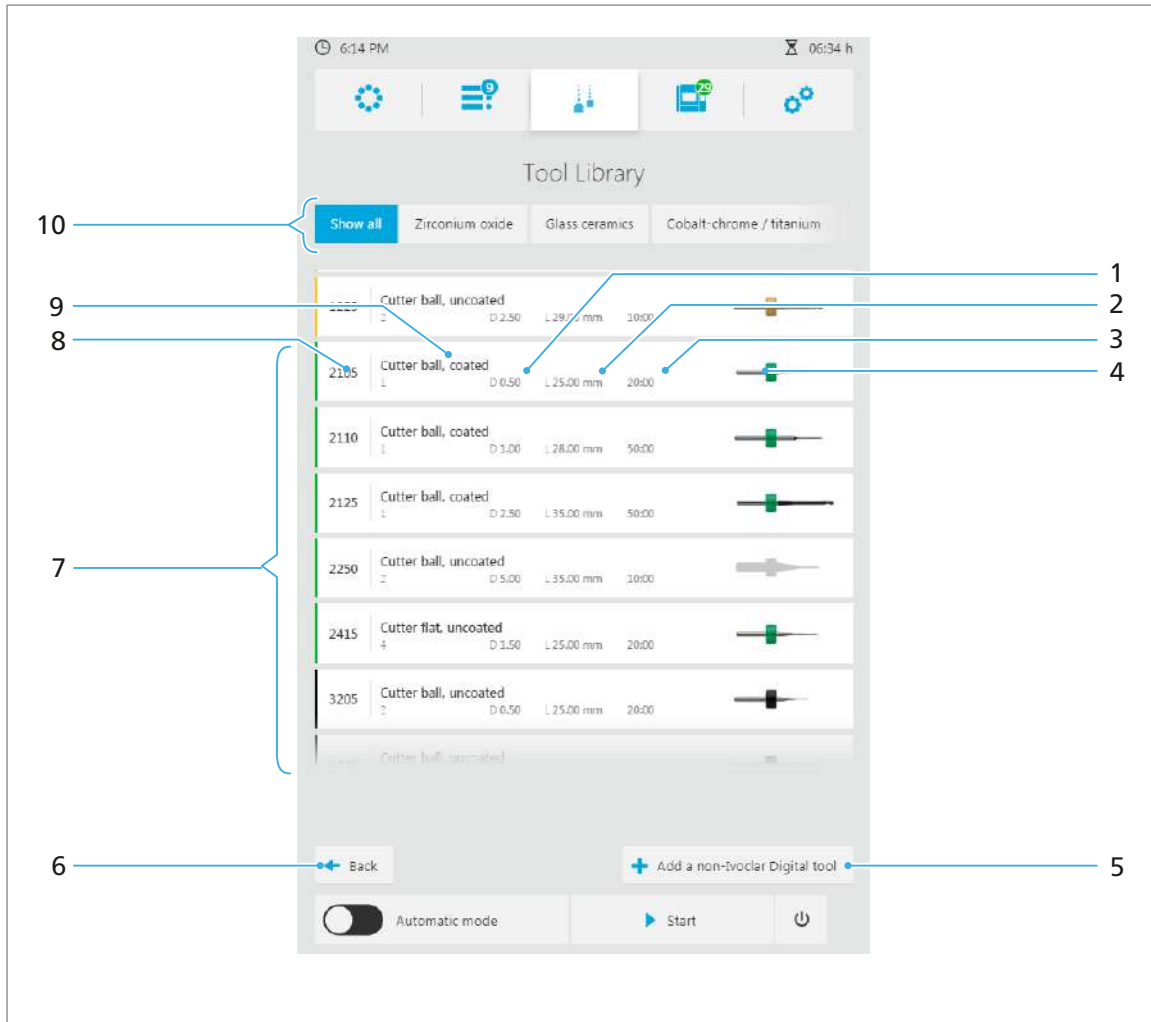

No.	Element	Description	Reference
1	Diameter	Tool diameter	-
2	Length	Tool length	-
3	Service life	Estimated tool service life	-
4	Preview	Preview of the tool and its colour coding	-
5	Key [Add a non-Ivoclar Digital tool]	Add a tool from another manufacturer	"Defining non-Ivoclar Digital tools", page 108
6	Key [Back]	Go back to main menu [Tools].	-
7	Ivoclar Digital tools	List of approved Ivoclar Digital tools for the selected material	-
8	Tool ID	ID of the tool	-

No.	Element	Description	Reference
9	Tool name	Tool designation	-
10	Type of material	Sorting the tools according to the type of material	-

### 6.5 Main menu [Status]

In the main menu [Status] you can see the following information:

- Milling information
- Machine data, e. g. suction unit data
- Machine and milling statistics, e. g. operating hours
- Alert messages and notifications

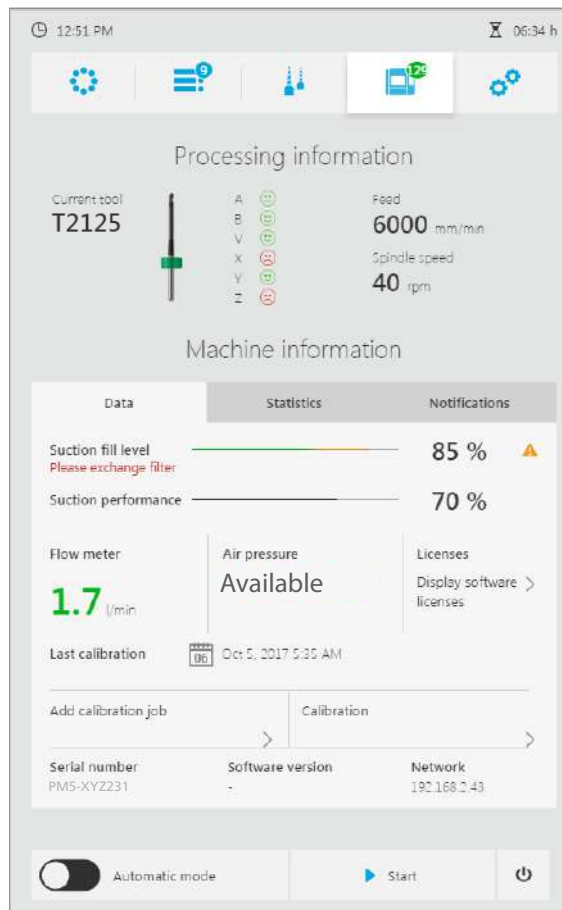

### 6.5.1 Section [Processing information]

In the section [Processing information] the following information is shown (from left to right, "Displaying current milling information", page 88):

- Name of the tool currently in use
- Preview of the tool and its colour coding
- Axes status (Smileys)
- Feed / spindle speed



### 6.5.2 Tab [Data]

In the tab [Data], all machine data, e. g. suction unit data, air pressure data, calibration status etc. are shown ("Tab [Data]", page 84).

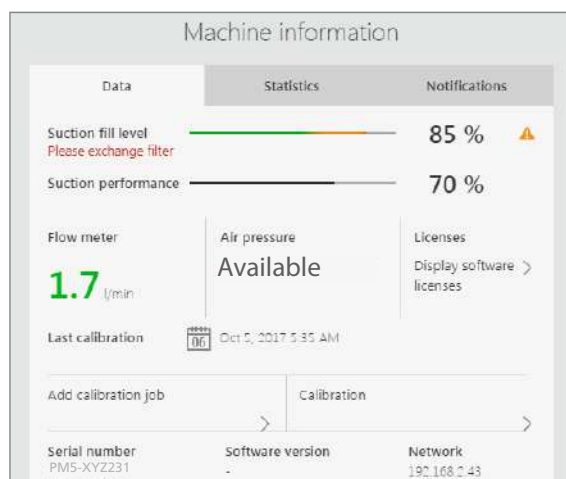

Element	Description
Suction fill level	Filter fill level statistics in the PrograMill Suction Unit
Suction performance	PrograMill Suction Unit performance level (3 levels, device selects automatically)
Flow meter	Volume flow meter of coolant liquid
Air Pressure	Status of the air pressure supply
Licences	Software licences
Last calibration	Information about the last calibration of the device
Add calibration job	Perform new cablibration
Calibration	Evaluate calibration
Serial number	Serial number of the machine
Software version	Software version of the operating panel

Element	Description
Network	IP address of the machine

### 6.5.3 Tab [Statistics]

The tab [Statistics] shows machine and milling statistics, e. g. operating hours, wet and dry milling etc., (“Displaying and editing notifications and error messages”, page 89).

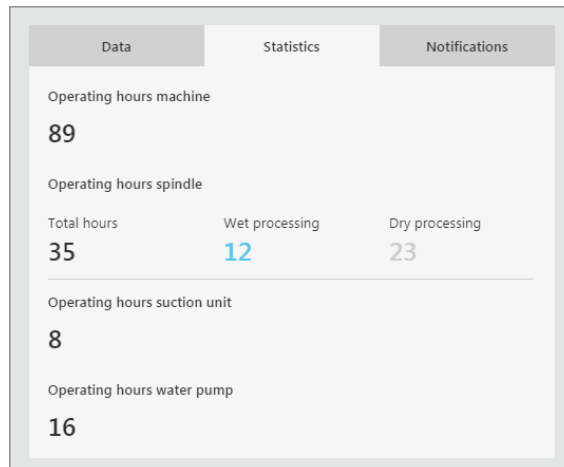

Element	Description
Operating hours machine	Machine operating hours (total)
Operating hours spindle	Spindle operating hours (total, wet operation, dry operation)
Operating hours suction unit	Operating time PrograMill Suction Unit
Operating hours water pump	Water pump operating hours

## Operating the Operating Panel

### 6.5.4 Tab [Notifications]

In the tab [Notifications] you can view and confirm notifications and error messages (“Displaying and editing notifications and error messages”, page 89).

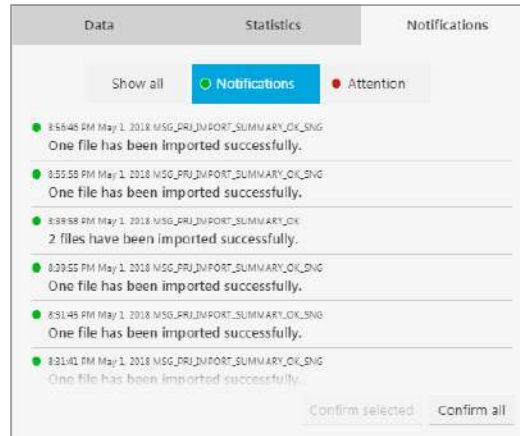

### 6.6 Main menu [Settings]

In the main menu [Settings], you can perform various configurations and presets for your device.

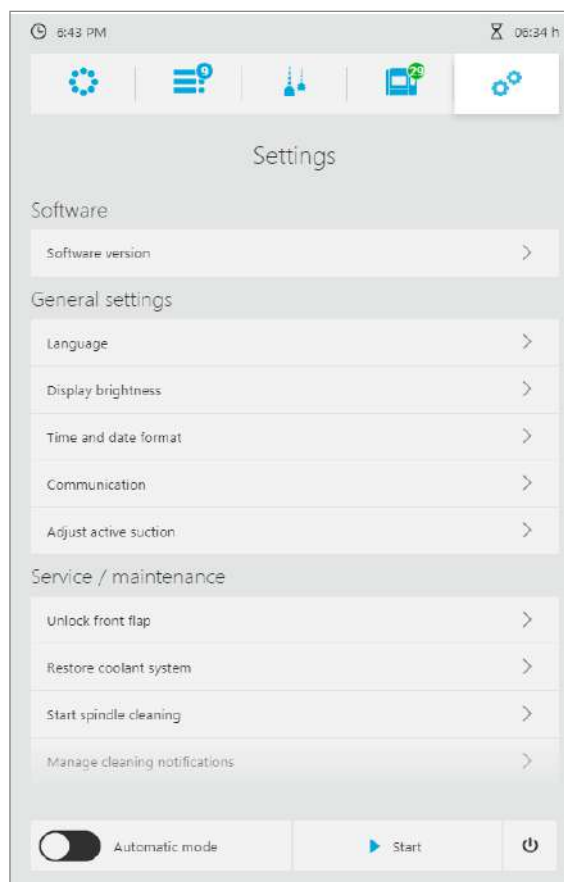

Section	Menu	Description	Reference
Software	Software version	Show software version and perform update	"Showing software version and performing software update", page 90
General settings	Language	Set the operating panel language	"Setting the operating panel language", page 91
	Display brightness	Set the brightness of the touchscreen	"Setting touch screen brightness", page 91
	Time and date format	Set time zone and date format	"Setting the time zone and date format", page 92
	Communication	Activate / deactivate protocols, notifications of updates on the machine etc.	"Activating / deactivating the communication function", page 92
	Adjust active suction	Activate / deactivate connected suction	"Activate / deactivate the active suction", page 93
Service / maintenance	Unlock front flap	Unlock front flap manually	"Unlocking the front flap", page 93
	Restore coolant system	After tank cleaning and filter change start the coolant system again	"Restoring the coolant system", page 94
	Start spindle cleaning	Preparing the device for cleaning the collet	"Cleaning the collet", page 164
	Manage cleaning notifications	Display cleaning messages in the user interface or deactivate display	"Managing cleaning notifications", page 94

# 7 Making General Setting Changes in the Operating Panel

## 7.1 Viewing and editing device status

To display detailed information about the device, proceed as described in the following sections.

### 7.1.1 Displaying current milling information

To show milling information from a running milling job (e.g. tools used, axis information, milling speed), proceed as follows:

- ▶ Tap on the symbol: 
- ➔ The milling information for the running milling job will be displayed ("Section [Processing information]", page 84).

### 7.1.2 Viewing and editing device data

To show machine data and if necessary edit the data (e.g. suction unit data, air pressure data, cleaning status), proceed as follows:

1. Tap on the symbol:   
The tab [Data] shows the machine data ("Tab [Data]", page 84).
2. To show additional information or functions, tap the arrow next to the desired area: >

### 7.1.3 Displaying machine and milling statistics

To show machine and milling statistics (e.g. operating hours, wet and dry milling), proceed as follows:

1. Tap on the symbol: 
  2. Tap on tab [Statistics].
- ➔ The machine and milling statistics will be displayed ("Tab [Statistics]", page 85).



### 7.1.4 Displaying and editing notifications and error messages

In order to display notifications and error messages from the ongoing operation, proceed as follows:

1. Tap on the symbol: 

2. Tap on the tab [Notifications].

The notifications and error messages will be displayed, sub-divided according to [Show all], [Notifications] and [Attention].

3. Click on the desired tab.

4. Confirm and delete all messages with [Confirm all].

– or –

Select an individual message and confirm and delete it with [Confirm selected].

### 7.2 Changing settings

In the main menu [Settings] you can change various settings (“Main menu [Settings]”, page 86).

#### 7.2.1 Showing software version and performing software update

---

##### **NOTICE! Incomplete software update.**

Data loss.

- ▶ Perform a data base back-up before a software update. For that purpose, please contact your authorized service partner.
- 

To display the current version of the operating panel and if necessary, perform an update, proceed as follows:

- All active milling jobs have been successfully completed.
- You are in the main menu [Settings].

1. Select [Software version] in the menu.  
The software version will be displayed.

2. To install an existing software update, tap [Load and install].  
The software update will be downloaded.

After a successful download, the software update will be installed.

After successful installation, a corresponding message will appear.

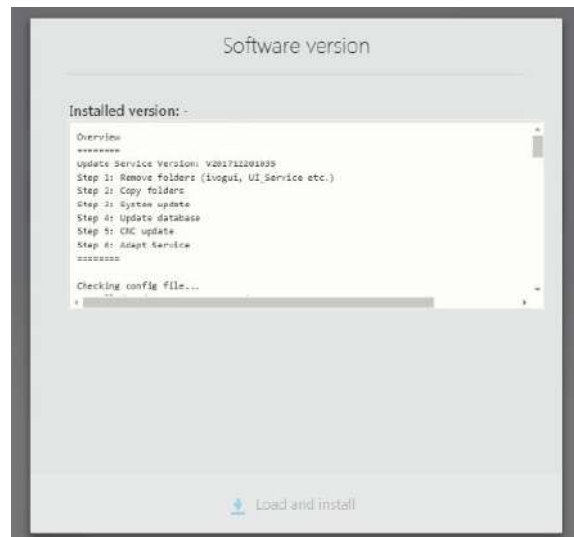

Carry out a restart of the milling machine if asked to do so.

---

3. To carry out a restart, tap on the [Restart] tab.

- ➔ The milling machine will restart.
- ➔ The software update will take effect.

### 7.2.2 Setting the operating panel language

To set the operating panel language, proceed as follows:

- ☑ You are in the main menu [Settings].
- 1. Select [Language] in the menu.  
The list of available languages will be displayed.
- 2. Tap on the required language.
- 3. Confirm by clicking of the close box.
- ➔ The required language will be set.

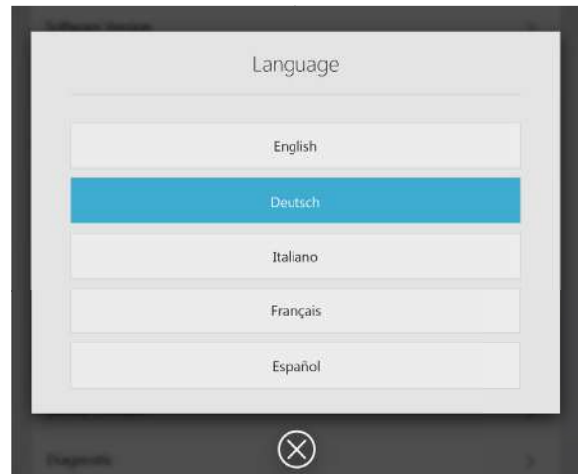

### 7.2.3 Setting touch screen brightness

To adjust the brightness of the touch screen and the operating panel, proceed as follows:

- ☑ You are in the main menu [Settings].
- 1. Select [Display brightness] in the menu.  
The possible levels of brightness are displayed.
- 2. Tap on the desired option.
- 3. Confirm by clicking of the close box.
- ➔ The new brightness level will be set.

## Making General Setting Changes in the Operating Panel

### 7.2.4 Setting the time zone and date format

To set the time zone and date format, proceed as follows:

- ☑ You are in the main menu [Settings].
- 1. Select [Time and date format] in the menu.  
The possible options are shown.
- 2. Select the desired date format in the upper section.
- 3. Select the time zone in which the machine is located under [Time zone].
- 4. Confirm by clicking of the close box.
- ➔ Time zone and date format are set.

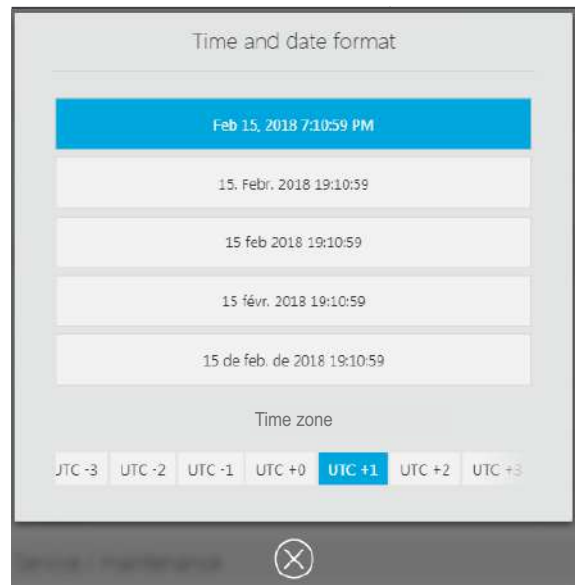

### 7.2.5 Activating / deactivating the communication function

To create logs and diagnostic data for service or in the event of failure or to be informed about software updates, proceed as follows:

- ☑ You are in the main menu [Settings].
- 1. Select [Communication] in the menu.  
The possible options are displayed.
- 2. Activate or deactivate the desired option with the slide switch.
- 3. Confirm by clicking of the close box.
- ➔ The communication function is activated / deactivated.



### 7.2.6 Activate / deactivate the active suction

To activate / deactivate the connected suction, proceed as follows:

- ☑ You are in the main menu [Settings].
- 1. Select [Adjust active suction] in the menu.
- 2. Activate or deactivate the suction using the slide switch.
- 3. Confirm by clicking of the close box.
- ➔ The suction is activated or deactivated.

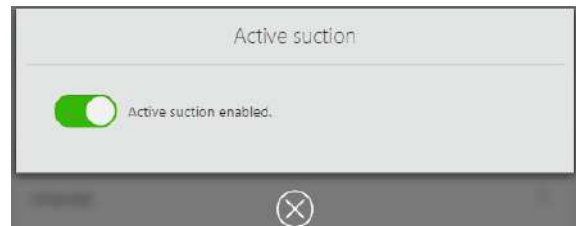

### 7.2.7 Unlocking the front flap

To unlock the front flap, proceed as follows:

- ☑ You are in the main menu [Settings].
- 1. Select [Unlock front flap] in the menu.
- 2. Follow the instructions in the operating panel.
- ➔ The front flap is unlocked.

## Making General Setting Changes in the Operating Panel

---

### 7.2.8 Restoring the coolant system

In order to restart the milling machine coolant system after the tank has been cleaned and the filter has been changed, proceed as follows:

---

#### **NOTICE! Residues in the coolant system.**

Damage to the filter.

Fast wear of the filter.

- ▶ Clean the milling chamber before restoring the coolant system.
- 

- ☑ Milling chamber has been cleaned ("Cleaning the milling chamber and the seal of the front flap", page 157).
- ☑ Tank and filter have been cleaned ("Changing the coolant fluid in the PrograMill Tank", page 170).
- ☑ You are in the main menu [Settings].

1. Select [Restore coolant system] in the menu.
2. Confirm that the milling chamber has already been cleaned by pressing [Start].

- ➔ The coolant system is restored.

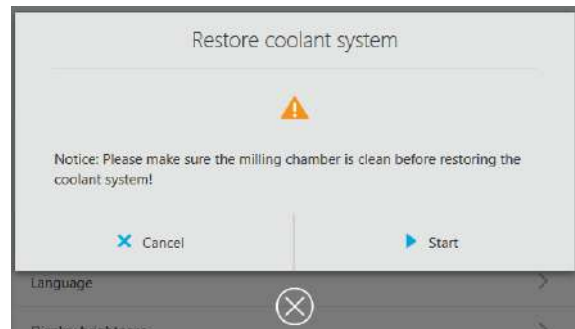

### 7.2.9 Managing cleaning notifications

To activate /deactivate the cleaning messages display in the operating panel, proceed as follows:

- ☑ You are in the main menu [Settings].
1. Select [Manage cleaning notifications] in the menu.
  2. Activate or deactivate the messages using the slide switch.
  3. Confirm by clicking of the close box.

- ➔ The cleaning messages display is activated or deactivated.

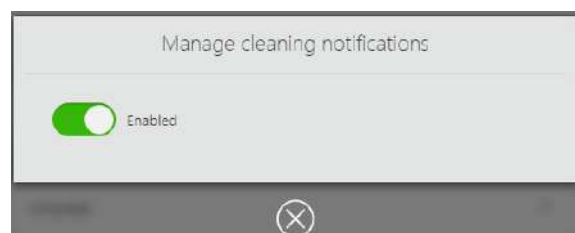

## 8 Editing Milling Jobs



The device receives the defined milling jobs from the CAM software "PrograMill CAM".

For information on how to prepare restorations with the CAM software "PrograMill CAM", calculate milling paths and transfer the milling jobs to the device, please refer to the "PrograMill CAM" User Manual ("Supporting documents", page 9).

The following describes how to prepare the milling jobs in the operating panel for processing on the device.

---

### 8.1 Switching the machine on



Each time the machine is switched on the same process is performed as in the initial start-up ("Switching the device on for the first time", page 55).

The only difference is that in the main menu [Overview], the disc or block holders already inserted in the device are displayed, and in the [Tools] menu, the loaded tool magazines are displayed.

---

### 8.2 Configuring and managing tool magazines and tools

The tools are inserted into the device by means of a tool magazine. In the operating panel you can manage 4 tool magazines each with 13 slots for tools.



Insert or replace the tool magazine or tools as described in the following sections:

- "Using new tools and configuring a tool magazine", page 98
- "Removing unnecessary, worn or defective tools", page 104



In each tool magazine slot M is assigned with a dummy tool (shaft and ring) and cannot be changed or re-assigned.

---



We recommend that you enter used tools which are currently not in use in the operating panel in the sub-menu "Used Tool Library" and store the actual tools in the "Used Tool Library for PM3/5/7" container which is included in the PrograMill delivery form ("Sub-menu [Used Tool Library]", page 6):

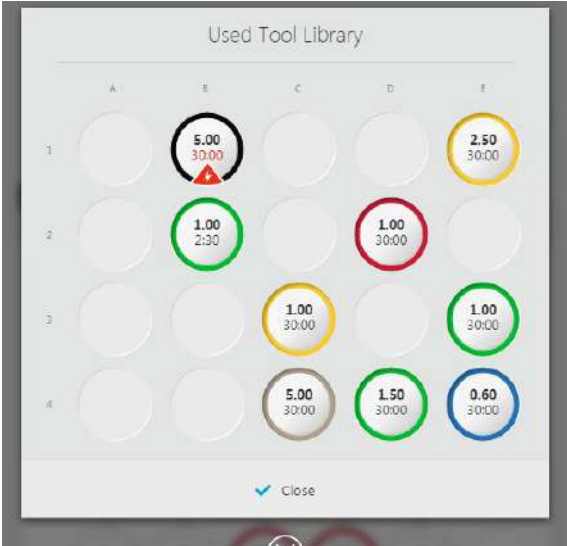

Unused tool magazines can also be stored in the PrograMill Base cabinet.



### 8.2.1 Using new tools and configuring a tool magazine

To place tools into a new magazine, proceed as described in the following sections.



When the device is delivered, an empty tool magazine is installed in the device.

If you already had tools in use and stored them in the Used Tool Library (“Working with the Used Tool Library”, page 110), it is possible to use these instead of placing a new tool into the tool magazine slot.

In each tool magazine slot M is assigned with a dummy tool (shaft and ring) and cannot be changed or re-assigned.

#### Selecting the tool magazine in the operating panel

- You are in the main menu [Tools].
- There are no milling jobs being worked on at the moment.

1. To select the tool magazine to be configured, tap the tab of the desired tool magazine (magazine 1-4).
2. If the tool magazine is already installed in the machine:
  - a. Tap on the key [Unload tool magazine].

The tool changer is driven into position in the milling chamber.
  - b. Follow the instructions in the operating panel.
  - c. Open milling chamber (“Opening the milling chamber”, page 99).
  - d. Remove the tool magazine (“Removing the tool magazine”, page 99).

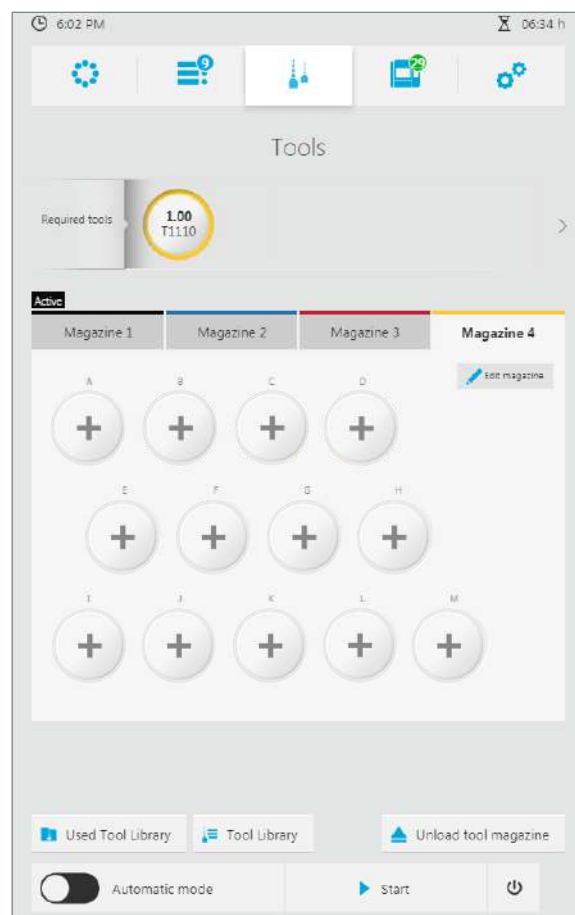

### Opening the milling chamber

**⚠ CAUTION!** The PrograMill Base (or comparable cabinet) drawer is open when opening the milling chamber.

Risk of crushing.

- ▶ Before opening the milling chamber, close the drawer of the PrograMill Base (or other cabinet).
- ▶ Close the drawer after all tasks / after every use.

1. If the tool changer is not yet in position: Tap the [Unload tool magazine] key in the operating panel and follow the instructions displayed there.
2. Open the milling chamber



### Removing the tool magazine

- ▶ Withdraw the tool magazine from the tool changer and remove it from the milling chamber.

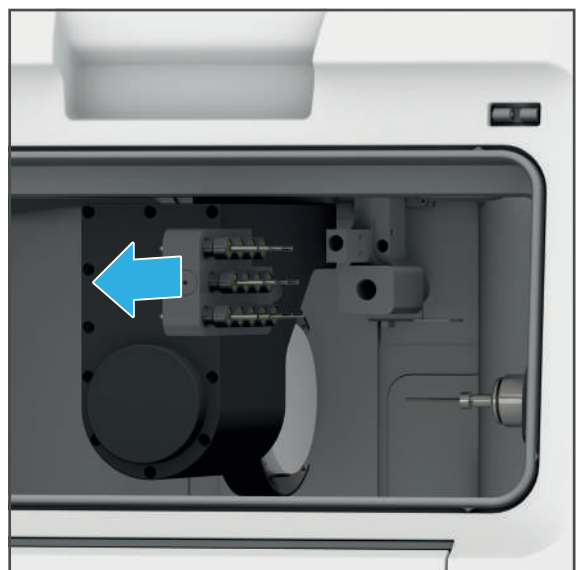

### Inserting a new tool

---

**NOTICE! Incorrect or incorrectly installed / configured inserted tool.**

Collision, tool breakage.

Damage to the device.

- ▶ Only insert and use approved tools.
  - ▶ Insert the tool into the slot with the cutting edge facing downwards, as shown below.
  - ▶ Only select approved tools in the operating panel.
  - ▶ Observe the correct sequence in the operating panel.
  - ▶ Ensure that the tool is inserted into the correct slot in the tool magazine.
  - ▶ Ensure that all screws are secure.
  - ▶ Do not insert with force.
- 



**CAUTION! Sharp tools.**

Cutting injuries.

- ▶ Only grasp the milling tools on the shaft, not on the cutting edge.
  - ▶ Do not hold the tool magazine freely in your hand during tool exchange; instead, place it on the PrograMill Base cabinet or on another suitable working surface and assemble there.
  - ▶ When handling the tools, be careful not to injure yourself or others.
- 

**NOTICE! Sharp tools.**

Damage to the work surface (table top or other area of placement).

- ▶ To assemble the tool magazine, place it onto the PrograMill Base cabinet or onto another hard-wearing working surface with a suitable protective cover.
-

1. **When using the PrograMill Base cabinet:** Place the tool magazine into the appropriate foam insert in the cabinet.  
– or –  
**Without the PrograMill Base:** Place the tool magazine on a hard-wearing working surface or one that has a suitable protective cover.
2. Insert the tool (1) into the slot (2) with the cutting edge facing downwards.

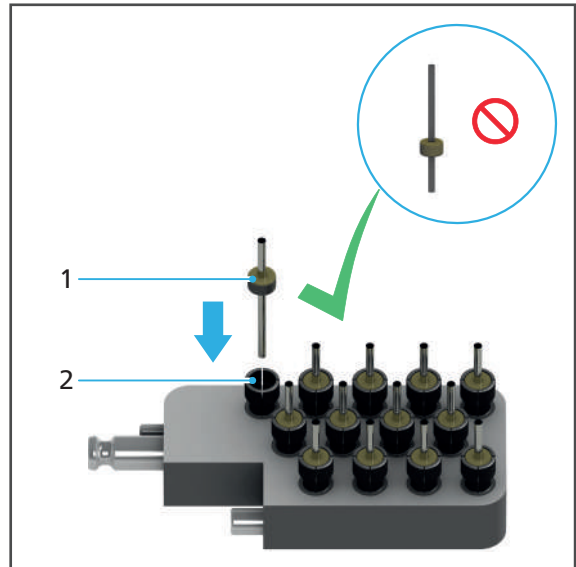

3. Tap on the operating panel on an unoccupied slot:

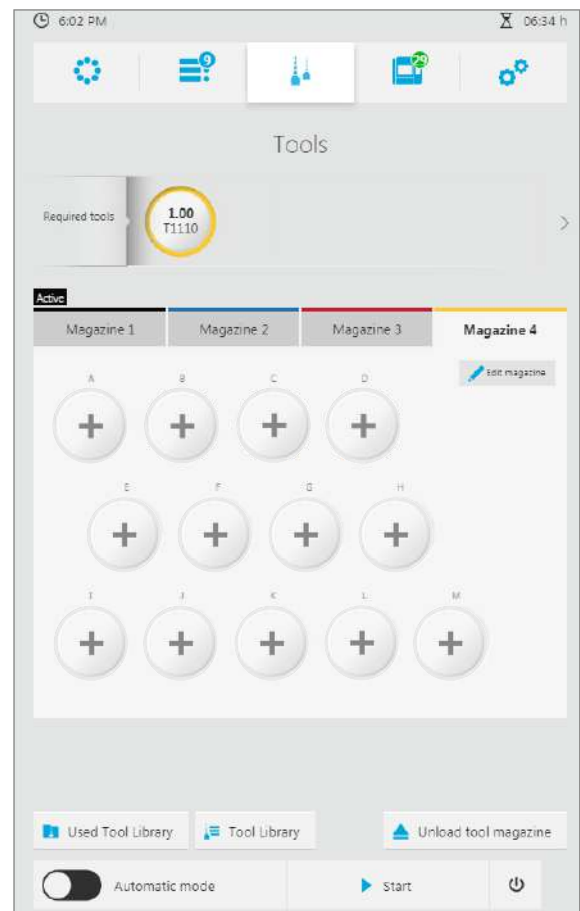

The Tool Library is displayed.

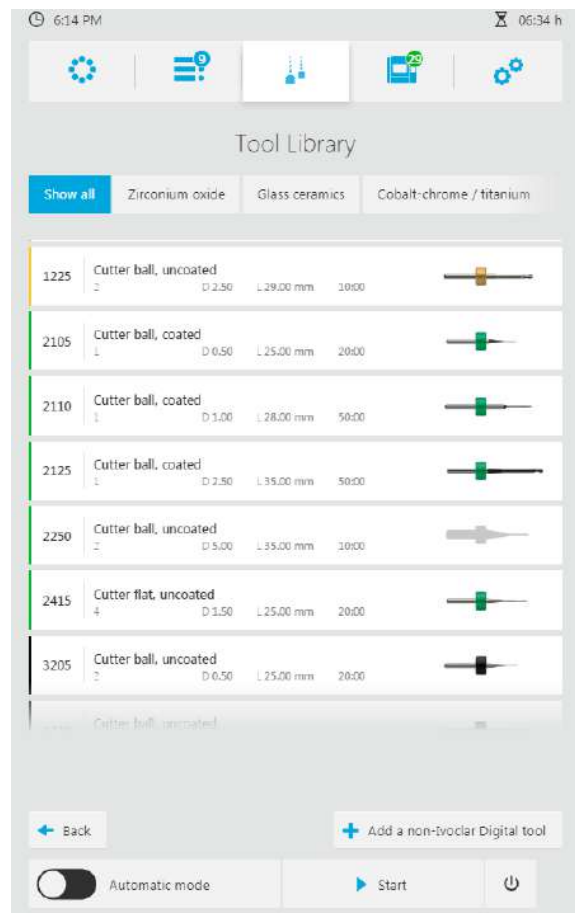

4. Tap on the required material type in the Tool Library on the operating panel.



All settings have already been made for Ivoclar Digital tools.

---

5. Tap on the desired tool in the list of Ivoclar Digital tools.  
– or –  
Determine a new non-Ivoclar Digital tool ("Defining non-Ivoclar Digital tools", page 108).
  6. Tap on [Back].  
The new tool is displayed in the tool magazine.
  7. Repeat the above steps for all necessary tools.
- ➔ The tool magazine is configured.
  - ➔ You can insert the tool magazine as described in the following sections.

### Inserting the tool magazine

1. If the tool changer is not yet in position: Tap the [Unload tool magazine] key in the operating panel and follow the instructions displayed there.
2. Insert the tool magazine into the tool changer.

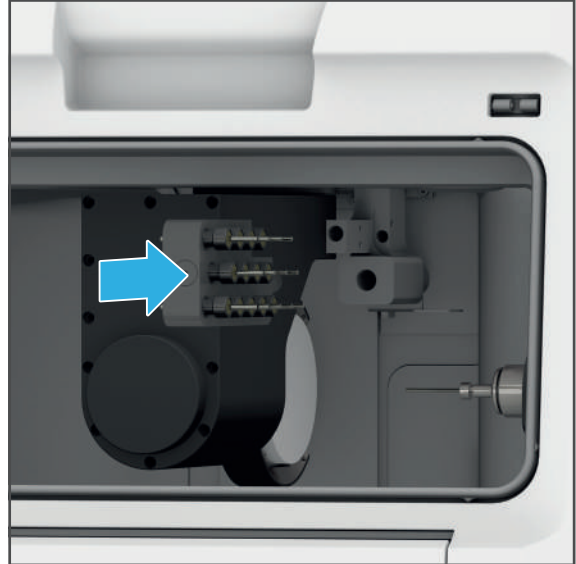

### Closing the milling chamber

**⚠ CAUTION!** When closing the front flap, caution with fingers between the front flap and the device.

Risk of crushing.

- ▶ Close the milling chamber carefully.

- ▶ Close milling chamber

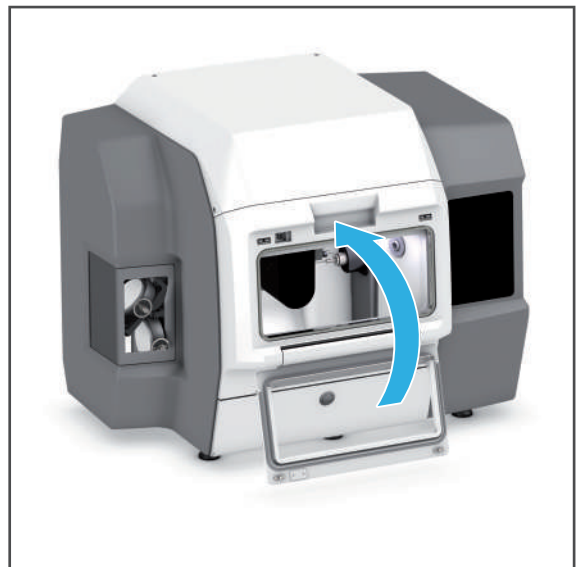

### 8.2.2 Removing unnecessary, worn or defective tools

**NOTICE! Tool life not observed / significantly exceeded.**

Broken cutter. Damage to the device

- ▶ Remove the tool at the end of its service life and replace it with a new tool.

To remove tools from a magazine, proceed as described in the following sections.

There are two options possible for removal:

- Remove worn, defective tools from the system.
- Place tools which are not required but still intact into the Used Tool Library for later use.

#### Selecting the tool magazine in the operating panel

- You are in the main menu [Tools].
- There are no milling jobs being worked on at the moment.

1. To select the tool magazine to be configured, tap the tab of the desired tool magazine (magazine 1–4).
2. If the tool magazine is already installed in the machine:
  - a. Tap on the key [Unload tool magazine].

The tool changer is driven into position in the milling chamber .
  - b. Follow the instructions in the operating panel.
  - c. Open milling chamber (“Opening the milling chamber”, page 99).
  - d. Remove the tool magazine (“Removing the tool magazine”, page 99).





### Removing tools



#### CAUTION! Sharp tools.

Cutting injuries.

- ▶ Only grasp the milling tools on the shaft, not on the cutting edge.
- ▶ Do not hold the tool magazine freely in your hand during tool exchange, instead, place it in the PrograMill Base cabinet or on another suitable working surface and configure there.
- ▶ When handling the tools, be careful not to injure yourself or others.

#### NOTICE! Sharp tools.

Damage to the work surface (table top or other area of placement).

- ▶ To configure the tool magazine, place it in the PrograMill Base cabinet or onto another hard-wearing working surface with a suitable protective cover.



Pliers are included in delivery form for easier removal of tools from the tool magazine (PrograMill Tool Plier).

1. **When using the PrograMill Base cabinet:** Place the tool magazine into the appropriate foam insert in the cabinet.  
– or –  
**Without the PrograMill Base:** Place the tool magazine on a hard-wearing working surface or one that has a suitable protective cover.
2. Remove specific tool (1) from the slot (2).

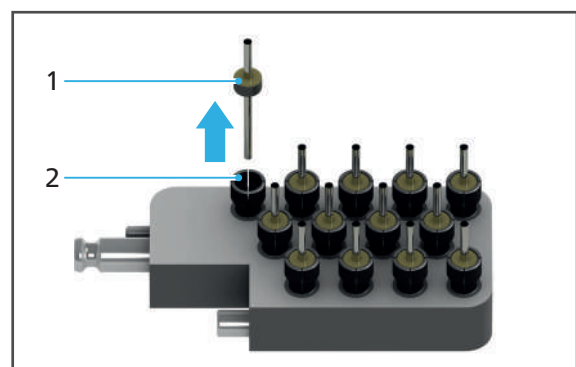

## Editing Milling Jobs

3. In the operating panel, tap the slot containing the appropriate tool.  
Example:



A detailed view of the tool is displayed.

4. To delete the tool: Select [Delete tool].  
– or –

To place the tool in the “Used Tool Library”: Select [Save in Used Tool Library].

The tool is removed and deleted from the slot or placed into the “Used Tool Library”.

5. Repeat the above steps for all necessary tools.

- ➔ You can either insert spare tools (“Inserting a new tool”, page 100) or place the magazine back into the machine (“Inserting the tool magazine”, page 103 and “Closing the milling chamber”, page 103).

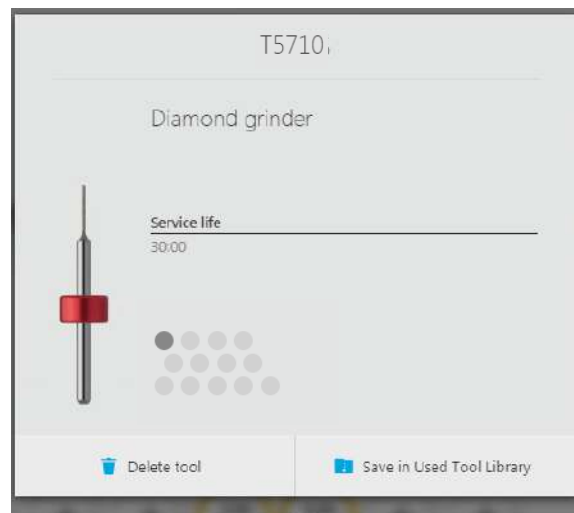

## 8.2.3 Working with the Tool Library

In the Tool Library you can view detailed information about all Ivoclar Digital tools and define non-Ivoclar Digital tools for later use. You can also access the Tool Library via several dialogues for inserting tools, and directly select the tools that are to be inserted into the slot of a particular tool magazine ("Using new tools and configuring a tool magazine", page 98).

The following describes how to view the Tool Library without using the insertion process.

### Showing Ivoclar Digital tools

- ☑ You are in the main menu [Tools].
- ▶ Tap on the key [Tool Library].
- ➡ The Tool Library is displayed.
- ➡ The approved Ivoclar Digital tools are shown under [Ivoclar Digital tools] (sorted according to material, "Sub-menu [Tool Library]", page 7).
- ➡ The manually configured non-Ivoclar Digital tools are shown under [Non-Ivoclar Digital tools] ("Defining non-Ivoclar Digital tools", page 108).

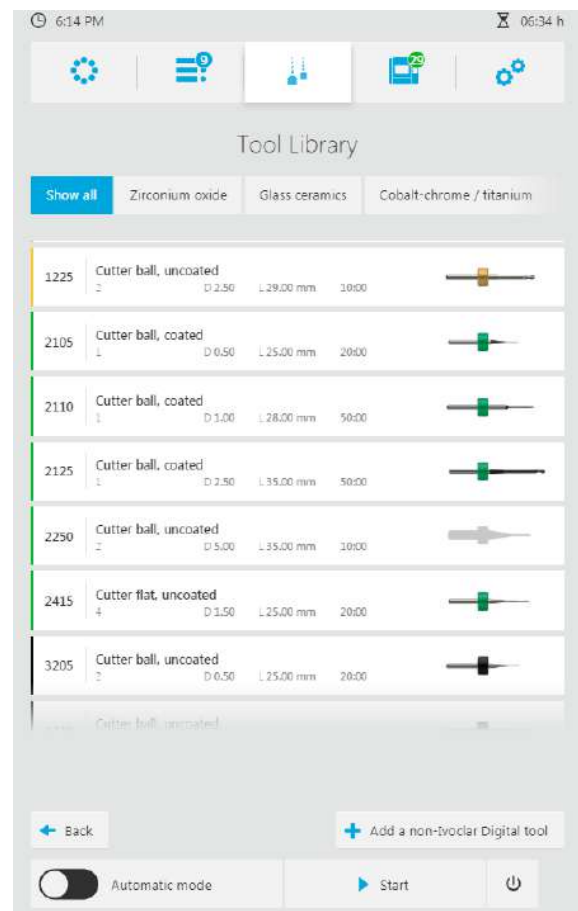

### Defining non-Ivoclar Digital tools



Ivoclar Vivadent assumes no liability for damage to the device or interference caused by incorrect configuration or the use of non-Ivoclar Digital tools!

You are in the main menu [Tools].

1. Tap on the key [Tool Library].

The Tool Library is displayed:

2. Tap the key [Add a non-Ivoclar Digital tool].

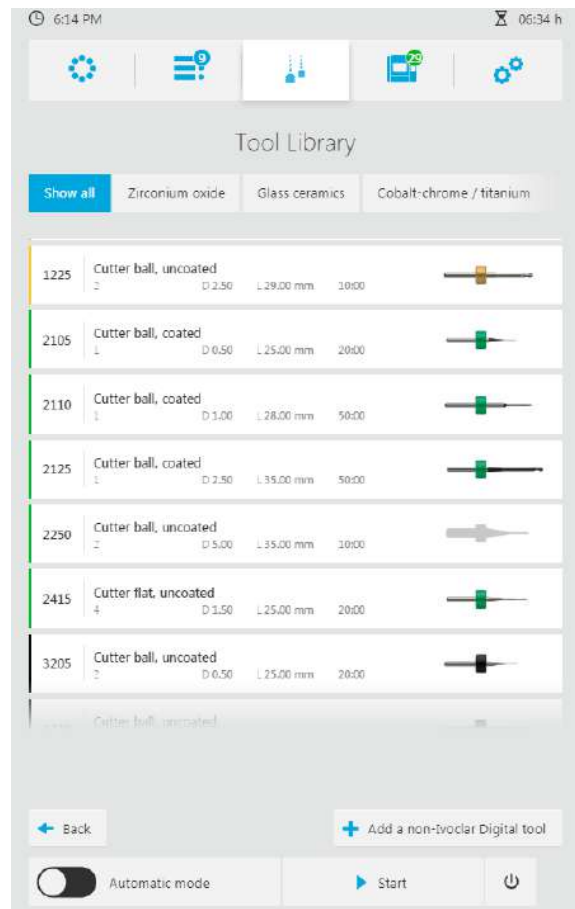

3. Fill in the displayed sections via the touch screen keyboard.

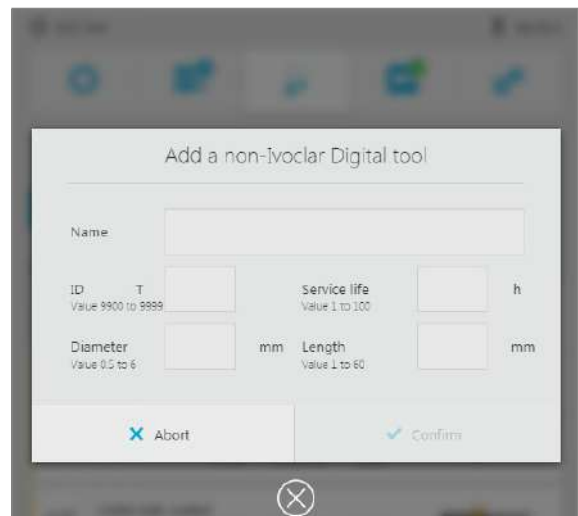

Incorrect entries are displayed in red as shown in the picture.

4. Correct the entries if necessary and confirm with [Confirm].

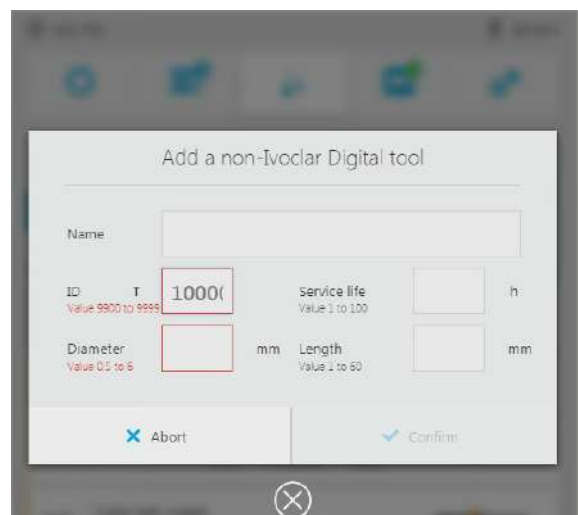

➔ The tool is defined.

### 8.2.4 Working with the Used Tool Library

The Used Tool Library allows you to manage used tools that are currently not being used after they have been removed from a tool magazine, and then store them until reuse at a later stage ("Removing unnecessary, worn or defective tools", page 104). A prerequisite for this is that the service life of the relevant tool has not yet been exceeded.

The allocation of spaces in the sub-menu "Used Tool Library" in the operating panel corresponds with the identification matrix of the container "Used Tool Library for PM3/5/7", which is included in the milling machine delivery form ("Delivery form", page 1).

When configuring tool magazines, you can access the tools stored in the Used Tool Library at a later stage ("Using new tools and configuring a tool magazine", page 98).

The following describes how to view the Used Tool Library without actually using the insertion process.

#### Displaying the Used Tool Library

- ☑ You are in the main menu [Tools].
- ▶ Tap on the key [Used Tool Library].
- ➔ The "Used Tool Library" is displayed.
- ➔ The tools stored in the "Used Tool Library" are displayed.



### 8.3 Managing discs and blocks

Depending on the material used, disc holders with different rings as well as a block holder (IPS e.matrix® for PM3, PM5, PM7) are available.

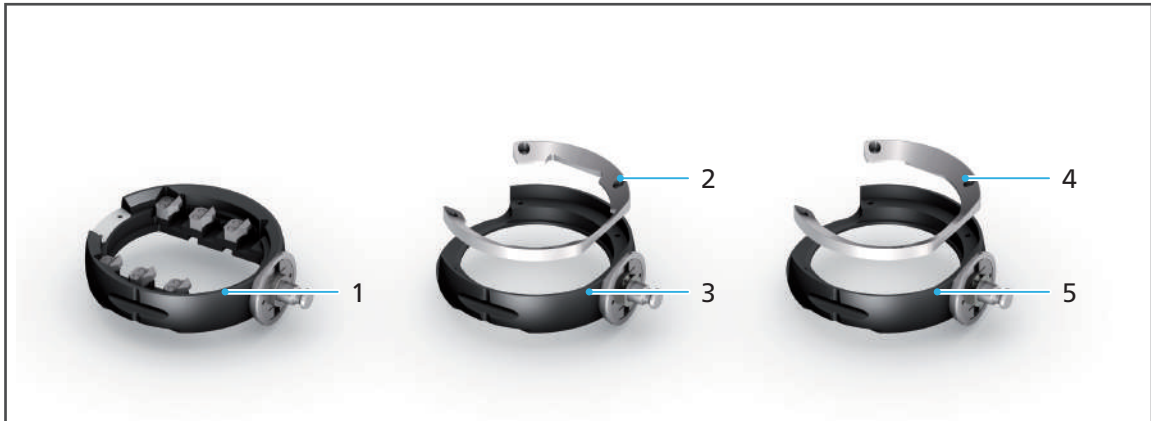

No.	Element	Description	Reference	
1	Multi block holder IPS e.matrix® for PM3, PM5, PM7	Takes up to 6 blocks of the IPS e.max®, IPS Empress® CAD or Telio® CAD etc. range ("Intended use", page 1). The blocks are screwed into individual holders.	"IPS e.matrix: Preparing the block holder", page 120	
2-3	Disc holder with standard ring	Takes all types of discs	<ul style="list-style-type: none"> <li>• "Standard disc holder: Preparing the disc holder (zirconium oxide, PMMA /DCL, wax)", page 113</li> <li>• "Standard disc holder: Preparing the disc holder (cobalt chrome, titanium)", page 116</li> </ul>	
		2		Standard ring with 4 screws
		3		Disc holder

## Editing Milling Jobs

---

No.	Element	Description	Reference	
4-5	Disc holder for the Digital Denture process	For the production of dentures in two processing steps. With the possibility to re-fix a disc for further processing which has already been milled from the top. <ul style="list-style-type: none"> <li>• Step 1: Milling with the standard ring (pos. 2): The milling machine mills a groove into the disc so that it can be repositioned correctly.</li> <li>• Step 2: Milling with the ring (pos. 4): For the second processing step, for repositioning the machined disc for further milling steps</li> </ul>	"Digital Denture: Preparing the disc holder (zirconium oxide, PMMA /DCL, wax)", page 117	
		4		Ring 2 with 4 screws
		5		Disc holder

Insert or replace them as described in the following sections:

- "Inserting the required discs and blocks", page 113
- "Removing no longer required or defective discs and blocks", page 125



### 8.3.1 Inserting the required discs and blocks

To insert discs and blocks into the device, proceed as described in the following sections.



Discs and blocks can be loaded from the main menu [Overview] or from the main menu [Job list] via the detailed view of the disc / block holder ("Detailed view of the disc or block holder and the milling jobs assigned to it", page 65).

The procedure is described in the main menu [Overview].

---

**NOTICE! Incorrect or incorrectly fixed blocks. Incorrect ring used for the disc.**

Block / disc is falling out of holder. Broken cutter.

Damage to the device.

- ▶ Only insert and use approved discs / blocks.
  - ▶ Ensure that all screws are secure.
- 

**Standard disc holder: Preparing the disc holder (zirconium oxide, PMMA /DCL, wax)**

---

**NOTICE! The screws are not fixed securely in the disc holder.**

Disc is falling out of disc holder. Broken cutter.

Damage to the device.

- ▶ Ensure that all screws are secure.
-

**NOTICE! Too high torque.**

Damage to the clamping surface when inserting and removing the disc several times.

Damage to the device.

- ▶ Do not tighten the screws completely to the specified torque level.
- 

1. If the disc holder or a different holder is still in the machine: Remove disc holder ("Opening the material changer", page 122 and "Removing disc or block holders from the material changer", page 138).

2. Insert the disc (2) into the disc holder (3).

3. Insert the outer ring / standard ring (1).

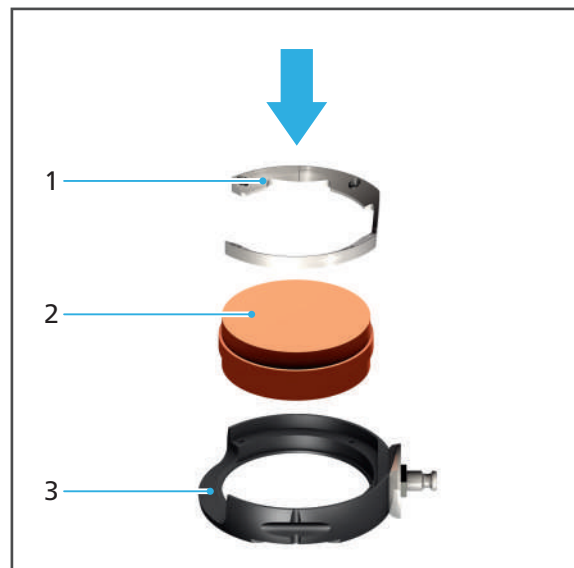

4. Align the RFID label (4) of the disc so that it is positioned centrally in the recess on the disc holder.

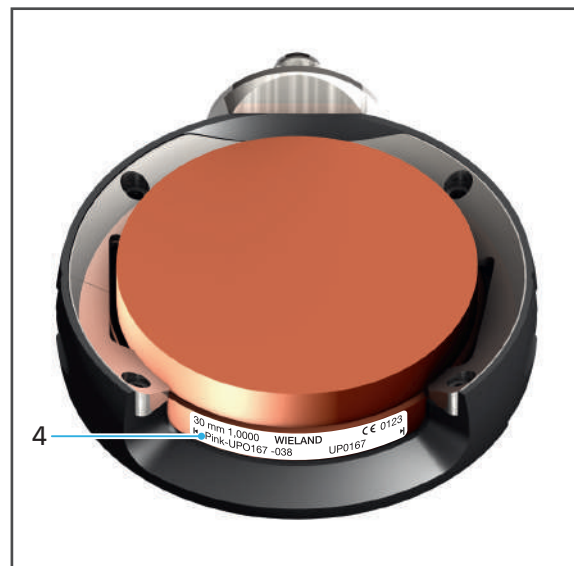

**NOTICE! The screws are screwed in too far.**

Damaged disc.

- ▶ Tighten the screws cross-wise.
  - ▶ Do not over-screw the screws.
- 

**NOTICE! Too high torque.**

Damage to the clamping surface when inserting and removing the disc several times.

Damage to the device.

- ▶ Do not tighten the screws completely to the specified torque level.
- 

5. Tighten the screws (5) cross-wise using a torque wrench (zirconium oxide and wax: 0.45 Nm, PMMA: 2.8 Nm).

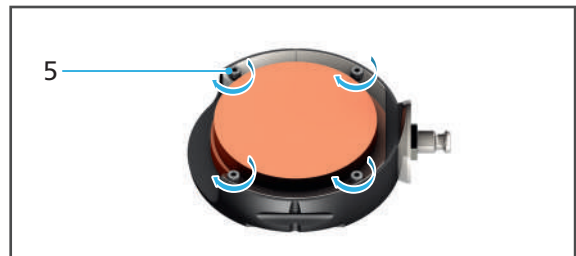

### Standard disc holder: Preparing the disc holder (cobalt chrome, titanium)

---



Due to the fact that the RFID reader in the device cannot read the RFID label on cobalt chrome and titanium, the label needs to be read from the disc packaging via the CAM software "PrograMill CAM". The RFID container included in the delivery form needs to be encoded (see the User Manual for the "PrograMill CAM", "Supporting documents", page 9).

---

#### **NOTICE! The screws are not fixed securely in the disc holder.**

Disc is falling out of disc holder. Broken cutter.

Damage to the device.

- ▶ Ensure that all screws are secure.
- 

1. If the disc holder or a different holder is still in the machine: Remove disc holder ("Opening the material changer", page 122, and "Removing disc or block holders from the material changer", page 138).
2. Position the RFID container (3) in the disc holder (4).
3. Insert the disc (2) into the disc holder (4).
4. Insert the outer ring (1).

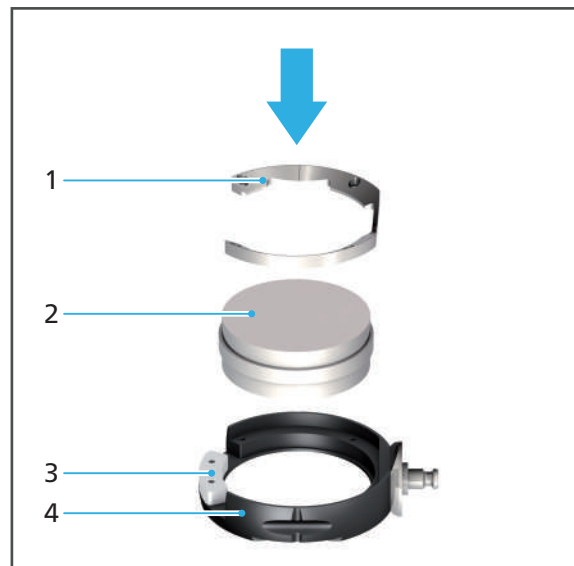

#### **NOTICE! The screws are screwed in too far.**

Damaged disc.

- ▶ Tighten the screws cross-wise.
  - ▶ Do not over-screw the screws.
- 

5. Tighten the screws (5) cross-wise using a torque wrench (2.8 Nm).

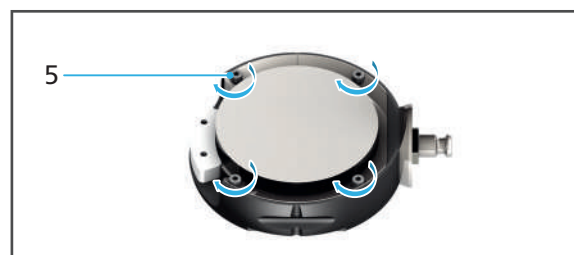

### Digital Denture: Preparing the disc holder (zirconium oxide, PMMA /DCL, wax)

- ☑ In the CAM software "PrograMill CAM", there are milling jobs with suitable milling strategies (see User Manual for the "PrograMill CAM", "Supporting documents", page 9).

---

#### NOTICE! The screws are not fixed securely in the disc holder.

Disc is falling out of disc holder. Broken cutter.

Damage to the device.

- ▶ Ensure that all screws are secure.

---

#### NOTICE! Too high torque.

Damage to the clamping surface when inserting and removing the disc several times.

Damage to the device.

- ▶ Do not tighten the screws completely to the specified torque level.

- 
1. If the disc holder or a different holder is still in the machine: Remove disc holder ("Opening the material changer", page 122, and "Removing disc or block holders from the material changer", page 138).
  2. Insert the disc (2) into the disc holder (3).
  3. Insert outer ring / standard ring (1).

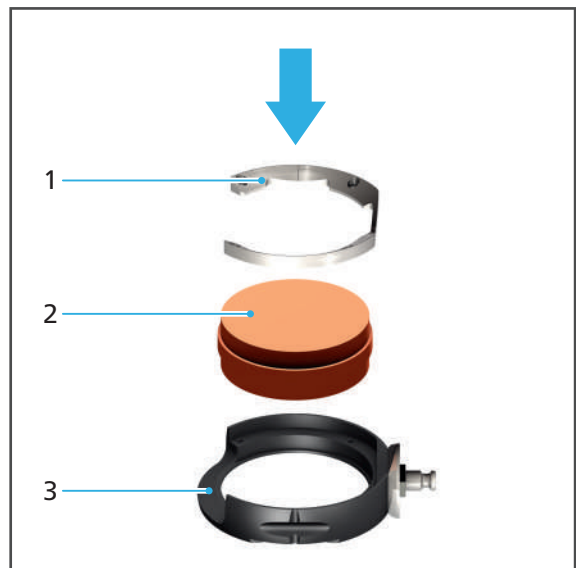

## Editing Milling Jobs

---

4. Align the RFID label (4) of the disc so that it is positioned centrally in the recess on the disc holder.

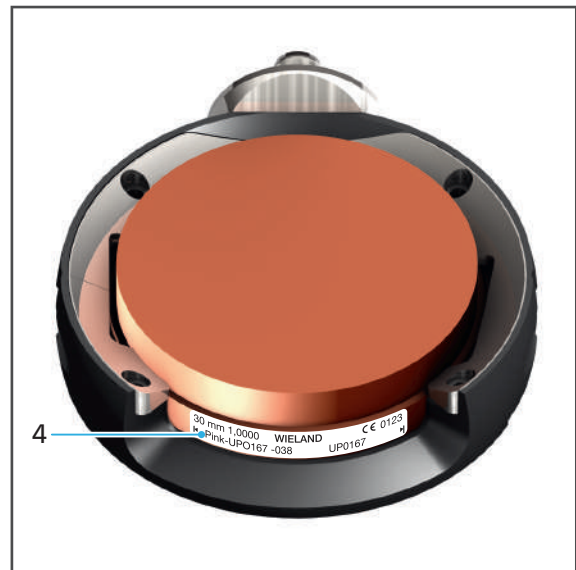

---

**NOTICE! The screws are screwed in too far.**

Damaged disc.

- ▶ Tighten the screws cross-wise.
- ▶ Do not over-screw the screws.

---

**NOTICE! Too high torque.**

Damage to the clamping surface when inserting and removing the disc several times.

Damage to the device.

- ▶ Do not tighten the screws completely to the specified torque level.

- 
5. Tighten the screws (5) cross-wise using a torque wrench (zirconium oxide and wax: 0.45 Nm, PMMA: 2.8 Nm).

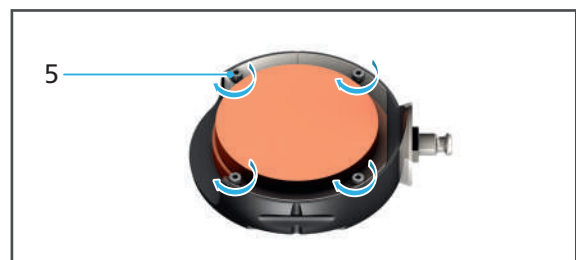

6. Mill the first step of processing and then remove (first milling job).

7. Insert the disc (7) into the disc holder (8).
8. Insert outer ring / ring 2 (6).

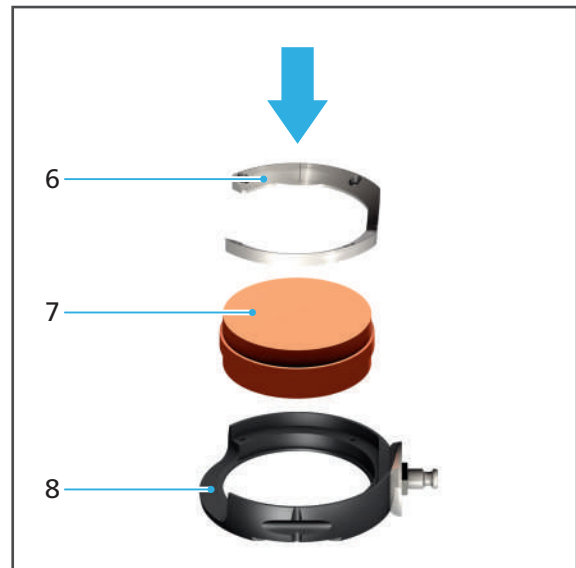

**NOTICE! The screws are screwed in too far.**

Damaged disc.

- ▶ Tighten the screws cross-wise.
- ▶ Do not over-screw the screws.

**NOTICE! Too high torque.**

Damage to the clamping surface when inserting and removing the disc several times.

Damage to the device.

- ▶ Do not tighten the screws completely to the specified torque level.

9. Tighten the screws (9) cross-wise using a torque wrench (zirconium oxide and wax: 0.45 Nm, PMMA: 2.8 Nm).

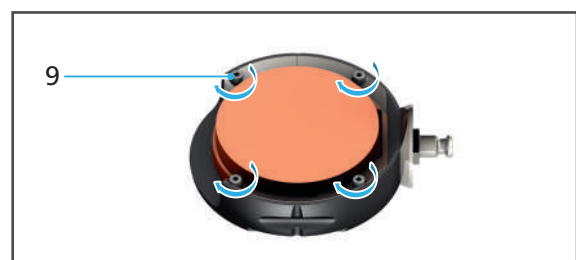

- ➔ Mill the second step of processing and then remove (second milling job).

### IPS e.matrix: Preparing the block holder

---



The RFID reader in the device cannot read the RFID labels when IPS e.matrix is used, because the individual blocks are not marked with an RFID label.

Therefore, the Data Matrix Codes need to be read from the packaging of the blocks to be used via the CAM software "PrograMill CAM".

Subsequently, the RFID container included in delivery form needs to be encoded (see User Manual for "PrograMill CAM", "Supporting documents", page 9).

---

**NOTICE! The wrong blocks have been inserted. The blocks have been mounted in the wrong place in the block holder. Screws have not been secured tightly enough.**

Damage to the device due to a broken cutter as a result of collision or a falling block.

- ▶ Ensure correct installation of correct blocks.
  - ▶ Ensure that all screws are secure.
- 

1. If the block holder or a different holder is still in the machine: Remove block holder ("Opening the material changer", page 122, and "Removing disc or block holders from the material changer", page 138).
- 

**NOTICE! The screws are screwed in too far.**

Damaged block.

- ▶ Do not over-screw the screws.
- 

2. Insert the blocks (1) into the brackets in the block holder.
3. Screw the screws tightly (2) at the relevant brackets with an Allen key (2.5 mm).
4. Repeat for other required blocks.

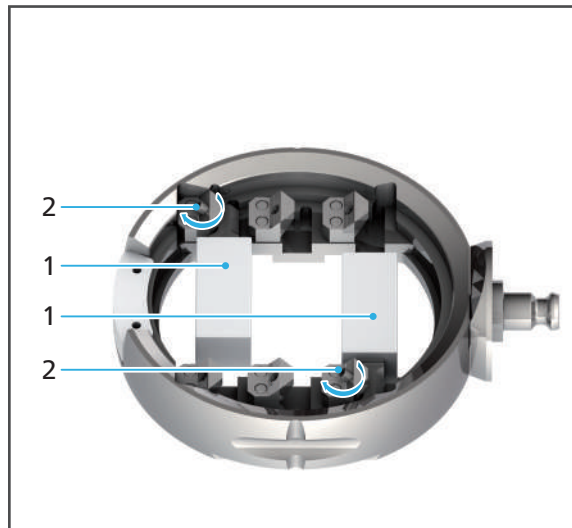



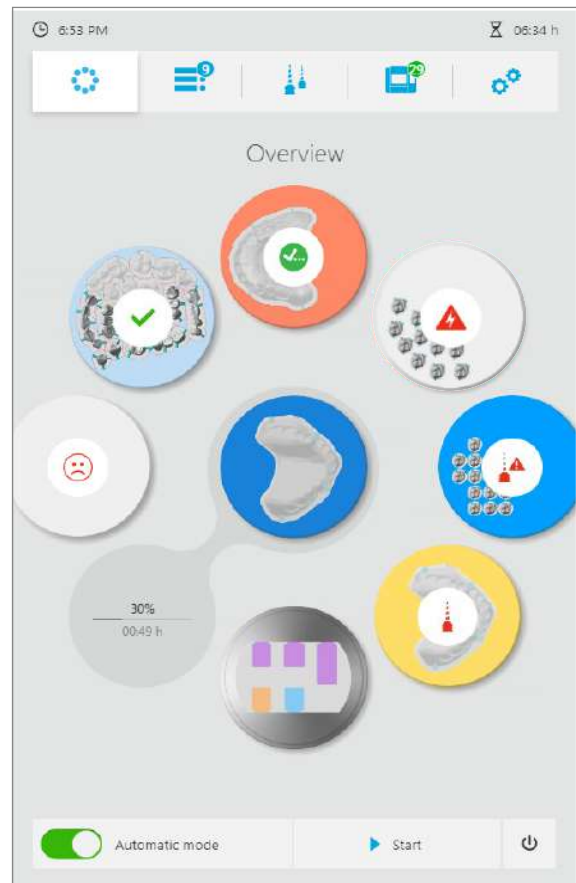

## Placing the material changer in the removal / insertion position

- ☑ You are in the main menu [Overview].
- 1. Tap the desired disc, a block holder or free space.

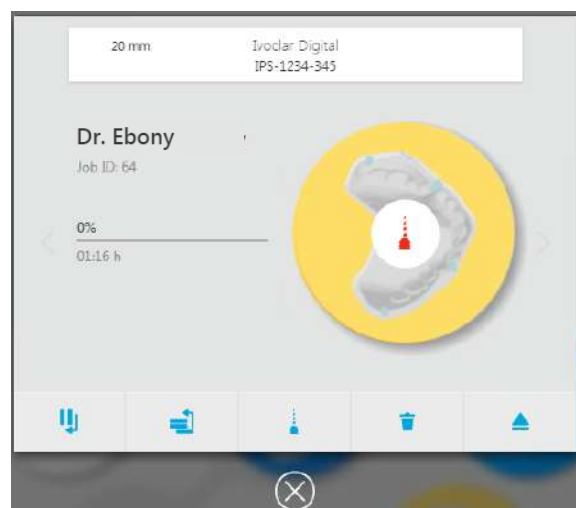

A detailed view of the disc or the block holder is displayed.



- 2. Tap on the symbol: 

- ➔ The empty space or corresponding disc of block holder is brought into the removal / insertion position in the material changer.

### Opening the material changer

---

! The illustrations in the following sections show the standard disc holder. The procedure is identical for standard disc holders, Digital Denture and IPS e.matrix.

---

- ▶ Open the material changer.

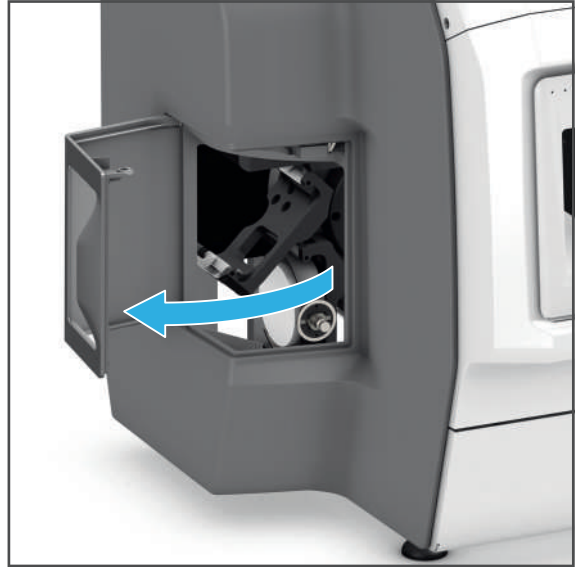

### Inserting the disc or block holder

**⚠ CAUTION!** Finger caught between the holder and place of insertion when placing the disc or block holder.

Risk of crushing.

- ▶ Close the milling chamber carefully.

**NOTICE!** Disc or block holder has been forcibly inserted into the material changer.

Damage to the RFID reader for the identification of the discs /blocks.

Damage to the device / material changer.

- ▶ Do not use force when inserting the disc or block holder into the material changer.

1. If there is already a disc or block holder in the place of insertion, remove the disc or block holder ("Opening the material changer", page 122, and "Removing disc or block holders from the material changer", page 138).
2. Insert the disc or block holder as illustrated in the guidance tracks (1 and 2).

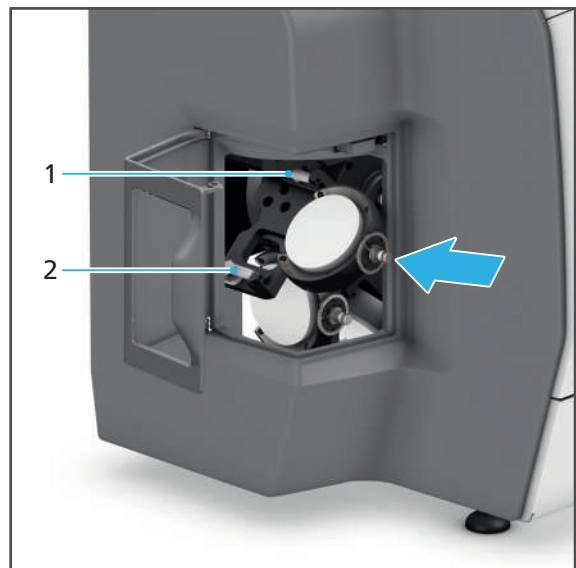

### Closing the material changer

---

**⚠ CAUTION!** Finger caught between material changer flap and machine when closing the material changer flap.

Risk of crushing.

▶ Close the material changer carefully.

---

▶ Close the material changer.



➔ The disc or the blocks located in the holder are read from the RFID reader into the system using the RFID label or the RFID container and displayed in the operating panel in the main menu [Overview].

### 8.3.2 Removing no longer required or defective discs and blocks

To remove no longer required or defective discs and blocks from the device, proceed as described in the following sections.



Discs and blocks can be removed from the main menu [Overview] or from the main menu [Job list] – via the detailed view of the disc / block holder (“Detailed view of the disc or block holder and the milling jobs assigned to it”, page 65).

The procedure is described in the main menu [Overview].

Information on the removal of successfully milled restorations can be found in the section “Finishing/ejecting a completed milling job”, page 136.

#### Placing the material changer in the removal / insertion position

- You are in the main menu [Overview].
- No milling jobs are processed which require the disc or block holder and the respective disc or blocks.

1. Tap on the desired disc or the block holder.

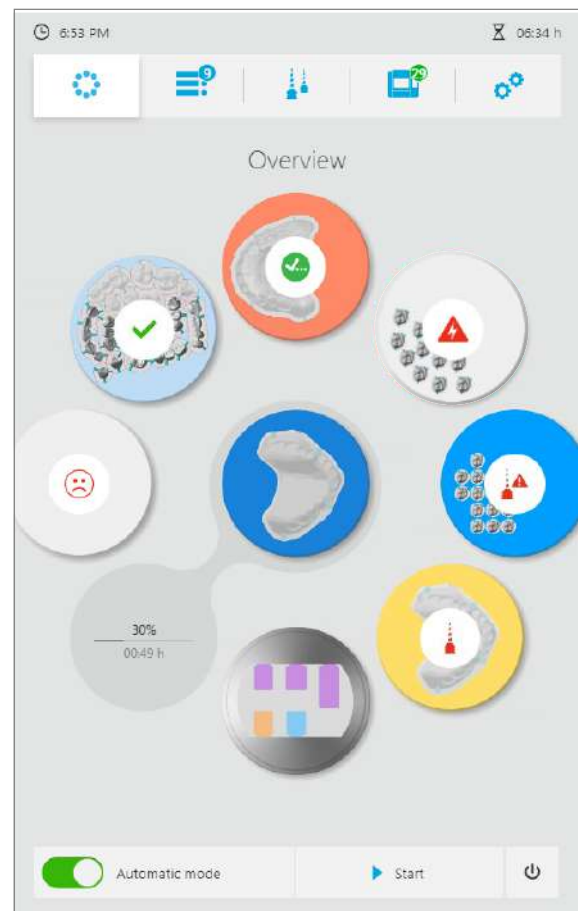

A detailed view of the disc or the block holder is displayed.

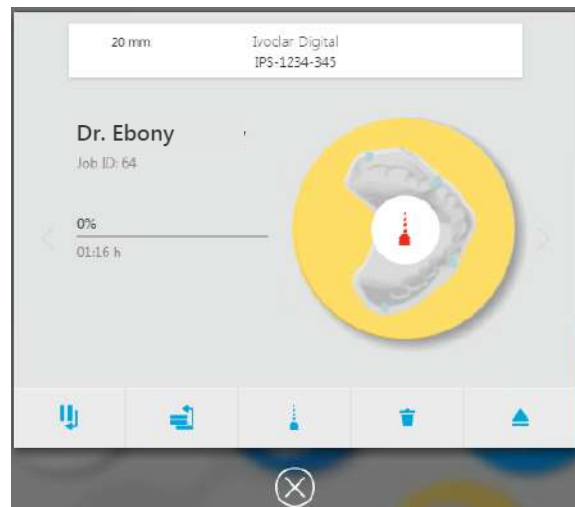

2. Tap on the symbol: 

➔ The empty space or corresponding disc or block holder is brought into the removal / insertion position in the material changer.

### Removing disc or block holders with discs / blocks

---



Removing the disc or block holder with a no longer required or defective disc or block is the same as the removal of a restoration described in the section "Completing the milling job and removing the finished restoration", page 136.

---

1. "Opening the material changer", page 122.
2. "Removing disc or block holders from the material changer", page 138.
3. "Standard disc holder / Digital Denture: Removing the disc from the disc holder (zirconium oxide, PMMA /DCL, wax)", page 139.  
– or –  
"Standard disc holder: Removing the disc from the disc holder (cobalt chrome, titanium)", page 140  
– or –  
"IPS e.matrix: Removing blocks from the block holder", page 140.
4. "Closing the material changer", page 141.

## 8.4 Preparing milling jobs

### 8.4.1 Showing milling jobs

- ▶ Select main menu [Job list]
- ➔ All running and pending milling jobs and all completed jobs that have not yet been ejected are displayed.

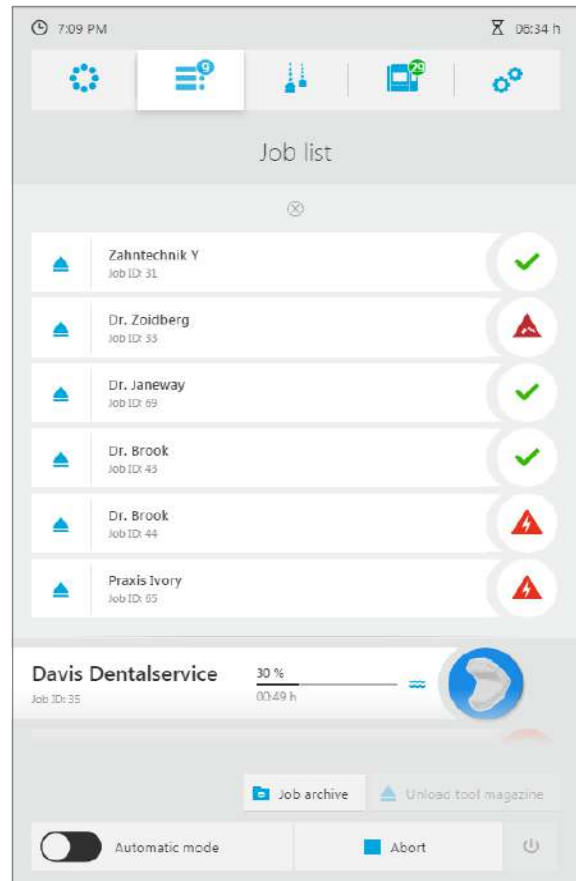

### 8.4.2 Showing milling job details

☑ Your are in the main menu [Job list].

1. Tap on the specific milling job.

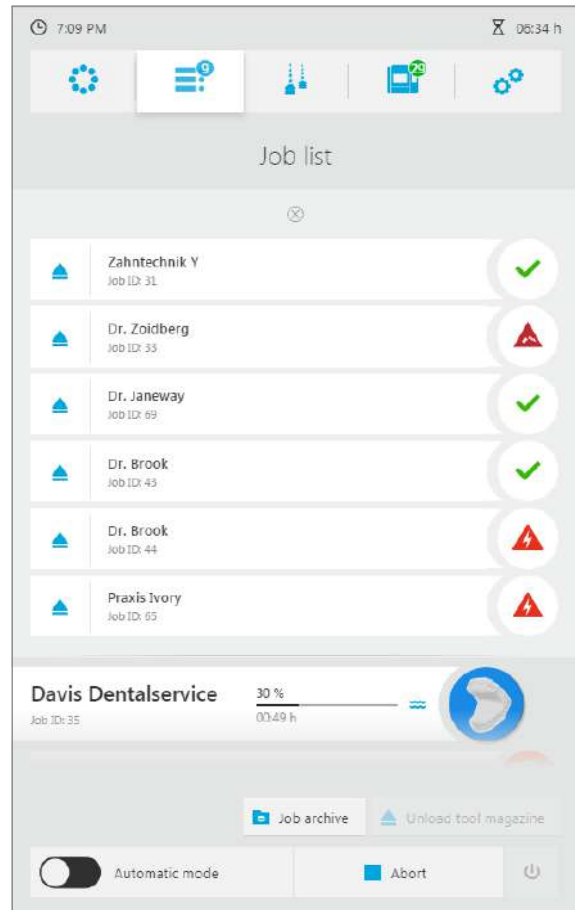

A detailed view of the milling job is displayed.

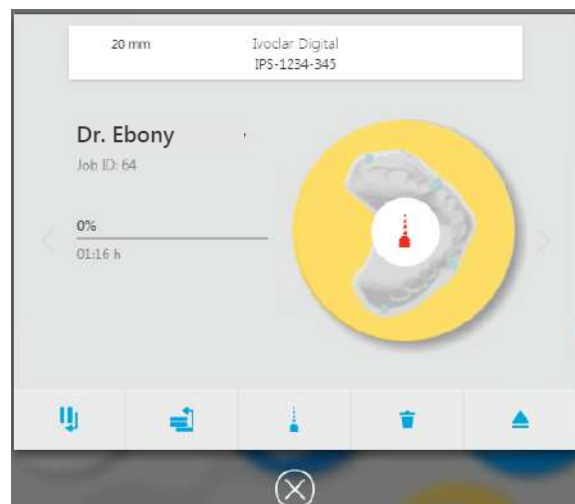

2. If necessary prepare discs / blocks (“Managing discs and blocks”, page 111).
3. If required, prepare the tool (“Configuring and managing tool magazines and tools”, page 1).



### 8.4.3 Setting the milling mode (switching automatic mode on and off)

In the milling mode, you can set whether all mill-ready milling jobs are to be processed at once or whether each milling job is to be started individually.

- Automatic mode is activated:  
As soon as the first milling job has been completed, the next milling job in the list is automatically started.
- Automatic mode is deactivated:  
Each milling job has to be started individually.

You can set the milling mode in the main menu.

1. Tap on [Automatic mode] in the quick start bar.  
The automatic mode is activated (ON).
2. Tap once again on [Automatic mode] in the quick start bar.  
The automatic mode is deactivated (OFF).

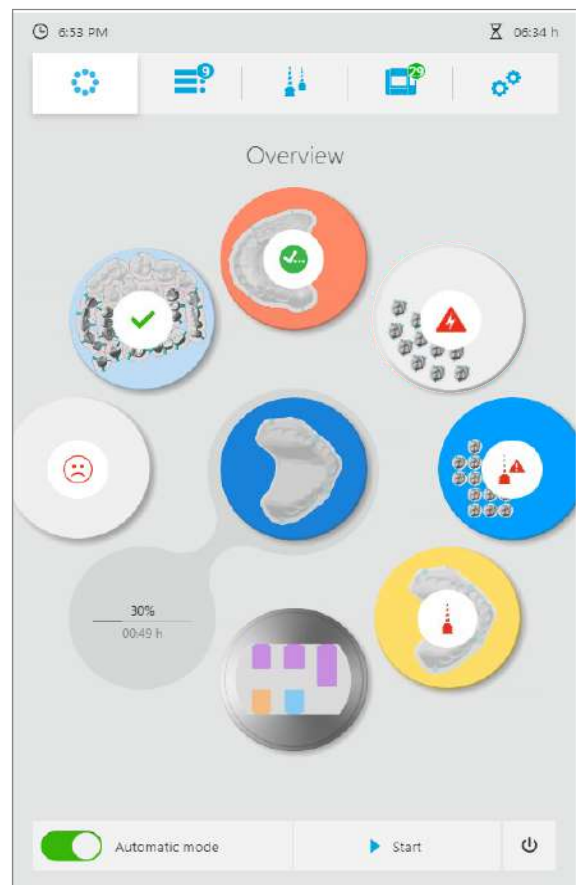

### 8.4.4 Deleting the milling job

The detailed view of a milling job offers the possibility to delete a milling job from the list of the upcoming jobs. Running jobs cannot be deleted.

! Milling jobs can be deleted from the main menu [Overview] or from the main menu [Job list] – via the detailed view of the disc / block holder (“Detailed view of the disc or block holder and the milling jobs assigned to it”, page 65).

The procedure in the main menu [Job list] is described below.

The milling job to be deleted is still pending.

1. Tap on the specific milling job.

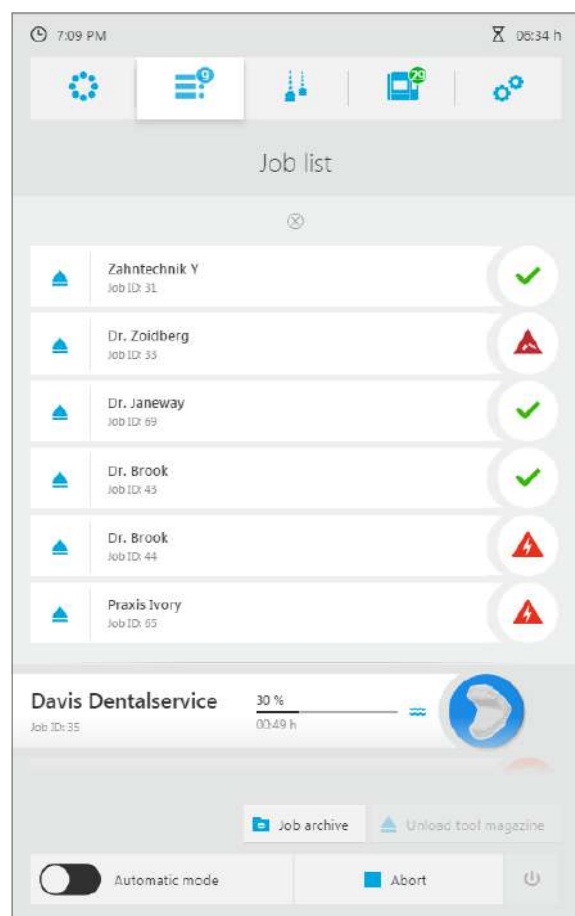

A detailed view of the milling job is displayed.

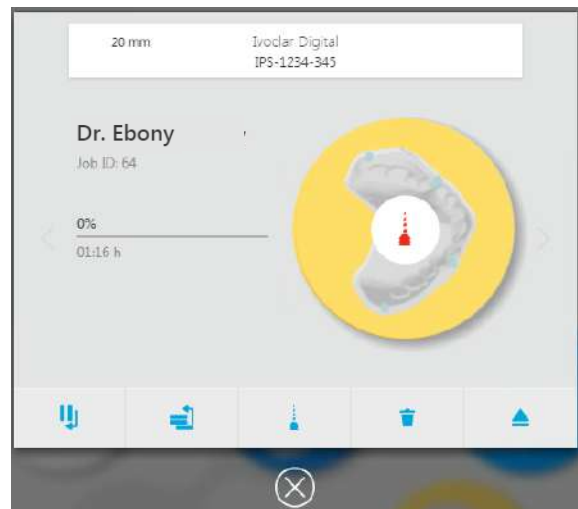

2. Tap on the symbol delete:



3. Confirm safety query.

➔ The milling job is removed from the list of upcoming jobs.

### 8.4.5 Specifying the sequence of milling jobs

In the main menu [Job list], all milling jobs transmitted by the CAD/CAM software to the milling machine which are waiting for processing are displayed.

You can transfer any number of milling jobs from the CAD/CAM software to the milling machine for later processing. The milling machine can process as many milling jobs in a milling sequence as there are corresponding discs / blocks and tools. By default, processing is performed chronologically, i.e. the milling jobs which were first transferred to the milling machine are processed first (first milling job at first position, second milling job at second position, etc.).

You can either leave the chronological sequence as it is, or set the milling job to the first position in the processing order as described below.

#### Setting the milling job to the first position in the processing order

A single milling job can be set to the first position of the processing order. If a job is currently being processed, the milling job is allocated after this job.

- You are in the main menu [Job list].
- At least two milling jobs are displayed.

## Editing Milling Jobs

1. Tap on the specific milling job.

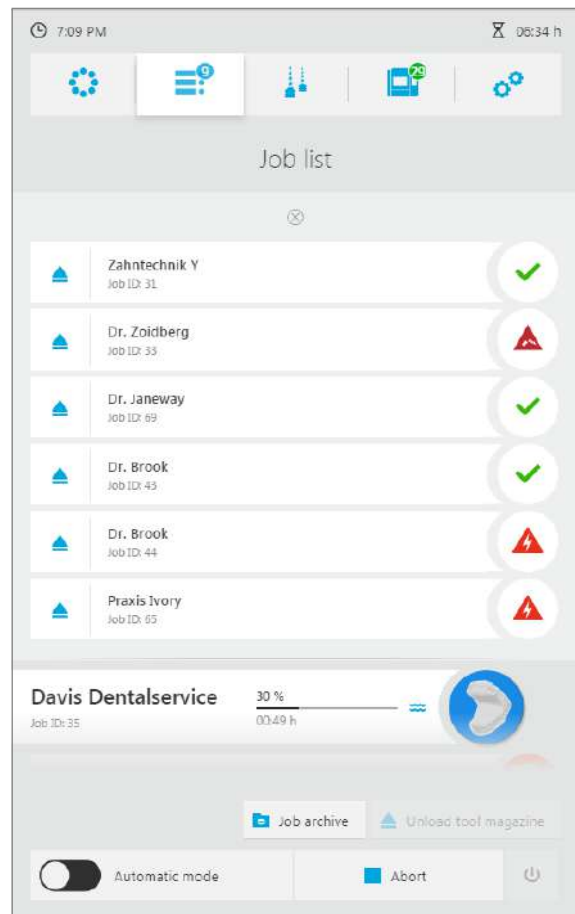

A detailed view of the milling job is displayed.

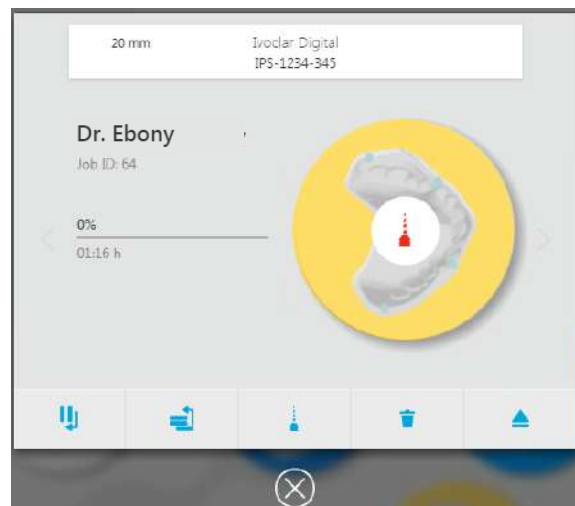

2. Tap on the symbol: 

- ➔ The milling job is set to the first position in the machining sequence (if a milling job is currently being processed: then after the running milling job).

## 8.5 Starting the milling job

You can start the milling job in any main menu.

- ☑ For at least one milling job, all tasks related to equipment and milling jobs have been carried out (“Managing discs and blocks”, page 111, and “Configuring and managing tool magazines and tools”, page 1).
- ☑ The cleaning status of the unit is OK (“Cleaning and Maintenance Work for the User”, page 154).

- ▶ Tap the icon in the quick access bar:

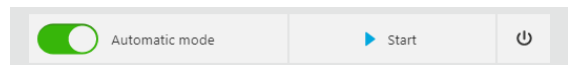

- ➔ The milling jobs are processed in the defined order.
- ➔ The milling progress of the running job is displayed.

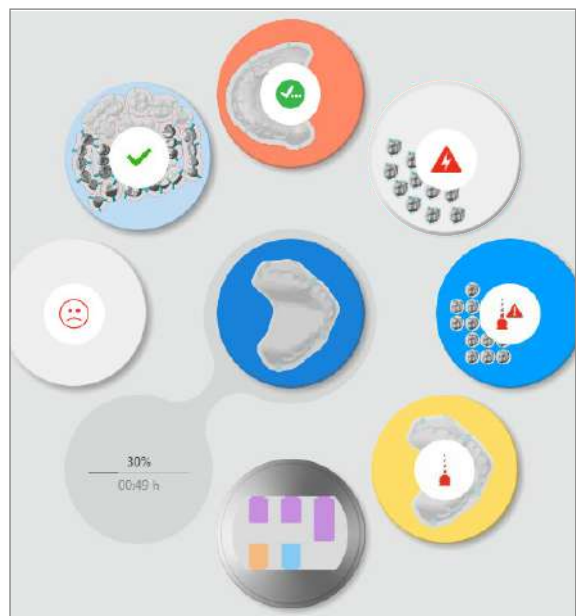

### 8.5.1 Stopping the milling process of the running milling job

You can stop a running milling job in any main menu. The milling job is deleted by the milling machine, but can again be transferred to the milling machine via the “PrograMill CAM”.

- ☑ One milling job is processed.
1. Tap the symbol in the quick access bar:

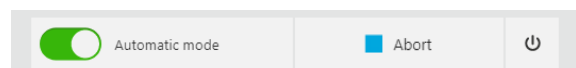

2. Confirm the confirmation prompt.  
The running milling job is stopped.

### 8.5.2 Pausing the processing of the milling jobs after the current milling job and then continuing again

You can set the execution of the milling jobs so that the running milling job is processed, but the subsequent milling jobs take a break until you give the start command.

- One milling job is processed.
- At least one more milling job is in the processing queue.

1. Tap on the specific milling job.

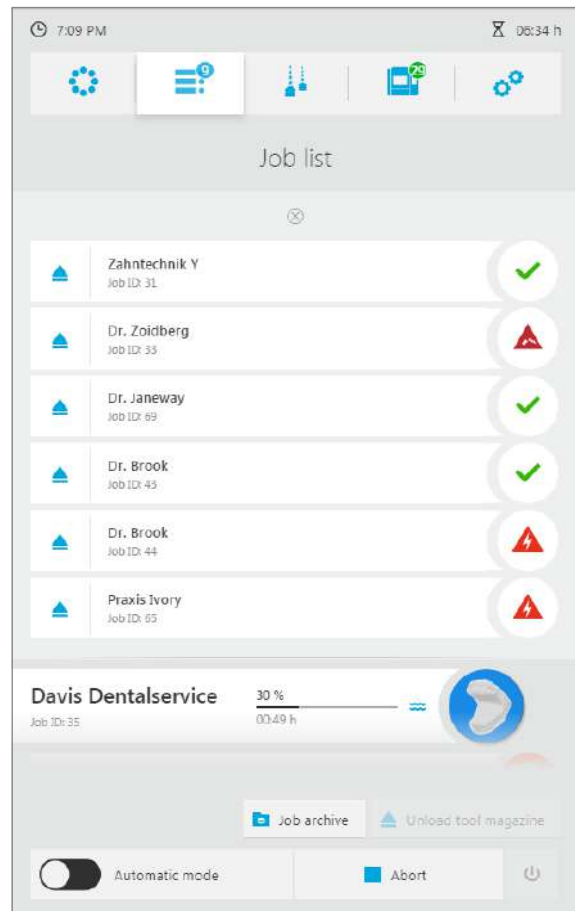

A detailed view of the milling job is displayed:

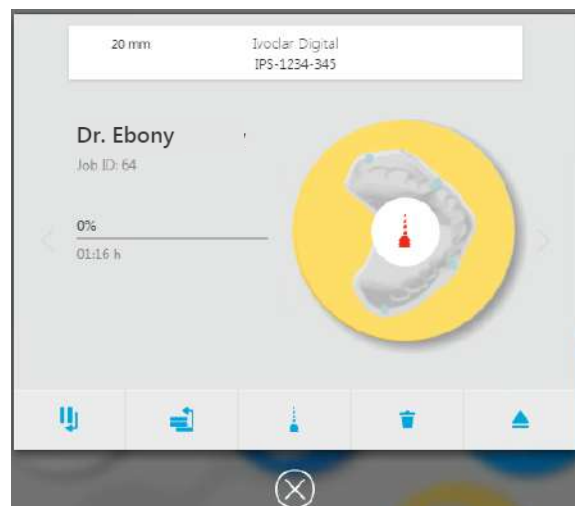

2. Tap on the symbol: 

  - ➔ The current milling job is processed until it is complete.
  - ➔ Once the current milling job has finished, the machine stops.
  - ➔ To continue the execution of the milling jobs, you can start the next job in the list as usual ("Starting the milling job", page 133).

### 8.6 Finishing/ejecting a completed milling job

#### 8.6.1 Completing the milling job and removing the finished restoration

! If a milling job in wet operation is followed by another milling job in dry operation, the machine automatically dries the milling chamber in between. Make sure to wait until this drying step is complete before completing the milling job that has just been processed.

! If dry processing of PMMA is followed by a milling job in wet operation, the milling chamber requires manual cleaning ("Cleaning the milling chamber and the seal of the front flap", page 157).

#### Completing the milling job

- The specific milling job is processed.
- No milling jobs are processed which require the disc or block holder and the respective disc or blocks.
- You are in the main menu [Job list].

1. Tap on the symbol over the processed milling job:

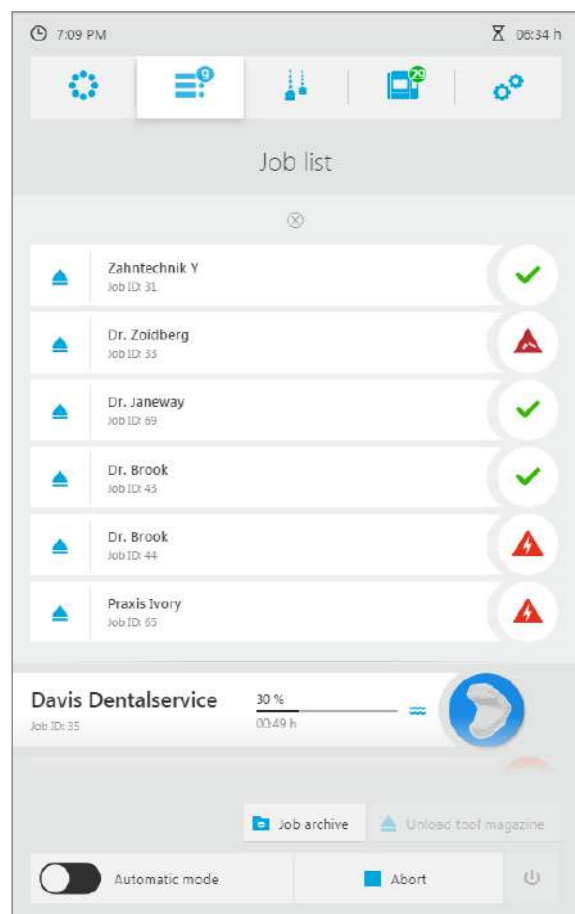



The list of all processed, not yet ejected milling jobs is displayed.

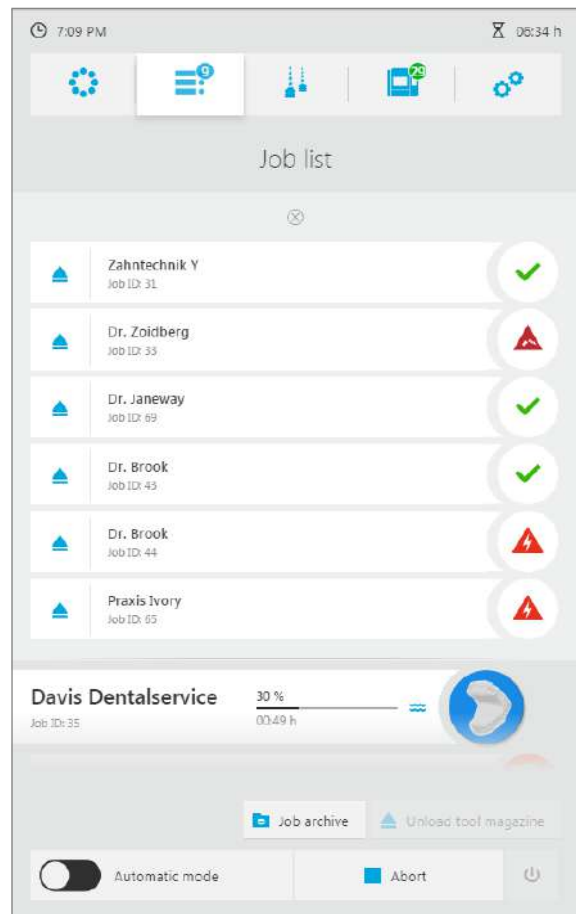

2. In the list of successfully processed milling jobs, tap the desired milling job on the symbol:



- ➔ The milling job is completed.
- ➔ The disc or block holder with the finished restoration is brought into the removal / insertion position in the material changer.



Completed and failed milling jobs can be viewed later in the [Job archive] sub-menu ("Sub-menu [Job archive] (depends on version)", page 71).

### Opening the material changer

- ! The illustrations in the following section show the standard disc holder. The procedure is identical for standard disc holders, Digital Denture and IPS e.matrix.

- ▶ Open the material changer.



### Removing disc or block holders from the material changer

- ! The illustrations in the following section show the standard disc holder. The procedure is identical for standard disc holders, Digital Denture and IPS e.matrix.

- ▶ Grasp the disc or block holder at the bracket (1) and remove it from the material changer.

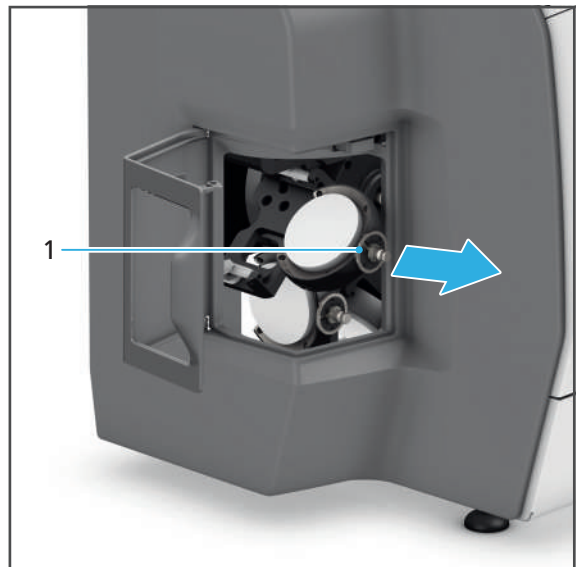

**Standard disc holder / Digital Denture: Removing the disc from the disc holder (zirconium oxide, PMMA /DCL, wax)**



The procedure for the materials is the same for both PMMA and wax in both the standard disc holder and the Digital Denture method. Therefore, the following instructions apply for both material types / holder types.

1. Unscrew the screws (1) using a torque wrench (zirconium oxide and wax: 0.45 Nm, PMMA: 2.8 Nm).

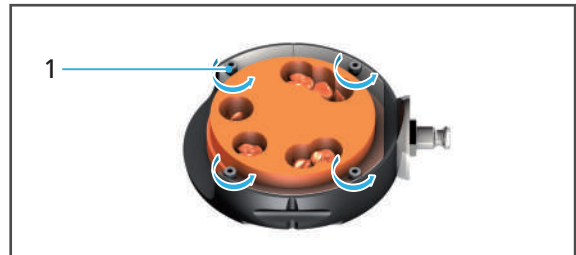

2. Remove outer ring (2).
3. Remove the disc (3) from the disc holder (4).

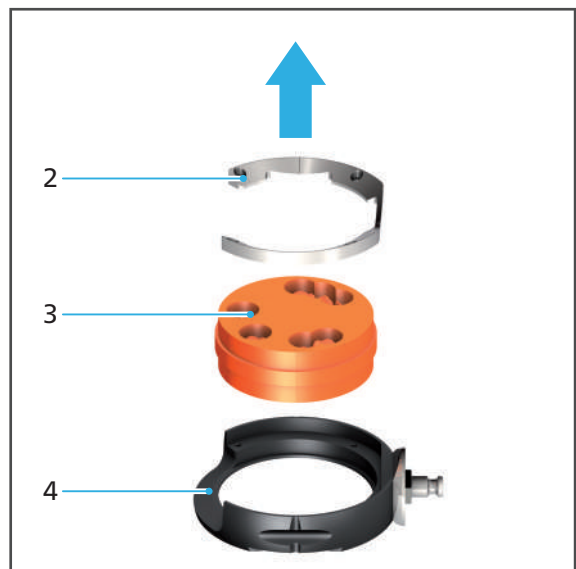

### Standard disc holder: Removing the disc from the disc holder (cobalt chrome, titanium)

1. Unscrew the screws (1) using a torque wrench (2.8 Nm).

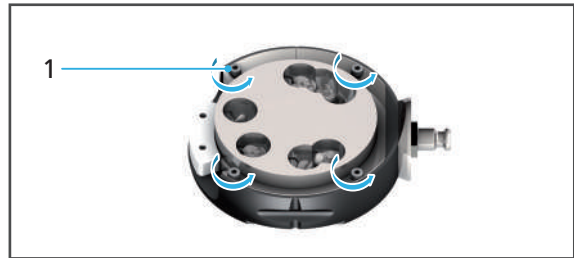

2. Remove outer ring (2).
3. Remove the disc (3) from the disc holder (5).
4. Remove the RFID container (4) from the disc holder (5).

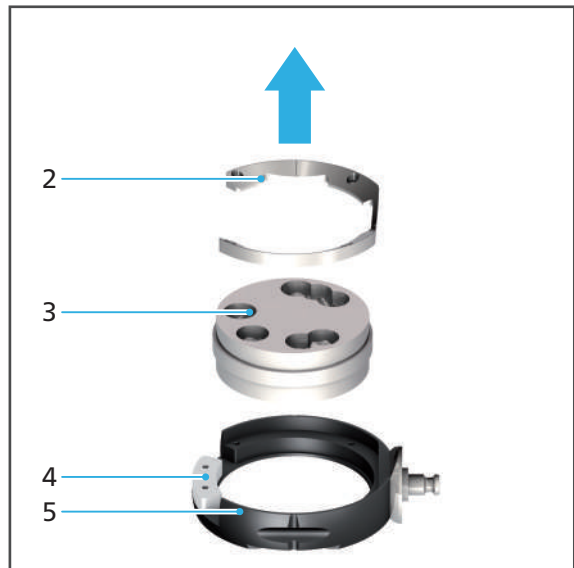

### IPS e.matrix: Removing blocks from the block holder

1. Unscrew the screws (1) using an Allen key (2.5 mm).
2. Remove the restorations (2) from the brackets in the block holder.

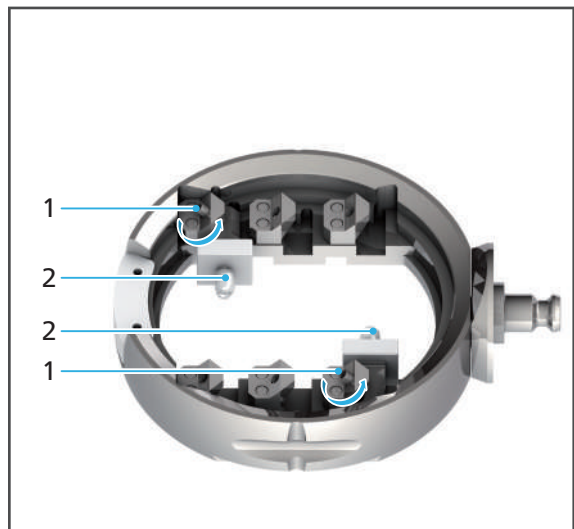

### Closing the material changer



The illustrations in the following section show the standard disc holder. The procedure is identical for standard disc holders, Digital Denture and IPS e.matrix.



**CAUTION! Finger caught between material changer flap and machine when closing the material changer flap.**

Risk of crushing.

► Close the material changer carefully.

1. If required, reassemble the disc or block holders and reinsert.
2. Close the material changer.



### 8.6.2 Cleaning the restoration



**WARNING! Insufficient cleaning of the restoration before insertion.**

The restoration falls in the patient's mouth. Risk of aspiration or swallowing.

Coolant fluid residues on the restoration. Nausea or allergy.

Damage to the restoration during further processing.

► Clean the restoration before further processing.

► Clean the restoration according to the specifications in the documentation of the respective disc or block (depending on the material type).

### 8.7 Displaying the Job Archive (depends on version)

 It depends on the software version installed on your device whether the operating panel of your milling machine has this function or not.

In the Job Archive you can see all completed milling jobs.

You can sort the milling jobs according to:

- Date (tab [Date])
- Status (tab [Status])
- Processing duration (tab [Time])
- Client (tab [Client])

You are in the main menu [Job list].

1. Tap on the key [Job archive].

The Job Archive is displayed (“Sub-menu [Job archive] (depends on version)”, page 71):

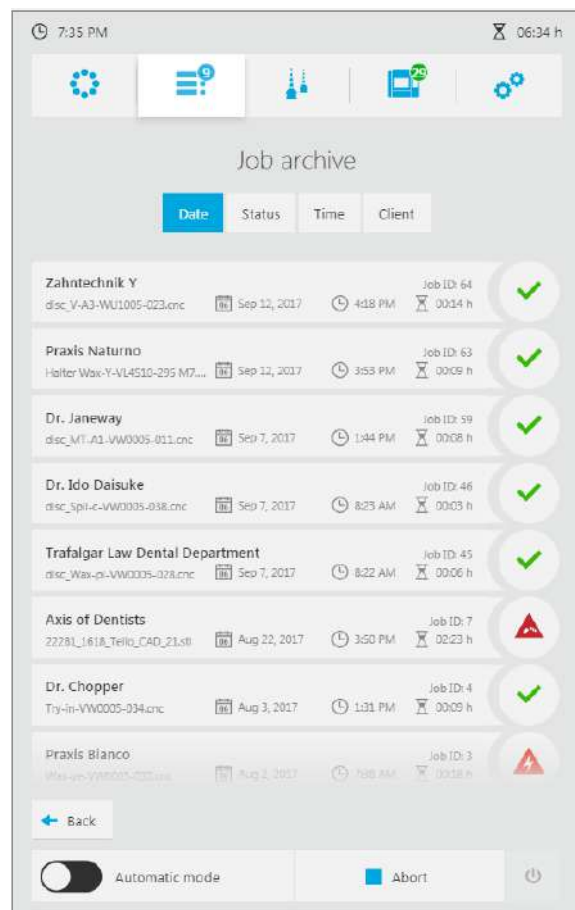

2. Select the tab for the desired form of sorting ([Date], [Status], [Time] or [Client]).

➔ The milling jobs are then sorted accordingly.

! By tapping on [Back] you will return to the main menu [Job list].

### 8.8 Shutting the device down and switching it off

**NOTICE! Switching the device off during a running milling job.**

The milling machine stops in an uncontrolled manner. The milling arm stands incorrectly.

Danger of collision in the milling chamber during subsequent restart of the device and thus damage to the device.

Damage to the disc or block.

- ▶ Do not pull the power supply plug during active processing.
- ▶ Do not switch off the device during operation with the on/off switch.
- ▶ Wait until the active milling processes have finished.

☑ All active milling jobs have been successfully completed.

1. In the operating panel, tap on the icon  in the Quick Access Bar.  
The device will shut down.

2. Switch the on/off switch (8) from I to 0.

➔ The device is switched off and without electricity.

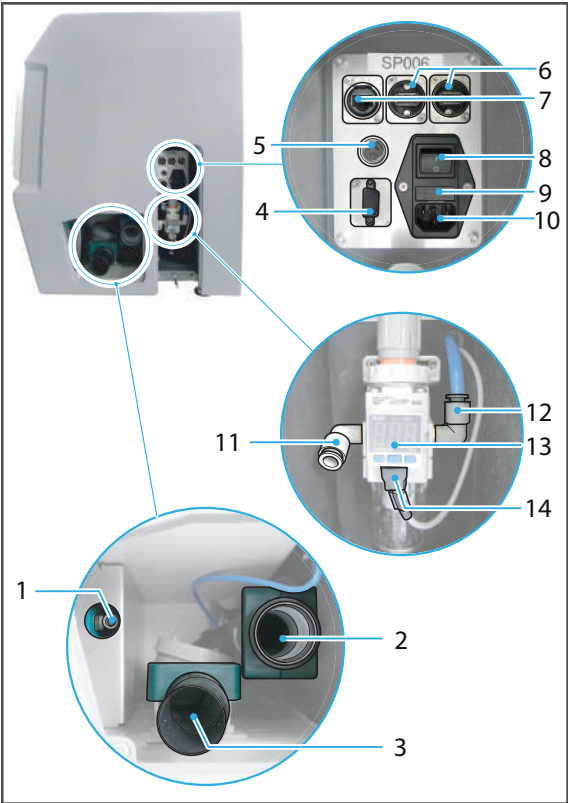

## 9 Device Messages and Troubleshooting



The device informs you about the state of your device, pending tasks and problems via displays and messages in the operating panel. In the event of an error, first check the displays in the operating panel ("Messages and warnings in the operating panel", page 144).

Please also use the following error table for troubleshooting ("Troubleshooting / error table", page 150).

If you cannot solve problems with the help of the information in the operating panel and the following sections, please contact your authorized service partner.

---

### 9.1 Messages and warnings in the operating panel



The device informs you about the mode it is in (e.g. tool change) as well as about any errors and warnings. They are displayed as messages in the operating panel.

Always follow the instructions in the operating panel which will guide you through the respective tasks to be carried out step by step.

---

In the title bar, messages are displayed in blue (1) and warnings on certain machine aspects (milling jobs, machine, settings) are displayed in green (2):

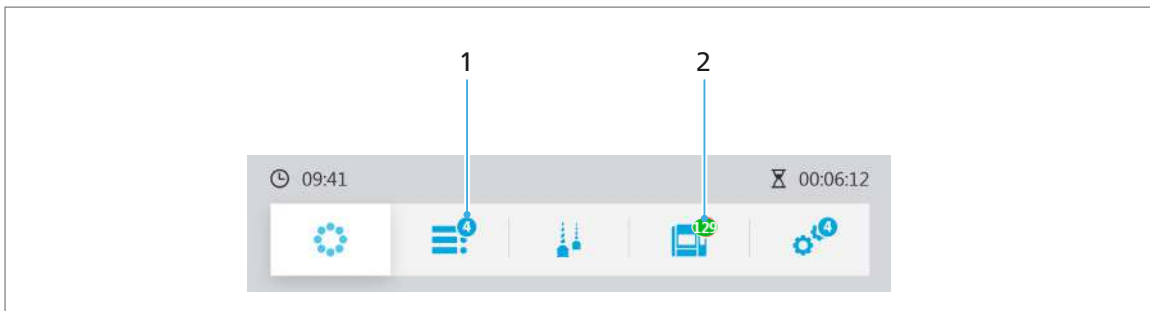

Messages (1) refer to situations that require the intervention of the user, but which are not critical for the system and the milling procedure (inserting tools, ejecting completed milling jobs, etc.).

Warnings (2) refer to situations that lead to a stop of the milling procedure or prevent the start of a milling procedure (open flaps, suction unit not connected, etc.). These problems need to be solved before the milling procedure can be continued. The above example is a machine-related issue. Therefore, the warning symbol (2) is displayed for the main menu [Status].



In each main menu, the critical points are indicated by red or orange warning symbols / markings in coloured font:

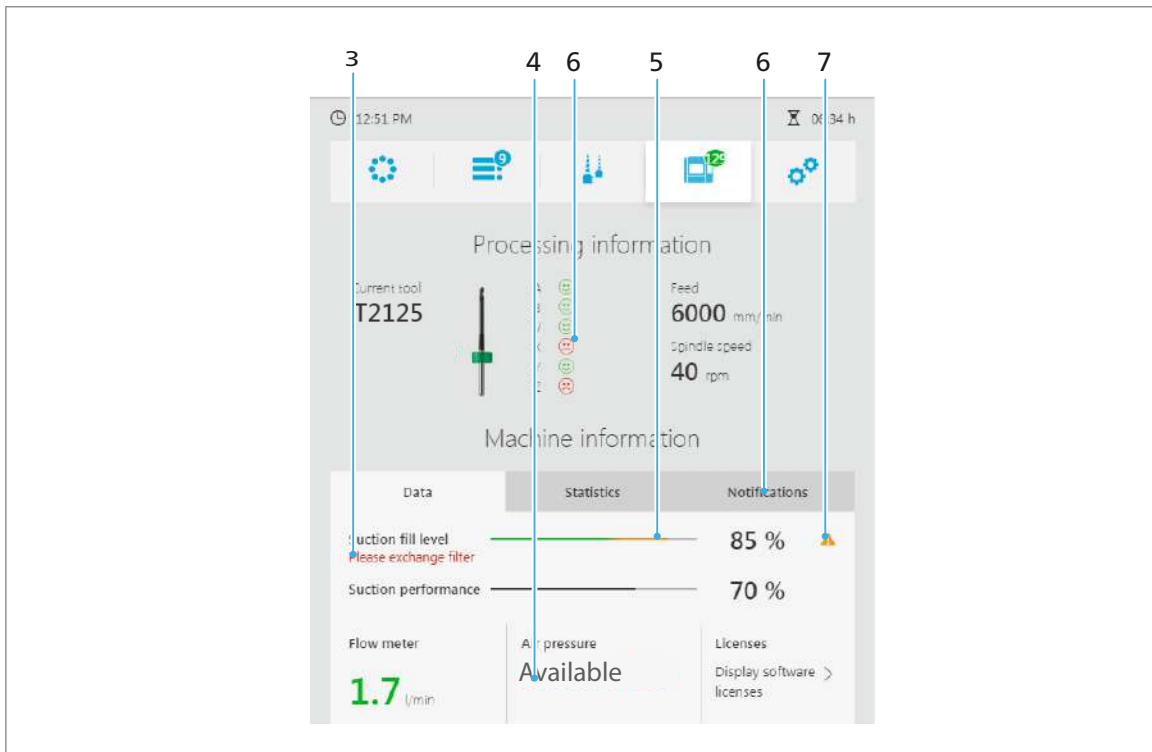

Red or orange markings / coloured font (3-5 and 7) show the importance of the error / problem (orange: intervention required promptly, red: critical, intervention immediately required).

In the tab [Notifications], notifications and error messages can be displayed and confirmed ("Displaying and editing notifications and error messages", page 89).

Warnings or messages that affect the system as a whole are displayed in colour (8) above the title bar. In addition to the colour marking, a text message is displayed:

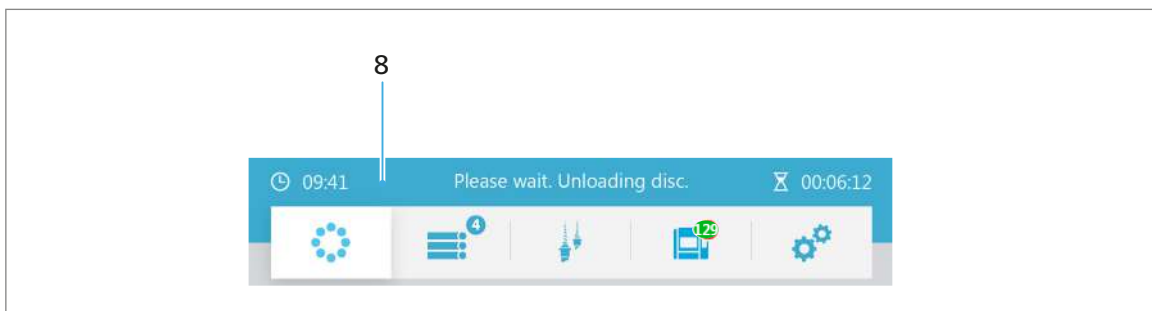

## Device Messages and Troubleshooting

In some cases, critical errors are also displayed in the form of pop-overs with corresponding warning symbols and notes on the solution (e.g. during the initialization of the system, see "Switching the device on for the first time", page 55):



Messages during initialization:

Message	Description	Rectification
Please close the front flap.	The front flap of the device is open. For safety reasons, the device can only be operated when the flap is closed.	<ul style="list-style-type: none"> <li>• Check/ close flap.</li> <li>• Initialization continues.</li> </ul>
Air pressure too low. Please check.	The compressed air supply is interrupted or insufficient. The device can only be operated if the compressed air supply is sufficient.	<ul style="list-style-type: none"> <li>• Connect to compressed air.</li> <li>• Confirm the message with [Restart] in the operating panel of the milling machine.</li> <li>• Initialization starts again.</li> </ul>

## 9.2 Conducting the calibration procedure

From time to time, a calibration of the axes is necessary. This is indicated by means of red smileys in the main menu [Status]:



- ☑ You are in the main menu [Status].
- 1. Select [Add calibration job] in the menu.

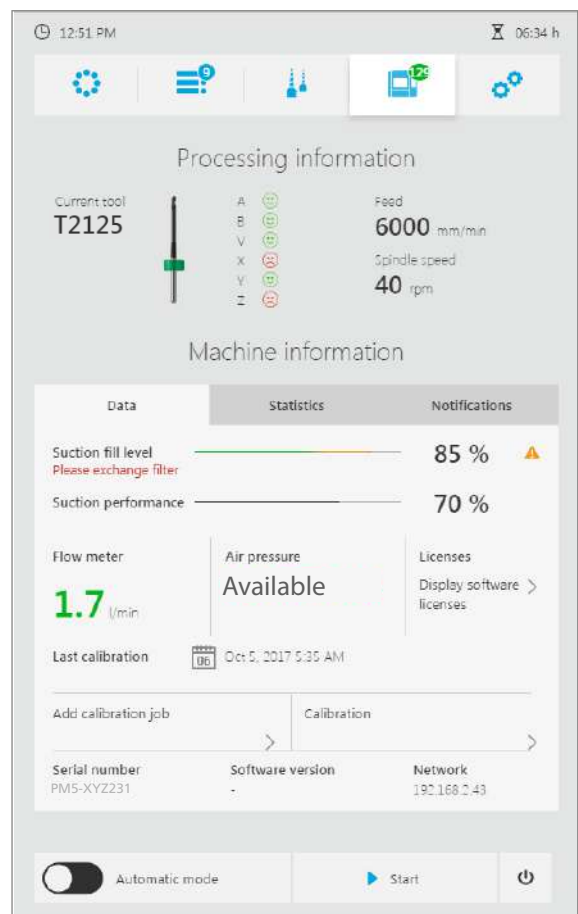

The respective milling job is created in the main menu [Job list].

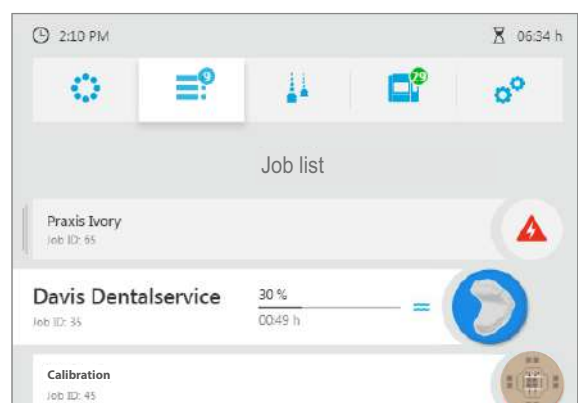

## Device Messages and Troubleshooting

---

2. Prepare and insert the test specimen blank like a normal disc ("Managing discs and blocks", page 111).
3. Insert the required tool ("Configuring and managing tool magazines and tools", page 1).
4. Process the milling job ("Starting the milling job", page 133).
5. Remove the test specimen blank ("Finishing/ejecting a completed milling job", page 136).
6. Select main menu [Status].
7. Select [Calibration] in the menu.  
The window [Calibration] is displayed.
8. Measure the test specimen blank and enter the values in the respective fields.



You can display the last calibration values via [Show values].

---

9. Select [Confirm].  
The values are transferred.  
Calibration is started.



- ➔ Calibration is completed.



- If the calibration is aborted due to the incorrect entry of the values and the corresponding error message is displayed, re-enter the values and re-start calibration as indicated above.
- If the values deviate significantly from the standard values, a corresponding message will be displayed once the values have been transferred. Confirm the message to start the calibration, or re-enter the values.

### 9.3 Troubleshooting / error table

Error	Possible reasons	Solution
Machine won't start	Power supply is not connected or has been interrupted. Power failure.	<ul style="list-style-type: none"> <li>• Check power supply and restore if necessary ("Connecting the device to the power supply", page 53).</li> <li>• Switch machine on (again).</li> <li>• If the problem continues: Please contact your authorized service partner.</li> </ul>
Switched on machine does not respond to input via the operating panel.	No network connection	<ul style="list-style-type: none"> <li>• Check network connection and restore if necessary.</li> <li>• If the problem continues: Please contact the in-house technician.</li> </ul>
	Necessary updates have not been downloaded.	<ul style="list-style-type: none"> <li>• Download updates ("Showing software version and performing software update", page 90)</li> <li>• If the problem continues: Please contact your authorized service partner.</li> </ul>
The machine does not continue to work.	Power supply has been interrupted. Power failure.	<ul style="list-style-type: none"> <li>• Check power supply and restore if necessary ("Connecting the device to the power supply", page 53).</li> <li>• Switch the machine off and then on again. Follow the instructions in the operating panel.</li> <li>• If the problem continues: Please contact your authorized service partner.</li> </ul>
	Fault in the machine	<ul style="list-style-type: none"> <li>• Please contact your authorized service partner.</li> </ul>
Insufficient extraction output	Broken restorations in the backwater flap valve of the milling machine	"Checking/cleaning the backwater flap", page 167

## Device Messages and Troubleshooting

---

Error	Possible reasons	Solution
Water loss	The milling machine and tank tubes are not correctly connected.	<ul style="list-style-type: none"> <li>• Check tube connections (“Preparing the PrograMill Tank and Filter and connecting to the device”, page 48).</li> </ul>
	Tank defect	<ul style="list-style-type: none"> <li>• Place the machine out of order and unplug from the power supply.</li> <li>• Please contact your authorized service partner.</li> </ul>
No milling jobs are shown in the job list.	No milling jobs have been transmitted from the PrograMill CAM.	<ul style="list-style-type: none"> <li>• Transfer milling jobs to the milling machine (again).</li> </ul>
	No network connection	<ul style="list-style-type: none"> <li>• Check network connection and restore if necessary.</li> <li>• Transfer milling jobs to the milling machine (again).</li> <li>• If the problem continues: Please contact the in-house technician.</li> </ul>

## Device Messages and Troubleshooting

Error	Possible reasons	Solution
Milling jobs won't start.	Tasks / To-dos haven't been finished:	
	None or incorrect tools / discs / blocks have been inserted for the milling job.	<ul style="list-style-type: none"> <li>• Insert a suitable tool / disc / block ("Using new tools and configuring a tool magazine", page 98 and "Inserting the required discs and blocks", page 113).</li> </ul>
	The tank is empty/not connected, filter is full/not connected, no PrograMill Fluid coolant concentrate was used.	<ul style="list-style-type: none"> <li>• Check tank and filter ("Preparing the PrograMill Tank and Filter and connecting to the device", page 48).</li> </ul>
	Suction unit not connected	<ul style="list-style-type: none"> <li>• Check suction unit connections ("Setting up and connecting the PrograMill Suction Unit or any other extraction system (can be ordered separately)", page 47).</li> <li>• Check the suction unit settings in the operating panel ("Tab [Data]", page 84).</li> </ul>
Milling job indicates missing tool, even though a tool has been inserted.	Compressed air is not connected or set incorrectly	<ul style="list-style-type: none"> <li>• Check compressed air supply ("Connecting the compressed air supply to the device", page 52).</li> <li>• Check the compressed air supply in the operating panel ("Tab [Data]", page 84).</li> </ul>
	Wrong tool was configured for the milling job	<ul style="list-style-type: none"> <li>• Check the tool magazine and configuration in the operating panel ("Using new tools and configuring a tool magazine", page 98).</li> </ul>
Tool has been inserted in the wrong position in the tool magazine		



Error	Possible reasons	Solution
Tool broken	Tool service life has been exceeded.	<ul style="list-style-type: none"> <li>Eject tool ("Removing unnecessary, worn or defective tools", page 104).</li> <li>Insert correct tool ("Using new tools and configuring a tool magazine", page 98).</li> <li>If the magazine cannot be removed from the unit or the tool is stuck: Please contact your authorized service partner.</li> </ul>
	Construction error in the CAD software	<ul style="list-style-type: none"> <li>Check the construction in the CAD and CAM software.</li> </ul>
	Error in the preparation or milling path calculation in the PrograMill CAM	<ul style="list-style-type: none"> <li>Transfer milling jobs to the milling machine (again).</li> </ul>
Disc / block not found	Non-approved discs / blocks without a suitable RFID label or RFID container	<ul style="list-style-type: none"> <li>Eject holder ("Removing no longer required or defective discs and blocks", page 125).</li> </ul>
	Zirconium oxide, PMMA, wax: RFID label damaged	<ul style="list-style-type: none"> <li>Check holder, disc / block, RFID container and RFID label.</li> </ul>
	IPS e.matrix, CoCr, Ti: The RFID container is not inserted in the block holder.	<ul style="list-style-type: none"> <li>Depending on the situation: Insert new disc/ new block, insert RFID container and re-insert holder into the device ("Inserting the required discs and blocks", page 113).</li> </ul>
Disc / block is stuck in the device.	Disc / block incorrectly inserted. Fault in the machine	<ul style="list-style-type: none"> <li>Please contact your authorized service partner.</li> </ul>
Deviations in the axis geometry	Collision run due to tool breakage	<ul style="list-style-type: none"> <li>Conduct milling of the calibration geometry "Conducting the calibration procedure", page 147).</li> <li>Notice: Insert max. 1 test specimen blank into the changer!</li> </ul>

# 10 Cleaning and Maintenance Work for the User



This chapter deals exclusively with the cleaning of the appliance.

For information on cleaning the supplied components, such as the PrograMill Suction Unit or the PrograMill Base cabinet, refer to the operating instructions of the relevant components ("Supporting documents", page 9).

---



**DANGER! Improper cleaning and maintenance of the appliance. Failure to observe the specified cleaning intervals defined in these instructions.**

Risk to the patient and the user.

Damage to the device.

- ▶ Only carry out work on the device described in this chapter and assigned to the user.
  - ▶ Always carry out the cleaning tasks at the specified intervals.
- 

## 10.1 Cleaning and maintenance table

To ensure safe operation of your device, carry out cleaning and maintenance work according to the following table at the specified intervals. In addition, observe the notifications in the operating panel.

Always prepare your device accordingly before processing ("Preparing for cleaning", page 156).

Interval	Duties	Responsible person	Reference
Daily	Cleaning the milling chamber	User/operator	"Cleaning the milling chamber and the seal of the front flap", page 157
	Cleaning the measuring probe	User/operator	"Cleaning the measuring probe", page 159
	Drawer under the milling chamber (service flap)	User/operator	"Cleaning the drawer under the milling chamber (service flap)", page 160
	Checking and emptying the sieve insert on the PrograMill Tank	User / operator	"Checking and emptying the sieve insert on the PrograMill Tank", page 162

## Cleaning and Maintenance Work for the User

Interval	Duties	Responsible person	Reference
Weekly	Cleaning the spindle and collet	User/operator	"Cleaning the collet", page 164
	Cleaning the material changer	User/operator	"Cleaning the material changer", page 166
	Servicing the compressed air supply (water trap)	User/operator	"Servicing the compressed air supply", page 167
	Cleaning the tool magazine	User/operator	-
	Checking/cleaning the backwater flap	User/operator	"Checking/cleaning the backwater flap", page 167
Monthly	Housing and front flap seal	User/operator	"Cleaning the housing", page 169
According to the message in the operating panel	Changing the coolant fluid in the tank	User/operator	"Changing the coolant fluid in the PrograMill Tank", page 170
	Changing the PrograMill filter cartridge for the tank	User/operator	"Changing the PrograMill filter cartridge for the tank", page 173
	Changing the filter in the PrograMill Suction Unit	User/operator	See the Operating Instructions for the PrograMill Suction Unit (see "Supporting documents", page 9)

### 10.2 Preparing for cleaning

In order to clean the device and its components, it must be in stand-by mode.

1. Wait until the running jobs are completely processed.
2. For suction work, connect the tube with the crevice nozzle (included in the delivery form of the PrograMill Suction Unit, diameter 38 mm) to the connection (1) at the separator on the PrograMill Suction Unit.

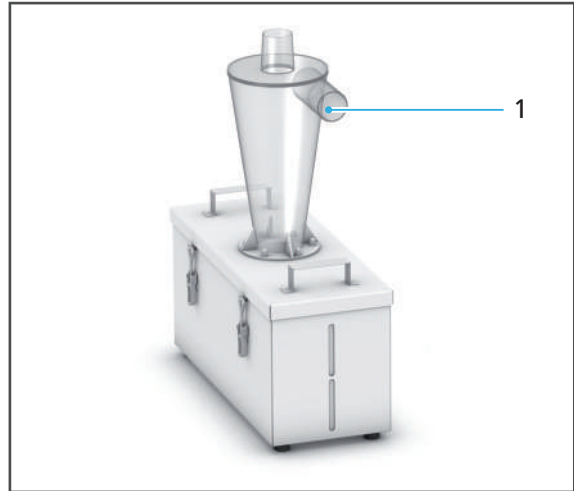

- ➔ Device is in the stand-by mode.
- ➔ The device flaps can be opened.
- ➔ If necessary, cables and tubes can be detached from the components.

## 10.3 Cleaning the milling chamber and the seal of the front flap

---



### **CAUTION! Skin contact with the coolant concentrate.**

Skin irritation. Danger to the environment with leaking coolant fluid.

- ▶ When handling the coolant fluid and components which could contain the fluid (tank, collection container, etc.), wear gloves.
  - ▶ Observe the safety data sheet for the coolant concentrate PrograMill Fluid ("Supporting documents", page 9).
- 

### **NOTICE! Improper cleaning of the milling chamber with unsuitable equipment and cleaning agents.**

Damage to sensitive components in the inner chamber.

Damage / scratching of the viewing window on the milling chamber flap.

- ▶ Do not clean with or enter the milling chamber using brushes, tools, sponges with metal components, or any cleaning equipment other than that specified in this chapter.
  - ▶ Only use soft towels, paint brushes, brushes or small brooms.
  - ▶ Do not use sharp, chlorine-containing cleaners. Only use mild, pH neutral cleaning agents.
  - ▶ To avoid damaging the sensitive components in the milling chamber, avoid strong pressure, scrubbing, rubbing and wiping.
  - ▶ Do not move, relocate or manipulate the cover between the milling chamber and the material and tool changer.
  - ▶ To avoid scratching and therefore clouding the window of the milling chamber, only clean the viewing window with a soft cloth dampened with tap water and a mild, pH-neutral detergent.
  - ▶ Do not wear jewellery such as rings, bracelets or watches when working on the appliance, especially when cleaning the milling chamber.
- 

The device is ready ("Preparing for cleaning", page 156).

1. Open milling chamber ("Opening the milling chamber", page 99).

---



Alternatively, you can also clean using a small, soft broom or a suitable brush.

---

## Cleaning and Maintenance Work for the User

---

2. Carefully vacuum the milling chamber to remove dust and residues.



3. Clean the viewing window (1) and the seal of the front flap (2) with a soft cloth, dampened with tap water and a mild, pH neutral detergent.

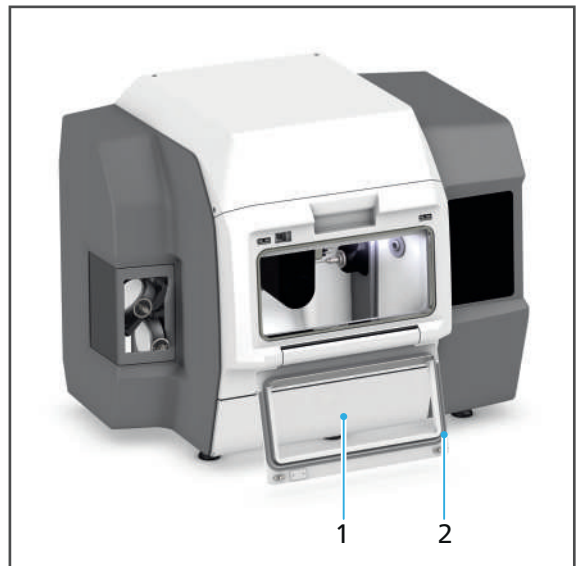

4. Close milling chamber ("Closing the milling chamber", page 103).

### 10.4 Cleaning the measuring probe

The work in the milling chamber can contaminate the measuring probe on the tool changer, so that it has to be cleaned:



When cleaning, observe the safety advice in the section "Cleaning the milling chamber and the seal of the front flap", page 157.

---

- ☑ The device is ready ("Preparing for cleaning", page 156).
  - ☑ Tool magazine has been removed from the device ("Selecting the tool magazine in the operating panel", page 98, "Opening the milling chamber", page 99, and "Removing the tool magazine", page 99).
  - ☑ Tool changer is located in the extended position in the milling chamber.
1. In order to remove the dust and residue from the measuring probe, gently clean the probe (1) with a brush.
  2. Inserting the tool magazine ("Inserting the tool magazine", page 103)

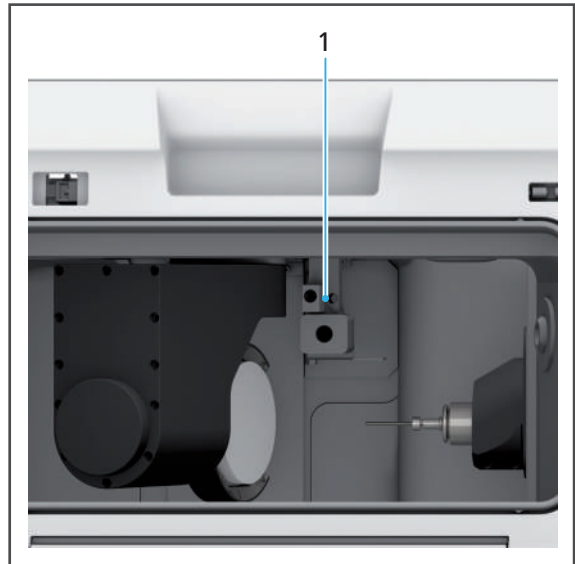

### 10.5 Cleaning the drawer under the milling chamber (service flap)

Behind the service flap on the front of the device is a drawer, in which chips generated during the milling process and excess coolant fluid are collected.

---

**NOTICE! Opening the service flap during a disc changing process.**

Emergency shut down. The arm of the material changer stands incorrectly.

Danger of collision in the milling chamber during subsequent restart of the device and therefore related damage to the device.

Damage to the disc or block.

- ▶ Wait until the active disc changing process has finished.
- 

**NOTICE! Operation without drawer insert.**

Danger to the environment due to leaking coolant fluid.

- ▶ Insert the drawer back into the designated space after cleaning.
- 

The device is ready ("Preparing for cleaning", page 156).

1. Open service flap.





2. Remove drawer.

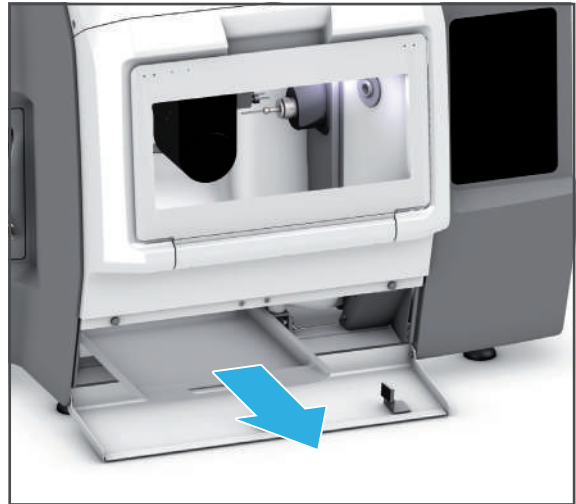

3. Dispose of the milling residues according to the specifications ("Supporting documents", page 9, documentation on the used discs / blocks and the PrograMill Fluid).
4. Clean with a soft cloth, dampened with tap water and a mild, pH neutral detergent and allow to dry.
5. Carefully vacuum the drawer to remove dust and residues.
6. Insert the drawer.

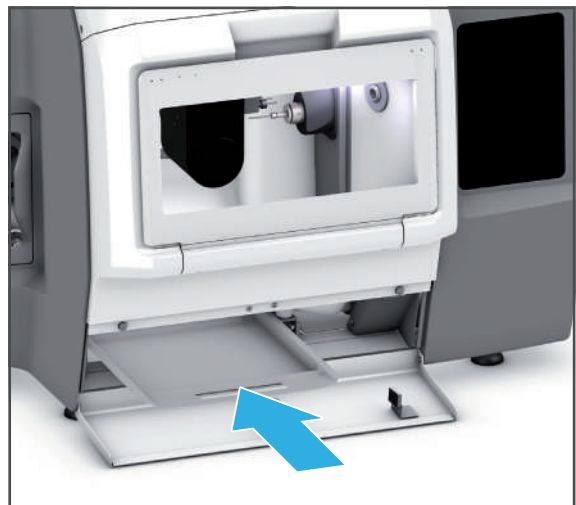

**CAUTION! Finger caught between the service flap and the machine when closing the service flap.**

Risk of crushing.

- ▶ Close the service flap carefully.

- 
7. Close the service flap.

### 10.6 Checking and emptying the sieve insert on the PrograMill Tank

The PrograMill Tank has an additional sieve insert for pre-filtering coarse milling residues.

The device is ready ("Preparing for cleaning", page 156)

1. Loosen the water outlet tube from the tank lid (1).

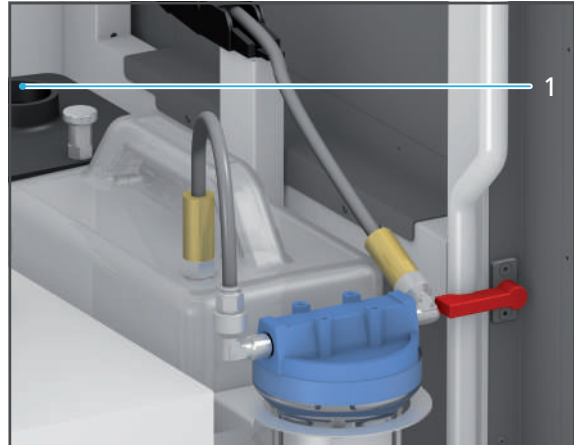

2. To unlock the lid, pull the lock upwards (2) and pull the lid off the tank in the direction of the arrow (3).



3. Remove the sieve insert (4).
4. Dispose of the milling residues from the sieve insert.
5. Rinse the sieve insert under running water and clean with a dry, soft cloth.

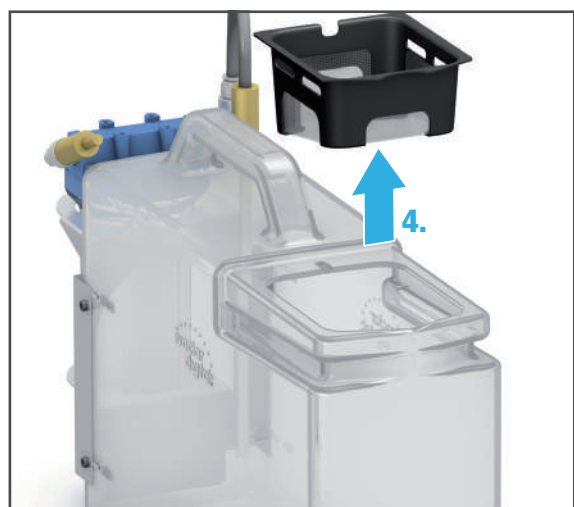

6. Replace the sieve insert (5).

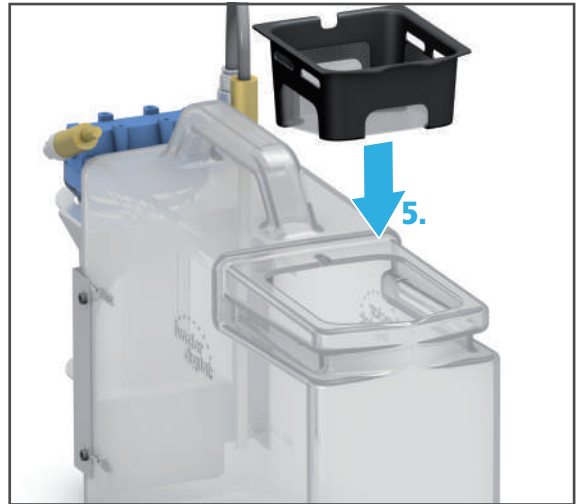

7. Put the lid onto the tank and slide it in the direction of the arrow until it locks (6) in place.

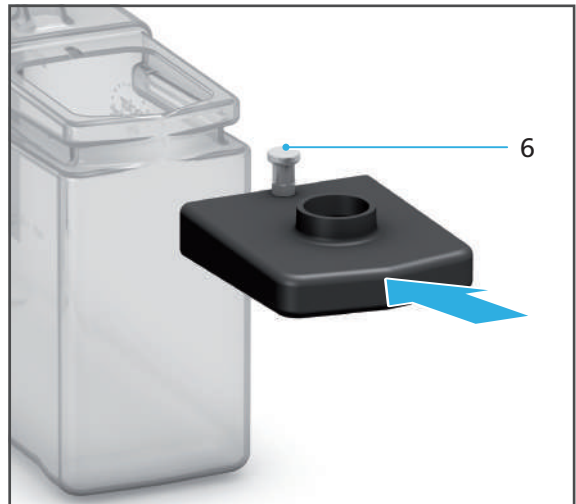

8. Connect the water outlet tube to the tank lid (7).

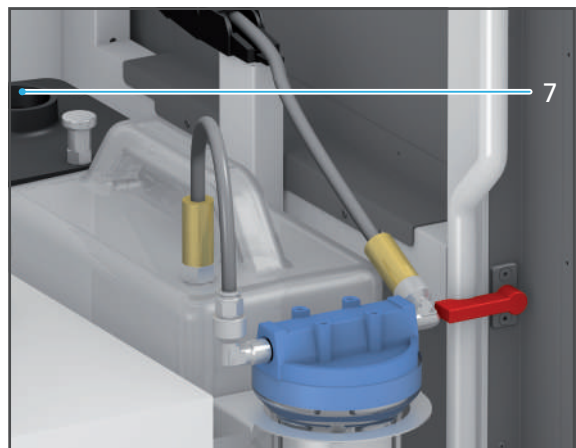

### 10.7 Cleaning the collet

- ☑ The device is ready ("Preparing for cleaning", page 156).
- ☑ You are in the main menu in the operating panel [Settings].
- 1. Select [Start spindle cleaning] in the menu.
- 2. Follow the instructions in the operating panel.
- 3. Open milling chamber ("Opening the milling chamber", page 99).
- 4. Unscrew the collet by hand using the knurled nut from the spindle service set.

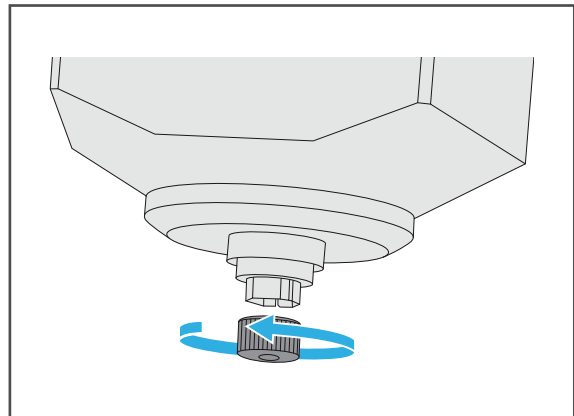

- 5. Clean the internal cones of the spindle with the cleaning cone from the spindle service set.

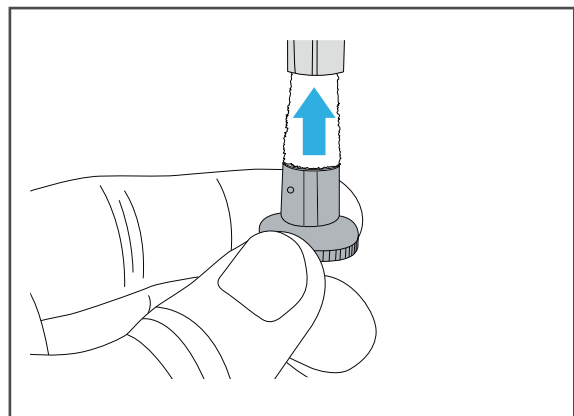

- 6. Clean the collet using the brush from the spindle service set, degrease it and make sure that the seals in the collet do not fall off.

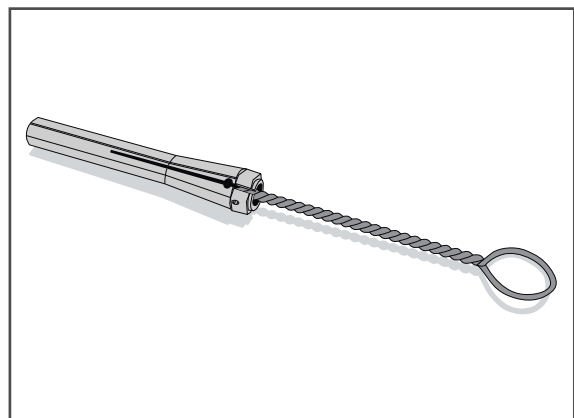

7. Take a small amount of the collet chuck grease from the spindle service set and apply it to the collet flanks (1).

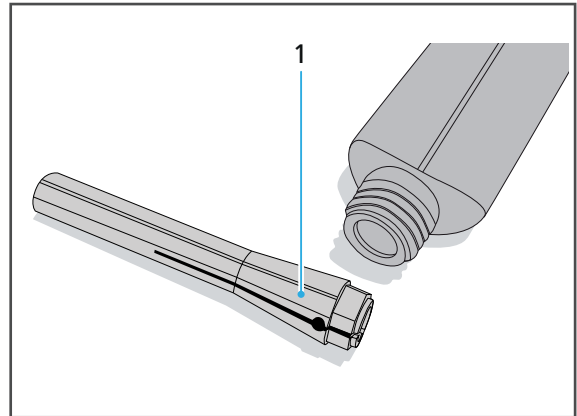

8. Screw the collet into the spindle until it stops using the screw-in piece.

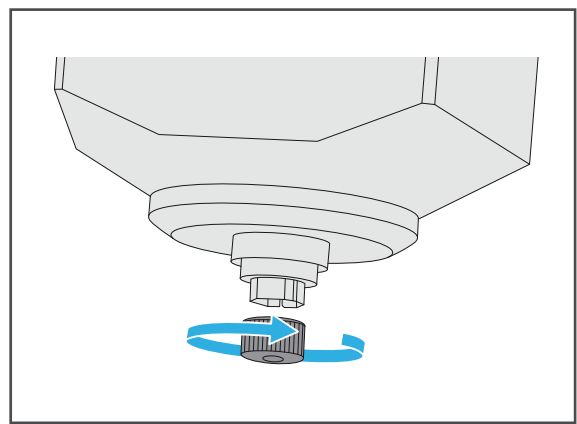

9. Follow the instructions in the operating panel.
10. Close milling chamber ("Closing the milling chamber", page 103).

### 10.8 Cleaning the material changer

---

**NOTICE! Improper cleaning of the material changer with unsuitable equipment and cleaning agents.**

Damage to sensitive components in the interior.

Damage / scratching of the viewing window on the material changer.

- ▶ Do not clean with or enter the material changer using brushes, tools, sponges with metal components, or any cleaning equipment other than that specified in this chapter.
  - ▶ Only use soft towels, paint brushes, brushes or small brooms.
  - ▶ Do not use sharp, chlorine-containing cleaners. Only use mild, pH neutral cleaning agents.
  - ▶ To avoid damaging the sensitive components in the material changer, avoid strong pressure, scrubbing, rubbing and wiping.
  - ▶ To avoid scratching and therefore clouding the window of the material changer, only clean the viewing window with a soft cloth dampened with tap water and a mild, pH-neutral detergent.
  - ▶ Do not wear jewellery such as rings, bracelets or watches when working on the appliance, especially when cleaning the material changer.
- 

The device is ready ("Preparing for cleaning", page 156).

1. Remove all disc or block holders and clean using a soft brush ("Placing the material changer in the removal / insertion position", page 125, "Opening the material changer", page 122, and "Removing disc or block holders from the material changer", page 138).
2. Carefully vacuum the material changer to remove dust and residues.
3. Clean the viewing window with a soft cloth, dampened with tap water and a mild, pH neutral detergent.
4. Insert disc or block holder if required ("Placing the material changer in the removal / insertion position", page 121, "Opening the material changer", page 122 and "Inserting the disc or block holder", page 123).

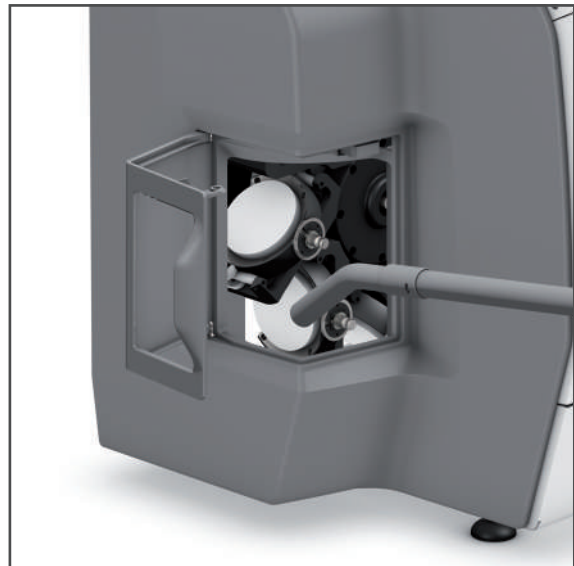

### 10.9 Servicing the compressed air supply

To service the compressed air supply, proceed as follows:

- ☑ The device is ready ("Preparing for cleaning", page 156).
- ☑ The small collection container is ready.
- 1. Check the water trap (2) at the compressed air supply (1) for accumulated liquid.
- 2. In the event of liquid accumulation:
  - a. Hold the collecting container under compressed air supply.
  - b. Open the drain screw at the water separator.
  - c. Collect the liquid.
  - d. Tighten the drain screw again.

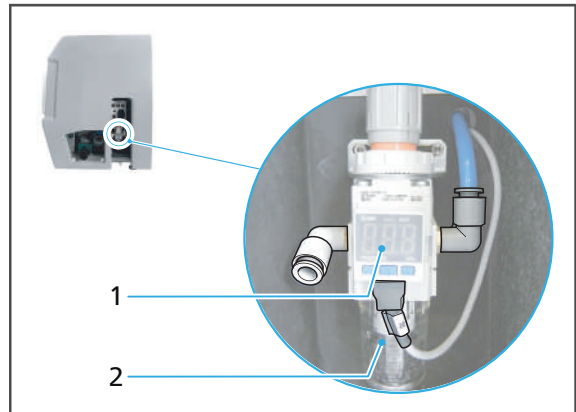

### 10.10 Checking/cleaning the backwater flap

Occasionally, broken restorations may become stuck in the backwater flap valve of the milling machine and therefore cause the suction capacity to reduce greatly.

If the suction power is too low during dry operation, check whether parts or residues have accumulated in front of the backwater flap.

---

**⚠ CAUTION! Skin or eye contact with milling dust.**

Irritation of skin or eyes.

- ▶ Wear a protective mask during cleaning in order to avoid inhaling milling dust, fumes or other dental material particles (half mask with protection class FFP3).
  - ▶ Wear gloves when cleaning.
- 

**⚠ CAUTION! Skin contact with the coolant fluid.**

Skin irritation. Danger to the environment with leaking coolant fluid.

- ▶ When handling the coolant fluid and components which could contain the liquid (collection container, hydraulic lines etc.), wear gloves.
  - ▶ Observe the safety data sheet for the PrograMill Fluid coolant concentrate, "Supporting documents", page 9.
-

## Cleaning and Maintenance Work for the User

---

1. Disconnect the service flap (1) from the connections on the right side.



2. Unscrew lid (2) and set aside.

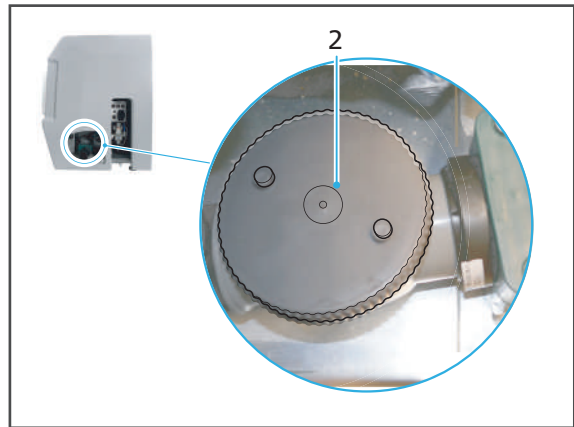

3. Vacuum the flap valve (4) housing.
4. Clean any coolant fluid residues with a soft cloth, dampened with tap water and a mild, pH-neutral detergent and allow to dry.
5. Make sure that the flap valve has free movement (3).
6. Attach the lid.
7. Connect the service flap to the connections on the right side.

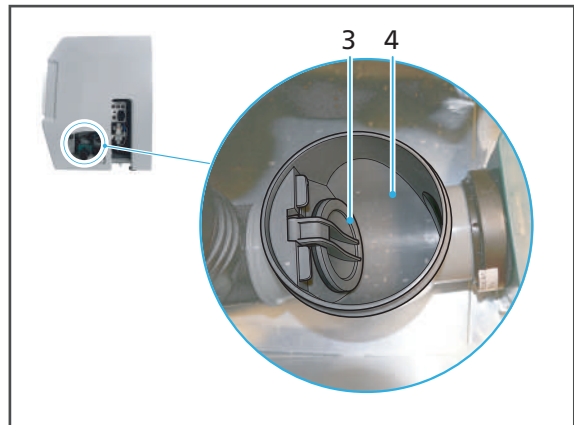



## 10.11 Cleaning the housing

---



**WARNING! Improper cleaning of the device. Voltage-carrying components come into contact with moisture. Voltage-carrying components are exposed.**

Danger of electrocution.

Damage to the device.

- ▶ Never remove the housing cover.
  - ▶ Ensure that no liquids or items enter into the inside of the device.
- 

**NOTICE! Improper cleaning of the housing with unsuitable equipment and cleaning agents.**

Damage / scratching of the viewing window on the flap.

- ▶ Do not use brushes, tools, sponges with metal components, or any cleaning equipment other than that specified in this chapter.
  - ▶ Do not use sharp, chlorine-containing cleaners. Only use mild, pH neutral cleaning agents.
  - ▶ Do not wear jewellery such as rings, bracelets or watches when working on the appliance.
- 

The device is ready ("Preparing for cleaning", page 156).

- ▶ Clean the housing with a soft cloth, dampened with tap water and a mild, pH neutral detergent.

### 10.12 Changing the coolant fluid in the PrograMill Tank

The device can only be operated with a correctly inserted, full tank and clean coolant fluid. Otherwise a fault report appears in the operating panel of the device and the milling procedure stops.

---

**⚠ DANGER! Coolant fluid has run into the electronics. Coolant fluid enters the water circulation.**

Danger of electrocution.

Damage to the device.

Danger to the environment.

- ▶ Ensure the connections and tubes are all secure and airtight.
- ▶ Dispose of the contents in the tank according to the specifications (see "Safety Data Sheet PrograMill Fluid", "Supporting documents", page 9).

---

**⚠ CAUTION! Skin contact with the coolant fluid /concentrate.**

Skin irritation.

Danger to the environment with leaking coolant fluid.

- ▶ When handling the coolant fluid and components which could contain the fluid (tank, filter etc.), wear gloves.
- ▶ Observe the safety data sheet for the coolant concentrate PrograMill Fluid ("Supporting documents", page 9).

---

**NOTICE! Operation of the unit without the addition of the coolant concentrate.**

Increased wear, reduced service life of the device and filter.

- ▶ Always add tap water to the PrograMill Fluid coolant concentrate as described below.

---

The device is ready ("Preparing for cleaning", page 156).

1. Loosen the water outlet tube from the tank lid (1).
2. Loosen the water inlet tube from the filter (arrow direction (2), labelled OUT on the filter lid).
3. **When using the PrograMill Base cabinet:** Remove the tank from the PrograMill Base cabinet (see Operating Instructions for the PrograMill Base, "Supporting documents", page 9).

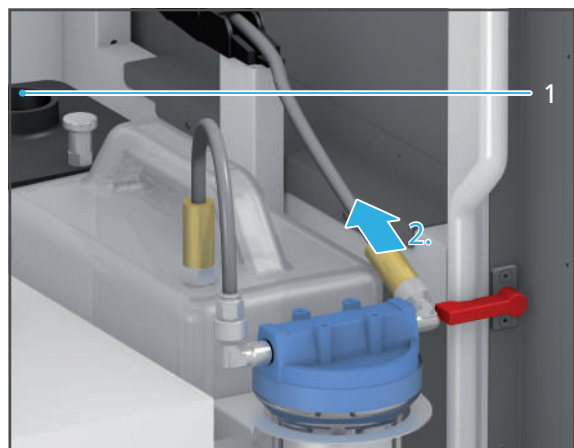

4. To unlock the lid, pull the lock upwards (3) and pull the lid off from the tank in the direction of the arrow (4).



5. Remove sieve insert (5).
6. Dispose of the contents in the tank according to the specifications (see Safety Data Sheet PrograMill Fluid).
7. Rinse the tank with fresh water, collect the water and dispose of according to the specifications.

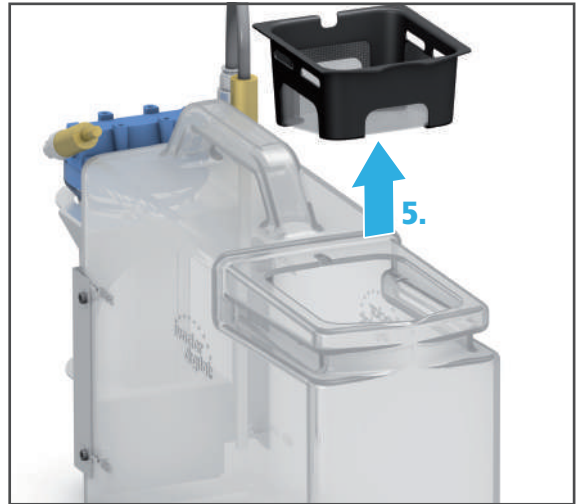

8. Fill the tank up to the fill level "max." (15 l) with tap water and PrograMill Fluid coolant concentrate (mixing ratio 7%).



## Cleaning and Maintenance Work for the User

9. Insert sieve insert (6).

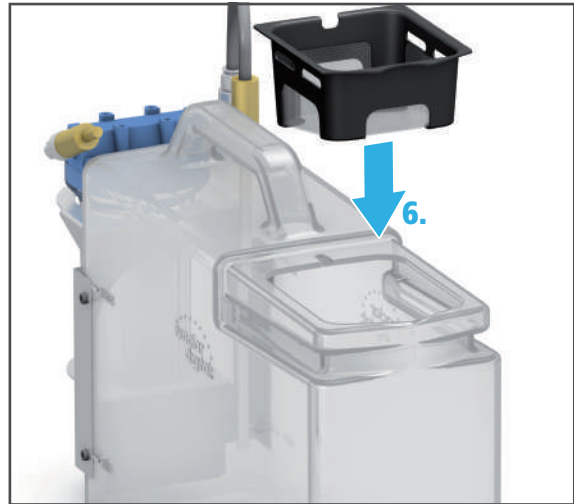

10. Place the lid on the tank and slide it in the direction of the arrow until it locks (7) in place.

11. **When using the PrograMill Base cabinet:** Position the tank in the PrograMill Base cabinet.



12. Connect the water outlet tube to the tank lid (8).

13. Connect the water inlet tube to the filter (arrow direction (9), labelled OUT on the filter lid).

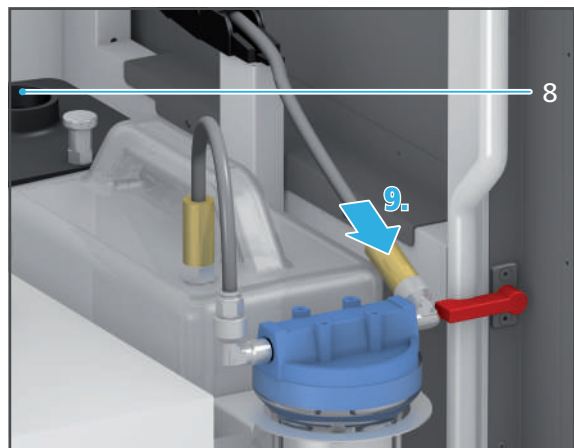

## 10.13 Changing the PrograMill filter cartridge for the tank

The device can only be operated with a clean filter / a clean filter cartridge. Otherwise a fault report appears in the operating panel of the device and the milling procedure stops.

---



**DANGER! Coolant fluid has run into the electronics. Coolant fluid enters the water circulation.**

Danger of electrocution.

Damage to the device.

Danger to the environment.

- ▶ Ensure the connections and tubes are all secure and airtight.
  - ▶ Dispose of the contents in the tank according to the specifications (see "Safety Data Sheet PrograMill Fluid", "Supporting documents", page 9).
- 



**CAUTION! Skin contact with the coolant fluid / concentrate.**

Skin irritation.

Danger to the environment with leaking coolant fluid.

- ▶ When handling the coolant fluid and components which could contain the fluid (tank, filter etc.), wear gloves.
  - ▶ Safety data sheet for the coolant concentrate PrograMill Fluid ("Supporting documents", page 9).
- 

**NOTICE! Rinsing the filter. Coolant fluid enters the water circulation.**

Damage to the device.

Danger to the environment.

- ▶ Do not rinse the filter, but instead, change and dispose of as described in this chapter.
- 



The tank / filter in the PrograMill Base cabinet is shown below.

---

## Cleaning and Maintenance Work for the User

☑ The device is ready ("Preparing for cleaning", page 156).

1. Loosen the connection line between filter and the tank (arrow direction (1), labelled IN on the filter lid).
2. Loosen the water inlet tube to the filter (arrow direction (2), labelled OUT on the filter lid).
3. Lift the filter out of the tank in the direction of the arrow (3).

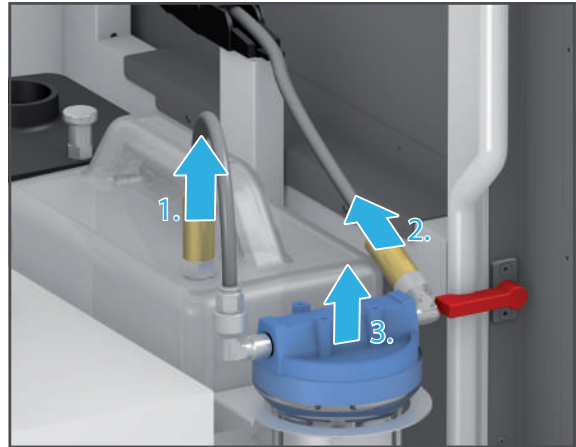

4. Turn and lift the lid (4) from the filter in the direction of the arrow.
5. Remove the filter cartridge (5) and dispose of according to country specific regulations.

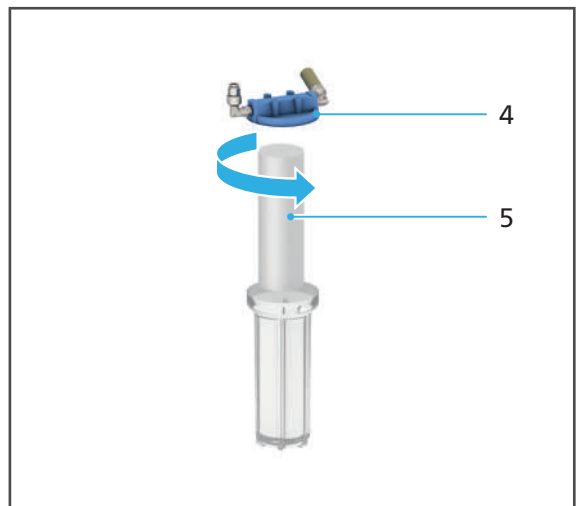

6. Rinse the filter container with fresh water, collect the water and dispose of according to the specifications (Safety Data Sheet PrograMill Fluid).
7. Insert new filter cartridge (7) into the filter (8).
8. Place the lid (6) back onto the filter (8) and turn in the direction of the arrow.

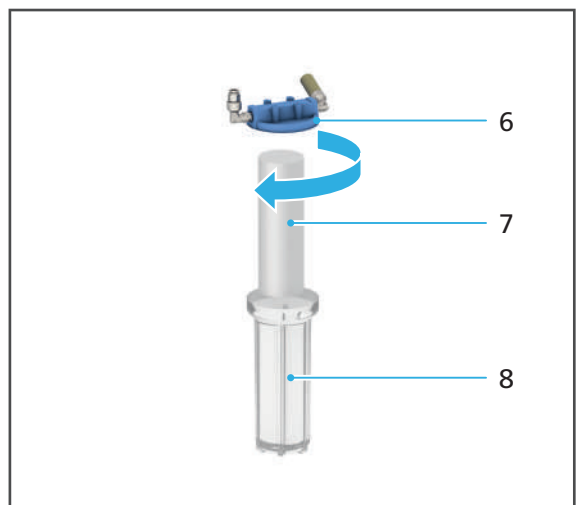

9. Place the filter into the tank (9).
10. Attach the connection line between the filter and the tank to the corresponding connection on the tank (arrow direction (10), labelled IN on the filter lid).
11. Connect the water inlet tube to the filter (arrow direction (11), labelled OUT on the filter lid).

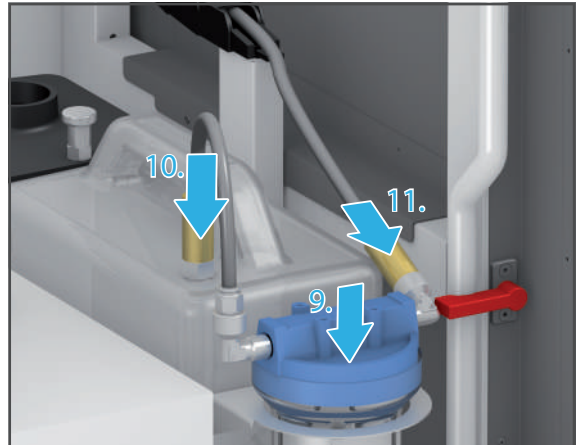

### 10.14 Finishing the cleaning procedure

1. Connect all cables and tubes (see relevant sections in "Initial Operation", page 46).
2. Close all flaps on the device.
3. If necessary, switch the device on ("Switching the device on for the first time", page 55).
4. Restore the coolant system ("Restoring the coolant system", page 94).

# 11 Decommissioning

1. Switch the device off ("Shutting the device down and switching it off", page 143).
2. Remove the device from the power supply (carry out steps in reverse order as described in: "Connecting the device to the power supply", page 53).
3. Ensure that no water is inside the device.
4. Detach all cables and tubes.
5. Clean the device ("Cleaning and Maintenance Work for the User", page 154).
6. Attach the transport safety equipment (carry out the steps in reverse order as described in: "Removing the transport protection", page 46).
7. Pack the device in suitable packaging (e.g. original packaging).

## 11.1 Storing the device

1. Ensure that the storage space meets the following requirements:
  - dry
  - vibration free
2. Ensure that the storage requirements are met ("Ambient conditions for storage and transportation", page 179).

## 11.2 Disposing of the device



The operator is responsible for proper disposal. The product must not be disposed of in the household waste. It must be collected separately from the household waste and disposed of according to local regulations for the disposal of electronic equipment in an environmentally safe manner or returned to Ivoclar Vivadent for disposal.

---



---

# 12 Repair



---

**DANGER! Improper repairs/device maintenance.**

Danger to the user and to the patient.

- ▶ Repairs on the device must only be carried out by service partners authorized by Ivoclar Vivadent using the valid version of the Service Manual.
- 

## 12.1 Authorized service partners



---

For information about the authorized service partners in your country, contact your local distribution partner or Ivoclar Vivadent or go to: <http://www.ivoclarvivadent.com>.

---

## 12.2 Sending defective devices for repair



---

Use only the original packaging together with the corresponding foam material for transportation purposes.

---

1. Take the device out of service before returning it to the authorized service partner ("Decommissioning", page 176).
2. Send the device in suitable packaging (e.g. original packaging) to the service partner.

# 13 Technical Data



The following technical data refer exclusively to the PrograMill PM7 milling machine.

For information on the technical data of the accessories or other components of the PrograMill PM5 milling system, please refer to the respective operating instructions ("Supporting documents", page 9).

---

## 13.1 Classifications

Characteristics	Value
Test standards	<ul style="list-style-type: none"> <li>• EN 61010-1 :2010</li> <li>• UL 61010-1 :2012</li> <li>• CAN/CSA-C22.2 No. 61010-1 :2012</li> <li>• IEC 61010-1 :2010</li> </ul>
Radio protection / Electromagnetic compatibility	EMV certified
Noise level	<p>Milling the measuring disc according to the following measuring specifications:</p> <ul style="list-style-type: none"> <li>• Suction on</li> <li>• Water pump not activated</li> <li>• Lights switched on</li> <li>• Measurement according to ISO 61010-1</li> <li>• Measuring distance to sound source: Usual distance for user / working position of the user</li> </ul> <p>This results in the following values when milling the materials:</p> <ul style="list-style-type: none"> <li>• PMMA: 81 dB(A)</li> <li>• Zirconium oxide: 69 dB(A)</li> <li>• IPS e.max CAD glass-ceramic: 71 dB(A)</li> </ul>

## 13.2 Measurements, weight

Characteristics	Value
Height x width x depth	818 mm x 979 mm x 695 mm
Weight	Approx. 210 kg

## 13.3 Ambient conditions

### 13.3.1 Ambient conditions for storage and transportation

Characteristics	Value
Acceptable ambient temperature	-20 °C to +65 °C
Maximum relative humidity	80%
Acceptable ambient pressure	500 mbar to 1060 mbar

### 13.3.2 Ambient conditions for operation

Property	Value
Acceptable ambient temperature	+15 °C to +30 °C
Maximum relative humidity	70% for temperatures up to 30 °C, gradually decreasing to 50% relative humidity at 40 °C; condensation excluded.
Maximum operating altitude	2000 m above sea level / elevation

## 13.4 Electrical data

Characteristics	Value
Network connection	100 to 240 V / 50 to 60 Hz
Permissible voltage fluctuations	± 10%
Max. input	3 A
Values of electrical fuses	T 10 A; 250 V; high breaking capacity: 1000 A
Dimensions of electrical fuses	5 x 20 mm
Max. power input	300 W

### 13.5 Compressed air consumption and requirements on incoming compressed air

Characteristics	Value
Compressed air consumption	205 l/min
Pressure	Min. 6.5 to 7 bar; max. 8 bar
Sealing air	Yes
Quality	Oil and water free according to ISO 8573-1
Solid matter particles	<ul style="list-style-type: none"><li>• Class 3</li><li>• Filter rate better than 5 µm for solid matters</li></ul>
Water	<ul style="list-style-type: none"><li>• Class 4</li><li>• Maximum pressure condensation point +3 °C</li></ul>
Maximum oil content	<ul style="list-style-type: none"><li>• Class 3</li><li>• Maximum oil content 1 mg/m<sup>3</sup></li></ul>

# 14 Appendix

## 14.1 Delivery form

Item description	Number	Item number
Milling Machine PrograMill PM5	1	689239**
PrograMill Disc holder for PM3/5/7	7	689242
IPS e.matrix for PM 3/5/7	1	689241
RFID Container for disc holder	1	689246
Patch Cable 5 m, green cat. 5	1	697435
RFID device (read/write module) TS-H34	1	697437
Used tool library for PM 3/5/7	1	697433
Webcam	1	697436
Sample Blank for PrograMill + Label	2	697510
PrograMill Tool Pliers PM3/5	1	706205
Torque Screwdriver 0.45 Nm	1	697430
Torque Screwdriver 2.8 Nm	1	697431
Hex Bit 3 mm	2	697432
PrograMill Tool green 2.5c for PM3/5	1	689047
PrograMill Tool green 1.0c for PM3/5	1	689048
PrograMill Tool green 0.5c for PM3/5	1	689049
Spindle Maintenance Set for PM3/5	1	689252
Tool Magazine for PM3/5	1	702053
Outside Micrometer for PrograMill	1	697681
Operating Instructions PrograMill PM5	1	country-specific

## 14.2 Ordering spare parts

- When ordering spare parts, keep the following information ready:
  - Item number
  - Serial number
- Contact your authorized service partner.

## 14.3 Recommended additional components

### 14.3.1 CAM software

Item description	Number	Item number
PrograMill CAM V4 (incl. licences for up to 4 PrograMill milling machines)	1	690257
Upgrade CAM V3 to PrograMill CAM V4 (existing licences maintain their validity)	1	690258

### 14.3.2 PrograMill Base set

Item description	Number	Item number
PrograMill Base set (incl. PrograMill Suction Unit and PrograMill Tank)	1	689970
PrograMill Base (without devices)	1	689971
PrograMill Base Inlay (spare)	1	689972
PrograMill Suction Unit	1	689973
PrograMill Prefilter for Suction Unit (spare)	1	689974
PrograMill Fine Filter for Suction Unit (spare)	1	689975
PrograMill Tank	1	689978
PrograMill Filter for Tank (spare)	1	689979
PrograMill Filter Cartridge for Tank (spare)	1	689980
Coolant Concentrate PrograMill Fluid (1 litre)	2	689981

### 14.3.3 Material holder

Item description	Number	Item number
PrograMill Disc holder for PM3/5/7	1	689242
Digital Denture Holder Ring for PM7	1	689245
IPS e.matrix for PM3/5/7	1	689241

## 14.4 Approved tools

**NOTICE! Use of not approved tools.**

Damage to the device.

- ▶ Only use the tools recommended in these instructions and by Ivoclar Vivadent.



The number in the article description corresponds to the shaft diameter in millimetres. Further identification of the tools:

- c = coated (coating for higher durability)
- g = grinder (diamond-coated grinder for wet processing of glass-ceramics)
- f = flat (flat cutter)

### 14.4.1 Suitable for zirconium oxide

Item description	Number	Item number
PrograMill Tool yellow 2.5c for PM3/5	1	689036
PrograMill Tool yellow 1.0c for PM3/5	1	689037
PrograMill Tool yellow 0.5c for PM3/5	1	689038
PrograMill Tool yellow 2.5 for PM3/5	1	689039
PrograMill Tool yellow 1.0 for PM3/5	1	689040
PrograMill Tool yellow 0.5 for PM3/5	1	689041

### 14.4.2 Suitable for glass-ceramic

Item description	Number	Item number
PrograMill Tool red g3.0 for PM3/5	1	689042
PrograMill Tool red g2.0 for PM3/5	1	689043
PrograMill Tool red g1.0 for PM3/5	1	689044
PrograMill Tool red g0.5 for PM3/5	1	689045

### 14.4.3 Suitable for PMMA / DCL

Item description	Number	Item number
PrograMill Tool green 2.5c for PM3/5	1	689047
PrograMill Tool green 1.0c for PM3/5	1	689048
PrograMill Tool green 0.5c for PM3/5	1	689049
PrograMill Tool green f1.5c for PM3/5	1	689046

### 14.4.4 Suitable for wax

Item description	Number	Item number
PrograMill Tool black 2.5 for PM3/5	1	689051
PrograMill Tool black 1.0 for PM3/5	1	689052
PrograMill Tool black 0.5 for PM3/5	1	689053
PrograMill Tool black f1.5c for PM3/5	1	689050

### 14.4.5 Suitable for cobalt chrome (CoCr) / titanium (Ti)

Item description	Number	Item number
PrograMill Tool blue 3.0c for PM3/5	1	692446
PrograMill Tool blue 2.0c for PM3/5	1	689054
PrograMill Tool blue 1.5c for PM3/5	1	689055
PrograMill Tool blue 1.0c for PM3/5	1	689056
PrograMill Tool blue 0.6c for PM3/5	1	689057









# Ivoclar Vivadent – worldwide

## **Ivoclar Vivadent AG**

Bendererstrasse 2  
9494 Schaan  
Liechtenstein  
Tel. +423 235 35 35  
Fax +423 235 33 60  
www.ivoclarvivadent.com

## **Ivoclar Vivadent Pty. Ltd.**

1 – 5 Overseas Drive  
P.O. Box 367  
Noble Park, Vic. 3174  
Australia  
Tel. +61 3 9795 9599  
Fax +61 3 9795 9645  
www.ivoclarvivadent.com.au

## **Ivoclar Vivadent GmbH**

Tech Gate Vienna  
Donau-City-Strasse 1  
1220 Wien  
Austria  
Tel. +43 1 263 191 10  
Fax: +43 1 263 191 111  
www.ivoclarvivadent.at

## **Ivoclar Vivadent Ltda.**

Alameda Caiapós, 723  
Centro Empresarial Tamoré  
CEP 06460-110 Barueri – SP  
Brazil  
Tel. +55 11 2424 7400  
Fax +55 11 3466 0840  
www.ivoclarvivadent.com.br

## **Ivoclar Vivadent Inc.**

1-6600 Dixie Road  
Mississauga, Ontario  
L5T 2Y2  
Canada  
Tel. +1 905 670 8499  
Fax +1 905 670 3102  
www.ivoclarvivadent.us

## **Ivoclar Vivadent Shanghai Trading Co., Ltd.**

2/F Building 1, 881 Wuding Road,  
Jing An District  
200040 Shanghai  
China  
Tel. +86 21 6032 1657  
Fax +86 21 6176 0968  
www.ivoclarvivadent.com

## **Ivoclar Vivadent Marketing Ltd.**

Calle 134 No. 7-B-83, Of. 520  
Bogotá  
Colombia  
Tel. +57 1 627 3399  
Fax +57 1 633 1663  
www.ivoclarvivadent.co

## **Ivoclar Vivadent SAS**

B.P. 118  
74410 Saint-Jorioz  
France  
Tel. +33 4 50 88 64 00  
Fax +33 4 50 68 91 52  
www.ivoclarvivadent.fr

## **Ivoclar Vivadent GmbH**

Dr. Adolf-Schneider-Str. 2  
73479 Ellwangen, Jagst  
Germany  
Tel. +49 7961 889 0  
Fax +49 7961 6326  
www.ivoclarvivadent.de

## **Ivoclar Vivadent Marketing (India) Pvt. Ltd.**

503/504 Raheja Plaza  
15 B Shah Industrial Estate  
Veera Desai Road, Andheri (West)  
Mumbai, 400 053  
India  
Tel. +91 22 2673 0302  
Fax +91 22 2673 0301  
www.ivoclarvivadent.in

## **Ivoclar Vivadent Marketing Ltd.**

The Icon  
Horizon Broadway BSD  
Block M5 No. 1  
Kecamatan Cisauk Kelurahan Sampora  
15345 Tangerang Selatan – Banten  
Indonesia  
Tel. +62 21 3003 2932  
Fax +62 21 3003 2934  
www.ivoclarvivadent.com

## **Ivoclar Vivadent s.r.l.**

Via del Lavoro 47  
40033 Casalecchio di Reno (BO)  
Italy  
Tel. +39 051 6113555  
Fax +39 051 6113565  
www.ivoclarvivadent.it

## **Ivoclar Vivadent K.K.**

1-28-24-4F Hongo  
Bunkyo-ku  
Tokyo 113-0033  
Japan  
Tel. +81 3 6903 3535  
Fax +81 3 5844 3657  
www.ivoclarvivadent.jp

## **Ivoclar Vivadent Ltd.**

4F TAMIYA Bldg.  
215 Baumoe-ro  
Seocho-gu  
Seoul, 06740  
Republic of Korea  
Phone: +82 (2) 536-0714  
Fax: +82 (2) 6499-0744  
www.ivoclarvivadent.co.kr

## **Ivoclar Vivadent S.A. de C.V.**

Calzada de Tlalpan 564,  
Col Moderna, Del Benito Juárez  
03810 México, D.F.  
México  
Tel. +52 (55) 50 62 10 00  
Fax +52 (55) 50 62 10 29  
www.ivoclarvivadent.com.mx

## **Ivoclar Vivadent BV**

De Fruittuinen 32  
2132 NZ Hoofddorp  
Netherlands  
Tel. +31 23 529 3791  
Fax +31 23 555 4504  
www.ivoclarvivadent.com

## **Ivoclar Vivadent Ltd.**

12 Omega St, Rosedale  
PO Box 303011 North Harbour  
Auckland 0751  
New Zealand  
Tel. +64 9 914 9999  
Fax +64 9 914 9990  
www.ivoclarvivadent.co.nz

## **Ivoclar Vivadent Polska Sp. z o.o.**

ul. Jana Pawla II 78  
00-175 Warszawa  
Poland  
Tel. +48 22 635 5496  
Fax +48 22 635 5469  
www.ivoclarvivadent.pl

## **Ivoclar Vivadent LLC**

Prospekt Andropova 18 korp. 6/  
office 10-06  
115432 Moscow  
Russia  
Tel. +7 499 418 0300  
Fax +7 499 418 0310  
www.ivoclarvivadent.ru

## **Ivoclar Vivadent Marketing Ltd.**

Qlaya Main St.  
Siricon Building No.14, 2<sup>nd</sup> Floor  
Office No. 204  
P.O. Box 300146  
Riyadh 11372  
Saudi Arabia  
Tel. +966 11 293 8345  
Fax +966 11 293 8344  
www.ivoclarvivadent.com

## **Ivoclar Vivadent S.L.U.**

Carretera de Fuencarral nº24  
Portal 1 – Planta Baja  
28108-Alcobendas (Madrid)  
Spain  
Tel. +34 91 375 78 20  
Fax +34 91 375 78 38  
www.ivoclarvivadent.es

## **Ivoclar Vivadent AB**

Dalvägen 14  
169 56 Solna  
Sweden  
Tel. +46 8 514 939 30  
Fax +46 8 514 939 40  
www.ivoclarvivadent.se

## **Ivoclar Vivadent Liaison Office**

: Tesvikiye Mahallesi  
Sakayik Sokak  
Nisantas' Plaza No:38/2  
Kat:5 Daire:24  
34021 Sisli – Istanbul  
Turkey  
Tel. +90 212 343 0802  
Fax +90 212 343 0842  
www.ivoclarvivadent.com

## **Ivoclar Vivadent Limited**

Compass Building  
Feldspar Close  
Warrens Business Park  
Enderby  
Leicester LE19 4SD  
United Kingdom  
Tel. +44 116 284 7880  
Fax +44 116 284 7881  
www.ivoclarvivadent.co.uk

## **Ivoclar Vivadent, Inc.**

175 Pineview Drive  
Amherst, N.Y. 14228  
USA  
Tel. +1 800 533 6825  
Fax +1 716 691 2285  
www.ivoclarvivadent.us

Translation of the original operating instructions

Version: 1

Date of issue: 2019-03

For software V4.0 and higher

This device has been developed solely for use in dentistry. Setup and operation should be carried out strictly according to the Operating Instructions. Liability cannot be accepted for damages resulting from misuse or failure to observe the Instructions. The user is solely responsible for testing the apparatus for its suitability for any purpose not explicitly stated in the Instructions.