



Blue Carbon
蓝晶易碳



48V/350Ah

17.92kWh
BCT-UU 48-350
(With MPPT)

Name: Solar Power System
Model: BCT-UU 48-350(M)

BCT

BCT-UU 48-350(With MPPT)



Application Places

For no city power areas, the battery pack can be charged by solar panels and used for night lighting; For the areas that city power is expensive, the battery pack can be charged during the electricity valley value period, and used at the peak power period; For the areas which power off from time to time, the battery pack can be used as UPS, to avoid information loss caused by sudden power outage. The battery pack is applicable to commercial lighting, industrial lighting, home lighting, outdoor lighting, camping tourism, farming, planting, the night market stalls, etc.

Blue Carbon, no need electricity bill at all.



Blue Carbon
蓝晶易碳

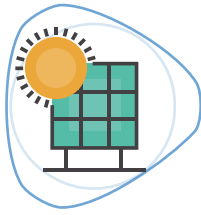

Clean energy

Using sunlight to achieve clean energy charging can supply power to household appliances.



Storing energy

Realize the freedom of electricity consumption in the area where there is no electricity and less electricity.



Household appliances

Free electricity

Storing the power from the solar panel, to be used as reserve power or emergency power supply. At night or at the time of power outage, it can supply the power to electrical appliances by using the stored energy, to avoid the inconvenience caused by power outage, so that you can calmly deal with the situation of power outages.

BCT

INSTRUCTIONS

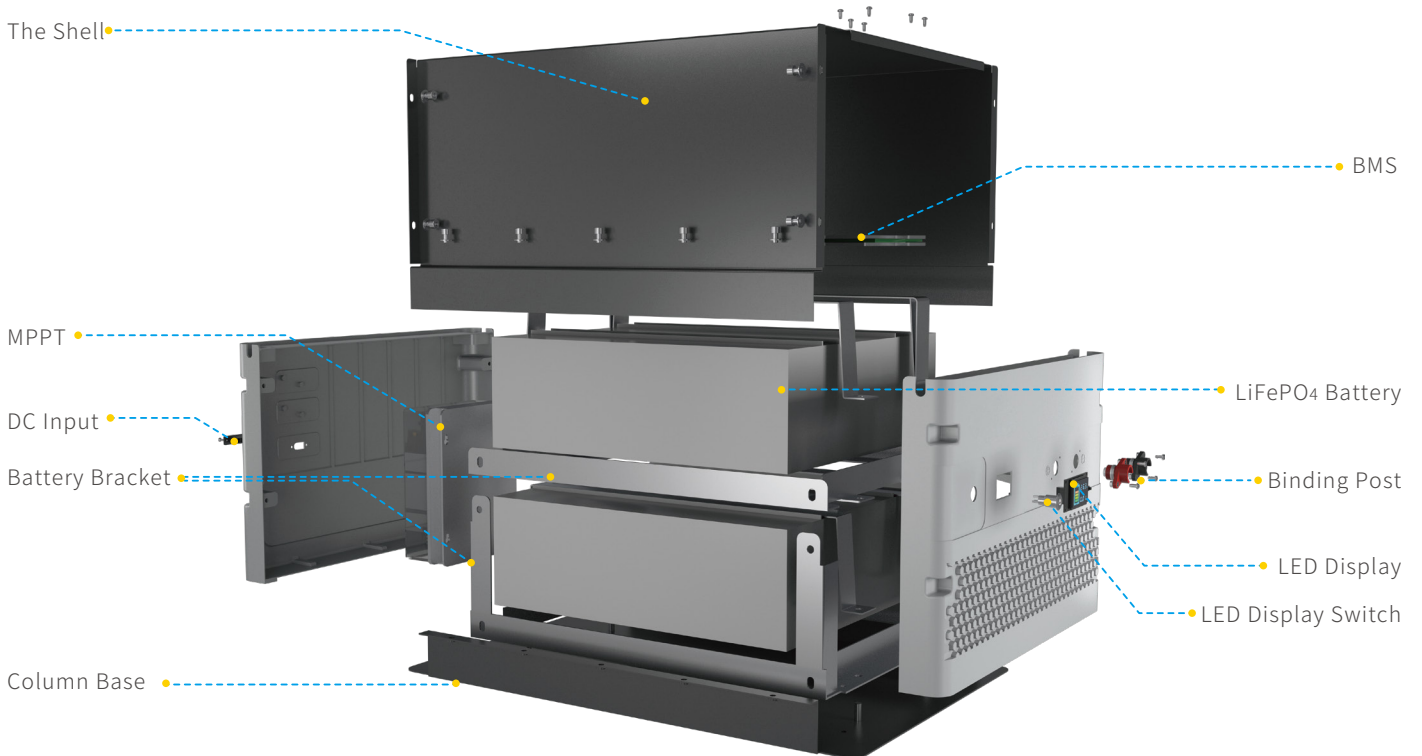

MPPT

- Integrated Charging-storage Energy System, reducing wiring, installation, etc. It is convenient for users to operate, and greatly reducing the space occupancy rate.
- Wide-voltage input, greatly improve the degree of freedom of solar panel in series or parallel connection. When unexpectedly high voltage is input, it can effectively block the high voltage, so that the battery's BMS will not be broken down, and greatly reduce the risk of the lithium battery's thermal runaway burning.
- Effectively track the maximum power point of the solar panel and increase the daily power generation of the solar panel by more than 30%.



17920Wh



DC output



Solar Panel Charging



Multiple Appliances

Blue Carbon, no need electricity bill at all.



Blue Carbon
蓝晶易碳

6 KINDS OF SAFETY PROTECTION



Charging Overvoltage Protection



Discharge Undervoltage Protection

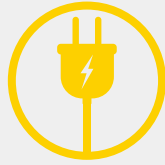

Charging Overcurrent Protection



Discharge Overcurrent Protection



Short Circuit Protection

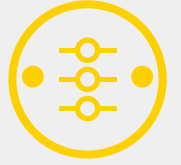

Temperature Protection

Product Details

LiFePO4 battery

Stable discharge, long cycle life, safe and environmental protection, high safety performance.

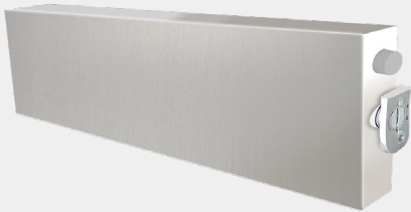

XT90 Gold plated plugs

Gold-plated brass, ensure the stable transmission of current.



BMS

Protect the battery, Prevent battery damage, Extend battery life.

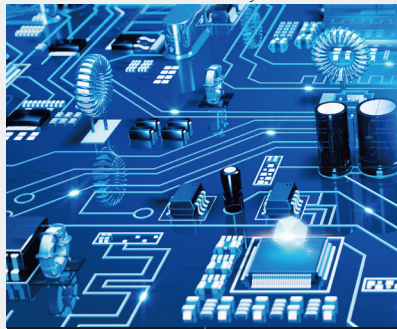

Imported components



Comply with UL standard safety certification



Separate driver modules



Use insulation materials

LED display

Observe the power usage at any time.



Function Introduction

Battery Remaining Capacity Real time battery voltage

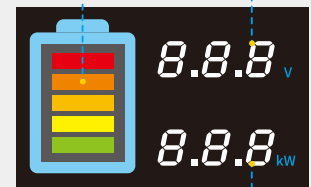

Real time output



Main switch

Stainless steel push button switch, Protect the upgrade.

Binding post

Insulated flame retardant, fast and efficient.



High quality aluminium magnesium alloy

Anti-corrosion, substantial, durable, artistic, practical.

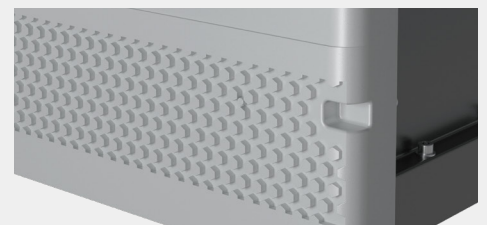

Blue Carbon, no need electricity bill at all.



Blue Carbon
蓝晶易碳

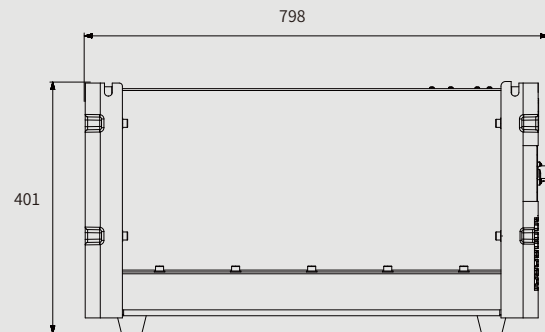
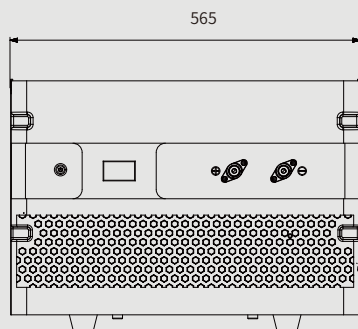
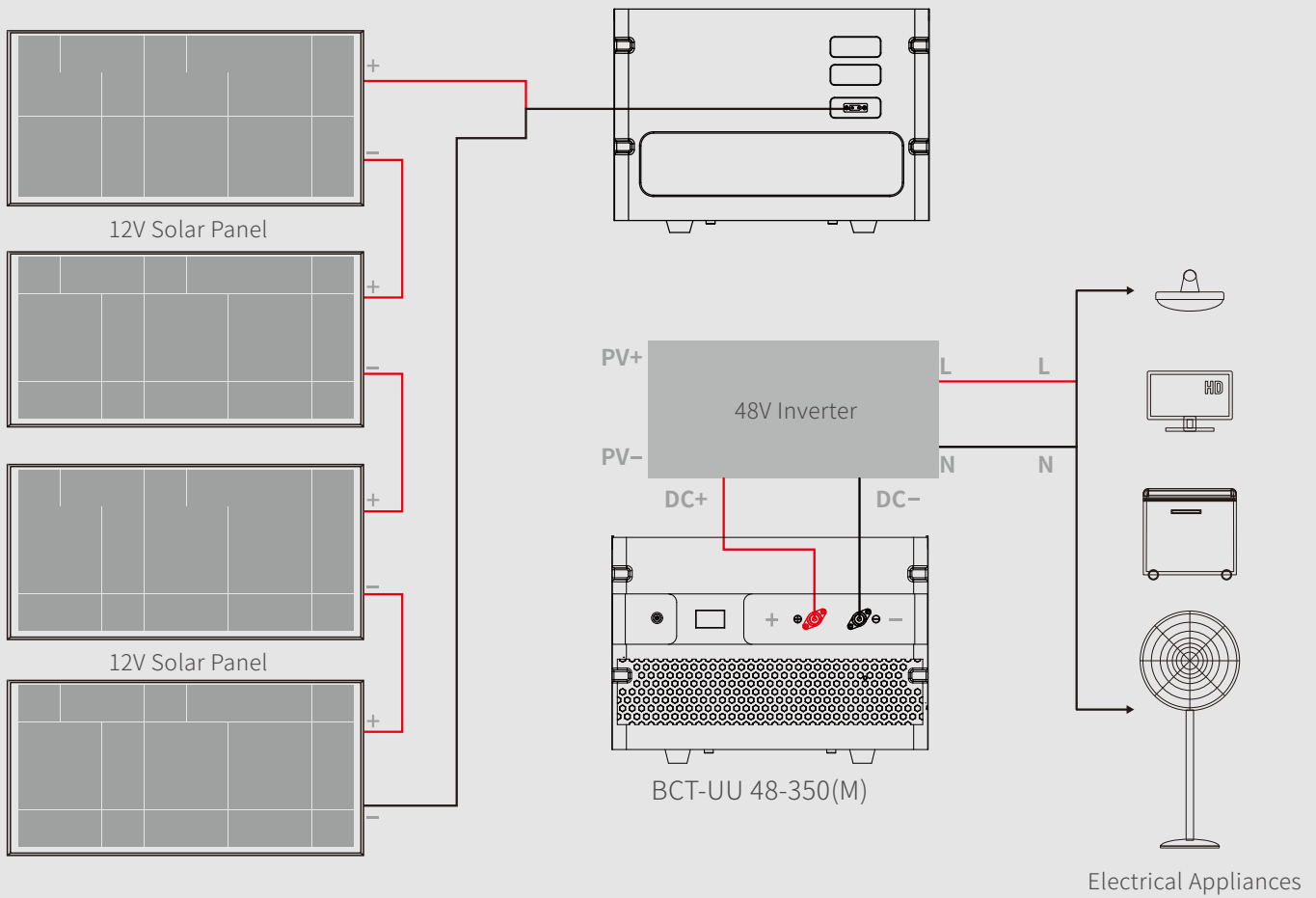

Product size: (mm)

Advantages

- High quality aluminium magnesium alloy, anti-corrosion, substantial, durable, artistic, practical.
- All in one mould design and production, easy to install.
- With longer span life LiFePO₄ battery, over 12 years lifespan, ensure the whole set products' life span.
- Dustproof structure design, DC output, safe and reliable.
- Integrated packaging, safe and convenient to transport.

Tel: +86-06332190373 Fax: +86-0633-2165720

Email: sales@bluecarbontech.com



Technical Parameters

Model	BCT-UU 48-350 (M)	
Basic Specifications	Nominal Capacity	350Ah
	Nominal Voltage	48V(51.2V)
	Electricity(kWh)	17.92kWh
MPPT	Electric Current	60A
	Maximum charging voltage	150V
Input	Full charge Voltage	56V-60V
	Input Voltage Range	30V-150V
	Maximum Solar Panel Input Current	80A
	Rshoot delay protection	1000ms
Output	Continuously Use Output Current	100A
	Discharge Cut-off Voltage	38V-48V
	Over-Discharge Delay Protection	1000ms
	Short Circuit Protection Delay	300us
	Short Circuit Protection Recovery	Disconnect Load
	Instant Start Current	300A
	Instant Start Current Time	10S

Battery	Cell Type	LiFePO4 Battery/LFP
	Storage Temperature Range	Short-Term -20°C-40°C(Within 1 month)
		Long-term 10°C-35°C(Within 1 year)
	Operating Temperature Range	-15°C-60°C
	Recommended Temperature Range	10°C-40°C
	Storage Humidity	≤75% RH
	Atmospheric Pressure	Below 5000 above sea level
	Self-Discharge (25°)	<3%/Month
	Depth of Discharge	>80%
	C-rate Discharge	<0.8C
Cycle Life	> 6000 Times (< 0.5c)	

Other	Certification Standards	UN38.3/CE/MSDS/DGM
	Warranty	5 years
	Product Size	798±2×565±2×401±2mm
	Packing Size	903±2×671±2×451±2mm

BCT

Instructions

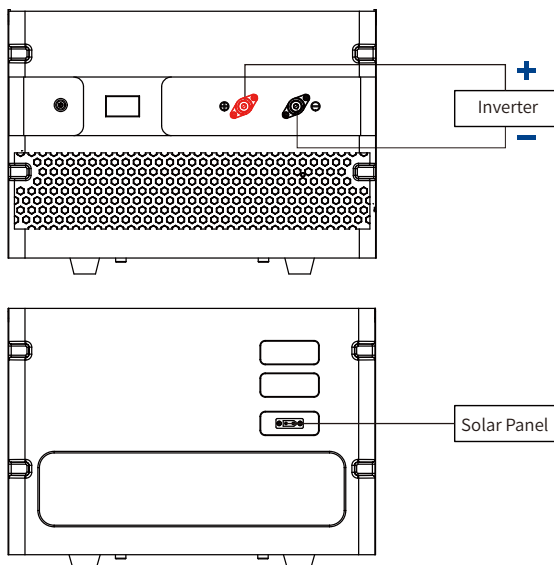

Attention:

1. It is forbidden to use any high-voltage to charge it. The open circuit voltage of 12V battery pack can not exceed 22V, 24V battery pack can not exceed 44V and 48V battery pack can not exceed 88V. The maximum open circuit voltage of solar panel can not exceed twice of the voltage of battery.
2. Please use a MPPT controller with lithium iron phosphate battery mode.
3. When the source voltage of the charging terminal is higher than 88V, in order to prevent the failure of the voltage conversion device in the middle and cause overcharging of the battery. The high-voltage circuit breaker with charging protection function must be connected between the charging controller and the battery.
4. 12V battery pack, maximum support 4 battery packs in series, the highest charging voltage of 4 battery packs in series is less than 88V, and the highest charging voltage of 2 battery packs in series is less than 44V. 24V battery pack, maximum support 2 battery packs in series, the highest charging voltage of 2 battery packs in series is less than 88V. 48V battery pack, it is forbidden to use in series. Ensure the batteries are discharged to empty condition or fully charged before connecting them in parallel.
5. It is forbidden to connect the positive and negative poles reversely and short circuit the positive and negative poles of the battery pack; The overload is strictly prohibited.
6. The battery pack should not be used in severe vibration scenarios.
7. It is strictly prohibited to put in water and clean the battery pack, and do not place the product in the outdoor exposed place for a long time to prevent rain or moisture.
8. It is forbidden to use or place the battery at high temperature. If battery is used for a long time, the recommended optimal ambient temperature is 10-40°C.
9. The battery should not be placed in the room where any combustible gas or flammable items are stored, and should be used in a clean, dry and ventilated environment.
10. It is strictly prohibited to knock, throw, reverse or trample on the battery pack. It is strictly prohibited to use the battery pack when the appearance is seriously damaged (artificial knocking, scraping, falling from height, unauthorized disassembly of the products, etc.).
11. It is strictly forbidden to dump or invert the product.

Please strictly following the above operating rules when using the battery pack.



BCT

Battery Specification

Different Rate Discharge Curve (25°C)

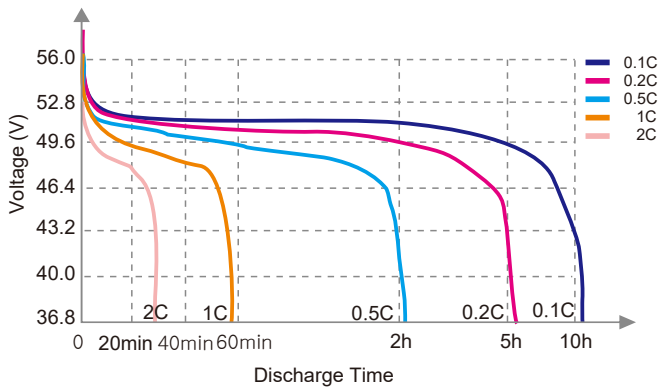

Different Temperature Discharge Curve (0.5C)

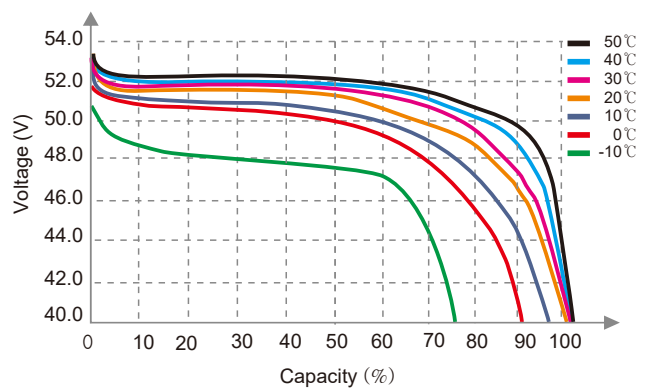

State of Charge Curve (0.5C, 25°C)

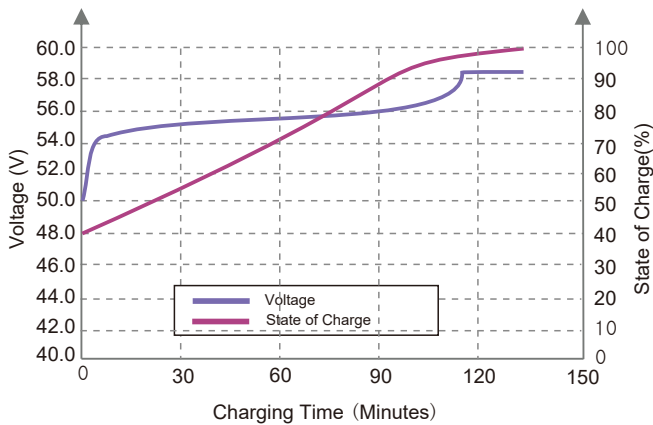

Charging Characteristics (0.5C, 25°C)

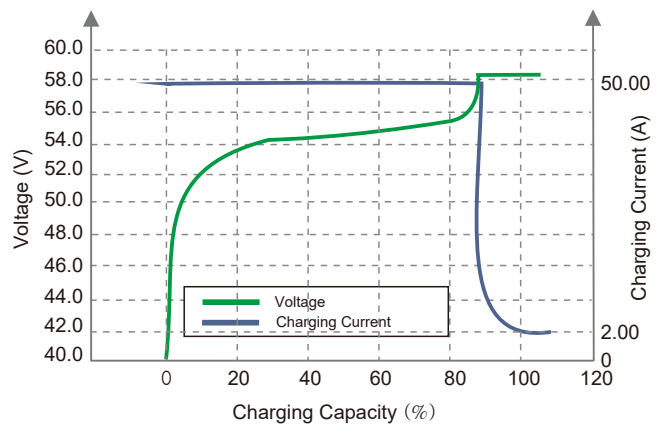

Different DOD Discharge Cycle Life Curve(1C)

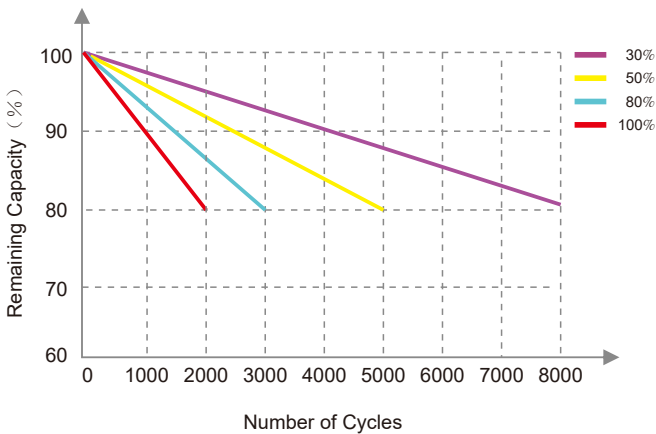

Different Temperature Self Discharge Curve

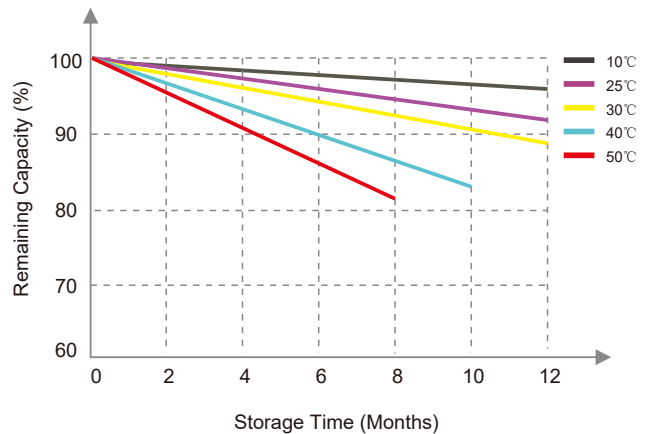



The Advantages and Characteristics of LiFePO₄ Battery

- **Volume:** The capacity of LiFePO₄ battery is bigger than lead-acid cell, with the same volume, it is double of Lead-acid battery.
- **Weight:** LiFePO₄ is light. The weight is just 1/3 of lead-acid cell with the same capacity.
- **Discharge rate:** LiFePO₄ battery can discharge with maximum current, it is used in electric vehicles and electric bicycles.
- **No memory effect:** No matter the LiFePO₄ Battery is in which conditions, it can be charged and discharged whenever you like, no need to discharge totally then charge for it.
- **Durability:** The durability of LiFePO₄ Battery is powerful and consumption is slow. The time of charging and discharging is more than 2000times. After 2000times circulation, the capacity of the battery is still more than 80%.
- **Security:** LiFePO₄ battery passed the strict safety testing, with higher safety performance.
- **Environmental protection:** Lithium materials not have any poisonous and harmful substance. It is regarded as green and environmental protection battery. The battery has no any pollution no matter in the process of production or in the process of using.
- **Well graded and combination.** After multi-selection, to ensure each cell qualified with long life;
- **The connection tech of all interface, be safe and durable, with simple maintenance.**
- **Multi-layer protection structure, shockproof, anti explosion and fire.**
- **Safe and durable for long run.**
- **Security and reliability, compared with lead-acid battery, the materials of LiFe PO₄ is the securest, the best choice of solar energy storage battery.**

Storage and Transportation

- Based on the character of cell, proper environment for transportation of LiFePO₄ battery pack need to be created to protect the battery.
- Battery should be kept in warehouse where it's dry, clean and well-ventilated.
- During loading of battery, attention must be paid against dropping, turning over and serious stacking.



Notices

- Never use or keep the battery under the high temperature. Otherwise it will cause battery heat, get into fire or lose some function and reduce the life.
- Never throw the battery into fire or heating machine to avoid fire, explosion and environment pollution; scrap battery should be returned to the supplier and handled by the recycle station.
- Never use the battery under strong static and strong magnetic field, otherwise it will destroy the protecting device.
- If battery leaked, the electrolyte get into eyes, please don't knead, please wash eyes by water and send to hospital. Otherwise it will hurt eyes.
- If battery emit peculiar smell, heating, distortion or appear any unconventionality during using, storage or charging process, please take it out from device or charge and stop using.
- Never cut the battery in socket directly; please use the stated charger when charging.
- Check the voltage of battery and relevant connectors before using the battery. It can't be used until everything turns out to be normal.
- Prior to charging, fully check the insulativity, physical condition and ageing status, since breakage and ageing are never allowed.
- The battery should be stored in half SOC. It needs to be charged once if out of use for as long as half a year.
- Clean the dirty electrode, if any, with a clean dry cloth, or poor contact or operation failure may occur.

Warning

- Never knock, throw or trample the battery.
- Never upside down the positive and negative.
- Never connect the positive and negative of battery with metal.
- Never ship or store the battery together with metal.
- Never cut through the battery with nail or other edge tool.
- Never throw the battery into water, please keep it under dry, shady and cool circumstance when not use.



Blue Carbon
蓝晶易碳

BCT

Usage Scenarios





Blue Carbon
蓝晶易碳

BCT

Usage Scenarios

