

# Li-ion battery User Manual

Version : V1.0









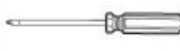

***All Right Reserved ©SHENZHEN NEATA POWER TECH CO.,LTD***

Without prior written permission of Neata, any corporations or individual shall not copy the contents of this document in part or in whole, and shall not spread it in any form.

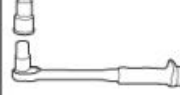
V1.0 Date: 2021-01-10

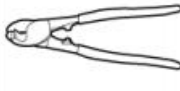
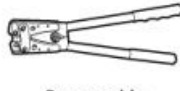
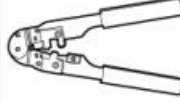
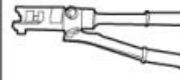
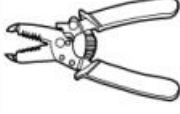
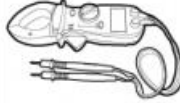
## Before Start

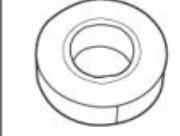
### 1. What you need?

 Utility knife	 Phillips screwdriver	 Flat-head screwdriver	 Adjustable torque wrench	 Socket wrench
 Diagonal pliers	 Power cable cutter	 Power cable crimping tool	 RJ45 crimping tool	 Hydraulic pliers
 Wire stripper	 Clamp meter	 Heat gun	 Heat shrink tubing	 PVC insulation tape
 Steel measuring tape	 Protective gloves			

### 2. Safety Precautions

- Wear goggles, rubber gloves, and protective clothing before installing or maintaining battery modules, to avoid skin contact with electrolyte overflow,
- Keep battery circuit disconnected during installation and maintenance.
- Tightening the cables by the recommended torque. Loose connections will result in excessive voltage drops, which may cause The Li-ion battery to heat up and burn out when the current is high.
- Avoid your skin and eyes from the battery electrolyte leakage if it happens . Wash with clean water immediately and visit a doctor if the situation is serious when your body touches electrolyte leakage.
- Do not swallow any part of the BMS or any substance contained in battery.
- Protect battery from mechanical vibration, collision, punctures, and strong impact. Otherwise it may catch fire.
- Do not throw battery in fire, because this may cause battery to ignite.
- Do not put battery in water or expose them in the rain.
- Replacing a battery with an incorrect model may cause cross current and bias current, which will trigger battery protection. Long-time operation with an incorrect model will result in cell or board faults, which may cause risks such as fire.

- If battery loop is short-circuited, The battery protection will be triggered and battery cannot be charged or discharged. Long-time frequent short circuiting can result in cell or board faults, which may cause risks such as fire.
- The battery communication failure alarm caused by reasons such as loose communications cable connection should be handled within 72 hours (default value, configurable in the range of 1 minute to 720 hours). Otherwise, The battery will be internally locked, which may affect battery power backup.
- Dispose of waste battery in strict accordance with local laws and regulations.

### 3. Appearance and Ports

#### a. Appearance



#### b. Ports

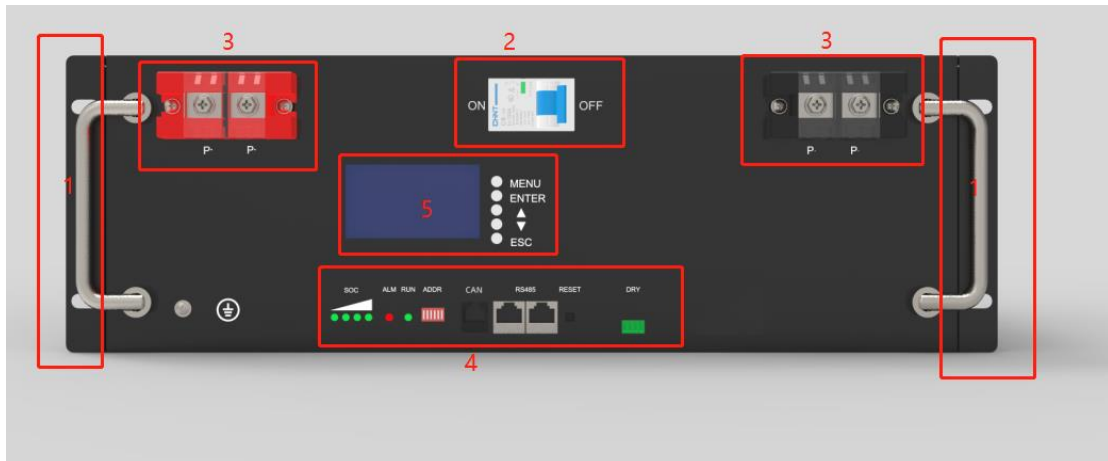

#### c. Definition

No.	Silk Screen	Item	Description
1		19inch cabinet installation	check with your Cabinet supplier
2	<b>on/off</b>	Breaker -manual power on/off	The breaker can activate the energy storage of lithium battery.
3	<b>+</b>	Positive terminal	Connect the Positive and negative ports use the

3	-	Negative terminal	cable which offered by our side, the recommended cable size is 25 mm2
4	<b>SOC</b>	Battery capacity remain indicator The four SOC indicators are steady on-Green	1. Capacity 0–24% 2. Capacity 25%–49% 3. Capacity 50%–74% 4. Capacity 75%–99%
	<b>RUN</b>	Run indicator	Green-running well.
	<b>ALM</b>	Alarm indicator	Red- a fault or major alarm. Off: no fault or major alarm. Blinking and off: rest and start BMS
	<b>ID</b>	DIP address,	Follow up our manual for parallel application, asking our sales team for this documents
	<b>CAN/RS485</b>	Connect battery to inverter for communication	Used to connected with inverter
	<b>BAT LINK (RS485)</b>	Battery between battery communication	Connect this port to next battery for parallel application check battery status by BMS upper software via this port,
5	<b>LCD</b>	Press and enter manual	Used to view battery details from cell to whole battery pack

These port will be little changed ,but same functions, we will offer BMS user manual if need more details.

Suggest for engineer checking these BMS functions , not allowed to change by personal without approval.

ALM description:

Important alarm: the fault light is on and other indicators are all off, requiring timely maintenance.

Minor alarm: the fault indicator is off, and other indicators are all off.

Refer to "Normal Description". No maintenance is required, remind the remote maintenance personnel to pay attention.

Normal description:

Standby: run indicator, on for 0.125s and off for 1.5s.

Charging: the highest indicator of run+soc, on for 3s and off for 1s;

Discharge: run indicator, on for 0.15s and off for 0.15s.

Sleep mode: all indicators are always off

## 4. Installation

- Be cautious to avoid injury when moving heavy objects.
- When moving the equipment by hand, wear protective gloves to prevent injuries

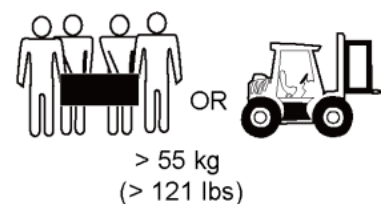
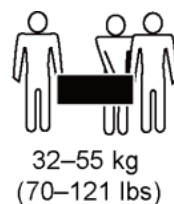
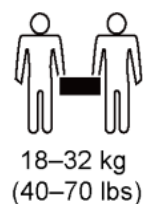

NH01H00144



High voltage generated by the equipment during operation may cause an electric shock, which could result in death, serious injury, or serious property damage. Prior to maintenance, power off the equipment and strictly comply with the safety precautions in this document and relevant documents.

- Maintain the equipment with sufficient knowledge of this document and using proper tools and testing equipment.
- Before maintaining the equipment, power it off and follow the instructions on the delayed discharge label to ensure that the equipment is powered off.
- Place temporary warning signs or erect fences to prevent unauthorized access to the maintenance site.
- If the equipment is faulty, contact your dealer.
- The equipment can be powered on only after all faults are rectified. Failing to do so may escalate faults or damage the equipment.
- Do not open the cover without authorization. Otherwise, electric shocks may occur, and the resulting faults are beyond warranty scope.
- Installation personnel, maintenance personnel, and technical support personnel must be trained to operate and maintain the equipment safely and correctly, take comprehensive precautionary measures, and be equipped with protective instruments.
- Before moving or reconnecting the equipment, disconnect the mains and batteries and wait for five minutes until the equipment powers off. Before maintaining the equipment, check that no dangerous voltages remain in the DC bus or components to be maintained by using a multimeter.
- Battery maintenance should be carried out or supervised by personnel who are familiar with batteries and the precautions required.
- When replacing batteries, replace them with batteries or battery strings of the same type.
- Take out all tools and parts from the equipment after maintenance is complete.
- If the equipment is not used for a long time, store and recharge batteries according to this document.

#### A. Operation procedure

Step No.	Name	Definition
1	Turn off power supply	System should be powered off, to ensure no electric during installation
2	Mechanical installation	1. Mounting lugs installation 2. Battery fixed installation
3	Electrical installation	1. Grounding cable 2. Power cable installation 3. Connecting equipment installation 4. Communication cable installation
4	Electrical commissioning	Power system commissioning

##### ● Step 1. Turn off Power Supply

Before installation, please ensure the battery is powered off, at the same time, shutdown the equipment which need to connect to the battery.



## ● Step 2 Mechanical installation

### 1. Mounting lugs installation.

Equipment packaging with the chassis mounting lugs, before the installation of equipment, fix the mounting lugs on both sides of the battery box, ensure that the installation strong.

### 2. Battery installation.

Battery module preference mounted in the rack 19 inch ( or cabinet ), when installed, portable handle arranged in parallel on the frame ( or cabinet ) supporting plate, push rack ( or cabinet ), ensure the mounting lugs and frame ( or cabinet ) edge fixing hole tightly, and then using a screwdriver with screw for fixation screwed into the rack to the mounting holes, to ensure that the battery pack mounted solid.

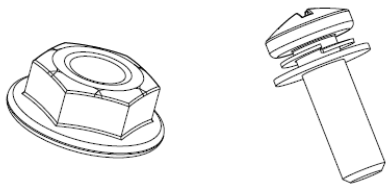

M6 explosive screw X4, M6 flange nut X4

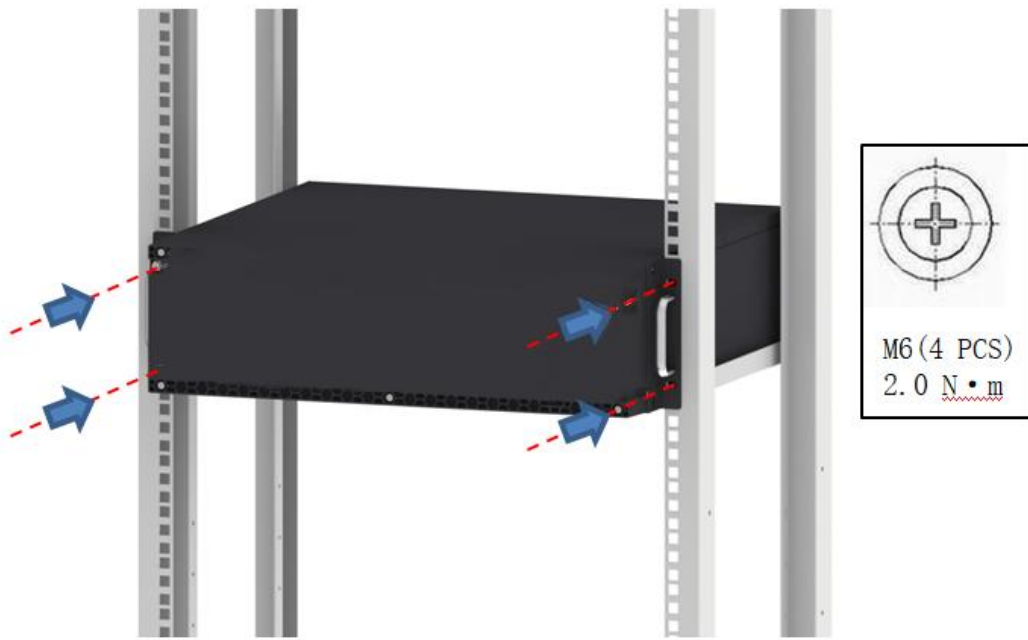

● Step 3 Electrical installation

3.1 Grounding cable:

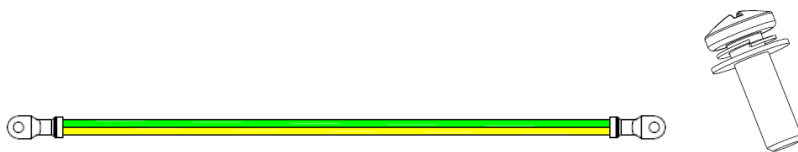

M4 screw X2, Grounding cable x1

The grounding cable end with screw press-fit fixation in the chassis rear grounding hole, the other end is connected to the frame ( or cabinet ) grounding copper bar to ensure the stable connection.

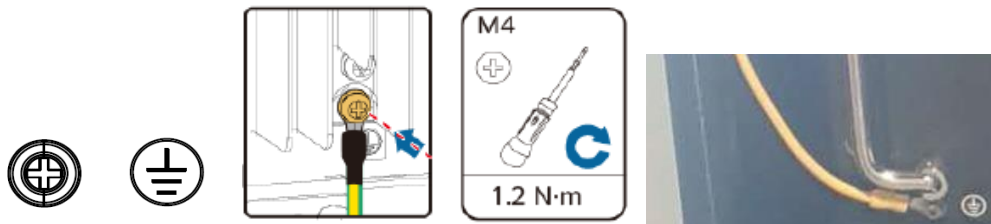

**INTRO**

It is recommended that silica gel or paint be used around the ground terminal after the PE cable is connected.

3.2 Power cable installation





When using a single battery, battery terminals directly connected to the device or switch power supply terminal, if there are multiple batteries in parallel when in use, please connect all batteries to the copper bus-bar with the power cable in cabinet or rack.

**Fit an OT terminal to the power cable**

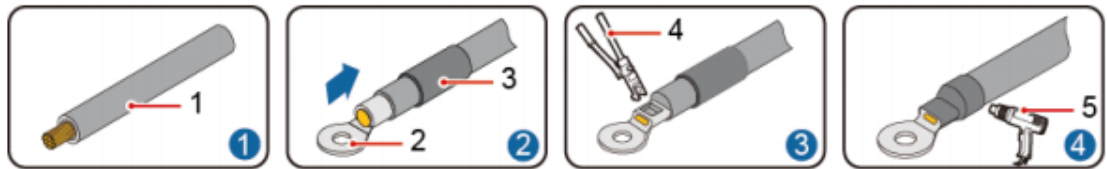

HD00ZC1002

(1) Cable

(2) OT terminal

(3) Heat shrink tubing

(4) Hydraulic pliers

(5) Heat gun

**⚠ CAUTION**

- When installing the power cable, ensure that the protruding part of the OT terminal on the cable must be facing outward.
- Do not connect two or more cables to the positive and negative power ports in inverter or batteries.

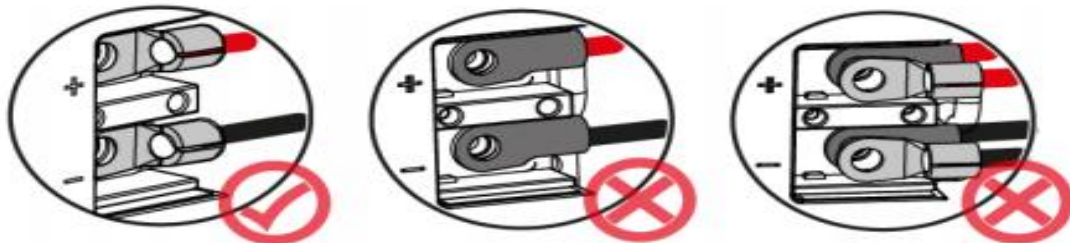

**Cabinet connection application**

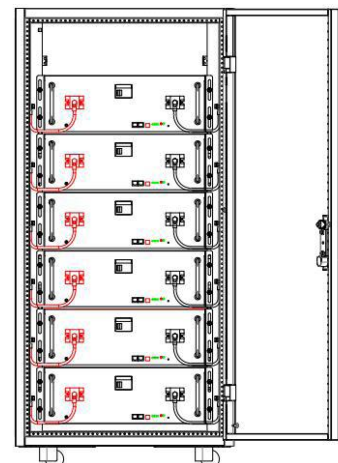
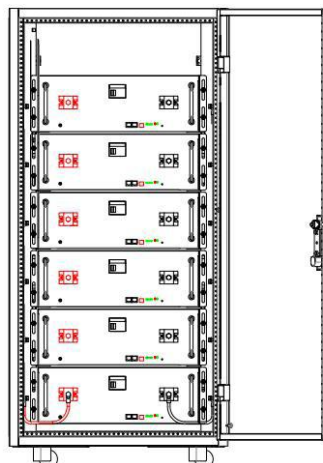
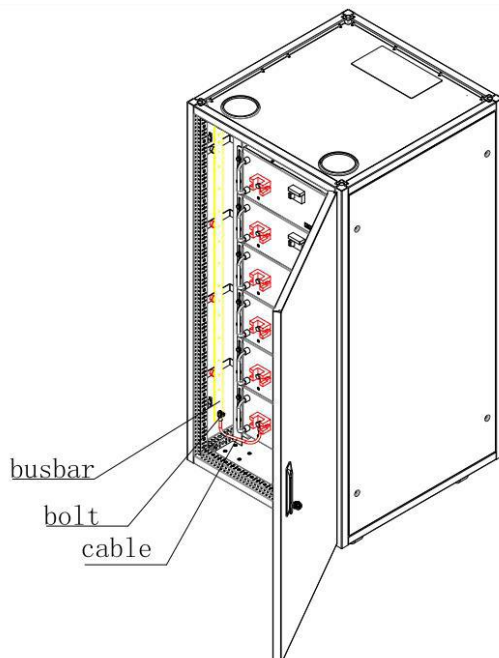



Inverter application connections :

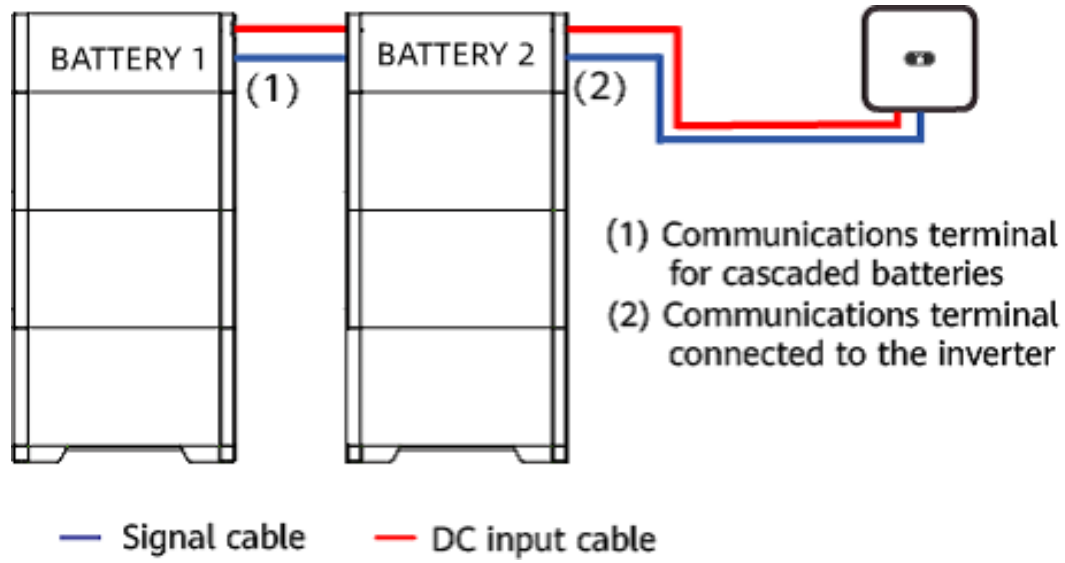

### 3.3 Connecting equipment installation

Connect the copper bus-bar to charger/load system with power cable, Be careful not to connect the positive and negative poles correctly.

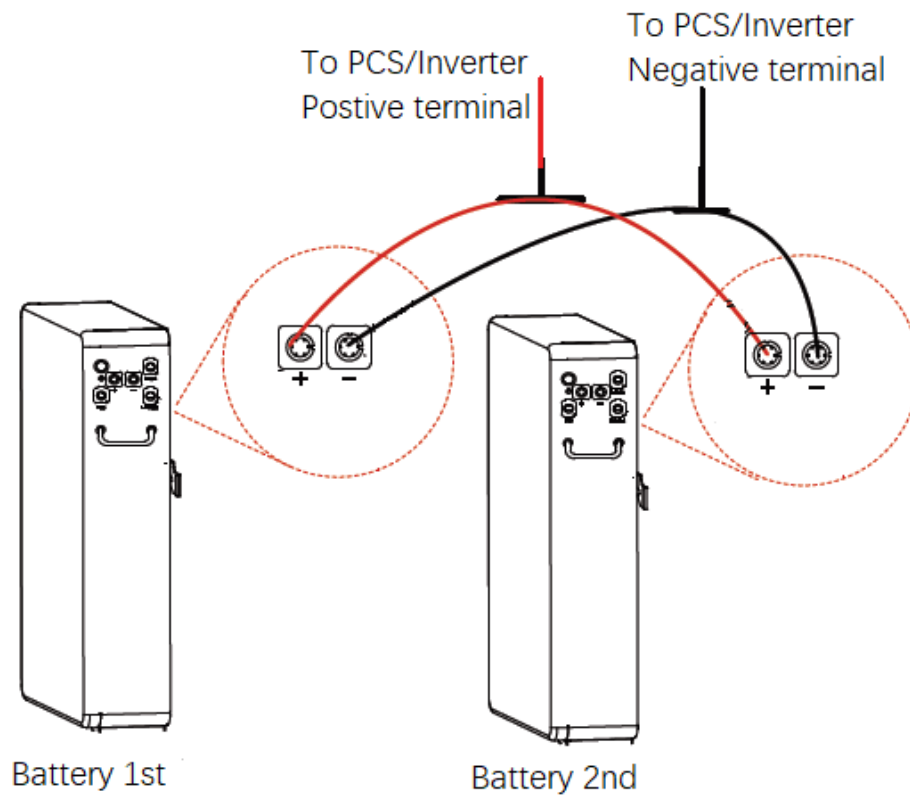

### 3.4 Communication cable installation

When the battery is used in a single, please skip this step.

When a plurality of batteries used in parallel , please dial settings for each cell address code ( to ensure that no duplicate address code ), and then connect the communication interface of RJ45-RS485 one by one.

Connect the first or last battery module CAN/RS485 interface to the PC monitor or SMPS or UPS controller.

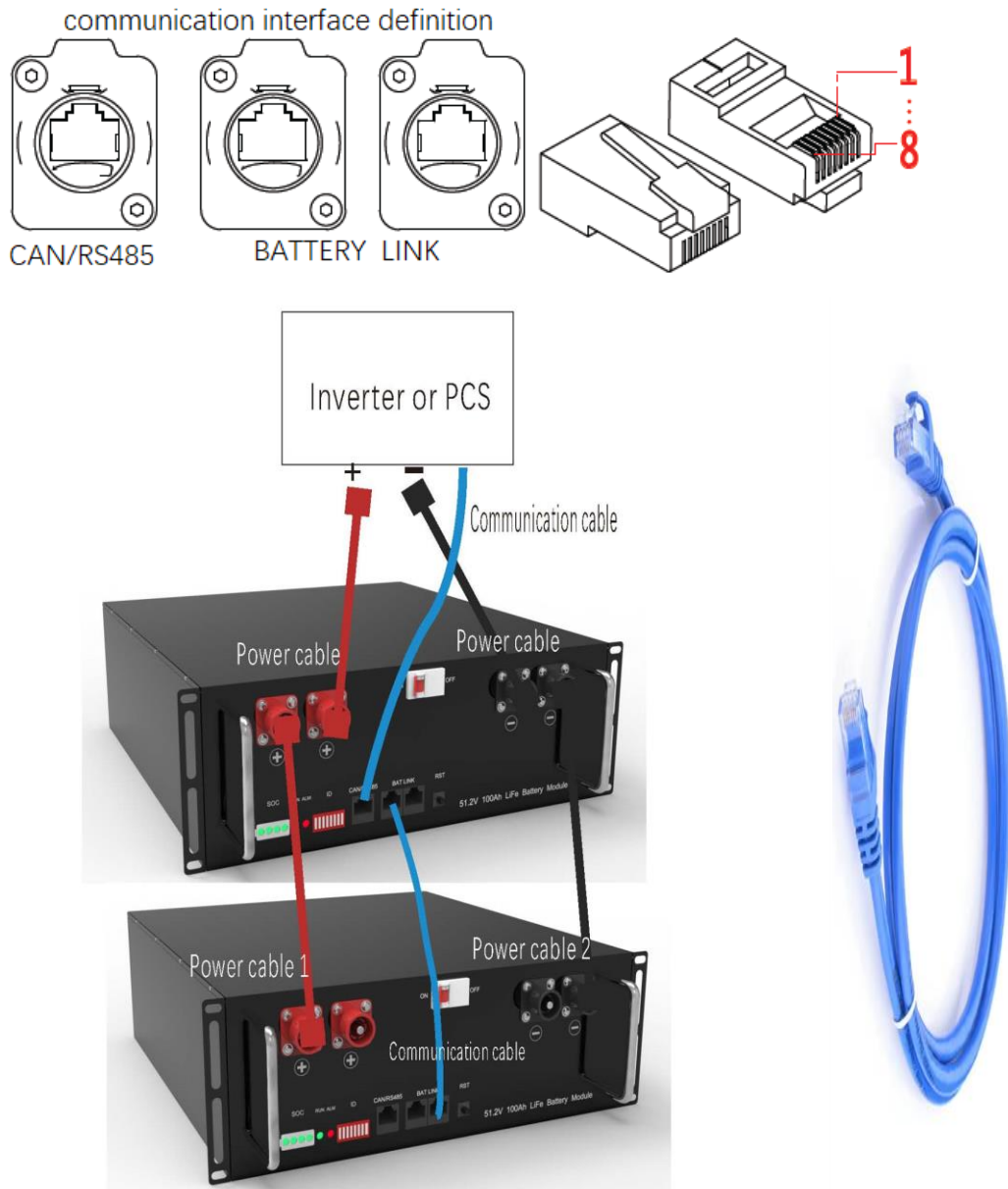

#### ● Step 4. Electrical commissioning

When these steps are completed, turn on air switch to start the battery one by one, then boot on the whole power system, complete the installation.



- If you have any question about the installation, please stop and contact technical support immediately.
- If the battery does not start or control panel ALM lights, please disconnect the power line inspection and re-install the start, if still cannot solve please contact technical support, avoid damage to equipment or cause accidents.

#### ■ Parallel Connection Mode

The lithium battery can be connected in parallel to increase the backup time or backup power. The backup power of a single battery is 5 kW.

At our technology could support Max 50pcs in parallel, but we suggest use 15pcs in parallel.

Qty. of parallel	2	3	4	5	6	7	.....	50
Maximum Power	10	15	20	24	24	24	.....	24

#### ■ Acceptance Conditions

No.	Item	Acceptance standard
1	Indicator status	The indicator status is normal (the RUN indicator is steady on and no indicator is red).
2	Working status	To check if the Smart works properly ( by simulating a mains outage or mains recovery).
3	Current	To check if Li-ion battery current is normal. The current deviation is within $\pm 2$ A, according to system settings.

## 5. Activation and Startup

When the equipment is powered on for the first time, ensure that professional personnel set parameters correctly. Incorrect settings may result in inconsistency with local certification and affect the normal operation of the equipment.



- The main power ON/OFF button is a breaker. Please use this breaker major.
- If the battery is power off in charging, discharging, or disconnected mode by pressing the REST button, the battery can be reactivated by pressing and holding this button.

For sleeping mode lithium battery (BMS cut off)

There are three ways to activate battery. After activation, the lithium battery wakes up from sleep mode:

- Activation through the MANUAL ON/OFF button:

Turn on the MANUAL ON/OFF breaker.

- Activation through the REST Point:

Use a sharp pieces to press REST on the panel for at least 5s.

- Activation through the power port:

Supply a DC voltage of 48–58V to the power terminal on the front panel for at least 5s.

## Power on

Power on the PACK by breaker		
No	Procedures	Acceptation criteria
1	Connect the battery and PCS/inverter	Make sure the wiring harnesses are well connected
2	Close the breaker of the PACK	Make sure the breaker is ON
3	Turn on breaker for three to eight seconds. Observe the LED indication on panel.	1. If both RUN/ALM and SOC lights turn on normally, PACK is powered on successfully. 2. If RUN/ALM light turns red, there is a failure and should solve it before power on again.
Power on the PACK by PCS or inverter		
1	Connect the battery and PCS	Make sure the wiring harnesses are well connected
2	Close the breaker of the PACK	Make sure the breaker is ON
3	Power on the PCS. PCS outputs a wake up signal of 5V or an output main circuit voltage signal of 46-58V	1. If both RUN/ALM and SOC lights turn on normal, PACK powers on successfully. 2. If RUN/ALM light turns red, there is a failure and should solve it before power on again.

## Power off

- Press the power breaker to turn off the PACK and five LED lights will flicker for three times.
- If under the situation of multiple packs in parallel, only turning off one of the packs then the whole battery system will turn off

# 6. Maintenance Guide

## Preparation

- Tools like safety gloves, cross head driver and socket wrench should be prepared.
  - Turn off and turn on new PACK.
1. If the PACK is power-off. Press power button for 3-8 seconds to turn on.
  2. If the PACK is power-on. Press power button once to turn off.

Before maintaining the battery, turn off the breaker and press power button once to make sure the PACK is in the power-off mode. Follow the installation and wire connection procedures specified above.

Ensure wires are properly connected before turn the breaker on. After that, turn on the breaker and press power button of any PACK for 3-8 seconds to check if the system normal works.

## Pack Replacement

- Wear safety gloves.
- Close the breaker and power off the PACK.
- Disconnect power lines and CAN communication lines of the PACK.
- Wall-mounting PACK: Uninstall the safety screws on both sides of the PACK. Lift up the PACK.
- Floor-standing PACK: Uninstall the safety part and open the connector at both ends of the battery of the batteries. Lift up the PACK.
- Put the PACK into the packing box according to the repair procedure and transport the PACK to the designated repair site.
- Install new PACK based on procedure specified in Section 4.

## System Failure Information List and Troubleshooting Suggestions

Error Indication	Error description	Error root	Suggested actions
ALM			
ALM Light Flickers	Discharge under Voltage protection	Single cell voltage below the threshold for under-voltage Protection.	There is over discharge risk. User should stop discharging and arrange recharge
	Charge over voltage protection	Single cell voltage exceeding threshold for protection threshold.	1. There is no safety threat; 2. User should stop charging. Idle PACK and it will turn to normal status.
	External CAN Communication failure	Communication loss between PCS/inverter and PACK.	1. There is no safety threat and user should stop using battery. 2. Check if PCS/inverter and battery communication terminal is well connected. 3. If PCS/inverter and PACK cannot communicate when the communication wire is confirmed well connected, user should contact installer to repair battery
	Interior RS485 Communication failure	Communication loss Between two parallel	1. Check RS485 connection Between two batteries, RS485 connection between Linkin and Linkout;
	Parallel connection Failure protection	Communication failure between two parallel connected PACK	1. Check Rs485 connection between two batteries, CAN connection between Battery and PCS/inverter.
ALM Light on	Discharge short circuit	External short circuit of PACK	There is safety risk and user should stop using battery User should contact installer to repair PCS/inverter and battery
	Precharger short circuit		
	Precharger overtime circuit		
	Type inconsistency of PACK	The pack type is different	There is safety risk and user should stop using battery User should contact installer to use the same PACK in Parallel.
	Main circuit fault	BMS main power circuit failure	There is safety risk and user should stop using battery. User should contact installer to repair battery

## 7. Transportation and Storage

### ● Transportation Requirements

The product passes the certification of the UN38.3 (UN38.3: Section 38.3 of the sixth Revised Edition of the Recommendations on the Transport of Dangerous Goods, Manual of Tests and Criteria) and SN/T 0370.2-2009 (Part 2: Performance Test of the Rules for the Inspection of Packaging for Exporting Dangerous Goods). This product belongs to class 9 dangerous goods.

The product can be delivered to the site directly and transported by land and water. The packing case must be secured for transportation, compliant with related national standards, and printed with marks such as anti-collision and moisture prevention. Dispose of waste The Smart series lithium battery must be in strict accordance with local laws and regulations

Protect the packing case with the product from the following situations:

- Being dampened by rains, snows, or falling into water
- Falling or mechanical impact
- Being upside-down or tilted

### ● Storage Requirements

Storage Safety

1. Place :The lithium battery according to the signs on the packing case during storage. Do not put them upside down or sidelong.
2. Stack The lithium battery packing cases by complying with the stacking requirements on the external package.
3. The storage environment requirements are as follows:
  - Ambient temperature: 0–40°C; recommended storage temperature: 20 – 30°C
  - Relative humidity: ≤ 95%, dry, clean, proper ventilation
  - Keep away from corrosive and organic substances (including gas)
  - In a place free from direct sunlight
  - At least 2 meters away from heat sources (such as a heater)
4. The warehouse keeper should collect The storage information every month and periodically report the inventory information to the planning department. The battery that have been stored overdue should be recharged in time.
5. Regional office or organizations should not store The lithium battery or main equipment lithium battery. Prior approval should be obtained for any requirements on battery storage.
6. The lithium battery should be delivered based on the “first-in, first-out” rule.
7. Keep away from sources of strong infrared radiation, organic solvents, and corrosive gases, and keep far away from sources of fire.

● **Overdue Storage**

It is recommended that lithium battery not be stored for a long period. It should be used in time onsite.

Table Storage requirements

Required Storage Temperature	Actual Storage Temperature	Recharge interval	Remarks
0°C~40°C	0°C ≤ T ≤ 30°C	12 to 10 months	Not reaching the time for recharge: Use the battery as soon as possible.
	30°C ≤ T ≤ 34°C	8to 6 months	Reaching the time for recharge: Recharge the battery The total storage duration should not exceed the warranty period

 **INTRO**

1. If lithium battery have been stored overdue, promptly report the event to the department leader.
2. Dispose of bulging lithium battery directly irrespective of how long they have been stored.
3. The storage duration (t) starts from the latest charge time on lithium battery package. The latest charge time is updated after every charge.
4. If a lithium battery is qualified after charge, mark the latest charge time and the next recharge time on the assigned position. The next recharge time is 8 months (stored above 30°C) or 12 months (stored below 30°C) later than the latest charge time. The total storage duration should not exceed the warranty period.

■ **Process Mode Before Recharge**

- Check battery appearance.
- Dispose of bulging battery directly.
- Dispose of damaged or misshapen battery directly.
- Dispose of leaking battery directly.
- Clean battery terminals using sandpaper if they are corroded.

■ **Recharge Solution**

Recharge battery that pass tests using either of the following solutions based on site requirements.

Using a power system for recharging:

1. Identify qualified battery that can be recharged.
2. Install lithium battery and connect cables by referring to the quick installation guide of the related power system.
3. Use the power system to recharge battery.
4. Turn on the breaker wait all indicators on the front panel turn off and then remove the cables.

Place the lithium battery in the original packing case. Modify the latest charge time and the next recharge time marked on the original packing case.

User can recharge lithium battery with a purchased or borrowed DC regulated power supply that supports 48V charge by the following operation:

- Connect respectively the positive and negative poles of a lithium battery to the output positive and negative terminals on a DC regulated power supply.

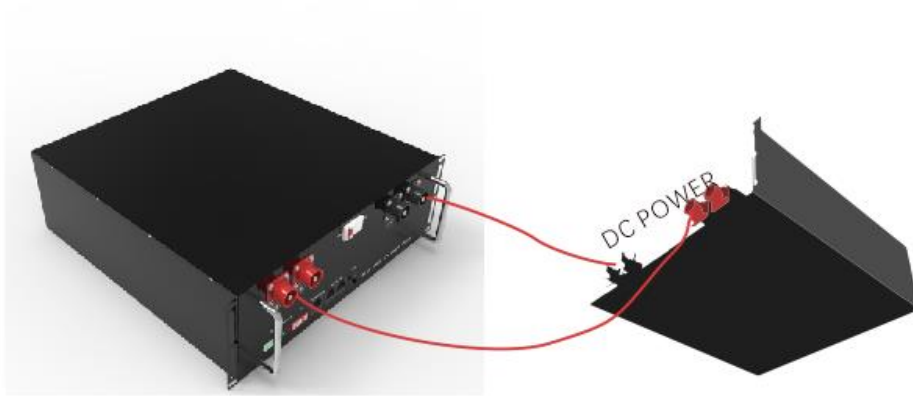

- Set charge parameters of the DC regulated power supply equipment. For details, see table below

Recharge Parameter	Setting Value
Charge voltage	48V100-15: 53.5V 51.2V100-16: 56.4V
Charge current	The maximum charge current is 100A.
Cut-off condition	The charge duration is more than 10min and the charge current is less than 0.02C or battery protected.

- Turn off breaker on the front panel for at least 5s and less than 15s. Wait all indicators on the front panel turn off and then remove the cables.

Place lithium battery in the original packing case. Modify the latest charge time and the next recharge time marked on the original packing case.



- Batteries can be activated through power cables.
- Do not operate with power on when connecting the recharge cables.

#### ※ Qualification Standards for Recharge

Required Recharge End Voltage	Required Voltage After Open-Circuit for 8 Hours
≥51	≥48

1. For the qualified lithium battery after recharge, turn off breaker on the front panel. Wait all indicators on the front panel turn off and then remove the cables. Place battery in the original packing case. Mark the latest charge time and the next recharge time (the default interval time for next recharge time is 12 months). The packed lithium battery should be used as soon as possible.
2. If battery is not qualified after recharge, recharge it again. If still not qualified, dispose of it.

**End**