

AJ-B 20

STANDARD PROPERTIES

Preheater
 Batteries and cables
 Electronic battery charger
 Fuel tank integrated in the chassis
 Flexible fuel hoses and oil drain valve
 Electrostatic powder painted chassis made of steel sheet welded
 Stainless galvanized steel cabinet design

OUTPUT VALUES

Standby Power			Prime Power		
kVA	kW	Ampere	kVA	kW	Ampere
20	16	29	18	15	26

DIESEL ENGINE

ISO 8528, ISO 3046, BS 5514, DIN 6271 state-of-the-art engine brands with low fuel consumption, fuel pump mounted, mechanical or electronic type governor are used.

Brand	Baudouin
Model	4M06G20/5
Max Total Output Power (kWm/hp)	20/27
Cylinder Volume (lt)	2,3
Cylinder Arrangement	4 Single Lines
Bore x Stroke (mm*mm)	89*92
Governor Type	Electronic
Cycle (Rotation)	1500 RPM
Intake System	Natural
Spray Type	Directly
Cooling Type	Water Cooled
Electric System (VCD)	12
Oil Capacity (lt)	9,5
Cooling Water Capacity (lt)	12,9
Fuel Consumption %50 (lt/h)	2,6
Fuel Consumption %75 (lt/h)	3,7
Fuel Consumption %100 (lt/h)	4,8

ALTERNATOR

4-pole self-excited brushless, synchronous alternator, maintenance-free bearing system, providing precise voltage adjustment with electronic type voltage regulator.

Output Voltage (V)	230/400
Frequency (Hz)	50
Permanent Voltage Reg. (\pm) (%)	0,01
Short Circuit Current	% 300 (10 sec)
Insulation Class	H
Protection Class	IP23
Efficiency(%)	88
Working Time at Overload	% 110 for 1 hour
Power Factor (cos Phi)	0,8
Total Harmonic Distortion Rate	% 1 less than
Connection Style	Phillips (Star)
Pole Number	4
Number of Beds	Single
Cabin Type	AJE-01

Altas Generator reserves the right to make changes in the technical specifications and cabin dimensions in advance due to the ongoing developments in generator technology without prior notice..

DIMENSIONS AND WEIGHT

CABINET GROUP	Width (mm)	1000	CABINLESS GROUP	Width (mm)	1000
	Size (mm)	1850		Size (mm)	1500
	Height (mm)	1300		Height (mm)	1200
	Weight (Kg)	950		Weight (Kg)	750
	Fuel Tank Capacity (Lt)	125		Fuel Tank Capacity (Lt)	125

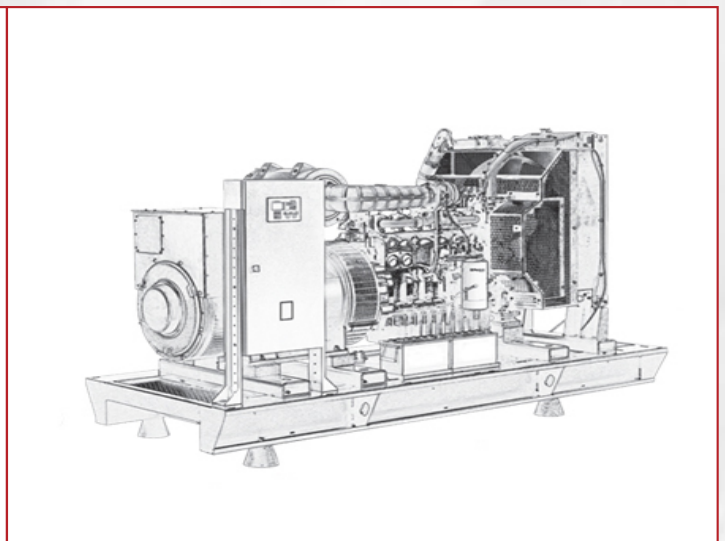
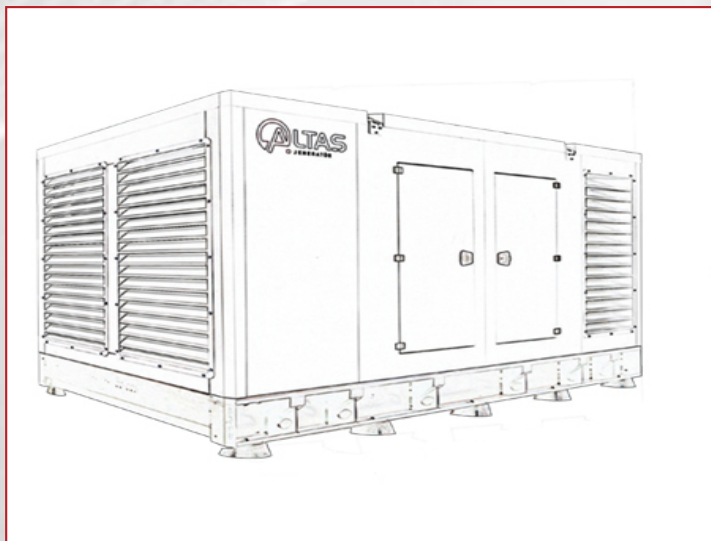

OPTIONAL FEATURES

- Sound insulation cabin
- Transfer board
- Fuel water separator filter
- Alternator output switch
- Fuel tank heater
- Oil heater
- External fuel tank and transfer pump
- Remote monitoring and control
- Synchronization systems
- Special type exhaust silencer
- Trailer

CONTROL PANEL FEATURES



- Diesel and gas generator support
- 400 Hz generator support
- Event record with 400x measurement value
- All parameters can be changed from the front panel
- 3 level program password
- 128x64 pixel graphic LCD
- Language upload
- Current-voltage waveform
- Current-voltage harmonic analysis
- 16 Amp / 250V ŞK / JK outputs
- 8 programmed digital inputs
- 6 programmed digital outputs
- 3 programmed analog inputs
- CANBUS-J1939 & MPU input
- 3 scheduled service alarms
- Multiple automatic test program
- 609 / 5000 Çeviri sonuçları Weekly work schedule
- Dual generator support, equal aging
- Fine speed adjustment (some ECUs)
- Automatic fuel pump control
- Protection cancellation feature
- Overpower protection
- Reverse power protection
- Overcurrent IDMT protection
- Load shedding, dummy load
- Multiple load shedding programs
- Current unbalance protection
- Voltage unbalance protection
- Fuel filling and theft alarms
- Battery backed real time clock
- Idle speed control
- Battery charging operation
- Battle mode support
- Multiple nominal condition definitions
- Contactor and motorized switch drive
- 4 quarter energy meters
- Network energy meters
- Fuel fill counter
- Fuel consumption counter
- Modem dignostik page
- Via USB, RS-232 and GPRS parameter setting
- Free configuration software
- SMS control facility
- Ready to watch the center
- Mobile generator support
- Automatic GSM geolocation
- GPS connection (RS232)
- Installing software via USB
- IP65 protection (with gasket)