

1200W Portable Power Station

Ideal portable emergency power for outdoor camping and home use

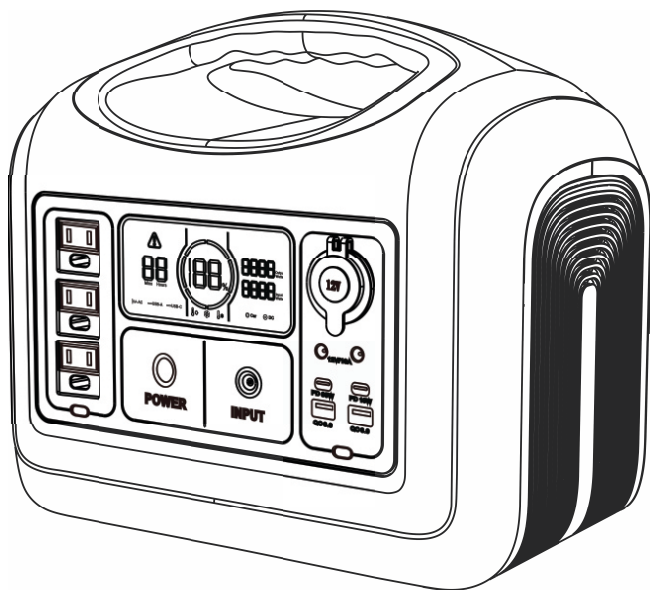

100~120V/220~240V

User Manual

Content

1. Disclaimer	1
2. Product List	1
3. Function Instructions	2-5
3.1 Function Description	2-4
3.2 LCD Screen Description	5
4. Direction of Use	5-11
4.1 Three Different Recharge ways	6-8
4.1.1. Standard AC Adapter	6-7
4.1.2. Car Charger	7
4.1.3. Solar Panel Charger	8
4.2 Discharge Output Instructions	9-10
Main Power Switch Instructions	9
4.2.1 AC Output Instructions	10
4.2.2 DC Output Instructions	10

4.3 LED Light Instructions	-----	10-11
5. Appliances Run Time Instructions	-----	12
6. Frequency switching operation	-----	13
7. Storage & Maintenance	-----	14
8. Main Technical Specification	-----	15-16
9. Fault Code and Trouble Shooting	-----	17

1. Disclaimer

1. The Company is not responsible for any damage caused by force majeure (e.g. fire, typhoon, flood, earthquake or customer's negligence, abuse or use in other unusual circumstances).
- 2.The Company is not responsible for the loss caused by the use of non-standard connectors.
- 3.The Company is not responsible for any damage caused by the wrong operation which didn't follow the instructions of user manual.

2. Products List

No.	Items	Qty.
1	Portable Power Station	1
2	AC Adapter	1
3	7909 connected wire for Vehicle's 12V Output	1
4	User Manual	1
5	Warranty Card	1

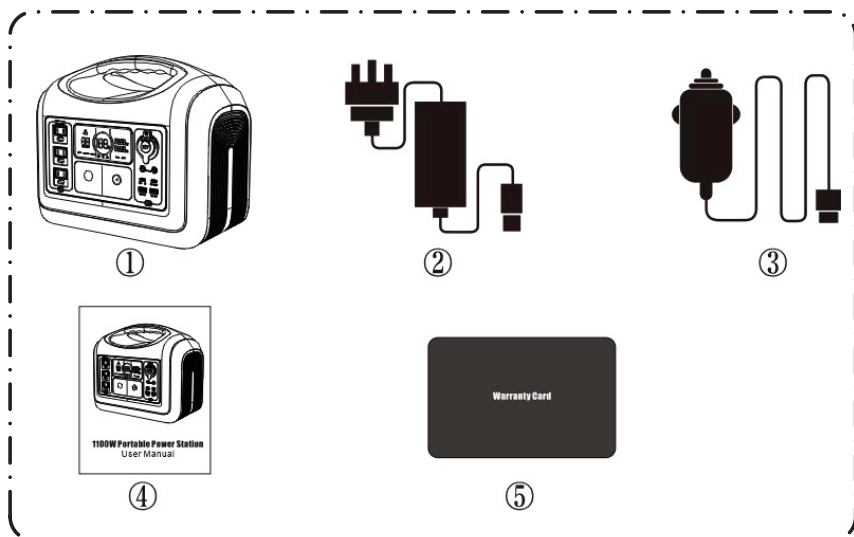

3. Function Instructions

3.1 Function Description

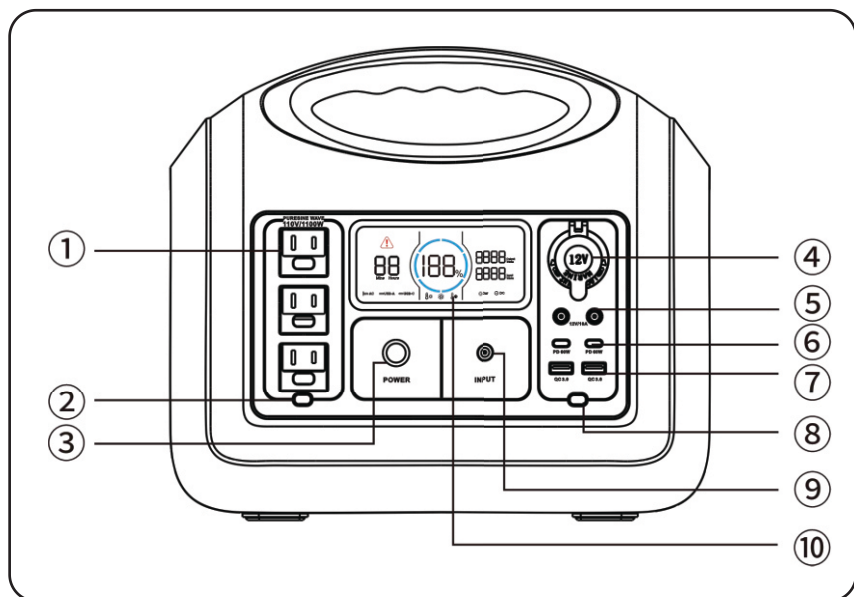

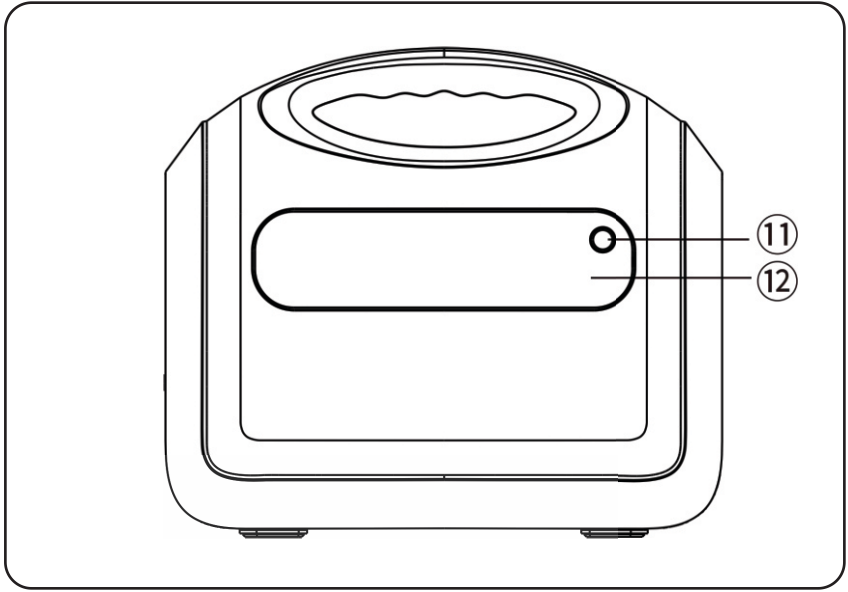

1.AC Output Port

2.AC Output Power On/Off Switch

3.Main Power On/Off Switch

4.12V Car Charger Output Port

5.12V DC5521 Output Port

6.USB-C Output Port*2

7.USB-A Output Port*2

8.DC Output Power On/Off Switch

9.7909 Recharging Input Port

10.LCD Screen

11.LED Light Power On/Off Switch

12. LED Light

3.2 LCD Screen Description

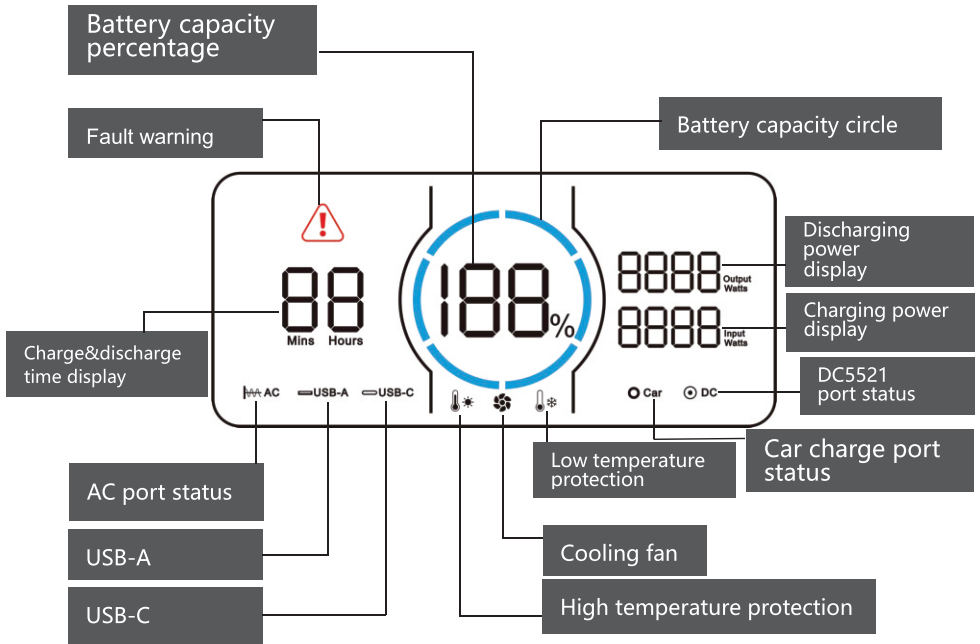

4. Direction of Use

The LCD Battery Capacity Ring indicates the left capacity. The ring has been divided into 6 equal segments, accounting for about 17%~35%~51%~68%~85%~100%. When discharging, the blue segments of the ring will disappear according to the real-time left capacity. When recharging, the blue ring will be

flashed clockwise along the trajectory, and the digital number will show you the real-time input charging power. After full charge, the whole blue ring will light up and remain stable. After charging, please unplug the adapter.

CAUTION

- There will be efficiency loss of the input power which displays on the LCD screen.
- Please charge the Product at the ambient temperature of 0-40°C.
- Must make sure that the connection is in good contact , and adapter work normally, otherwise, it may cause potential safety hazards.
- In order to reduce the power consumption and prolong the battery lifetime of the Product, please turn off all the switches when it is not in use.

4.1 3 Different Recharging Ways

4.1.1 Standard AC Adapter

Please connect the 7909 input charge port of the Product and wall outlet with our standard 200W AC Adapter , it will take about 6.5

hours to full charge.

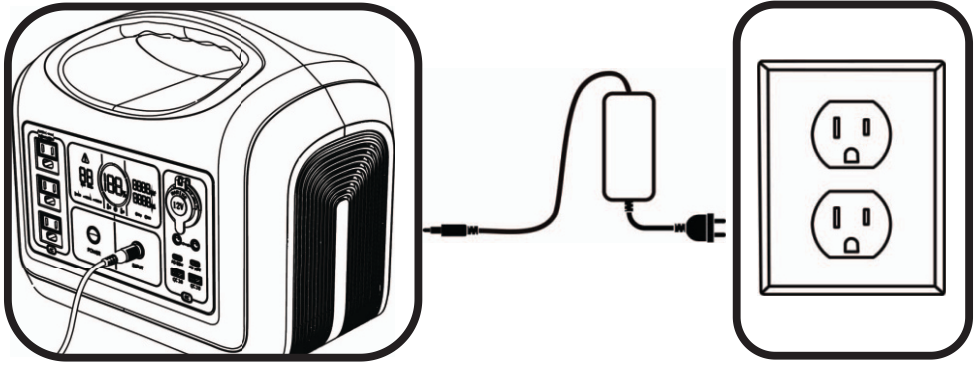

CAUTION

Please use our standard solar panels and adapters to charge the device, otherwise the device may not charge normally. In severe cases, the lifespan will be reduced, and the device may be damaged due to a short circuit.

4.1.2 Car Charger

Please connect the input 7909 charging port and the vehicle's 12V cigarette output port with our standard 7909 transfer cables. It will take at least 12 hours to full charge.



4.1.3 Solar Panels

Two 100W solar panels are connected to the 7909 input port of the product by using the 7909 adapter cable of the product accessory 1-2. At this time, the blue energy bar on the screen scrolls and the input power is displayed, which indicates that the product has started charging. The solar charging power that can be input by the product is related to the intensity of illumination. The stronger the illumination, the greater the input power, which can support 240W photovoltaic input at most.

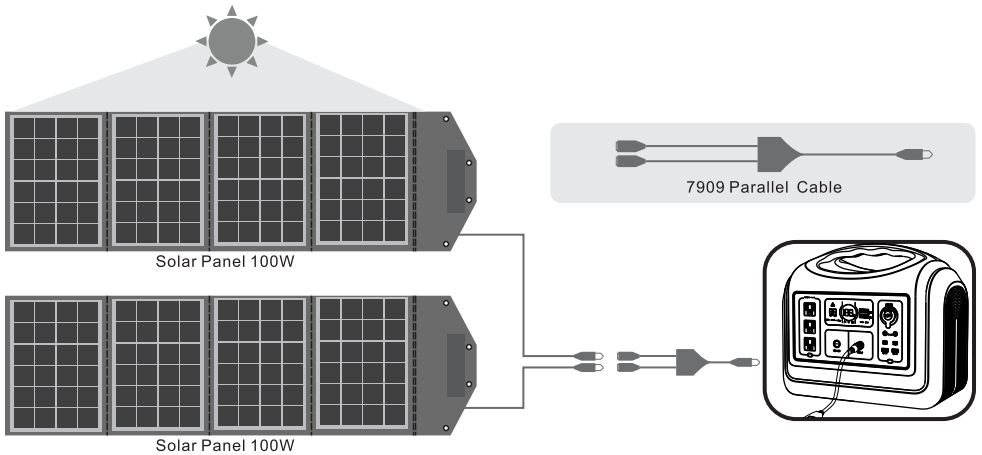

CAUTION

Please use our standard solar panels and adapters to charge the device, otherwise the device may not charge normally. In severe cases, the lifespan will be reduced, and the device may be damaged due to a short circuit.

4.2 AC Output Instructions



Main Power Switch

POWER ON: Long press the main power button for 3 seconds, the background light around the button will lit up , and the LCD screen will light up too, the blue battery ring and battery percentage will display.

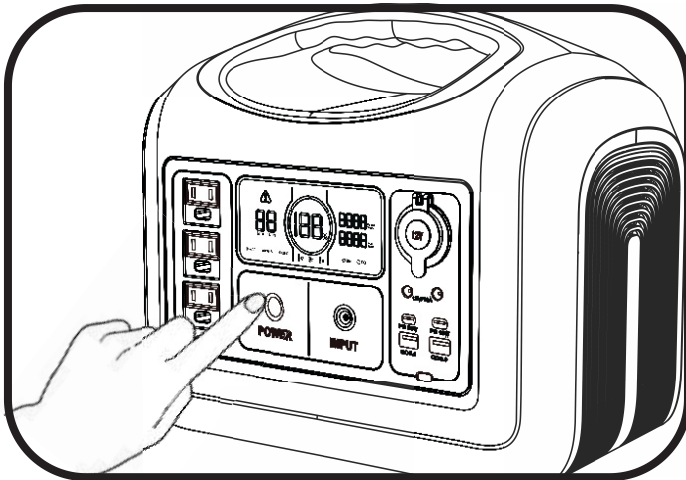







POWER OFF: Long press the main power button for 3 seconds, the background light and LCD screen will be off at the same time.



4.2.1 AC Output Instructions

When the main power button is turned on, gently press the AC Output button ②, the icon  in the LCD screen will lit up. It means the function of this area can be used normally. Press this button again, the icon  will disappear, and the function of this area will stop working.

4.2.2 DC Output Instructions







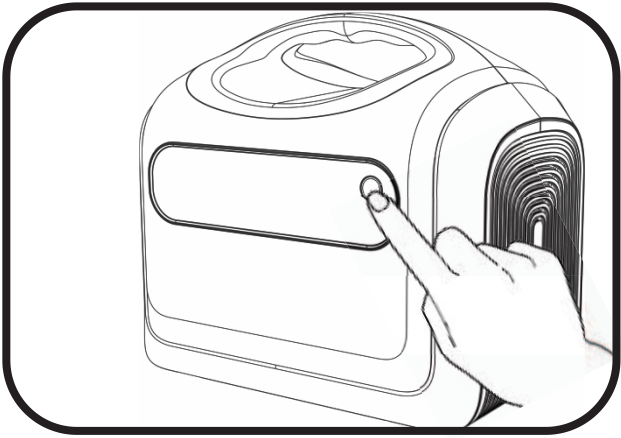





When the main power button is on, press the power button ⑧ , all the function in the DC output zone will be activated, and the corresponding icons  ,  ,  and  on the LCD screen will lit up, the car charge and DC ports in the area can work normally; Press the power button again, the corresponding icons  ,  ,  and  on the LCD screen will go out, and the functions in the area stop working.

4.3 LED Light Instructions

In the main power on state. The power on/off button is on the other side. Press once, 50% brightness, press again, 100% brightness, then press again, it will change to SOS flashing mode, and press once more to power off.



5. Appliances Run Time Instructions

Icons	Appliances	Run time
	3110mAh phone	65 times
	30Wh Tablet PC	29 times
	60Wh Laptop	15 times
	10W Light	87 hours
	16Wh Camera	55 times
	60Wh Drone	15 times
	50W Mini Cooler	17.5 hours
	30W Fanner	29 hours
	30Wh Electric Tool	29 times
	10W WIFI	87 hours
	110W TV	7.9 hours
	40W Ventilator	21.8 hours

6. Frequency switching operation

1. In the power-on state, turn off the AC output, and press the main power button & the DC button(USB output) at the same time to enter the switching frequency menu;
2. Press the AC output button to switch the frequency, the setting the frequency will be flashing;
3. Long press the main power button to set the frequency, SUC will be displayed if the setting is successful, and then long press the main power button to exit the setting menu.

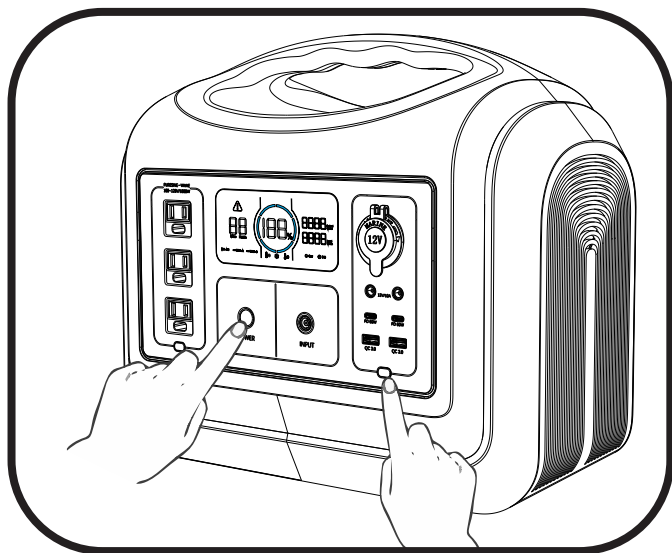

7. Storage and Maintenance











- When the device is not in use, please turn off all switches to reduce product power consumption and prolong the product battery lifetime;
- Please keep the surface of the product clean, ensure that the product does not contact gasoline, volatile oil, thinner, kerosene, etc., to avoid corrosion of the product shell;
- Please store the product in a dry, ventilated and dustless environment. Storage temperature range in 0~40°C, avoid direct sunlight;
- Please fully charged the battery before storage, and charge it at least once every 6 months, to avoid dormancy of the battery, which will affect normal use;
- If the product needs to be transported long distance, please keep the battery power between 40%~60%, otherwise there will be potential safety risks.

8. Main Technical Specification

Output Technical Parameters		
AC Output	Rated Voltage	100~120Vac
	Rated Power	1200W
	Peak Power	3600W
	Frequency	60Hz/50Hz
DC 12V & Car lighter Output	Rated Voltage	12V
	Rated Power	10A
USB-A Output	5V/3A; 9V/2A; 12V/1.5A (18W Max)	
USB-C Output	5V/3A; 9V/3A; 12V/3A; 15V/3A; 20V/3A 【PD60W (left) /PD18W (right) 】	
LED Light	Press once, 50% brightness, press again, 100% brightness, then press again, it will change to SOS flashing mode, and press once more to power off.	
Input		
Input Voltage	12V~30V	
AC7909 Input Power	200W Max	

Battery	
Rated Capacity	992 Wh
Rated Voltage	32 Vac
Battery Type	LiFePO ₄
Common Information	
IP Grade	IP21
Working Temperature	0~40°C
Dimensions	12.99 x 8.66 x 11.37in (330*220*289mm)
Net Weight	24.2lb (11.0kg)

9. Fault Code and Trouble Shooting

Code	Description	Performance	Trouble Shooting
E000	AC Short Circuit Protection	 AC +  flashing, no output	Press the AC Output Power on/off button for recovery.
E001	Over Load Production	 AC +  DC +  flashing, no output	Flashing icons indicates which circuit overload. Press corresponding button for recovery.
E002	Battery Low Voltage Protection	Related function icons flashing , Corresponding terminals no output	Press corresponding button for recovery.
E003	AC&DC Output run simultaneously, system overload	 AC flashing, AC no output	AC&DC Output run at the same time, the total load power is over 1200W. Shut down the AC output, or lower down the load of AC output,priority support the DC output.
E004	Inverter fault	 AC +  flashing, no output	Inverter output voltage too high/low; Inverter over temperature; DC main line voltage too high/low;Loaded current abnormal.
E005	BMS fault	 flashing, other function icons Can't lit up, no output	Charge over voltage protection; Discharge under voltage protection; High Temperature Protection; Low Temperature Protection; Short Circuit Protection.
E006	Input voltage is too high&low	 +  flashing, no input	Please ensure that the input voltage is within the 12-30V.