

# Multi RS Solar

Rev 06 - 10/2022

This manual is also available in [HTML5](#).

# Table of Contents

<b>1. Multi RS Solar Product Manual</b> .....	<b>1</b>
<b>2. Safety Instructions</b> .....	<b>2</b>
<b>3. General Description</b> .....	<b>4</b>
3.1. Two AC outputs .....	4
3.2. PowerControl - maximum use of limited AC power .....	4
3.3. PowerAssist - Extended use of AC input current .....	4
3.4. Programmable .....	4
3.5. Programmable relay .....	4
3.6. Programmable analog/digital input/output ports .....	4
3.7. Built-in Battery Monitor .....	4
3.8. High efficiency .....	4
3.9. Frequency shift function .....	5
3.10. High power inverter .....	5
3.11. Interfacing and Communications .....	5
3.12. Battery charger .....	6
3.12.1. Lead-acid batteries .....	6
3.12.2. Li-ion batteries .....	6
3.12.3. More on batteries and battery charging .....	6
3.13. Setup options .....	6
3.14. Limitations .....	7
<b>4. Installation</b> .....	<b>8</b>
4.1. Location of the inverter .....	8
4.2. Battery and battery lead requirements .....	8
4.3. Solar array configuration .....	9
4.3.1. Multi RS Solar Example PV Configuration .....	9
4.4. MPPT grounding, detection of PV array insulation faults & Earth fault alarm notification .....	10
4.5. Cable connection sequence .....	10
4.6. Battery Connection procedure .....	10
4.7. Connection of the AC cabling .....	11
4.8. VE.Direct .....	11
4.9. VE.Can .....	12
4.10. Bluetooth .....	12
4.11. User I/O .....	12
4.11.1. Remote on/off connector .....	12
4.11.2. Programmable relay .....	12
4.11.3. Voltage sense .....	12
4.11.4. Temperature sensor .....	12
4.11.5. Programmable analog/digital input ports .....	13
4.11.6. User I/O terminal diagram .....	13
4.11.7. User I/O functions .....	13
4.12. Programming with VictronConnect .....	13
4.12.1. Settings .....	14
4.12.2. Battery settings .....	14
4.13. Connecting to AC PV inverters .....	17
<b>5. Operation</b> .....	<b>18</b>
5.1. Device display .....	18
5.2. History - Thirty-day graphic .....	19
5.3. Protections and automatic restarts .....	20
5.3.1. Overload .....	20
5.3.2. Low battery voltage thresholds (adjustable in VictronConnect) .....	21
5.3.3. High battery voltage .....	21
5.3.4. High temperature .....	21
<b>6. Troubleshooting Guide - MPPT</b> .....	<b>22</b>
6.1. Troubleshooting and Support .....	22
6.2. The controller is not operational .....	22
6.2.1. Visual check .....	22
6.2.2. Battery supply check .....	22

6.3. Batteries are not charged .....	22
6.3.1. Battery supply issue .....	23
6.3.2. Reverse battery polarity .....	24
6.3.3. PV voltage too low .....	24
6.3.4. Reverse PV polarity .....	25
6.3.5. PV voltage too high .....	25
6.3.6. Battery full .....	26
6.3.7. The charger is disabled .....	26
6.3.8. Controlled by an external device .....	26
6.4. Batteries are undercharged .....	26
6.4.1. The battery is almost full .....	26
6.4.2. Too much DC load .....	27
6.4.3. Insufficient solar .....	27
6.4.4. Battery charge current too low .....	27
6.4.5. Battery charge voltages are too low .....	27
6.4.6. Battery cable voltage drop .....	27
6.4.7. Wrong temperature compensation setting .....	28
6.5. Batteries are overcharged .....	28
6.5.1. Battery charge voltages too high .....	29
6.5.2. Battery unable to deal with equalization .....	29
6.5.3. Battery old or faulty .....	29
6.6. Solar issues .....	30
6.6.1. PV reverse current too high .....	30
6.6.2. PV yield less than expected .....	30
6.6.3. Full rated output not reached .....	31
6.6.4. Mixed PV panel types .....	31
6.6.5. MC4 connectors wrongly connected .....	31
6.6.6. PV connections burned or melted .....	31
6.6.7. Optimisers cannot be used .....	32
6.6.8. Ground current .....	32
6.7. Communication issues .....	32
6.7.1. VictronConnect issues .....	32
6.7.2. Bluetooth issues .....	32
6.7.3. VE.Direct port communication issues .....	33
6.7.4. VE.Smart communication issues .....	33
6.8. Settings or firmware issues .....	33
6.8.1. Incorrect settings .....	33
6.8.2. Firmware issues .....	33
6.8.3. Interrupted firmware update .....	34
6.9. Operation issues .....	34
6.9.1. Unable to operate as a power supply .....	34
6.9.2. Relay issues .....	34
6.10. Errors, and error codes .....	34
6.10.1. Error codes .....	35
6.11. Warranty .....	36
<b>7. Technical Specifications .....</b>	<b>37</b>
<b>8. Appendix .....</b>	<b>39</b>
8.1. Appendix A : Connection Overview .....	39
8.2. Appendix B : Block Diagram .....	41
8.3. Appendix C : Example Wiring Diagram .....	42
8.4. Appendix D : Dimensions .....	44
8.5. Error Codes .....	45
8.5.1. Error 2 - Battery voltage too high .....	45
8.5.2. Error 3, Err 4 - Remote temperature sensor failure .....	45
8.5.3. Error 5 - Remote temperature sensor failure (connection lost) .....	45
8.5.4. Error 6, Error 7 - Remote battery voltage sense failure .....	45
8.5.5. Error 8 - Remote battery voltage sense failure (connection lost) .....	45
8.5.6. Error 11 - Battery high ripple voltage .....	45
8.5.7. Error 14 - Battery low temperature .....	45
8.5.8. Error 20 - Maximum Bulk-time exceeded .....	45
8.5.9. Error 22, 23 - Internal temperature sensor failure .....	45
8.5.10. Error 26 - Terminal overheated .....	45
8.5.11. Error 27 - Charger short circuit .....	46
8.5.12. Error 28 - Power stage issue .....	46
8.5.13. Error 29 - Over-Charge protection .....	46
8.5.14. Error 43 - Inverter shutdown (Ground Fault) .....	46

8.5.15. Error 50, Error 52 - Inverter overload, Inverter peak current .....	46
8.5.16. Error 51 - Inverter temperature too high .....	46
8.5.17. Error 53, Error 54 - Inverter output voltage .....	46
8.5.18. Error 55, Error 56, Error 58 - Inverter self test failed .....	46
8.5.19. Error 57 - Inverter ac voltage on output .....	47
8.5.20. Notification 65 - Communication warning .....	47
8.5.21. Notification 66 - Incompatible device .....	47
8.5.22. Error 67 - BMS Connection lost .....	47
8.5.23. Error 68 - Network misconfigured .....	47
8.5.24. Error 114 - CPU temperature too high .....	47
8.5.25. Error 116 - Calibration data lost .....	47
8.5.26. Error 119 - Settings data lost .....	47
8.5.27. Error 121 - Tester fail .....	48
8.5.28. Err 200, X95 - Internal DC voltage error .....	48
8.5.29. Err 201 - Internal DC voltage error .....	48
8.5.30. Err 203, Err 205, Err 212, Err 215 - Internal supply voltage error .....	48

# 1. Multi RS Solar Product Manual

## Introduction

---

The Victron Multi RS Solar integrates the following elements:

- A powerful inverter/charger
- A high power MPPT solar charge controller

This document explains:

- Features
- Behaviour
- Specifications
- Limitations
- Installation instructions
- Troubleshooting steps

You must read it to understand how to use your product safely and reliably.

This manual applies to:

- Multi RS Solar 48/6000/100-450/80 1 tracker - PMR482602000



**IMPORTANT** - The Multi RS Solar has limitations and restrictions that are subject to change with updates to firmware - please contact your Victron Dealer or Victron Sales Manager prior to purchase to understand these limitations and if this product is suitable for your specific application. For example, generator input support requires a future firmware update.

## 2. Safety Instructions



### ELECTRIC SHOCK HAZARD

Please read this manual carefully before the product is installed and put into use.

This product is designed and tested in accordance with international standards. The equipment should be used for the designated application only.

Refer to the specifications provided by the manufacturer of the battery to ensure that the battery is suitable for use with this product. The battery manufacturer's safety instructions should always be observed.

Protect the solar modules from incident light during installation, e.g. cover them.

Never touch uninsulated cable ends.

Use only insulated tools.

Connections must always be made in the sequence described in the installation section of this manual.

The installer of the product must provide a means for cable strain relief to prevent the transmission of stress to the connections.

In addition to this manual, the system operation or service manual must include a battery maintenance manual applicable to the type of batteries used. The battery must be placed in a well-ventilated area.



### SELECTION OF WIRE CONDUCTORS

Use flexible multistranded copper cable for the battery and PV connections.

The maximum diameter of the individual strands is 0,4mm/0,125mm<sup>2</sup> (0.016 inch/AWG26).

A 25mm<sup>2</sup> cable, for example, should have at least 196 strands (class 5 or higher stranding according to VDE 0295, IEC 60228 and BS6360).

An AWG2 gauge cable should have at least 259/26 stranding (259 strands of AWG26)

Maximum operating temperature:  $\geq 90^{\circ}\text{C}$

Example of suitable cable: class 5 "Tri-rated" cable (it has three approvals: American (UL), Canadian (CSA) and British (BS)).

In case of thicker strands the contact area will be too small and the resulting high contact resistance will cause severe overheating, eventually resulting in fire.



### RISK OF INJURY OR DEATH

The internals can carry a 400-500V DC voltage even when the product is off!

Input and/or output terminals may still be dangerously energized, even when the equipment is switched off. Always disconnect all power connections (e.g. the battery, DC solar isolator, etc) and wait at least 5 minutes before carrying out work on the product.

The product has no internal user-serviceable components. Do not remove the front plate or operate the product if any panels have been removed. All servicing must be undertaken by qualified personnel.

Please read the installation instructions in the installation manual before installing the equipment.

This is a Safety Class I product (supplied with a protective grounding terminal). The chassis must be grounded. Whenever it is likely that the grounding protection has been damaged, the product must be turned off and secured against unintended operation; please contact qualified service staff.

#### Environment and Access

Ensure that the equipment is used under the correct ambient conditions. Never operate the product in a wet or dusty environment. Never use the product where there is a risk of gas or dust explosions. Ensure there is adequate free space for ventilation above and below the product and check that the ventilation vents are not blocked.

Installation of this product must in a location that restricts access by persons (including children) with reduced physical, sensory or mental capabilities, or lack of experience and knowledge, unless they have been given supervision or instruction concerning use of the appliance by a person responsible for their safety.

The connections to live parts should be covered after installation.

## 3. General Description

The Multi RS Solar is a combined inverter/charger and MPPT solar charger.

It is designed to operate with a 48V battery bank and produces a pure AC sine wave at 230V.

### 3.1. Two AC outputs

Besides the usual uninterruptible output (AC-out-1), an auxiliary output (AC-out-2) is available that disconnects its load in the event of battery-only operation. Example: an electric boiler that is allowed to operate only if the AC input is available. There are several applications for AC-out-2.

### 3.2. PowerControl - maximum use of limited AC power

The product can supply a huge charging current. This implies heavy loading of the AC input. Therefore a maximum current can be set. The product then takes other power users into account, and only uses 'surplus' current for charging purposes.

### 3.3. PowerAssist - Extended use of AC input current

This feature takes the principle of PowerControl to a further dimension allowing the product to supplement the capacity of the alternative source. Where peak power is often required only for a limited period, the product will make sure that insufficient AC input power is immediately compensated for by power from the battery. When the load reduces, the spare power is used to recharge the battery.

### 3.4. Programmable

All programmable settings for this product can be changed with either a mobile phone or computer (Windows requires VE.Direct to USB dongle), using the free VictronConnect software available on the App Store of your device, or [www.victronenergy.com](http://www.victronenergy.com).

### 3.5. Programmable relay

The product is equipped with a programmable relay. The relay can be programmed for different applications, for example as a starter relay.

### 3.6. Programmable analog/digital input/output ports

The product is equipped with 2 analog/digital input/output ports.

These ports can be used for several purposes. One application is communication with the allow-to-charge and allow-to-discharge BMS controls of a lithium-ion battery.

See appendix.

### 3.7. Built-in Battery Monitor

The ideal solution when the product is part of a hybrid system (AC input, inverter/chargers, storage battery, and alternative energy). The built-in battery monitor can be set to open and close the relay:

- start at a preset % discharge level
- start (with a preset delay) at a preset battery voltage
- start (with a preset delay) at a preset load level
- stop at a preset battery voltage
- stop (with a preset delay) after the bulk charge phase has been completed
- stop (with a preset delay) at a preset load level

### 3.8. High efficiency

**Outstanding inverter/charger efficiency** - Maximum efficiency of 96%. The inverter is short circuit proof and protected against overheating, whether due to overload or high ambient temperature.



**Ultra-fast Maximum Power Point Tracking (MPPT)** - Especially in case of a clouded sky, when light intensity is changing continuously, a fast MPPT algorithm will improve energy harvest by up to 30% compared to PWM charge controllers and by up to 10% compared to slower MPPT controllers.

**Advanced Maximum Power Point Detection in case of partial shading conditions** - If partial shading occurs, two or more maximum power points may be present on the power-voltage curve. Conventional MPPTs tend to lock to a local MPP, which may not be the optimum MPP. The innovative SmartSolar algorithm will always maximize energy harvest by locking to the optimum MPP.

### 3.9. Frequency shift function

When external PV inverters are connected to the output of the inverter, excess solar energy is used to recharge the batteries. Once the battery absorption voltage is reached, charge current will reduce by shifting the output frequency higher. This frequency shift is automatic and does not require configuration on the Multi RS Solar, though the AC PV inverter may require additional configuration. This feature is used for battery over charge protection and solar assist. It does not allow charging the battery from an AC PV inverter to fully 100% State of Charge. To complete a full charge from solar, connect PV to the internal MPPT solar charger, or another DC MPPT.

### 3.10. High power inverter

**High peak power** - The inverter is able to supply a maximum AC output power to a peak 9000W or 50A AC, for 3 seconds. This supports smooth operation for motor start up and other demanding surge loads.

**Continuous power output, with solar boost** - Continuous output power at 25C ambient, at 52VDC, is 5300W. When combined with solar power from the built-in MPPT this increases approximately 10% to 5800W.

**Isolated PV connections for additional safety** - Full galvanic isolation between PV and battery connections provide additional overall system safety.

**Temperature Protected** - Over-temperature protection and power derating when temperature is high.

### 3.11. Interfacing and Communications

#### VE.Direct port and two VE.Can ports

The Multi RS Solar only supports a data connection to a GX device (i.e Cerbo GX) via the VE.Can port, and not the VE.Direct port. The VE.Direct port can be used to connect a GlobalLink 520 for remote data monitoring, or USB to VE.Direct dongle for VictronConnect access on a Windows computer.

#### Device Display

A 4 line LCD back-lit display shows operational information including battery levels, solar yield, and system icons.

#### User I/O connector:

- Aux 1, 2 input
- Programmable relay
- Battery voltage sense (Vsense)
- Battery temperature sense (Tsense)
- Remote H & Remote L - Configurable

#### Bluetooth Smart built-in

The wireless solution to set-up, monitor and update the controller using Apple and Android smartphones, tablets or other compatible devices.

#### Configuring and monitoring with VictronConnect

Configure with the VictronConnect app. Available for iOS, Android devices, as well as macOS and Windows computers. A VE.Direct to USB accessory is required for Windows systems; enter VictronConnect in the search box on our website and see the VictronConnect download page for details.

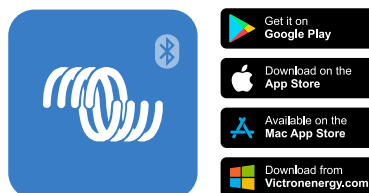

## 3.12. Battery charger

The batteries can be charged by solar energy using the built-in MPPT solar controller, a compatible AC supply connected to the AC input, or an AC PV grid inverter connected to the AC output. The built-in MPPT has a power limit of 4000W. So the maximum charging current for a 50V battery will be 80A. If an additional PV grid inverter is connected (max 5000W) the maximum total charging current is limited to 100A. The maximum charging current of 100A is reduced if battery voltage goes above 60V. A custom maximum charge current value can also be defined by the installer in VictronConnect. If using a PV grid inverter, it will only charge the battery to ~95%.

The charger algorithm is the same as for the BlueSolar MPPT solar controllers. This provides built-in battery preset parameters, and allows for expert mode to define additional charging parameters.

### 3.12.1. Lead-acid batteries

#### Adaptive 4-stage charge algorithm: bulk – absorption – float – storage

The microprocessor-driven adaptive battery management system can be adjusted for various types of batteries. The adaptive function automatically adapts the charging process to battery use.

#### The right amount of charge: variable absorption time

In the event of slight battery discharge, absorption is kept short to prevent overcharging and excessive gas formation. After deep discharging, the absorption time is automatically extended in order to fully charge the battery.

#### Preventing damage due to excessive gassing: the BatterySafe mode

If, in order to quickly charge a battery, a high charge current in combination with a high absorption voltage has been chosen, damage due to excessive gassing will be prevented by automatically limiting the rate of voltage increase once the gassing voltage has been reached.

#### Less maintenance and aging when the battery is not in use: the Storage mode

The Storage mode kicks in whenever the battery has not been subjected to discharge during 24 hours. In the Storage mode float voltage is reduced to 2,2V/cell to minimise gassing and corrosion of the positive plates. Once a week the voltage is raised back to the absorption level to 'equalize' the battery. This feature prevents stratification of the electrolyte and sulphation, a major cause of early battery failure.

#### Battery voltage sense: the correct charge voltage

Voltage loss due to cable resistance can be compensated by using the voltage sense facility to measure voltage directly on the DC bus or on the battery terminals.

#### Battery voltage and temperature compensation

The temperature sensor (supplied with the product) serves to reduce charging voltage when battery temperature rises. This is particularly important for maintenance-free batteries, which could otherwise dry out by overcharging.

### 3.12.2. Li-ion batteries

#### Victron LiFePO4 Smart batteries

When using Victron lithium batteries, the system will need to be wired using the allow to charge, and allow to discharge contacts from the Victron smallBMS to the I/O connection port. This will also need to be configured to BMS mode when commissioning the product in VictronConnect.

#### Compatible BMS-Can Lithium Batteries

Compatible BMS-Can lithium batteries can be used with Multi RS Solar however it is a requirement that those batteries to be connected via the BMS-Can port of the GX device (such as the Cerbo GX), and not to the Multi RS Solar communications interface directly. See the [Victron Battery Compatibility Guide for more specific information](#).

### 3.12.3. More on batteries and battery charging

Our book 'Energy Unlimited' offers further information on batteries and battery charging, and is available free of charge on our website: <https://www.victronenergy.com/support-and-downloads/technical-information>.

For more information on adaptive charging, please also refer to the General Technical Information on our website.

Victron provides a comprehensive Online Training program via the <https://www.victronenergy.com.au/information/training> web portal. Successful completion of this training should be considered essential for system designers and installers, and is recognised with a graduation certificate.

## 3.13. Setup options

### Adaptive three step charging

The Charge Controller is configured for a three step charging process: Bulk – Absorption – Float.

A regular equalization charge can also be programmed.

**Bulk**- During this stage the controller delivers as much charge current as possible to rapidly recharge the batteries.

**Absorption** - When the battery voltage reaches the absorption voltage setting, the controller switches to constant voltage mode. When only shallow discharges occur the absorption time is kept short in order to prevent overcharging of the battery. After a deep discharge the absorption time is automatically increased to make sure that the battery is completely recharged.

Additionally, the absorption period is also ended when the charge current decreases to less than 2A.

**Float** - During this stage, float voltage is applied to the battery to maintain a fully charged state.

#### **Optional external voltage and temperature sensor**

Wired connections are available for battery voltage and temperature sensing. The Solar Charger uses these measurements to optimize its charge parameters. The accuracy of the data it transmits will improve battery charging efficiency, and prolong battery life.

The Smart Battery Sense and other VE.Smart networking features are not currently supported.

#### **Remote on-off input**

Remote L functions as 'allow to charge' in case lithium battery is selected and remote H functions as 'allow to discharge'. Use smallBMS for the RS with Victron lithium batteries.

#### **Programmable relay**

Can be programmed (with a smartphone) to open or close on an alarm, or other events.

## **3.14. Limitations**

#### **Generators are not yet supported**

The Multi RS does not yet support generator input. The Multi RS will most likely not synchronise to a generator input, or drop out when loads are applied. Generator support is expected to be added with a future firmware update, however it is not yet known which model generators will be supported, nor what further limitations there will be.

#### **ESS is not supported**

The Multi RS does not yet support grid codes, and therefore does not yet support ESS installations. It is not yet known if the current hardware revision will be able to support grid codes, or ESS, via a firmware update in the future.

#### **Assistants and advanced controls are not supported**

The Multi RS will not support VE.Configure assistants programming. Customisation and controls are currently limited to what is displayed in the Multi RS settings in VictronConnect. You can use the Multi RS demo mode in VictronConnect to see what features are currently available. We expect additional similar control functionality to be added over time to VictronConnect.

#### **Single phase support only**

The Multi RS currently only supports single phase, single unit installations. It does not yet support any other phase configurations (i.e three phase). It is not yet known if the current hardware revision will be able to support additional phases configurations via a firmware update in the future.





#### **Parallel units are not supported**

The Multi RS does not support synchronising AC output sine waves between parallel Multi RS units. It is not yet known if the current hardware revision will be able to support parallel configurations via a firmware update in the future.

## 4. Installation

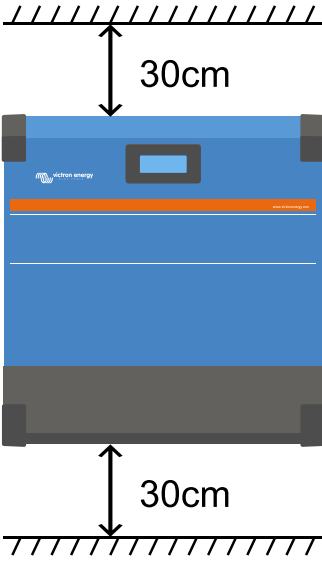
### 4.1. Location of the inverter

Table 1.

 <p>The diagram shows a blue Victron Energy inverter mounted vertically. Two double-headed arrows indicate a 30cm clearance above the top of the inverter and a 30cm clearance below the bottom of the inverter, both measured from a hatched surface representing a wall or ceiling/floor.</p>	<p>To ensure a trouble free operation of the inverter, it must be used in locations that meet the following requirements:</p> <ol style="list-style-type: none"> <li>Avoid any contact with water. Do not expose the inverter to rain or moisture.</li> <li>Do not place the unit in direct sunlight. Ambient air temperature should be between <math>-20^{\circ}\text{C}</math> and <math>40^{\circ}\text{C}</math> (humidity <math>&lt; 95\%</math> non-condensing).</li> <li>Do not obstruct the airflow around the inverter. Leave at least 30 centimeters clearance above and below the inverter, and preferably installed upright and vertical.</li> </ol> <p>When the unit is running too hot, it will shut down. When it has reached a safe temperature level the unit will automatically restart again.</p>
	<p>This product contains potentially dangerous voltages. It should only be installed under the supervision of a suitable qualified installer with the appropriate training, and subject to local requirements. Please contact Victron Energy for further information or necessary training.</p>
	<p>Excessively high ambient temperature will result in the following:</p> <ul style="list-style-type: none"> <li>Reduced service life.</li> <li>Reduced charging current.</li> <li>Reduced peak capacity, or shutdown of the inverter.</li> </ul> <p>Never position the appliance directly above lead-acid batteries. The unit is suitable for wall mounting. For mounting purposes, a hook and two holes are provided at the back of the casing. The device must be fitted vertically for optimal cooling.</p>
	<p>For safety purposes, this product should be installed in a heat-resistant environment. You should prevent the presence of e.g. chemicals, synthetic components, curtains or other textiles, etc., in the immediate vicinity.</p>

**Try and keep the distance between the product and the battery to a minimum in order to minimise cable voltage losses**

### 4.2. Battery and battery lead requirements

In order to utilize the full capacity of the product, batteries with sufficient capacity and battery cables with sufficient cross section should be used. The use of undersized batteries or battery cables will lead to:

- Reduction in system efficiency.
- Unwanted system alarms or shutdowns.
- Permanent damage to system.

See table for MINIMUM battery and cable requirements.

Model		48/100
Battery capacity Lead-acid		200 Ah
Battery capacity Lithium		50 Ah
Recommended DC fuse		125 A - 150 A
Minimum cross section (mm <sup>2</sup> ) per + and - connection terminal	0 - 2 m	35 mm <sup>2</sup>
	2 - 5 m	70 mm <sup>2</sup>



Consult battery manufacture recommendations to ensure the batteries can take the total charge current of the system. Decision on battery sizing should be made in consultation with your system designer.



Use a torque wrench with insulated box spanner in order to avoid shorting the battery.

**Maximum torque: 14 Nm**

Avoid shorting the battery cables.

- Undo the two screws at the bottom of the enclosure and remove the service panel.
- Connect the battery cables.
- Tighten the nuts well for minimal contact resistance.

### 4.3. Solar array configuration

The Multi RS Solar single tracker model contains multiple PV input connectors. However these are internally connected to one single Maximum Power Point Tracker. It is strongly recommended that the connected strings are made with the same number and type of panels.

The maximum operational input current for each tracker is 18 A.

MPPT PV inputs are protected against reverse polarity, to a maximum short circuit current of 20 A for each tracker.

Connecting PV arrays with a higher short circuit current is possible, up to an absolute maximum of 30A, as long as connected with correct polarity. This outside of specification potential allows for system designers to connect larger arrays, and can be useful to understand in case a certain panel configuration results in a short circuit current just slightly above the maximum of the reverse polarity protection circuit.



**BEWARE** that the product warranty will be void if a PV array with a short circuit current larger than 20 A array is connected in reverse polarity.



The Multi RS Solar single tracker model contains multiple PV input connectors. However these are internally connected to one single Maximum Power Point Tracker. It is strongly recommended that the connected strings are made with the same number and type of panels.

When the MPPT switches to float stage it reduces battery charge current by increasing the PV Power Point voltage.

The maximum open circuit voltage of the PV array must be less than 8 times the minimum battery voltage when at float.

For example, where a battery has a float voltage of 54.0 volts, the maximum open circuit voltage of the connected array cannot exceed 432 volts.

Where the array voltage exceeds this parameter the system will give a "Over-charge Protection" error and shut down.

To correct this, either increase the battery float voltage, or reduce PV voltage by removing PV panels from the string to bring the voltage back within specification.

#### 4.3.1. Multi RS Solar Example PV Configuration



This is an example of an array configuration. The decision on the specific array configuration, sizing and design for your system should be made in consultation with your system designer.

**Table 2. PV Array Example**

Panel Type	Voc	Vmpp	Isc	Impp	# of panels	Max String Voltages	Power total
Victron 260W (60 cell)	36.75 V	30 V	9.30 A	8.66 A	#1 - 8 #2 - 8	304 V	4160 W

#### 4.4. MPPT grounding, detection of PV array insulation faults & Earth fault alarm notification

The RS will test for sufficient resistive isolation between PV+ and GND, and PV- and GND.

In the event of a resistance below the threshold (indicating an earth fault), the unit will stop charging and display the error.

If an audible alarm and/or email notification of this fault is required, then you must also connect a GX device (such as the Cerbo GX). Email notifications require an internet connection to the GX device and a VRM account to be configured.

The positive and negative conductors of the PV array must be isolated from ground.

Ground the frame of the PV array to local requirements. The ground lug on the chassis should be connected to the common earth.

The conductor from the ground lug on the chassis of the unit to earth should have at least the cross-section of the conductors used for the PV array.

When a PV resistance isolation fault is indicated, do not touch any metal parts and immediately contact a suitably qualified technician to inspect the system for faults.

The battery terminals are galvanically isolated from the PV array. This ensures that PV array voltages cannot leak to the battery side of the system in a fault condition.

#### 4.5. Cable connection sequence

**First:** Confirm correct battery polarity, connect the battery.

**Second:** if required, connect the remote on-off, and programmable relay, and communications cables

**Third:** Confirm correct PV polarity, and then connect the solar array (if incorrectly connected with reverse polarity, the PV voltage will drop, the controller will heat up but will not charge the the battery).

#### 4.6. Battery Connection procedure

Proceed as follows to connect the battery cables:



Use a torque wrench with insulated box spanner in order to avoid shorting the battery. Avoid shorting the battery cables.



Specific care and attention must be taken when making the battery connections. Correct polarity must be confirmed with a multimeter before connection. Connecting a battery with incorrect polarity will destroy the device and is not covered by warranty.

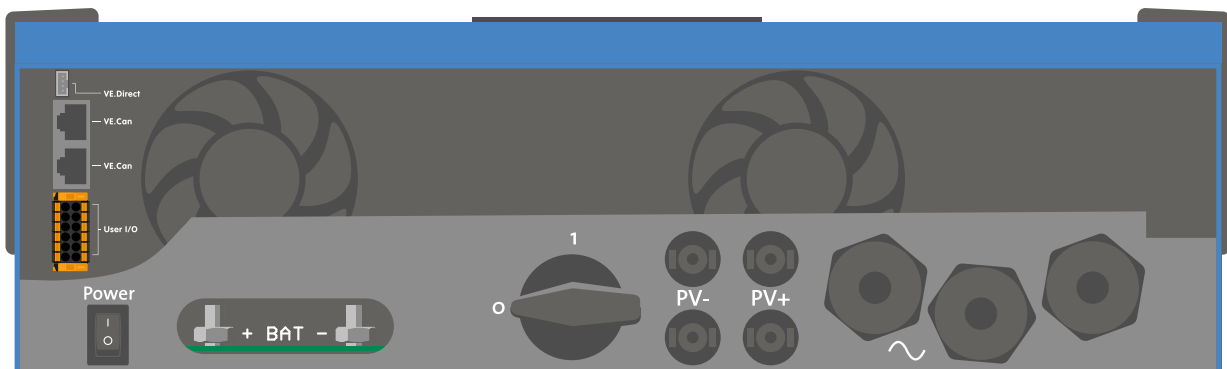

- Undo the two screws at the bottom of the enclosure and remove the service panel.
- Connect the battery cables. First the - cable then the +. Be aware that there may be a spark when making the battery connections.

- Tighten the nuts to the prescribed torques for minimal contact resistance.

## 4.7. Connection of the AC cabling

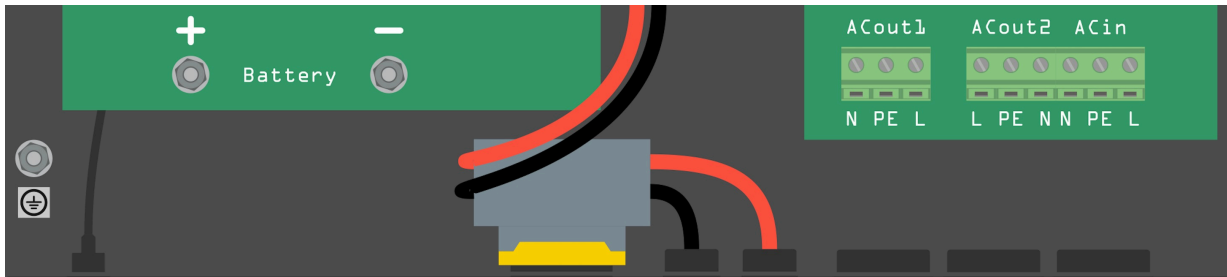

This is a safety class I product (supplied with a ground terminal for safety purposes). **Its AC input and/or output terminals and/or grounding point on the inside of the product must be provided with an uninterruptible grounding point for safety purposes.** see Appendix A.

In a fixed installation, an uninterruptible grounding can be secured by means of the grounding wire of the AC input. Otherwise the casing must be grounded.

This product is provided with a ground relay (relay H, see Appendix B) that **automatically connects the Neutral output to the chassis if no external AC supply is available.** If an external AC supply is provided, the ground relay H will open before the input safety relay closes. This ensures the correct operation of an earth leakage circuit breaker that is connected to the output.

In a mobile installation (for example, with a shore current plug), interrupting the shore connection will simultaneously disconnect the grounding connection. In that case, the casing must be connected to the chassis (of the vehicle) or to the hull or grounding plate (of the boat). In case of a boat, direct connection to the shore ground is not recommended because of potential galvanic corrosion. The solution to this is using an isolation transformer.

The terminal blocks can be found on the printed circuit board, see Appendix A.

### Do not invert neutral and phase when connecting the AC.

The inverter does **NOT** provide full galvanic isolation between the PV DC input and AC output. Therefore it is possible that DC voltage and current from the DC PV connections could be detected on the AC side.

Full galvanic isolation is provided between PV DC, and Battery DC.

- 
- 

- **AC-out-1** The AC output cable can be connected directly to the terminal block 'AC-out'. From left to right: "N" (neutral) - "PE" (earth) - "L" (phase). With its PowerAssist feature the Multi can add up to 6kVA (that is  $6000 / 230 = 26A$ ) to the output during periods of peak power requirement. Together with a maximum input current of 31A this means that the output can supply up to  $31 + 26 = 57 A$ . An earth leakage circuit breaker and a fuse or circuit breaker rated to support the expected load must be included in series with the output, and cable cross-section must be sized accordingly.
- **AC-out-2** A second output is available that disconnects its load in the event of battery-only operation. On these terminals, equipment is connected that may only operate if AC voltage is available on AC-in-1, e.g. an electric boiler or an air conditioner. The load on AC-out-2 is disconnected immediately when the inverter/charger switches to battery operation. After AC power becomes available on AC-in-1, the load on AC-out-2 will be reconnected with a delay of approximately 2 minutes.
- **AC-in** The AC input cable can be connected to the terminal block 'AC-in'. From left to right: "N" (neutral) - "PE" (earth) - "L" (phase) **The AC input must be protected by a fuse or magnetic circuit breaker rated at 32A or less, and cable cross-section must be sized accordingly.** If the input AC supply is rated at a lower value, the fuse or magnetic circuit breaker should be down sized accordingly.

## 4.8. VE.Direct

This can be used to connect a PC/laptop to configure the inverter with a VE.Direct to USB accessory. Can also be used to connect a Victron GlobalLink 520 to allow for remote data monitoring.

Note the VE.Direct port on the Multi RS Solar cannot be used to connect to a GX device, and the VE.Can connection must be used instead.

## 4.9. VE.Can

Used to connect to a GX Device, and/or daily-chain communications to other VE.Can compatible products such as the VE.Can MPPT range.

## 4.10. Bluetooth

Used to connect to the device via VictronConnect for configuration.

Note that this Bluetooth interface is not compatible with VE.Smart Networking (i.e Smart Battery Sense).

## 4.11. User I/O

### 4.11.1. Remote on/off connector

The remote on/off connector has two terminals, the "Remote L" and the "Remote H" terminal.

The Multi RS Solar ships with the remote on/off connector terminals connected to each other via a wire link.

Note that for the remote connector to be operational, the main on/off switch on the Multi RS Solar needs to be switched to "on"

The remote on/off connector has two different operational modes:

#### On/off mode (default):

The default function of the remote on/off connector is to remotely switch the unit on or off.

- The unit will switch on if "Remote L" and the "Remote H" are connected to each other (via a remote switch, relay or the wire link).
- The unit will switch off if "Remote L" and the "Remote H" are not connected to each other and are free floating.
- The unit will switch on if "Remote H" is connected to battery positive (Vcc).
- The unit will switch on if "Remote L" is connected to battery negative (GND).

#### 2-wire BMS mode:

This feature can be enabled via VictronConnect. Go to "battery settings" and then to "Remote mode". (see attached image)

Set the remote mode from "on/off" to "2-wire BMS".

In this mode, the "load", "load disconnect" or "allowed to discharge" signal and the "charger", "charger disconnect" or "allowed to charge" signals from a Victron lithium battery BMS are used to control the unit. They respectively turn the inverter off in case discharge is not allowed, and turn the solar charger off if charging is not allowed by the battery.

- Connect the BMS "load", "load disconnect" or "allowed to discharge" terminal to the Inverter RS Smart "Remote H" terminal.
- Connect the BMS "charger", "charge disconnect" or "allowed to charge" to the unit Inverter RS Smart "Remote L" terminal.

### 4.11.2. Programmable relay

Programmable relay which can be set for general alarm, DC under voltage or genset start/stop function. DC rating: 4A up to 35VDC and 1A up to 70VDC

### 4.11.3. Voltage sense

For compensating possible cable losses during charging, two sense wires can be connected directly to the battery or to the positive and negative distribution points. Use wire with a cross-section of 0,75mm<sup>2</sup>.

During battery charging, the charger will compensate the voltage drop over the DC cables up to a maximum of 1 Volt (i.e. 1V over the positive connection and 1V over the negative connection). If the voltage drop threatens to become larger than 1V, the charging current is limited in such a way that the voltage drop remains limited to 1V.

### 4.11.4. Temperature sensor

For temperature-compensated charging, the temperature sensor (supplied with the unit) can be connected. The sensor is isolated and must be fitted to the negative terminal of the battery. The temperature sensor can also be used for low temperature cut-off when charging lithium batteries (configured in VictronConnect).



#### 4.11.5. Programmable analog/digital input ports

The product is equipped with 2 analog/digital input ports.

The digital inputs are 0-5v, and when an input is pulled to 0v it is registered as 'closed'

These ports can be configured in VictronConnect. For more information search Victron Community.

#### 4.11.6. User I/O terminal diagram

Figure 1.

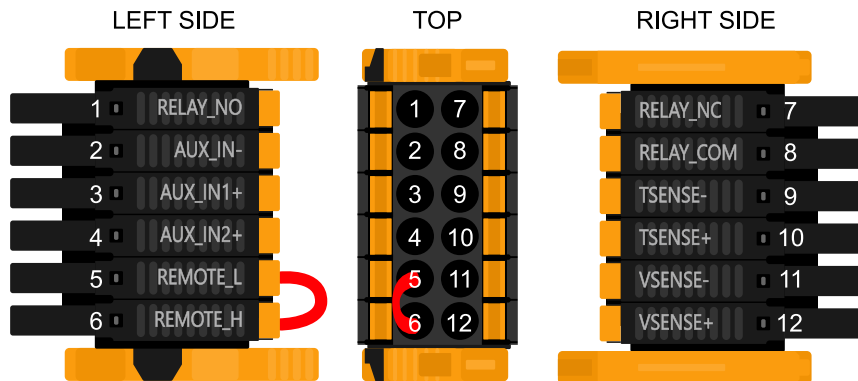

User I/O Connector is located on bottom left side of connection area, diagram shows 3 perspectives. Left Side - Top - Right Side

#### 4.11.7. User I/O functions

Table 3. User I/O Functions - See Installation Section for more details.

Number	Connection	Description
1	Relay_NO	Programmable relay Normally Open connection
2	AUX_IN -	Common negative for programmable auxiliary inputs
3	AUX_IN1+	Programmable auxiliary input 1 positive connection
4	AUX_IN2+	Programmable auxiliary input 2 positive connection
5	REMOTE_L	Remote on/off connector Low
6	REMOTE_H	Remote on/off connector High
7	RELAY_NC	Programmable relay Normally Closed connection
8	RELAY_COM	Programmable relay common negative
9	TSENSE -	Temperature Sensor negative
10	TSENSE +	Temperature Sensor positive
11	VSENSE -	Voltage Sensor negative
12	VSENSE +	Voltage Sensor positive

#### 4.12. Programming with VictronConnect

This guide will help you with the specific elements of VictronConnect that relate to the MPPT Solar Charge Controller.

More general information about the VictronConnect App - how to install it; how to pair it with your device; and how to update firmware, for example - can be found by referring to the overall [VictronConnect manual](#). A list of all VictronConnect compatible devices can be viewed [here](#).

Note: These instructions can apply to different products and configurations, where battery voltage is referred to in these instructions, a 12V battery is used as a reference point. Please multiply the given values by 4 to arrive at settings for an installation configured for the 48V battery system.

### 4.12.1. Settings

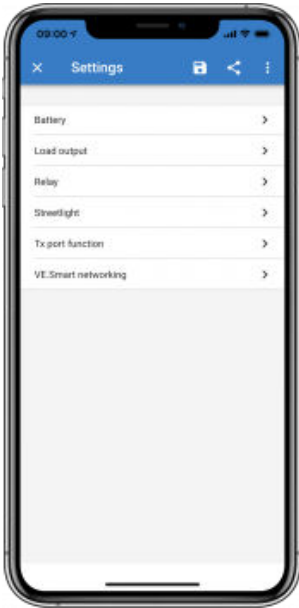

The settings page is accessed by clicking on the Cog icon at the top right of the Home page. The settings page provides access to view or change the settings of the Battery; Load; Streetlight; and Port functions. From this page you can also view Product information such as the Firmware versions installed on the MPPT Solar Charger.

### 4.12.2. Battery settings

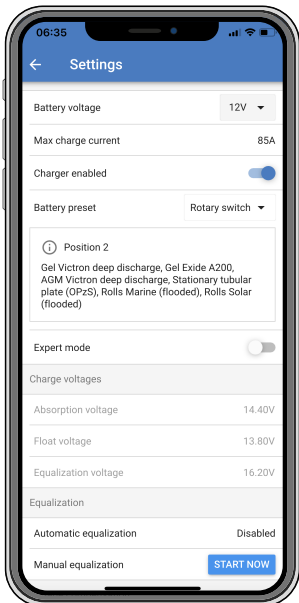

#### Battery voltage

The RS is fixed to 48V, and is only available for 48V systems.

#### Max charge current

Allows the user to set a lower maximum charge current.

#### Charger enabled

Toggling this setting turns the Solar Charger off. The batteries will not be charged. This setting is intended only for use when carrying-out work on the installation.

#### Charger settings - Battery preset

Battery preset allows you to select the battery type; accept factory defaults; or enter your own preset values to be used for the battery charge algorithm. The Absorption voltage, Absorption time, Float voltage, Equalisation voltage and Temperature compensation settings are all configured to a preset value - but can be user-defined.

User-defined presets will be stored in the preset library - in this way installers will not have to define all the values each time they are configuring a new installation.

By selecting *Edit Presets*, or on the Settings screen (with expert mode on or not), custom parameters can be set as follows:

### Absorption voltage

Set the absorption voltage.

### Adaptive absorption time

Select with adaptive absorption time or fixed absorption time will be used. Both are better explained below:

*Fixed absorption time:* The same length of absorption is applied every day (when there is enough solar power) by using the maximum absorption time setting. Be aware that this option can result in overcharging your batteries, especially for lead batteries and system with shallow daily discharges. See your battery manufacturer for recommended settings. *Note:* make sure to disable the tail current setting to make the same absorption time every day. The tail current could end absorption time sooner if the battery current is below the threshold. See more information on the tail current setting section below.

*Adaptive absorption time:* The charge algorithm can use an adaptive absorption time: it automatically adapts to the state of charge in the morning. The maximum duration of the absorption period for the day is determined by the battery voltage as measured just before the solar charger begins operation each morning (12 V battery values used - Multiply Battery voltage by 4 for 48V):

Battery voltage Vb (@start-up)	Multiplier	Maximum absorption times
Vb < 11.9 V	x 1	06:00 hours
> 11.9 V Vb < 12.2 V	x 2/3	04:00 hours
> 12.2 V Vb < 12.6 V	x 1/3	02:00 hours
Vb > 12.6 V	x 2/6	01:00 hours

The multiplier is applied to the maximum absorption time setting and this results in the maximum duration of the absorption period used by the charger. The maximum absorption times shown in the last column of the table are based on the default maximum absorption time setting of 6 hours.

### Maximum absorption time (hh:mm)

Set the absorption time limit. Only available when using a custom charge profile.

Enter the time value in the notation hh:mm, where hours are between 0 and 12; and minutes are between 0 and 59.

### Float voltage

Set the float voltage.

### Re-bulk voltage offset

Set the voltage offset that will be used over the float voltage setting that will determine the threshold that the charge cycle will restart.

E.g.: For a Re-bulk voltage offset of 0.1V and a float voltage setting of 13.8 V, the voltage threshold that will be used to restart the charge cycle will be 13.7 V. In other words, if the battery voltage drops below 13.7 V for one minute, the charge cycle will restart.

### Equalization voltage

Set the equalization voltage.

### Equalization current percentage

Set the percentage of the Max charge current setting that will be used when equalisation is performed.

### Automatic Equalization

Set-up the frequency of the auto equalize function. Available options are between 1 and 250 days:

- 1 = daily
- 2 = every other day
- ...
- 250 = every 250 days

Equalization is typically used to balance the cells in a lead battery, and also to prevent stratification of the electrolyte in flooded batteries. Whether (automatic) equalization is necessary, or not, depends on the type of batteries, and their usage. Consult your battery supplier for guidelines.

When the Automatic equalization cycle has initiated, the charger applies an equalization voltage to the battery as long as the current level stays below the equalization current percentage setting of the bulk current.

Duration of the Automatic equalization cycle

In the case of all VRLA batteries and some flooded batteries (algorithm number 0, 1, 2 and 3) automatic equalization ends when the voltage limit (maxV) has been reached, or after a period equal to (absorption time/8) - whichever comes first.

For all tubular plate batteries (algorithm numbers 4, 5 & 6); and also for the user-defined battery type, automatic equalization will end after a period equal to (absorption time/2).

For the Lithium battery type (algorithm number 7), equalization is not available.

When an automatic equalization cycle is not completed in one day, it will not resume the next day. The next equalization session will take place according to the interval set in the 'Auto Equalization' option.

The default battery type is a VRLA battery and any user-defined battery will behave as a tubular plate battery with regard to equalization.

**Equalisation stop mode**

Set how the equalisation will end. There are two possibilities, first is if the battery voltage reaches the equalisation voltage and the second is on fixed time, where the maximum equalisation duration is used.

**Maximum equalisation duration**

Set the maximum time that the equalisation phase will last.

**Tail current**

Set the current threshold that will be used to finish absorption phase before the maximum absorption time expires. When the battery current gets below the tail current for one minute, the absorption phase will end. This setting can be disabled by setting it to zero.

**Temperature compensation**

Many types of battery require a lower charge voltage in warm operating conditions, and a higher charge voltage in cold operating conditions.

The configured coefficient is in mV per degree Celsius for the whole battery bank, not per cell. The base temperature for the compensation is 25°C (77°F), as shown in the chart below.

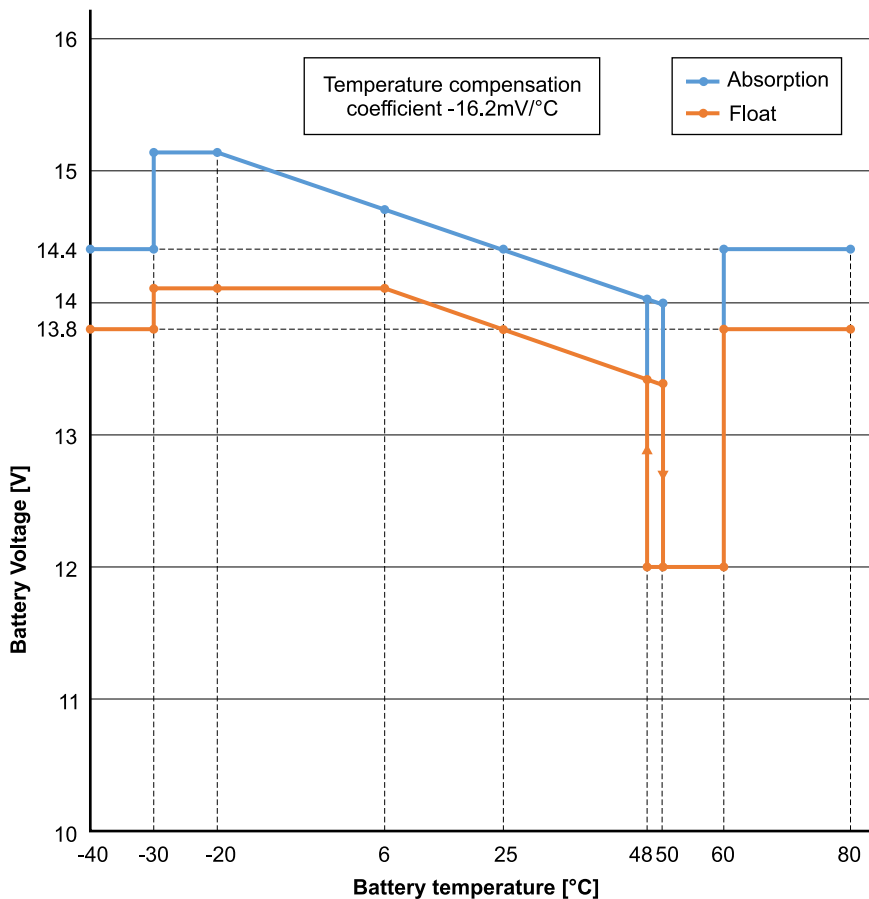

With a temperature sensor installed to the User I/O connection block; the actual battery temperature will be used for compensation; throughout the day.

#### **Low temperature cut-off**

This setting can be used to disable charging at low temperatures as required by Lithium batteries.

For Lithium Iron Phosphate batteries this setting is preset at 5 degrees Celsius, for the other battery types it is disabled. When creating a user defined battery the cut-off temperature level can be adjusted manually.

#### **Manual Equalization - Start now**

Selecting 'Start now' on 'Manual equalisation' allows manual initiation of an Equalization cycle. To allow the charger to equalize the battery properly use the manual equalize option only during absorption and float periods, and when there is sufficient sunlight. Current and voltage limits are identical to the automatic equalize function. The duration of the equalisation cycle is limited to a maximum of 1 hour when triggered manually. Manual equalization can be stopped at any time by selecting 'Stop Equalize'.

### **4.13. Connecting to AC PV inverters**

The Multi includes a built in AC PV inverter detection system. When there is a feedback of AC PV (a surplus) from the AC-out connection port, the Multi will automatically enable an AC output frequency adjustment.

While no further configuration is required, it is important that the AC PV inverter is configured correctly to respond to the frequency adjustment by reducing its output.

Note the 1:1 rule of AC PV inverter size to Multi size, and minimum battery sizing applies. More information about these limitations are available in the [AC Coupling manual](#), and this document is required reading if using an AC PV inverter.

The frequency adjustment range is not configurable, and includes a built in safety margin. Once the absorption voltage is reached, the frequency will increase. So it is still essential to include a DC PV component in the system for complete battery charging (i.e. float stage).

It may be possible to adjust the power output response to various frequencies on your AC PV inverter.

The default configuration has been tested and works reliably with the Fronius MG50/60 grid code configuration.

## 5. Operation

### 5.1. Device display

The Multi RS Solar has an LCD screen that displays operational information.

#### Inverter:

Inverter state, Power output, Frequency and AC Voltage

```
Inverter:      ***
 410A 50.0Hz 230V
- Inverting -
```

```
AC input:     ***
-5000W 50.0Hz 230V
ACIN1 relay closed
```

#### Battery:





Battery Power (charging shows positive number, discharging shows negative number), Current, DC voltage, Temperature (\*), State-of-charge (\*) and Time-to-go (\*). Battery state (e.g. discharging, bulk, absorption, float, etc).

```
Battery:      ***
 1748W 54.12V 32A
 26°C 98%
- Bulk -
```

(\*) These items are only visible if the data is available.

```
Solar:        ***
 1812W 178.9V 10.1A
Today 0.29 kWh
Total 0.3 kWh
```

```
AC Solar:     ***
 2500W 50.0Hz
Today 9.89 kWh
Total 551.3 kWh
```

	Communicating on any interface (e.g., Bluetooth, VE.Can, etc.)
	Bluetooth Enabled, Icon colour changes when connected
	(Blinking) Error or Warning
	Inverter Active



Battery, fill corresponds with voltage, blinks when empty

## 5.2. History - Thirty-day graphic



(The fragmented square icon (top left) allows you to toggle between 'portrait' and 'landscape' screen presentations.)

A summary of activity for the last 30 days is presented graphically. Swipe the bar left or right to show any of the previous 30 days.

The daily log shows:

- **Yield:** The energy converted for that day.
- **P max:** The maximum power recorded during the day.
- **V max:** The highest voltage from the PV array during the day.

Clicking on any day/bar in the graph will expand the information to show charge-status times - both as hrs/m; and also as a percentage of the 'charge' day. This graphic provides an at-a-glance representation of how much time your charger is spending in each of three modes: Bulk / Absorption / Float.

Tip! You can use the charge times to see if the PV array is properly sized for your requirements. A system which never reaches 'Float' may need more panels; or perhaps the load could be reduced?

It is possible to export the history as a comma separated file (.csv) by clicking the three connected dots at the top right of the history screen:

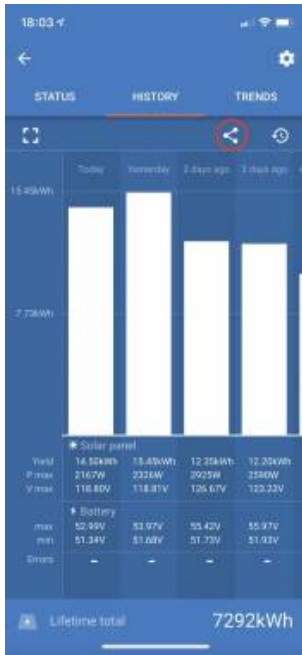

This is an example of the exported data for 3 of 30 days:

Days ago	Date	Yield(MWh)	Consumption(MWh)	Max. PV power(W)	Max. PV voltage(V)	Min. battery voltage(V)	Max. battery voltage(V)	Time in bulk(m)	Time in absorption(m)	Time in float(m)	Last error	2nd last error	3rd last error	4th last error
0 3/22	5520	190	1159.13	86.93	50.06	57.96	345	0	0	0	0	0	0	0
1 2/22	7280	50	1160.17	87.01	49.61	58.01	455	120	71	0	0	0	0	0
2 1/22	6400	130	1167.8	87.58	50.12	58.39	400	120	91	2	0	0	0	0
3 28/22	3950	160	1161.42	87.11	49.41	58.07	247	120	85	0	0	0	0	0
4 27/22	6870	270	1156.12	86.71	50.34	57.81	430	120	65	0	0	0	0	0
5 26/22	5450	50	1169.5	87.71	49.56	58.47	341	120	74	0	0	0	0	0
6 25/22	7170	50	1159.24	86.94	49.89	57.96	448	120	67	0	0	0	0	0
7 24/22	6890	290	1154.23	86.57	49.85	57.71	431	120	81	0	0	0	0	0
8 23/22	6870	110	1155.14	86.64	49.54	57.76	429	120	79	0	0	0	0	0
9 22/22	4140	70	1158.62	86.9	50.23	57.93	259	120	65	0	0	0	0	0
10 21/22	7070	220	1154.57	86.59	50.05	57.73	442	120	102	0	0	0	0	0
11 20/22	5980	240	1166.48	87.49	49.79	58.32	374	120	114	0	0	0	0	0
12 19/22	6630	200	1162.79	87.21	49.93	58.14	414	120	63	0	0	0	0	0
13 18/22	6470	220	1154.59	86.59	50	57.73	405	120	86	0	0	0	0	0
14 17/22	4660	50	1165.6	87.42	49.83	58.28	291	120	91	0	0	0	0	0
15 16/22	4710	10	1164.31	87.32	50.36	58.22	294	120	66	0	0	0	0	0
16 15/22	5930	180	1171.3	87.85	50.19	58.56	371	120	72	0	0	0	0	0
17 14/22	5270	70	1161.25	87.09	50.12	58.06	329	120	118	0	0	0	0	0
18 13/22	6000	90	1170.66	87.8	50.03	58.53	375	120	69	0	0	0	0	0
19 12/22	5460	140	1163.38	87.25	49.54	58.17	341	120	60	0	0	0	0	0
20 11/22	6530	230	1155.58	86.67	49.69	57.78	408	120	71	0	0	0	0	0
21 10/22	4780	190	1167.97	87.6	49.53	58.4	299	120	94	0	0	0	0	0
22 9/22	6750	280	1156.98	86.77	50	57.85	422	120	63	0	0	0	0	0
23 8/22	6350	220	1159.76	86.98	50.07	57.99	397	120	86	0	0	0	0	0
24 7/22	6470	290	1162.95	87.22	50.2	58.15	405	120	109	0	0	0	0	0
25 6/22	7280	270	1168.69	87.65	50.02	58.43	455	120	109	0	0	0	0	0
26 5/22	4770	270	1166.14	87.46	50.06	58.31	298	120	107	0	0	0	0	0
27 4/22	6800	140	1157.28	86.8	49.63	57.86	425	120	118	0	0	0	0	0
28 3/22	4430	270	1169.64	87.72	50.33	58.48	277	120	96	0	0	0	0	0
29 2/22	6780	130	1152.93	86.47	50.31	57.65	424	120	93	0	0	0	0	0

### Battery Voltage

The first figure shows the maximum battery voltage for the day ...the figure below is the minimum battery voltage.

### Errors

Shows the number of errors (if any) for the day, to see the error codes click on the orange point. See [MPPT Solar Charger Error Codes](#). (You may need to slide the display on your device up to see the errors.)

### Total

This shows the total energy converted by the installation and is not re-settable.

### Since Cleared

This shows how much energy has been converted by the installation since the last reset.

## 5.3. Protections and automatic restarts

### 5.3.1. Overload

Some loads like motors or pumps draw large inrush currents during start-up. In such circumstances, it is possible that the start-up current exceeds the over current limit of the inverter. In this case the output voltage will quickly decrease to limit the output current of the inverter. If the over current limit is continuously exceeded, the inverter will shut down for 30 seconds and then automatically restart. After three restarts followed by overload within 30 seconds of restarting, the inverter will shut down and remain off. To restart normal operation, disconnect the load, Switch Off the inverter, then switch it On.



### 5.3.2. Low battery voltage thresholds (adjustable in VictronConnect)

The inverter will shut down when the DC input voltage drops below the low battery shutdown level. After a minimum shutdown time of 30 seconds, the inverter will restart if the voltage has risen above the low battery restart level.

After three shut down and restarts, followed by a low battery shutdown within 30 seconds of restarting, the inverter will shut down and stop retrying based on the low battery restart level. To override this and restart the inverter, switch it Off, and then On, and limit loads to enable recharging of the battery with solar energy.

See the Technical Data table for default low battery shut down, restart and charge detect levels. They can be adjusted with VictronConnect (computer or app).

Additionally another external MPPT or battery charger can also be used to recharge the battery to reach the Restart Voltage or Charge Detect voltage level. !!! If using the allow to charge signal functionality, it must remain above the minimum voltage, so if the battery is completely dead it will not allow charging to start. In this case, you can temporarily disable this function in VictronConnect to allow charging to resume, then enable it again.

See the Technical Data table for default low battery shut down and restart levels. They can be changed with VictronConnect (computer or app). Alternatively Dynamic Cut-off can be implemented, see <https://www.victronenergy.com/live/ve.direct:phoenix-inverters-dynamic-cutoff>

### 5.3.3. High battery voltage

Reduce DC input voltage and/or check for a faulty battery- or solar-charger in the system. After shutting down due to a high battery voltage, the unit will first wait 30 seconds and then retry operation as soon as the battery voltage has dropped to acceptable level.

### 5.3.4. High temperature

A high ambient temperature or enduring high load may result in shut down to over temperature. The inverter will restart after 30 seconds. The inverter will continue to try and resume operation, and will not stay off after multiple retries. Reduce load and/or move inverter to better ventilated area.

## 6. Troubleshooting Guide - MPPT

### 6.1. Troubleshooting and Support

Consult this chapter in case of unexpected behaviour or if you suspect a product fault.

The correct troubleshooting and support process is to first consult the common issues as described in this chapter.

Should this fail to resolve the issue, contact the point of purchase for technical support. If the point of purchase is unknown, refer to the [Victron Energy Support webpage](#).

### 6.2. The controller is not operational

For the controller to be operational it needs to be powered-up.

To power up the unit, make sure there is voltage on the battery terminals, and then turn on the switch located on the underside of the unit on the left hand side.

Once the controller is powered up, VictronConnect can be used to: check controller status, to check errors, to update firmware and/or to make or change settings.

If the unit does not power up use this chapter to check the possible reasons why the controller is not operational.

#### 6.2.1. Visual check

Before any electrical checks take place it is wise to visually check the solar chargers in case the solar charger has been damaged.

- Check for mechanical damage, burn marks or water damage. This damage is not normally covered by warranty.
- Inspect the battery terminals and the PV terminals. If there are burn marks on the terminals or if the cables or connectors are molten refer to paragraph: "PV cable connection burned or melted". In most cases this damage is not covered by warranty.
- Check if there are burn or melting marks on the housing or if there is a burn smell (all very unlikely). If this is the case, lodge a support request with your Victron dealer or distributor. Depending on the cause, this damage might not covered by warranty.

#### 6.2.2. Battery supply check

Check if the solar charger is receiving battery supply.

The normal way to check the battery voltage is via the VictronConnect app, a display or a GX device. However, in this case the controller is not operational so the battery voltage needs to be measured manually. Measure the battery voltage at the solar chargers battery terminals using a multi meter.

The reason to measure the battery voltage at the terminals of the solar charger is to rule out potential issues with the wiring, fuses and/or circuit breakers located in the path between the battery and the controller.

Depending on the result of the measurement do the following:

Battery voltage	Operational state	Action to take
No voltage	Not powered	Restore the battery supply. See chapter: "battery supply issue"
Correct voltage	Not powered	There might be a fault with the controller. Contact your Victron dealer or distributor.
Correct Voltage	Powered, but not charging	Connect PV supply and check if battery charging starts. If charging does not start, see chapter: "Batteries are not charged".

### 6.3. Batteries are not charged

This chapter lists all possible reasons why the solar charger does not charge the batteries, and the steps you can take to remedy the situation.

There are a number of reasons why the solar charger might not charge the batteries.

For example:

- Issues with the battery, PV panels or system wiring.
- Incorrect settings.
- The solar charger is externally controlled.
- Natural battery behaviour.

In some of these cases the VictronConnect app will show, at the bottom of the status screen, a clickable link with the text “why is the charger off”. If the link is clicked, an explanation will appear as to why the charger is off.

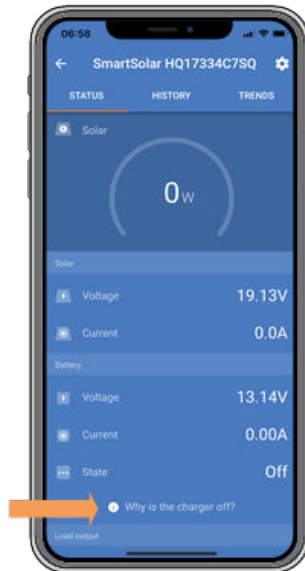

*VictronConnect – link to “why is the charger off”*

### 6.3.1. Battery supply issue

For the solar charger to be fully operational as a battery charger, it needs to be connected to a battery.

Although it might look like the solar charger is connected to the battery, it is very well possible that the controller is not receiving the battery supply, there is no voltage at the battery terminals of the solar charger.

Possible causes can be:

- Loose or missing battery cables.
- Loose cable connections, or badly crimped cable terminals.
- A blown (or missing) fuse in the battery supply cable.
- Open (or faulty) circuit breaker in the battery supply cable.
- Missing or incorrectly wired battery cables.

#### Battery voltage check

1. Use the VictronConnect app, a connected display or a GX device to find out what the battery terminal voltage of the controller is. If this is unavailable use a multi meter to measure the battery voltage at the terminals of the controller.
2. Use a multi meter to measure the voltage at the battery terminals.

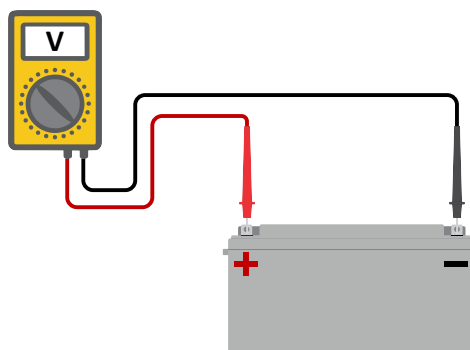

3. Compare the two voltages.
4. If the battery voltage and the controller voltage are not the same, then investigate why this is. Follow the path from the controller to the battery to investigate what could be the cause.

### Battery supply check

1. Check and verify that all cabling is connected correctly, and that no wiring mistakes have been made.
2. Check if all cable connections are tight while taking maximum torque levels into consideration.
3. Check if all cable lugs or cable terminals have been crimped correctly.
4. Check fuses and/or circuit breakers.



If a blown fuse is found, first ensure that the battery polarity has been correctly wired before replacing the fuse. See next paragraph for more information on reverse battery polarity.

### 6.3.2. Reverse battery polarity

Reverse polarity is when the positive and the negative battery cable have been accidentally swapped. The battery negative has been connected to the positive solar charger terminal and the battery positive has been connected to the negative solar charger terminal.



Be aware that a red cable or positive labelled cable might not necessarily mean that the cable is indeed a positive cable. A wiring or labelling mistake could have been made during installation of the solar charger.

The solar charger is not protected against reverse battery polarity and any damage caused by this is not covered under warranty.



Always verify the battery polarity before reconnecting the battery wires to the solar charger.

### 6.3.3. PV voltage too low

The solar charger will commence charging when the PV voltage is a minimum of 120V. Once charging has commenced, the PV voltage must remain higher than 80V for charging to continue.

#### Check the PV and battery voltage



**WARNING:** Depending on the solar charge controller model, the PV voltage can be up to 450Vdc. Voltages above 50V are generally considered to be dangerous. Check your local electrical safety regulations as to the exact regulations. Dangerous voltages can only be handled by a qualified technician.

1. Use the VictronConnect app, a solar charger display or a GX device to check the battery voltage and PV voltage.
2. In case the above step is not possible, measure the battery and PV voltages at the solar charger terminals using a multi meter instead.
3. Compare both voltages. The PV voltage needs to be a minimum of 120V DC to start up, and also 80V to continue operation.

#### Causes of zero or low PV voltage:

Not enough solar irradiance into the solar panels:

- Night.
- Cloud cover or bad weather.
- Shading – see this [shading blog story](#) for more information.
- Dirty panels.
- Seasonal differences.
- Wrong orientation and/or inclination.

Problems with a panel or panel wiring:

- Mechanical or electrical issue with an individual panel (or multiple panels).

- Wiring problems.
- Blown fuses.
- Open or faulty circuit breakers.
- Splitters or combiners issues, or these are used in an incorrect way.

PV array design issues:

- Solar array wiring configuration mistake - not enough panels in a series string.

Reverse PV polarity:

- The positive and negative have been swapped when connected to the controller, read next paragraph: “Reverse PV polarity”.

### 6.3.4. Reverse PV polarity

As long as the unit is installed within the published specifications, the PV input is protected internally against PV reverse polarity.

In case of reverse PV voltage, the solar charger will not indicate an error. The only way to tell is by the following signs:

- The controller is not charging the batteries.
- The controller is getting hot.
- The PV voltage is very low or zero Volt.

If this is the case check for reverse polarity using a multimeter by ensuring that the positive PV cable is connected to the positive PV terminal, and the negative cable is connected to the negative terminal.

### 6.3.5. PV voltage too high

The PV voltage should never exceed the maximum rated PV voltage of the solar charger. The maximum PV voltage rating is printed on the front or on the side of the housing of the controller, and in the product specification sheets.

The solar charger stops charging if the PV voltage exceeds the maximum rated PV voltage. At the same time, it will display an overvoltage error #33, and will fast blink its absorption and float LED.

Charging will not recommence until the PV voltage has dropped 5V below the rated maximum voltage.

When investigating a high voltage issue, also look at the history of the VictronConnect app, solar charger display or GX device. Check the highest PV voltage for each day (Vmax) and also look for past overvoltage warnings.

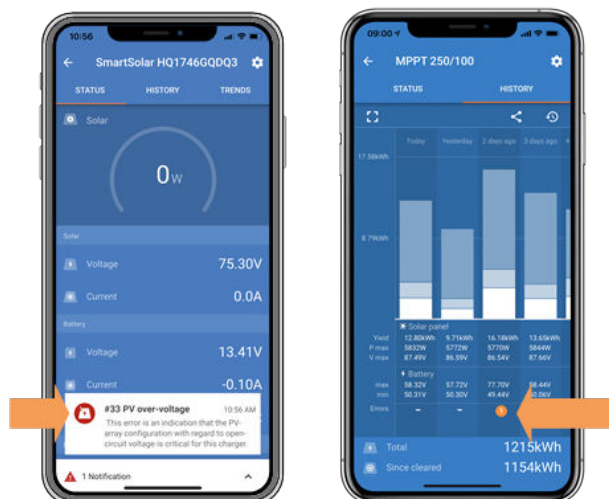

*VictronConnect: screenshot of an Error #33 and a screenshot of the history indicating an error*

Check the open circuit voltage (Voc) rating of the PV array. Ensure that it is less than the maximum rated voltage of the solar charger. Use the MPPT sizing calculator on the [solar charger product page](#). In case the PV array is located in cold climates or if the night temperature drops close to or below 10°C the PV array can output more than its rated Voc. As a rule of thumb, keep an additional 10% safety margin.

An overvoltage event can damage the solar charger, depending on how much the maximum PV voltage was exceeded. This damage is not covered by warranty.

### 6.3.6. Battery full

Once the battery is full the solar charger will stop charging or will greatly reduce the charge current.

This is especially the case when at the same time the DC loads in the system are not consuming any power from the battery.

To find out what the state of charge (SoC) of the battery is, check the battery monitor (if present), or alternatively check what charge stage the controller is in. Also observe that the solar cycle is (briefly) progressing through these charge stages at the beginning of the daily charge cycle:

- Bulk stage: 0-80% SoC
- Absorption stage 80-100% SoC
- Float or storage stage: 100% SoC.

Be aware that it can also be possible that the solar charger thinks the battery is full, while in reality the battery is not full. This can occur when the charge voltages have been set too low, causing the solar charger to prematurely switch to the absorption or float stage.

### 6.3.7. The charger is disabled

Check the VictronConnect app to make sure the charger has been enabled.



*VictronConnect charger enable/disable setting*

### 6.3.8. Controlled by an external device

The solar charger can be controlled by an external device. The external device can stop or reduce the charge current to the battery.

There are different types of external control:

- Managed batteries or an inverter/charger with an external control system can control the solar charger via a GX device. The battery dictates if charging is allowed, and when charging is allowed, what charge voltage and currents are used. If external control is active this will be displayed in the VictronConnect App and also on the GX device.

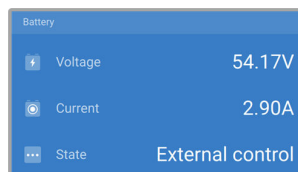

- The BMS of a managed battery can directly turn the charger on or off via a remote L/H connections. If the charge settings are correctly set and if all battery cells are balanced, the BMS should never disallow charging. The BMS will disallow charging when the cell voltage of one (or more) battery cells is too high or when the low temperature cut off is enabled and the battery temperature has dropped below the temperature threshold.
- An external device or a switch can turn the solar charger off via the remote on/off terminal. For more info see [???](#).

## 6.4. Batteries are undercharged

This chapter deals with possible reasons why the solar charger is not sufficiently charging the batteries and the steps you can take to check or remedy the situation.

Some signs of undercharged batteries:

- The batteries take too long to charge.
- The batteries are not fully charged at the end of the day.
- The charge current from the solar charger is less than expected.

### 6.4.1. The battery is almost full

The solar charger will reduce its charge current when the battery is almost full.

If the state of charge of the battery is unknown, and the current is reducing while the sun is still shining, it can mistakenly be interpreted as the solar charger being faulty.

The first current reduction takes place at the end of the absorption stage, when the battery is approximately 80% charged.

The current will continue to reduce during the float stage, when the battery is approximately 80 and 100% charged.

The float stage starts when the batteries are 100% full. During the float stage the charge current is very low.

To find out what the state of charge (SoC) of the battery is, check the battery monitor (if present), or alternatively check the charge stage the solar charger is in.

- Bulk: 0-80% SoC
- Absorption 80-100% SoC
- Float or storage: 100% SoC

### 6.4.2. Too much DC load

The solar charger does not only charge the batteries, it also provides power for the system's loads.

The battery will only be charged when the power available from the PV panels exceeds the power being drawn by the loads in the system, like lights, fridge, inverter, and so on.

If the system battery monitor is correctly installed and configured you can see how much current is going in (or out) of the battery and the solar charger will tell you how much current the solar array is generating.

A positive sign alongside the current reading means that current is flowing in to the battery, while a negative sign means that current is being drawn from the battery.

### 6.4.3. Insufficient solar

Check if the solar charger reaches the float charge stage each day.

To investigate look at the history tab in the VictronConnect app. The histogram displays how long the batteries have been charged in the Bulk, Absorption and Float stage each day, for the last 30 days. If you click on one of the histogram columns you will see a breakdown of the charge stages.

You can use the charge times to see if the PV array is properly sized for your requirements. A system which never reaches the float stage could have the following issues:

- Not enough solar panels
- Too much load
- A problem with the array causing it to have a reduced power output.
- For more potential reasons see paragraph: "PV power or yield less than expected"

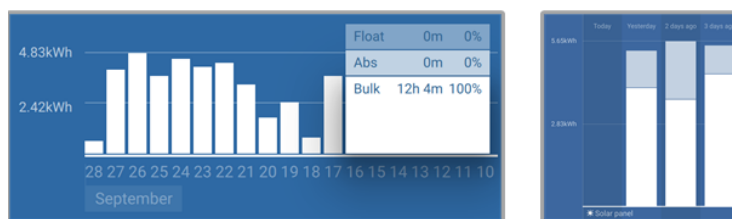

System spending all its time in bulk with breakdown of charge stages - System in bulk and absorption

### 6.4.4. Battery charge current too low

Check the "Max charge current" setting in the VictronConnect app or via the display.

If the "Max charge current" has been set too low, it will take longer to charge the batteries and/or the batteries will not be fully charged at the end of day.

### 6.4.5. Battery charge voltages are too low

If the battery voltages have been set too low the batteries will not receive a full charge.

Check if the battery charge voltages (absorption and float) are set correctly. Consult the battery manufacturers information for the correct charge voltages.

### 6.4.6. Battery cable voltage drop

If there is a voltage drop over the battery cables, the solar charger will output the correct voltage, but the batteries will receive a lower voltage. Battery charging will take longer, and this can potentially lead to undercharged batteries.

A voltage difference has the effect that the battery will be charged with voltages that are too low to. It will take longer to charge the batteries because the charge voltage is too low and there is a loss of charge power. The lost power is caused by heat dissipated over the battery cables.

The voltage drop is caused by the following:

- Battery cables with insufficient cross-sectional area
- Badly crimped cable lugs or terminals
- Loose terminal connections
- Bad or loose fuse(s)

For more information on cabling issues and voltage drop see the [Wiring unlimited book](#)

### Battery cable voltage drop check

This check can only be performed if the solar charger is in the bulk charge stage and is charging with full current.

1. Measure the voltage on the battery terminals of the solar charger using the VictronConnect app or a multi meter.
2. Measure the battery voltage on the terminals of the battery using a multi meter.

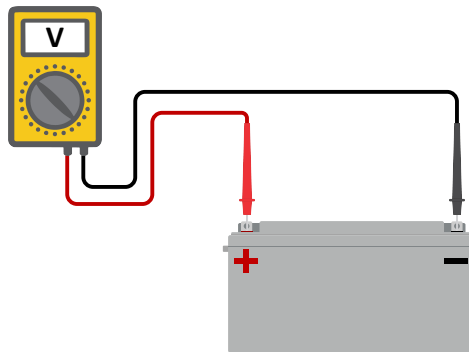

3. Compare the two voltages to see if there is a voltage difference.

### 6.4.7. Wrong temperature compensation setting

If the temperature compensation coefficient is set incorrectly, the batteries can be undercharged or be overcharged. The temperature compensation can be set via VictronConnect or via a display.

To find out the correct temperature compensation coefficient setting for your battery, refer to the battery documentation. When in doubt use the default value of  $-64.80\text{mV}/^{\circ}\text{C}$  for lead acid batteries and disable the temperature compensation setting for lithium batteries.

## 6.5. Batteries are overcharged



Batteries that are being overcharged are very dangerous! There is a risk of battery explosion, fire or acid leakage. Do not smoke, create sparks or have open flames in the same room as where the batteries are located.



Overcharging batteries will cause battery damage and can be caused by:

- Incorrect charge voltage settings.
- Battery voltage setting too high.
- Applying equalization while the battery is not suitable for equalization.
- High current and undersized batteries.
- Battery faults.
- Too high current, while the battery is not accepting charge anymore because of aging or prior mistreatment.



### 6.5.1. Battery charge voltages too high

If the battery charge voltages are set too high this will cause the batteries to overcharge.

Check if all the battery charge voltages (absorption and float) are set correctly.

The charge voltages have to match the recommended voltages as stated in the battery manufacturers documentation.

### 6.5.2. Battery unable to deal with equalization

During equalization the battery charge voltage will be quite high and if the battery is unsuitable to be equalized, the battery will be overcharged.

Not all batteries can be charged with equalization voltages. Check with the battery manufacturer if the battery you are using needs a periodic equalizing charge.

Generally speaking, sealed batteries and lithium batteries cannot be equalized.

### 6.5.3. Battery old or faulty

A battery that is at the end of its service life or has been damaged by incorrect use, can be prone to being overcharged.

A battery contains a number of cells that are connected in series. When a battery is old or has been damaged, a likely scenario is that one of these cells is not operational anymore.

When the faulty battery is charged, the damaged cell will not accept charge and the remaining cells will receive the broken cell's charge voltage and thus will be overcharged.

To fix this, replace the battery. In case of multiple battery system replace the whole battery bank. It is not recommended to mix batteries of different ages in one battery bank.

It is hard to tell what has exactly happened to a battery during its lifetime. The solar charger will keep 30 day of battery voltage history. If the system also contains a battery monitor, or if the system is connected to VRM, the battery voltages and the cycle history of the battery can be accessed This will give a complete picture of the battery history and it can be determined if the battery is near the end of its service life or has been abused.

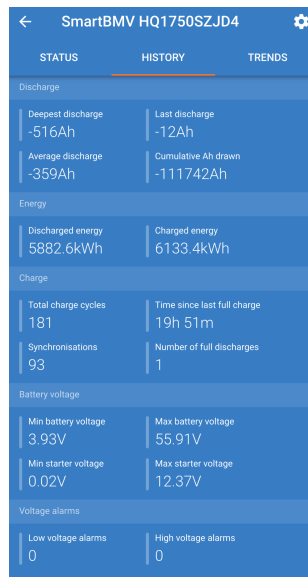

*VictronConnect app showing BMV battery monitor history*

#### To check if the battery is close to its cycle life:

1. Find out how many charge and discharge cycles the battery has been subjected to. Battery lifetime correlates to the number of cycles.
2. Check how deep the battery has been discharge on average. A battery will last for less cycles if deeply discharged, compared to more cycles if discharged less deep.
3. Refer to the battery data sheet to find out how many cycles at what average discharge the battery is capable of. Compare this with the battery history and determine if the battery is near the end of its service live.

**To check if the battery has been misused:**

1. Check if the battery has been totally discharged at all. Total and very deep discharge will damage a battery. Check the battery monitor setting history on the VRM portal. Look for the deepest discharge, the lowest battery voltage and the number of full discharges.
2. Check if the battery has been charged with a too high voltage. Very high charge voltage will damage the battery. Check the maximum battery voltage and the high voltage alarms in the battery monitor. Check if the measured maximum voltage has exceeded the battery manufacturer recommendations.

## 6.6. Solar issues

This chapter deals with the remaining potential solar issues that were not already discussed in the earlier chapters.

### 6.6.1. PV reverse current too high

Overcurrent does not necessarily damage the solar charger, but it will cause damage if the array produces too much current while, at the same time, the array has been connected in reverse polarity to the solar charger. Damage due to overcurrent is not covered under warranty.

Refer to the solar chargers technical specifications for the maximum PV short circuit power current rating.

### 6.6.2. PV yield less than expected

Check the solar charger history in the VictronConnect app. Check the total maximum power (Pmax) for each day. Does this match the array power?

To find the potential solar yield per day for a specific PV array size in a specific geographical location, use the MPPT sizing calculator on the [solar charge controller product page](#).

These are some of the reasons why the array is generating less power than expected:

- Low sun angle, seasonal differences or morning/evening.
- Cloud cover or bad weather.
- Shading from trees or buildings.
- Dirty panels.
- Incorrect orientation and/or inclination.
- Broken or faulty solar panel(s).
- Issues with wiring, fuses, circuit breakers, wiring voltage drop.
- Bad splitters or combiners, or these are used in an incorrect way.
- Part of the PV array not working.
- PV array design issues.
- Solar array configuration mistakes.
- The batteries are too small, or getting older, and have a reduced capacity.

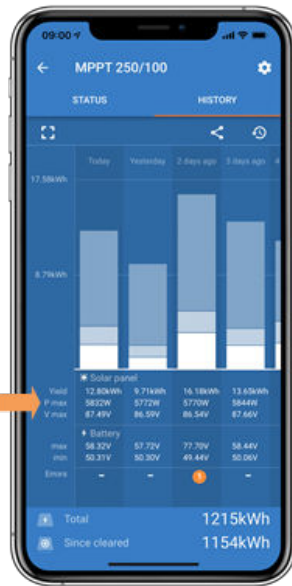

VictronConnect history Pmax

### 6.6.3. Full rated output not reached

There are a few reasons why the solar charger is not reaching its full rated output.

Some of these reasons have already been explained in the the chapter: “The batteries take too long to charge, are undercharged or charge current less than expected”. Some additional reasons are explained in this paragraph.

#### PV array too small

If the PV array power rating is less than the solar charger nominal power rating, the solar charger cannot output more power than the connected solar array can provide.

#### Temperature above 40°C

When the solar charger heats up, eventually the output current will derate. When the current is reduced naturally the output power will reduce as well.

The controller is operational up to 60°C, with a full rated output up to 40°C.

In case the solar charger heats up quicker than expected, pay attention to the way it has been mounted. Mount it in such a way that the generated heat can dissipate.

Ideally mount the solar charger on a vertical surface with the terminals facing downwards.

If the solar charger is located in a closed enclosure, such as a cabinet, make sure that cold air can enter and hot air can leave the enclosure. Mount vents in the enclosure.

For very hot environments consider mechanical air extraction or provide air conditioning.

### 6.6.4. Mixed PV panel types

It is not recommended to connect a mix of different PV panel types to the same solar charger.

Only use solar panels that are the same brand, type and model.

### 6.6.5. MC4 connectors wrongly connected

For a detailed explanation on how to connect MC4 connectors, MC4 splitters and MC4 combiners, see the [Wiring unlimited book](#), chapter 4.10: “Solar panels”.

### 6.6.6. PV connections burned or melted

Burned or melted PV cables or connections are generally not covered under warranty. In most case this is due to any of the following reasons:

#### Solar cable

- Cables with rigid core wire or rigid strands used.
- Cables where the core wire has been soldered.

- Cable too thin - remember that the current will be higher when the PV voltage is lower. For more information on cable thickness see the [Wiring Unlimited book](#).

#### MC4 terminals

- Current has exceeded 30A per connector pair.
- Incorrectly crimped MC4 connectors.
- Bad quality MC4 connectors used

### 6.6.7. Optimisers cannot be used

Do not use solar panels with optimisers together with the solar charger.

Nearly all optimisers contain an MPPT or other tracking mechanisms and this interferes with the MPPT algorithm in the solar charger.

### 6.6.8. Ground current

The system should not have a current flowing to ground under normal operation.

If a ground current is detected, first investigate all the equipment connected to that system and check for ground faults.

Next, check how many connections to ground the system has. There should only be a single point in the system connected to ground. This should be at the battery.

For more information on system grounding, see chapter 7.7: "System grounding" in the [Wiring Unlimited book](#).

The Multi RS Solar connection between PV DC and battery DC is fully galvanically isolated.

The connection between PV DC and AC output is not isolated.

## 6.7. Communication issues

This chapter describes issues that might arise when the solar charger is connected to the VictronConnect app, other Victron devices or third-party devices.

### 6.7.1. VictronConnect issues



For a full troubleshooting guide on the VictronConnect app see the [VictronConnect manual](#).

### 6.7.2. Bluetooth issues

Please note that it is highly unlikely that the Bluetooth interface is faulty. The problem is most likely caused by something else. Use this chapter to quickly rule out some of the common causes of Bluetooth issues.

For a full troubleshooting guide see the [VictronConnect manual](#).

•

- **Check if Bluetooth is enabled**

It is possible to enable/disable Bluetooth in the product settings. To re-enable:

Connect to the solar charger via the VE.Direct port.

Navigate to the controller settings and then to "product info".

Re-enable Bluetooth.

- **Check if the controller is powered-up**

Bluetooth is active as soon as the solar charger is powered-up.

- **Check that Bluetooth is in range**

In open space the maximum Bluetooth distance is about 20 meters. In a build-up area, inside a house, a shed, a vehicle or a boat this distance can be a lot less.

- **The Windows VictronConnect app does not support Bluetooth**

The Windows version of the VictronConnect app does not support Bluetooth. Use an Android, iOS or macOS device instead. Or alternatively connect using a [VE.Direct to USB interface](#).

- **The controller is missing in the VictronConnect device list**

Some steps to try to resolve this issue are:

Press the orange refresh button at the bottom of the VictronConnect device list and check if the solar charger is now listed. Only one phone or tablet can be connected to the solar charger at any given time. Make sure no other devices are connected and try again.

Try to connect to another Victron product, does this work? If that also does not work, there probably is an issue with the phone or tablet.

Rule out any issues with the phone or the VictronConnect app by using another phone or tablet and try again.

If still unresolved, refer to the [VictronConnect manual](#).

- **PIN code lost**

If you have lost the PIN code, you will need to reset the PIN code to its default PIN code. This is done in the VictronConnect app:

Navigate to the device list of the VictronConnect app.

Enter the solar charger's unique PUK code as printed on its product information sticker.

Click on the option symbol next to the solar charger listing.

A new window will open which allows you to reset the PIN code back to its default: 000000.

- **How to communicate without Bluetooth**

In case Bluetooth is not functional, turned off or unavailable, VictronConnect can communicate via the unit's VE.Direct port. Or, if the unit is connected to a GX device, VictronConnect can communicate via VRM. For more information see paragraph: "The different ways to connect with VictronConnect".

### 6.7.3. VE.Direct port communication issues

These are not common and if this occurs it is probably due to one of these issues listed in this paragraph.

**Physical cable connector or data port issues** Try a different VE.Direct cable and see if the unit will now communicate. Is the connector inserted properly and deep enough? Is the connector damaged? Inspect the VE.Direct port, are there bent pins? If this is the case, use long nose pliers to straighten the pins, while the unit is unpowered.

**VE.Direct TX port issues** Check the "TX port function" setting in VictronConnect. Does the set function match the application it is being used in. To test if the TX port is operational check its functionality using a [TX digital output cable](#).

**VE.Direct RX Port issues** Check the "RX port function" setting in VictronConnect. Does the set function match the application it is being used in. To test if the RX port is operational check its functionality using a [VE.Direct non-inverting remote on/off cable](#).

Note, unlike most other Victron products it is not possible to connect the Multi RS Solar to a GX device (i.e. Cerbo GX) using the VE.Direct interface. You must use the VE.Can interface to connect to a GX device.

### 6.7.4. VE.Smart communication issues

The Multi RS Solar does NOT support VE.Smart networking.

## 6.8. Settings or firmware issues

### 6.8.1. Incorrect settings

Incorrect settings can cause strange solar charger behaviour. Check if all settings are correct.

If in doubt, it could be an option to reset all settings to default using the VictronConnect app and then make all required settings. Consider saving the existing settings before performing a reset.

In most cases the default setting can be used with only minor changes.

If help is required with making settings, please refer to the manual or contact your Victron supplier or distributor.



### 6.8.2. Firmware issues

To rule out a firmware bug, update the firmware.

NOTE: It might be useful to write down the firmware number before and after the update. This can be useful information should you need to request [support](#).

On first connection, the controller might have updated the firmware. If the controller did not automatically ask for a firmware update, check if the controller is running the most up to date firmware and perform a manual update:

- Connect to the controller.

- Click on the settings symbol .
- Click the option symbol .
- Go to product info.
- Check if you are running the latest firmware and look for the text: "This is the latest version".
- If the controller does not have the most up to date firmware, perform a firmware update by pressing the update button.

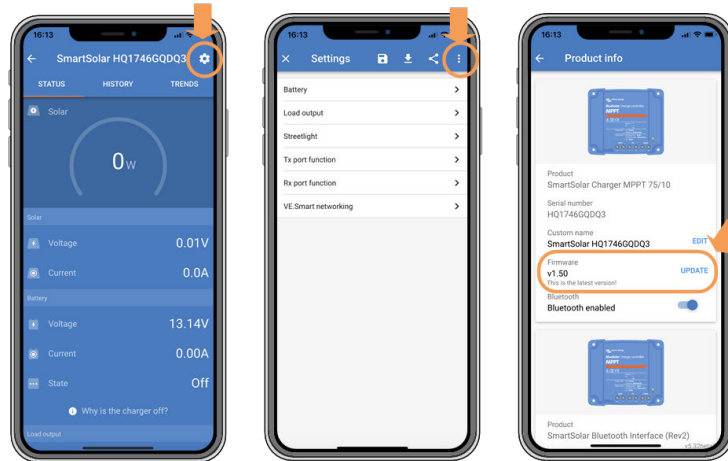

Status screen - Settings screen - Product info screen

### 6.8.3. Interrupted firmware update

This is recoverable and is nothing to worry about. Just try to update the firmware again.

## 6.9. Operation issues

This chapter describes all remaining troubleshooting suggestions that were not covered in previous chapters.

### 6.9.1. Unable to operate as a power supply

We do not recommend to use the solar charger as a power supply, that is without batteries connected.

Operation as a power supply will not damage the solar charger, but it is not guaranteed that the solar charger is able to run all types of loads. Some type of loads might run, others might not. Especially at low load power, the solar charger is too slow to keep the voltage constant. As such, we do not provide support in these kind of situations.

### 6.9.2. Relay issues

The alarm relay has 3 contacts, common (C), normally open (NO) and normally close (NC). It is programmed with the VictronConnect app.

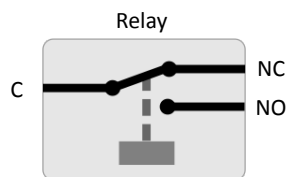

Relay configuration

Use VictronConnect to check the relay functionality setting. When checking the relay check if the relay contacts are opened and closed when the relay is energized and also when the relay is not energized.

The relay gets damaged if a circuit with a current larger than 8A is connected to the relay contacts. This is not covered by warranty.

## 6.10. Errors, and error codes

There are several ways errors are displayed:

- Via VictronConnect, status and history screen
- Via a display
- Via a GX device
- Via VRM (GX device needed)

### 6.10.1. Error codes

In case of an error, an error code will be displayed via VictronConnect, a display, a GX device or on VRM. Each number corresponds with a specific error.

For a full list of error codes and their meaning see the appendix: [Charger error code overview \[45\] \[45\]](#)

#### VictronConnect error reporting

VictronConnect will indicate active errors while VictronConnect is actively connected to the solar charger. The error will show up in a pop-up window in the status screen together with the error number, name and a short error description.

VictronConnect also displays historical errors. To see these errors, navigate to the “History” tab and look at the bottom of each day column. If there is an error, an orange dot will indicate an error.



Active Error and Historical error

#### Errors via a display

The display keeps track of the last 4 errors. The errors are indicated by a number.

#### Monitoring via a GX device and VRM

If the solar charger is connected to a [GX device](#), all its data can be accessed via the GX device. The GX device will also notify in case of solar charger alarms or faults.

For more information see the GX device manual.

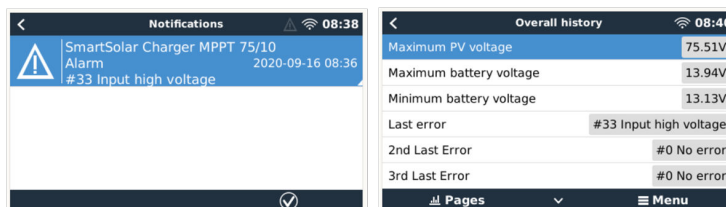

GX device showing alarm notification and historic errors.

If the GX device is connected to [Victron Remote Monitoring \(VRM\) portal](#), the solar charger can be monitored remotely via the internet.

All solar charger data, alarms and errors can be accessed via the VRM portal and solar charger settings can be remotely changed via the VRM portal with the VictronConnect app.

Alarm logs for Margreet test bench CCGX 2				
Device	Triggered by	Description	Started at	Cleared after
Solar Charger [256]	Automatic monitoring	Error code: #33 - Input voltage too high	2020-09-16 08:36:18	6s

*Solar charger alarm logging via VRM***Monitoring via VRM**

If a [GX device](#) is connected to the controller and the GX device is connected to Victron Remote Monitoring (VRM), errors will be sent to the VRM site as well as displayed on the GX device. This way active and past errors can be accessed remotely. Alarm logs are available from the “alarm logs” section on VRM. For more information see the [VRM manual](#).

Alarm logs for Margreet test bench CCGX 2				
Device	Triggered by	Description	Started at	Cleared after
Solar Charger [256]	Automatic monitoring	Error code: #33 - Input voltage too high	2020-09-16 08:36:18	6s

*VRM Alarm logs***6.11. Warranty**

This product has a 5-year limited warranty. This limited warranty covers defects in materials and workmanship in this product and lasts for five years from the date of original purchase of this product. To claim warranty the customer must return the product together with the receipt of purchase to the point of purchase. This limited warranty does not cover damage, deterioration or malfunction resulting from alteration, modification, improper or unreasonable use or misuse, neglect, exposure to excess moisture, fire, improper packing, lightning, power surges, or other acts of nature. This limited warranty does not cover damage, deterioration or malfunction resulting from repairs attempted by anyone unauthorized by Victron Energy to make such repairs. Non-compliance with the instructions in this manual will render the warranty void. Victron Energy is not liable for any consequential damages arising from the use of this product. The maximum liability of Victron Energy under this limited warranty shall not exceed the actual purchase price of the product.



## 7. Technical Specifications

Multi RS Solar 48/6000/100-450/80 1 tracker - PMR482602000	
<b>INVERTER</b>	
DC Input voltage range	38 – 62V
Output	Output voltage: 230 VAC $\pm$ 2% Frequency: 50 Hz $\pm$ 0,1% (1)
Continuous output power at 25°C	Increases linearly from 4800W at 46 VDC to 5300W at 52 VDC
Continuous output power at 40°C	4500W
Continuous output power at 65°C	3000W
Peak power	9kW for 3 seconds
Short-circuit output current	50 A
Max. AC output overcurrent protection	30 A
Maximum efficiency	96.5% at 1 kW load 94% at 5 kW load
Zero load power	20W
Low battery shutdown	37.2 V (adjustable)
Low battery restart	43.6 V (adjustable)
<b>SOLAR</b>	
Maximum DC voltage	450 V
Start-up voltage	120 V
MPPT voltage range (2)	80 – 450 V
Maximum operational PV input current	18 A
Max. PV short circuit current reverse polarity protection (3)	20 A
Maximum DC charging power	4000 W
Max. PV short circuit current (Isc PV)	30 A
Earth leakage trip level	30 mA
Isolation fail level (detection before start-up)	100 k $\Omega$
<b>CHARGER</b>	
Programmable charger voltage range (2)	Minimum: 36 V Maximum 60 V (8)
Charge voltage 'absorption'	default: 57.6 V (adjustable)
Charge voltage 'float'	default: 55.2 V (adjustable)
Maximum charge current (4)	100 A
Battery temperature sensor	Included
Battery voltage sense	Yes
<b>GENERAL</b>	
Parallel and 3-phase operation	No
Auxiliary output	No
Programmable relay (5)	Yes

Multi RS Solar 48/6000/100-450/80 1 tracker - PMR482602000	
Protection (6)	a - g
Data Communications	VE.Direct port, VE.Can port & Bluetooth (7)
Bluetooth frequency	2402 - 2480 Mhz
Bluetooth power	4dBm
General purpose analog/digital in port	Yes, 2x
Remote on-off	Yes
Operating temperature range	-40 to +65°C (fan assisted cooling)
Humidity (non-condensing)	max 95%
<b>ENCLOSURE</b>	
Material & Color	steel, blue RAL 5012
Protection category	IP21
Battery-connection	M8 bolts
PV Connection	2 positive & 2 negative MC4
230 V AC-connection	Screw terminals 13 mm <sup>2</sup> (6 AWG)
Weight	11 kg
Dimensions (hwxwd)	425 x 440 x 125 mm
<b>STANDARDS</b>	
Safety	EN-IEC 60335-1, EN-IEC 60335-2-29, EN-IEC 62109-1, EN-IEC 62109-2
Emission, Immunity	EN 55014-1, EN 55014-2 EN-IEC 61000-3-2, EN-IEC 61000-3-3 IEC 61000-6-1, IEC 61000-6-2, IEC 61000-6-3
<p>1) Can be adjusted to 60 Hz</p> <p>2) MPPT operating range is also constrained by battery voltage - PV VOC should not exceed 8x battery float voltage. For example, a 52,8V float voltage results in a maximum PV VOC of 422,4V. See product manual for further information.</p> <p>3) A higher short circuit current may damage the controller if PV array is connected in reverse polarity.</p> <p>4) The maximum charge current from the built in MPPT is 80A, to reach the 100A maximum charge current of the unit requires additional AC PV connected.</p> <p>5) Programmable relay which can be set for general alarm, DC under voltage or genset start/stop function, including minimum closed time and relay-off delay. DC rating: 4A up to 35VDC and 1A up to 70VDC</p> <p>6) Protection key:</p> <ul style="list-style-type: none"> <li>a) output short circuit</li> <li>b) overload</li> <li>c) battery voltage too high</li> <li>d) battery voltage too low</li> <li>e) temperature too high</li> <li>f) 230 VAC on inverter output</li> <li>g) Solar earth leakage</li> </ul> <p>7) The Multi RS Solar is not currently compatible with VE.Smart Networks. Connection to a GX device (i.e. Cerbo GX) must be made via the VE.Can interface. The VE.Direct interface is for connection to the GlobalLink 520.</p> <p>8) The Charger set-point (load and absorption) can be set to max 60 V. The output voltage at the charger terminals can be higher, due to temperature compensation as well as compensation for voltage drop over the battery cables. The maximum output current is reduced on a linear basis from full current at 60V to 5A at 62V. The equalization voltage can be set to max 62V, the equalization current percentage can be set to max 6%.</p>	

## 8. Appendix

### 8.1. Appendix A : Connection Overview

Figure 2. Multi RS Solar Front

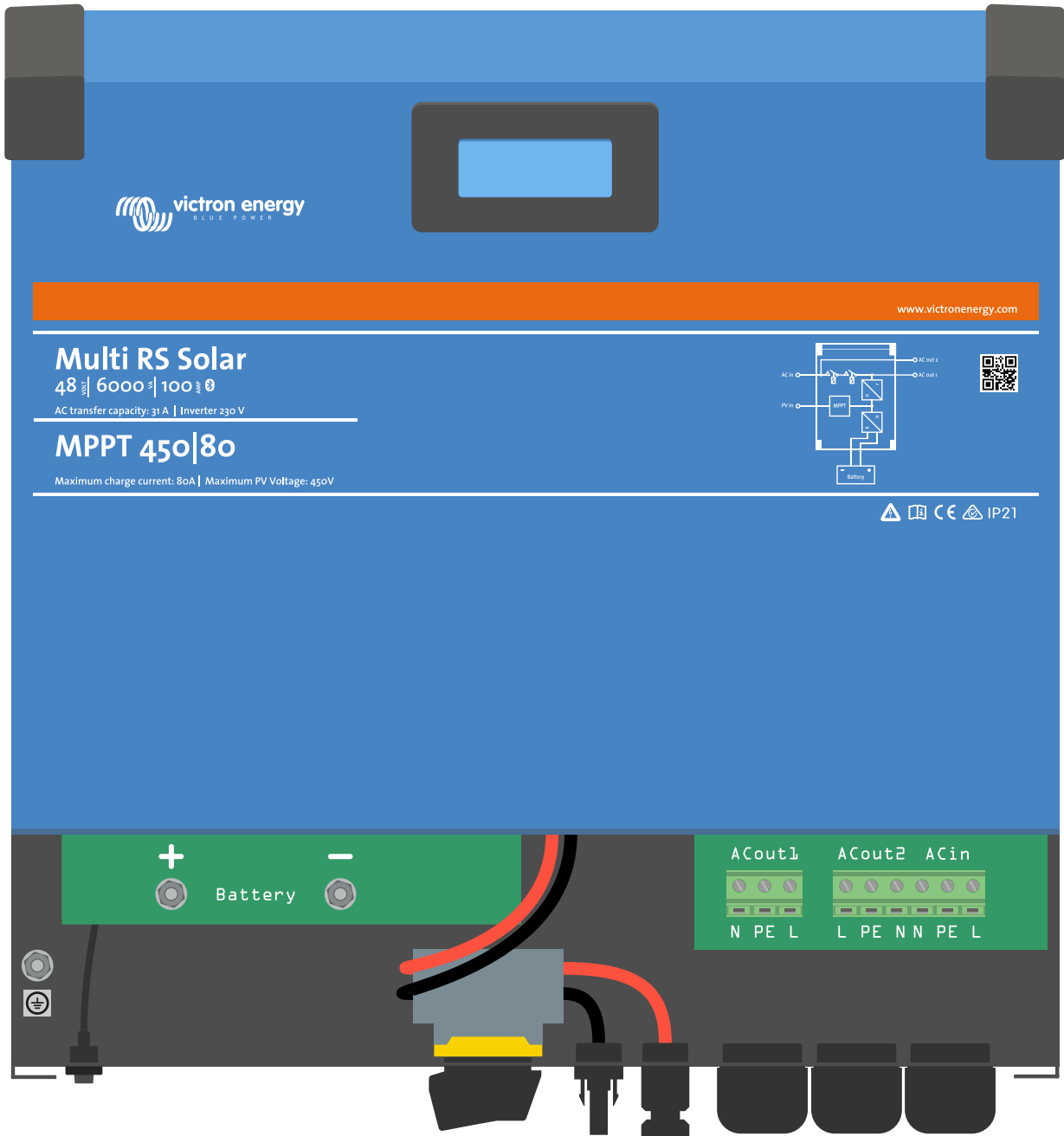

Figure 3. Multi RS Solar Bottom

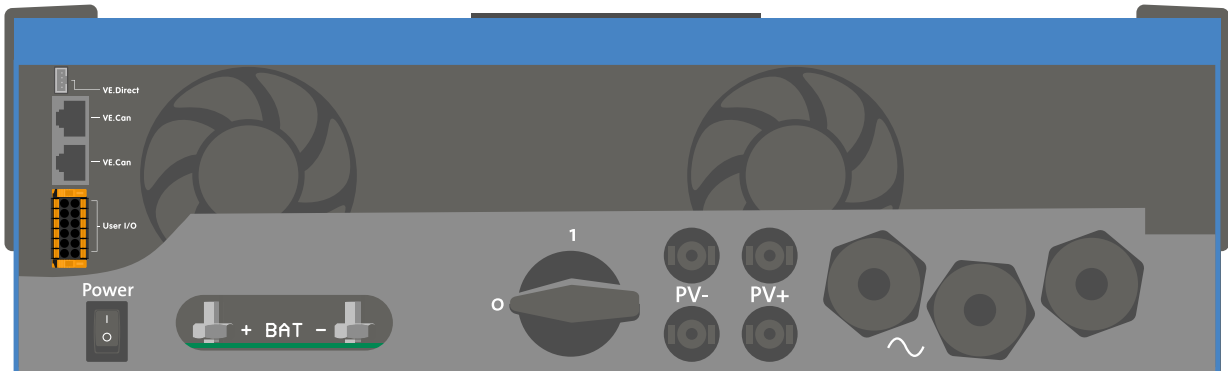
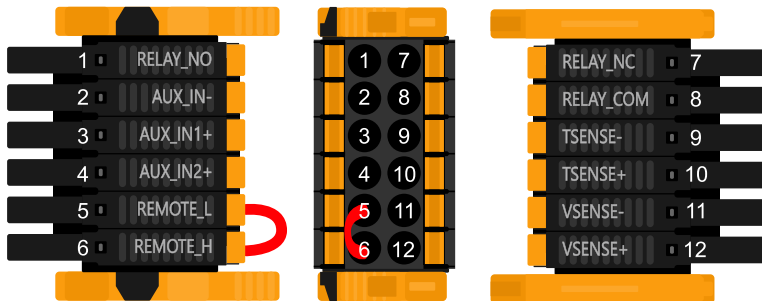

Figure 4. User I/O



User I/O Connector is located on bottom left side of connection area, diagram shows 3 perspectives. Left Side - Top - Right Side

Table 4. User I/O Functions - See Installation Section for more details.

Number	Connection	Description
1	Relay_NO	Programmable relay Normally Open connection
2	AUX_IN -	Common negative for programmable auxiliary inputs
3	AUX_IN1+	Programmable auxiliary input 1 positive connection
4	AUX_IN2+	Programmable auxiliary input 2 positive connection
5	REMOTE_L	Remote on/off connector Low
6	REMOTE_H	Remote on/off connector High
7	RELAY_NC	Programmable relay Normally Closed connection
8	RELAY_COM	Programmable relay common negative
9	TSENSE -	Temperature Sensor negative
10	TSENSE +	Temperature Sensor positive
11	VSENSE -	Voltage Sensor negative
12	VSENSE +	Voltage Sensor positive

## 8.2. Appendix B : Block Diagram

Figure 5. Multi RS Solar

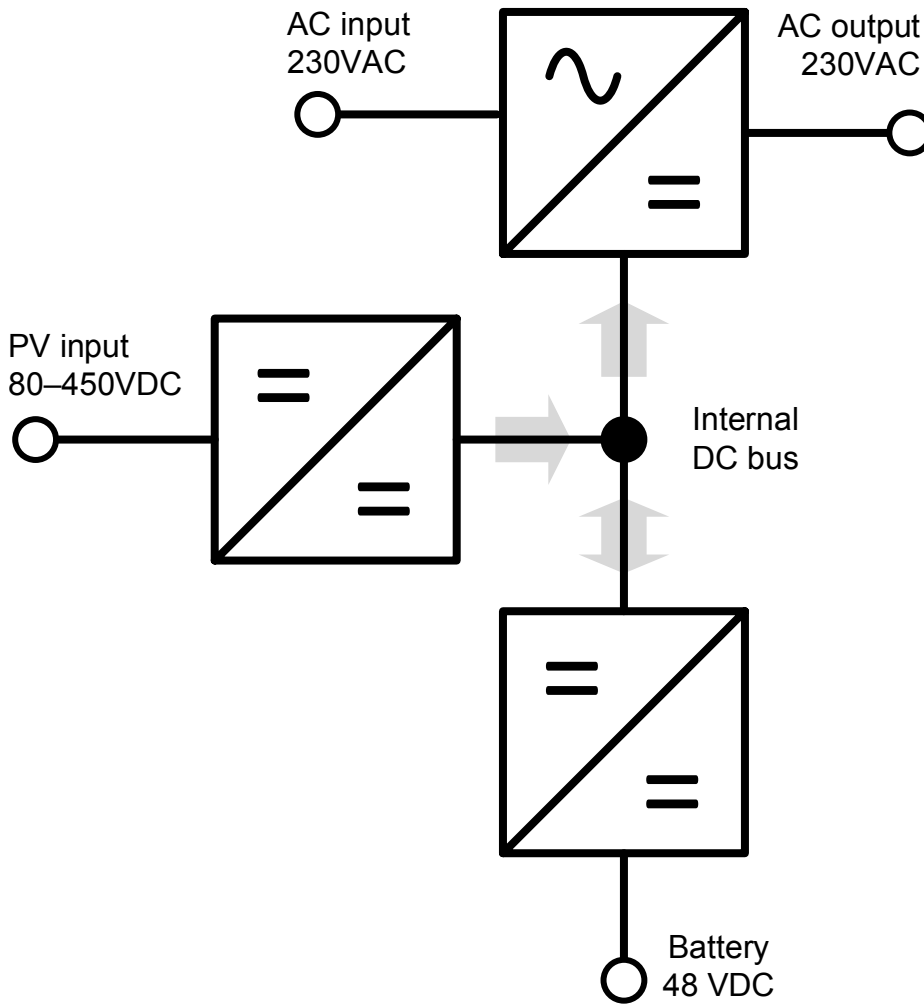

### 8.3. Appendix C : Example Wiring Diagram

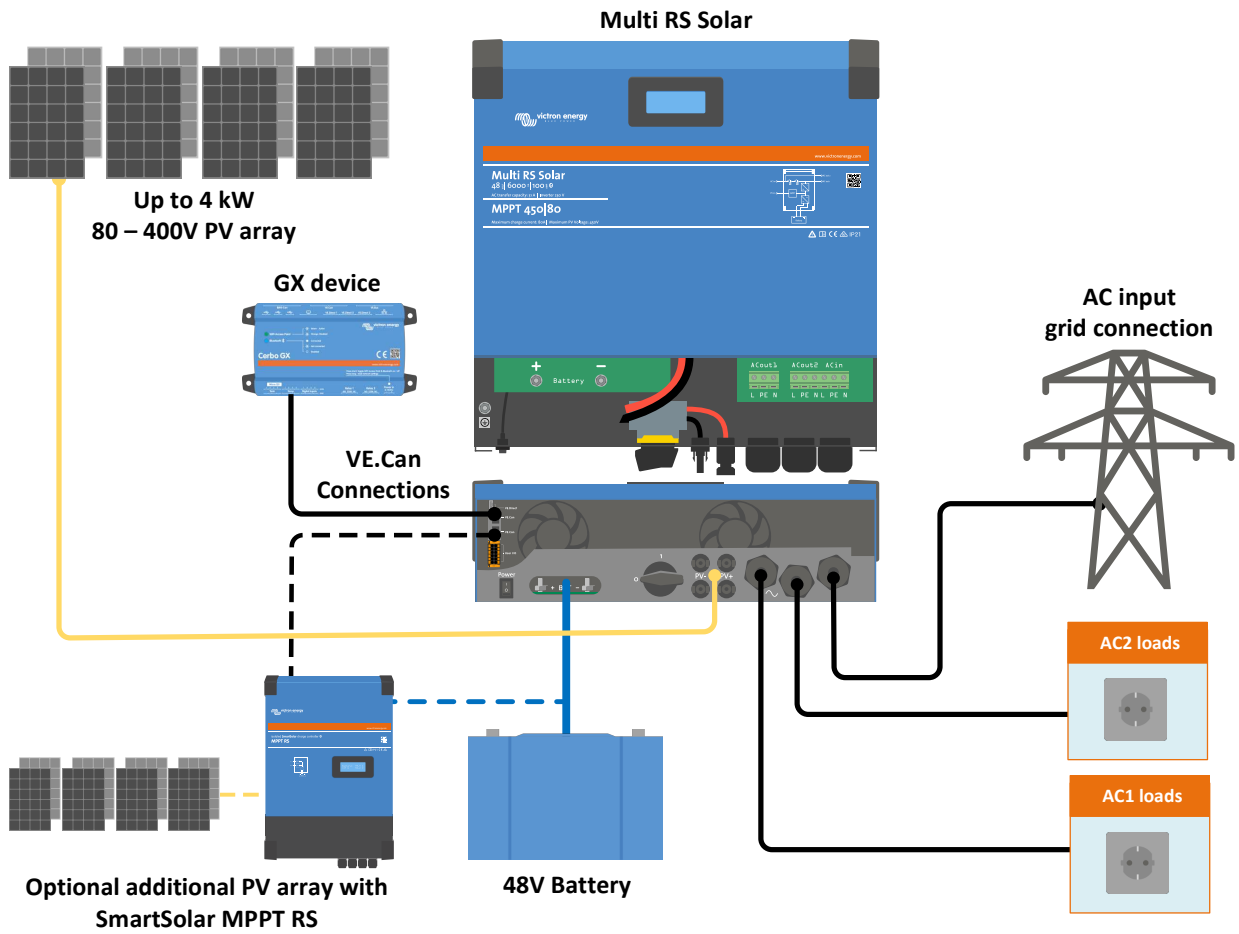
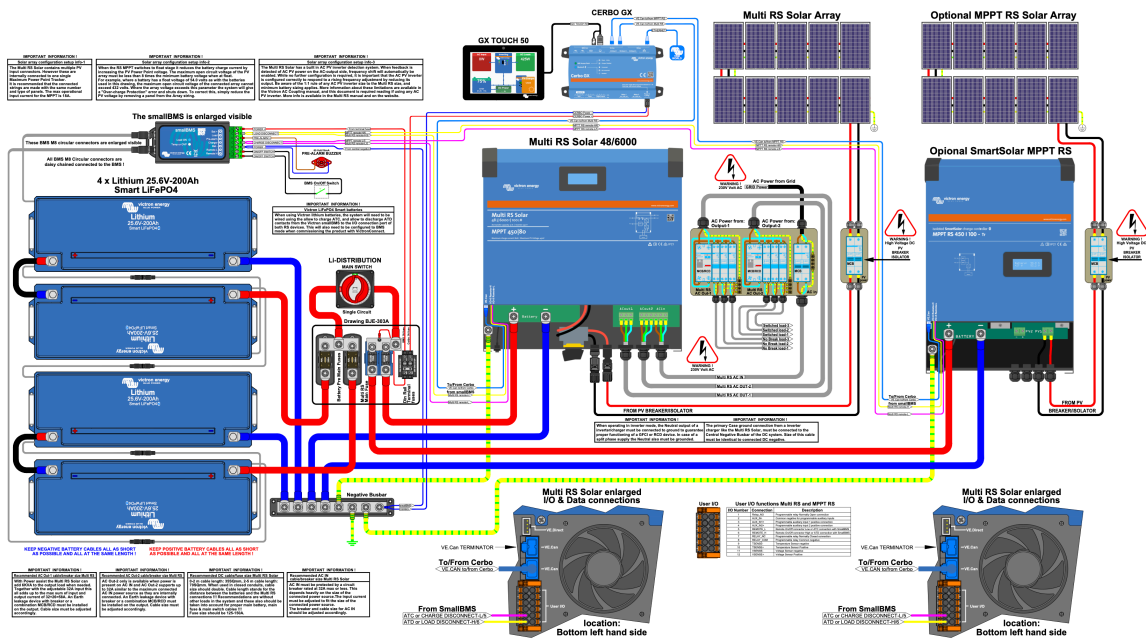

Figure 6. Multi RS Solar full wiring diagram



See here for highest resolution and most up-to-date schematics - <https://www.victronenergy.com/inverters-chargers/multi-rs-solar#system-schematic>

### 8.4. Appendix D : Dimensions

Figure 7. Multi RS Solar

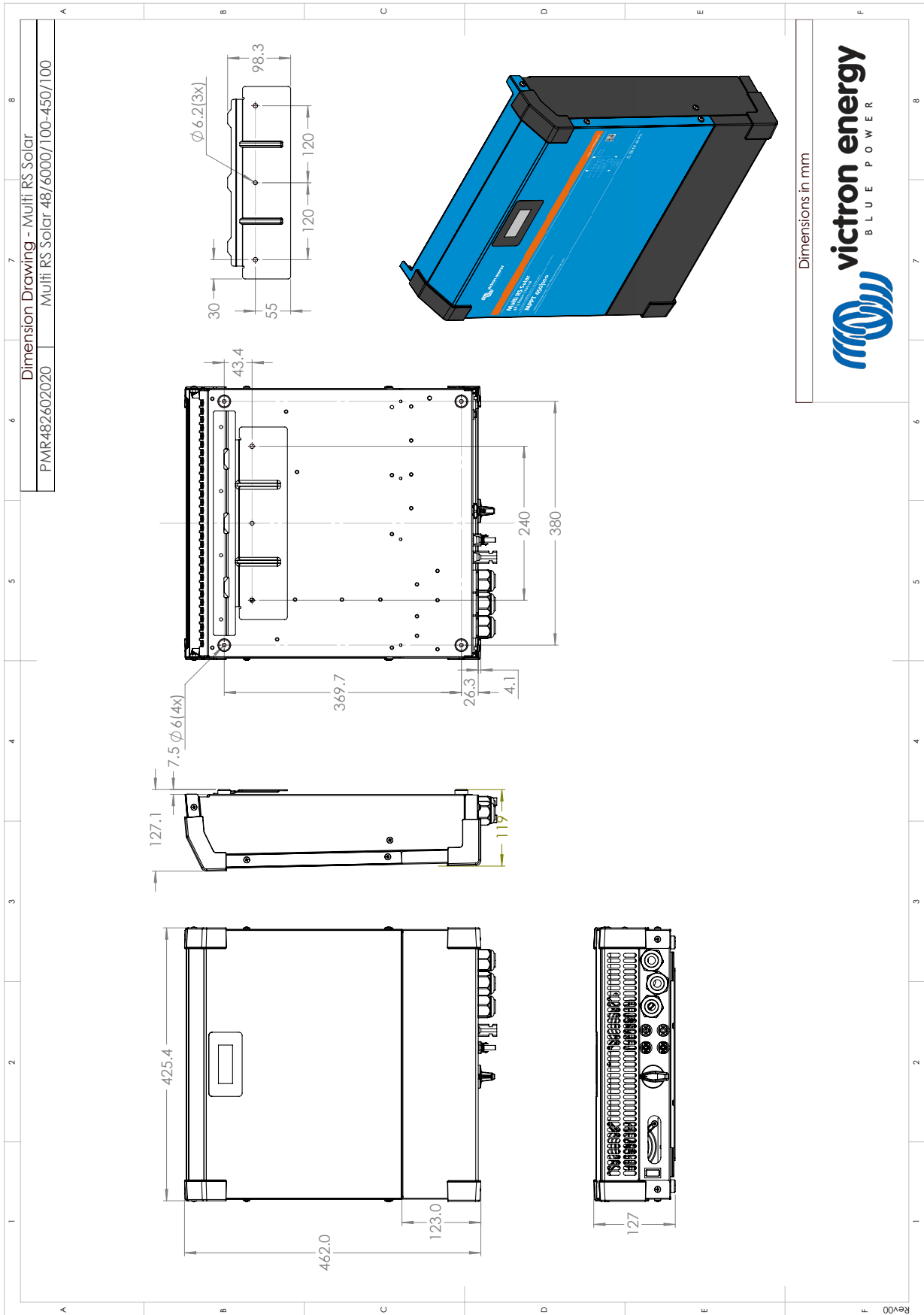



## 8.5. Error Codes

### 8.5.1. Error 2 - Battery voltage too high

This error will auto-reset after the battery voltage has dropped. This error can be due to other charging equipment connected to the battery or a fault in the charge controller.

### 8.5.2. Error 3, Err 4 - Remote temperature sensor failure

Check if the T-sense connector is properly connected to a remote temperature sensor. Most likely cause: the remote T-sense connector is connected to the BAT+ or BAT- terminal. This error will auto-reset after proper connection.

### 8.5.3. Error 5 - Remote temperature sensor failure (connection lost)

Check if the T-sense connector is properly connected to a remote temperature sensor. This error will not auto-reset.

### 8.5.4. Error 6, Error 7 - Remote battery voltage sense failure

Check if the V-sense connector is properly connected to the battery terminals. Most likely cause: the remote V-sense connector is connected in reverse polarity to the BAT+ or BAT- terminals.

### 8.5.5. Error 8 - Remote battery voltage sense failure (connection lost)

Check if the V-sense connector is properly connected to the battery terminals.

### 8.5.6. Error 11 - Battery high ripple voltage

High DC ripple is usually caused by loose DC cable connections and/or too thin DC wiring. After the inverter has switched off due to high DC ripple voltage, it waits 30 seconds and then restarts.

After three restarts followed by a shutdown due to high DC ripple within 30 seconds of restarting, the inverter will shutdown and stops retrying. To restart the inverter, switch it Off and then On.

Continuous high DC ripple reduces the inverter life expectancy

### 8.5.7. Error 14 - Battery low temperature

The charger is stopped to avoid charging LiFePO4 batteries at low temperature as this damages the cells.

### 8.5.8. Error 20 - Maximum Bulk-time exceeded

#### Solar Chargers

The maximum bulk time protection is a feature that was in the chargers when they were just released (2015 or earlier) and later the feature was removed.

If you do see this error, then update to the latest firmware.

If you then still have the error, perform a reset to factory defaults of the configuration, and reconfigure the solar charger.

#### AC Chargers

This protection is default enabled on the Skylla-i and the Skylla IP44.

This error is generated when the battery-absorption-voltage is not reached after 10 hours of charging.

The feature of this safety protection is to detect a shorted cell; and stop charging.

### 8.5.9. Error 22, 23 - Internal temperature sensor failure

The internal temperature measurements are out of range. Disconnect all wires, and then reconnect all wires, to restart the unit. This error will not auto-reset. If the error remains, please contact your dealer, there might be a hardware defect.

### 8.5.10. Error 26 - Terminal overheated

Power terminals overheated, check wiring, including the wiring type and type of strands, and/or fasten bolts if possible.

This error will auto-reset.

### 8.5.11. Error 27 - Charger short circuit

This error will auto-reset. If the error does not auto-reset disconnect the charge controller from all power-sources, wait 3 minutes, and power up again. If the error persists the charge controller is probably faulty.

### 8.5.12. Error 28 - Power stage issue

This error will not auto-reset.

Disconnect all wires, and then reconnect all wires. If the error persists the charge controller is probably faulty.

Note that this error was introduced in v1.36. So when doing an update, it might look like the firmware update caused this issue; but it doesn't. The Solar charger was then already not performing 100% before the update; updating to v1.36 or later merely made the issue more visible. The unit needs to be replaced.

### 8.5.13. Error 29 - Over-Charge protection

This error will auto-reset. This protection looks at the actual battery voltage and compares this to the settings. In case your actual voltage is above what is expected it shuts down to isolate the battery from the rest of the unit. Firstly check battery settings (absorption/float voltages) to see if something is wrong here. Another possible cause is an over-sized PV array configuration, if there are too many panels in series the battery voltage cannot be reduced any further. Consider modifying PV panel wiring to reduce the PV voltage.

### 8.5.14. Error 43 - Inverter shutdown (Ground Fault)

The voltage difference between Neutral and Ground is too high.

Inverter or Multi (not connected to the grid):

- The internal ground relay is activated but the voltage over the relay is too high. The relay might be damaged.

Multi (connected to the grid):

- The ground wire in the installation is not present or not connected properly.
- Line and Neutral are swapped in the installation.

This error will not auto-reset. Check the installation and restart the unit using the power-switch.

### 8.5.15. Error 50, Error 52 - Inverter overload, Inverter peak current

Some loads like motors or pumps draw large inrush currents in a start-up situation. In such circumstances, it is possible that the start-up current exceeds the over current trip level of the inverter. In this case the output voltage will quickly decrease to limit the output current of the inverter. If the over current trip level is continuously exceeded, the inverter will shut down: wait 30 seconds and then restart.

The Inverter can supply more power than the nominal power level for a short time. If the time is exceeded the inverter stops.

After three restarts followed by another overload within 30 seconds of restarting, the inverter will shutdown and remain off. To restart the inverter, switch it Off, then On.

If the error persists reduce the load on the AC out terminal by switching off or disconnecting appliances.

### 8.5.16. Error 51 - Inverter temperature too high

A high ambient temperature or enduring high load may result in shut down to over temperature. Reduce load and/or move inverter to better ventilated area and check for obstructions near the fan outlets.

The inverter will restart after 30 seconds. The inverter will not stay off after multiple retries.

### 8.5.17. Error 53, Error 54 - Inverter output voltage

If the battery voltage is getting low and a large load is applied to the AC output the inverter is unable to maintain the proper output voltage. Re-charge the battery or reduce the AC loads to continue operation.

### 8.5.18. Error 55, Error 56, Error 58 - Inverter self test failed

The inverter performs diagnostic tests before it activates its output. In the case that one of these tests fails an error message is displayed and the inverter does not turn on.

First try to restart the inverter, by switching it Off, and then On. If error persists the inverter is probably faulty.

### 8.5.19. Error 57 - Inverter ac voltage on output

There is already AC voltage on the AC out terminal before switching on the inverter. Check that the AC out is not connected to a mains outlet or to another inverter.

This error will not auto-reset. Check the installation and restart the unit using the power-switch.

### 8.5.20. Notification 65 - Communication warning

Communication with one of the paralleled controllers was lost. To clear the warning, switch the controller off and back on

### 8.5.21. Notification 66 - Incompatible device

The controller is being paralleled to another controller that has different settings and/or a different charge algorithm.

Make sure all settings are the same and update firmware on all chargers to the latest version

### 8.5.22. Error 67 - BMS Connection lost

The charger is configured to be controlled by a BMS, but it does not receive any control messages from a BMS. The charger stopped charging, as a safety precaution.

This Error only shows when there is solar power available and thus the Solarcharger is ready to initiate charging. It does not show at night. And in case there is a permanent problem, the error will raise in the morning and clear at night, and so forth.

Check the connection between the charger and the BMS.

How to reconfigure the charger to standalone mode

Our Chargers and Solarchargers automatically configure themselves to be BMS-controlled when they are connected to one; either direct or via a GX Device. And that setting is semi-permanent: power cycling the charger will not reset it.

Here is what needs to be done to make the charger operate in stand-alone mode again, ie. not controlled by a BMS:

- VE.Can solar chargers, go into the setup menu, and change setting 'BMS' from 'Y' to 'N' (setup item 31).
- VE.Direct solar chargers, reset the charger to factory defaults with VictronConnect, and then reconfigure it.

### 8.5.23. Error 68 - Network misconfigured

Applies to SmartSolar/BlueSolar MPPTs VE.Can (FW version v1.04 or higher) and SmartSolar VE.Direct MPPTs (FW version v1.47).

To clear the error on the SmartSolar VE.Direct MPPTs update the FW version to v1.48 or higher.

To clear the error on the SmartSolar/BlueSolar MPPTs VE.Can, update the software. If the error persists, it will be because the charger is connected with both a VE.Direct cable and on VE.Can. That is not supported. Remove one of the two cables. The error will disappear and the charger will resume normal operation, within a minute.

### 8.5.24. Error 114 - CPU temperature too high

This error will reset after the CPU has cooled down. If the error persists, check the ambient temperature and check for obstructions near the air inlet and outlet holes of the charger cabinet. Check manual for mounting instructions with regard to cooling. If error persists the controller is probably faulty.

### 8.5.25. Error 116 - Calibration data lost

If the unit does not work and error 116 pops up as the active error the unit is faulty, contact your dealer for a replacement.

If the error is only present in the history data and the unit operates normally this error can be ignored safely. Explanation: when the units power up for the very first time in the factory, it does not have calibration data and an error 116 is logged. Obviously this should have been cleared, but in the beginning units left the factory with this message still in the history data.

SmartSolar models (not the BlueSolar models): upgrading to v1.4x firmware is a one-way trip, you cannot go back to an older firmware version once you upgrade to v1.4x. Reverting to older firmware gives error 116 (calibration data lost), this can be fixed by re-installing the v1.4x firmware.

### 8.5.26. Error 119 - Settings data lost

The charger cannot read its configuration, and stopped.

This error will not auto-reset. To get it working again:

1. First, restore it to factory defaults. (top right in Victron Connect, click on the three dots)

2. Disconnect the charge controller from all power-sources
3. wait 3 minutes, and power up again.
4. Reconfigure the charger.

Please report this to your Victron dealer and ask them to escalate the matter to Victron; as this error should never happen. Preferably include firmware version and any other specifics (VRM URL, VictronConnect screenshots or similar).

#### **8.5.27. Error 121 - Tester fail**

If the unit does not work and error 121 pops up as the active error the unit is faulty, contact your dealer for a replacement. If the error is only present in the history data and the unit operates normally this error can be ignored safely. Explanation: when the unit powers up for the very first time in the factory, it does not have calibration data and an error 121 is logged. Obviously this should have been cleared, but in the beginning units left the factory with this message still in the history data.

#### **8.5.28. Err 200, X95 - Internal DC voltage error**

The unit performs internal diagnostics when activating its internal DC-DC converter. This error indicates that something is wrong with the DC-DC converter.

This error will not auto-reset. Check the installation and restart the unit using the power-switch. If the error persists the unit is probably faulty.

#### **8.5.29. Err 201 - Internal DC voltage error**

Internal DC voltage measurement error, is raised in case an internal (high-) voltage measurement does not match certain criteria. And it means that a measurement circuit inside the unit is broken.

Make sure to update the firmware to at least v1.08, in previous firmwares the limits were too strict. And it could trigger falsely during MPPT start-up in the morning and MPPT shutdown in the evening.

The unit might have seemingly worked fine before the firmware update; but it is really broken, not safe for use, and if it hadn't stopped working already then it would have stopped working soon. Which is why we added this internal check.

This error will not auto-reset. Check the installation and restart the unit using the power-switch. If the error persists the unit is probably faulty and must be sent in for repair/replacement.

#### **8.5.30. Err 203, Err 205, Err 212, Err 215 - Internal supply voltage error**

The unit performs internal diagnostics when activating its internal voltage supplies. This error indicates that something is wrong with an internal supply voltage.

This error will not auto-reset. Check the installation and restart the unit using the power-switch. If the error persists the unit is probably faulty.