



# Cerbo GX Manual

# Table of Contents

<b>1. Introduction</b>	<b>1</b>
1.1. What is the Cerbo GX?	1
1.2. What's in the box?	1
<b>2. Installation</b>	<b>2</b>
2.1. Overview of connections	2
2.2. Power	2
2.3. Mounting options and accessories	3
2.4. Connecting Victron products	3
2.4.1. Multis/Quattros/Inverters (VE.Bus products)	3
2.4.2. Battery Monitor SmartShunt, BMV-700 series; and MPPTs with a VE.Direct port	4
2.4.3. VE.Can Devices	5
2.4.4. VE.Can and BMS-Can Interfaces	5
2.4.5. Inverter RS, Multi RS and MPPT RS	6
2.4.6. BMV-600 series	6
2.4.7. DC Link box	6
2.4.8. VE.Can Resistive Tank Sender Adapter	6
2.5. Connecting a PV Inverter	6
2.6. Connecting a USB GPS	7
2.7. Connecting a NMEA 2000 GPS	7
2.8. Connecting a Fischer Panda Generator	8
2.9. Connecting a GX Tank 140	8
2.10. Connecting Tank Level Sensors	8
2.11. Connecting third-party NMEA 2000 tank senders	9
2.12. Connecting Temperature Sensors	9
2.12.1. Hardwired sensors	9
2.12.2. Wireless bluetooth Ruuvi sensors	11
2.13. Connecting IMT Solar Irradiance, Temperature and Wind Speed Sensors	12
2.13.1. Data Visualisation - VRM	15
2.14. Relay connections	16
2.15. AC load monitoring	17
<b>3. Internet connectivity</b>	<b>18</b>
3.1. Ethernet LAN port	18
3.2. Wi-Fi	18
3.3. GX GSM	19
3.4. Mobile (cellular) network using a 3G or 4G router	19
3.5. USB tethering using a mobile phone	19
3.6. IP Configuration	19
3.7. Connecting both Ethernet and Wi-Fi (failover)	20
3.8. Minimize internet traffic	20
3.9. More information about setting up an internet connection and VRM	20
<b>4. Accessing the GX device</b>	<b>21</b>
4.1. Using VictronConnect via Bluetooth	21
4.2. Accessing via the built-in WiFi Access Point	24
4.3. Accessing Remote Console via the local LAN/WiFi Network	24
4.3.1. Alternative methods to find the IP Address for Remote Console	25
4.4. Accessing via VRM	27
<b>5. Configuration</b>	<b>29</b>
5.1. Menu structure and configurable parameters	29
5.2. Battery state of charge (SoC)	36
5.2.1. Which device should I use for SoC calculation?	36
5.2.2. The different solutions explained in detail	36
5.2.3. Notes on SoC	37
5.2.4. Selecting SoC source	38
5.2.5. Details on VE.Bus SOC	38
5.2.6. The System Status menu	38
5.3. Customize the logo on the Boat & Motorhome page	39
5.4. Temperature relay	40

<b>6. Firmware updates</b> .....	<b>42</b>
6.1. Changelog .....	42
6.2. Via internet or with microSD-card/USB-stick .....	42
6.2.1. Direct download from the internet .....	42
6.2.2. microSD-card or USB-stick .....	42
6.3. Revert to a previous firmware version .....	43
6.3.1. Stored firmware backup feature .....	43
6.3.2. Install a specific firmware version from SD/USB .....	43
6.4. Venus OS Large image .....	44
<b>7. VE.Bus Inverter/charger monitoring</b> .....	<b>45</b>
7.1. Input current-limiter setting .....	45
7.2. Phase rotation warning .....	46
7.3. Grid failure monitoring .....	47
7.4. Advanced menu .....	47
<b>8. DVCC - Distributed Voltage and Current Control</b> .....	<b>48</b>
8.1. Introduction and features .....	48
8.2. DVCC Requirements .....	49
8.3. DVCC effects on the charge algorithm .....	50
8.4. DVCC features for all systems .....	50
8.4.1. Limit charge current .....	50
8.4.2. Limit managed battery charge voltage .....	51
8.4.3. Shared Voltage Sense (SVS) .....	51
8.4.4. Shared Temperature Sense (STS) .....	52
8.4.5. Shared Current Sense (SCS) .....	52
8.5. DVCC features when using CAN-bus BMS battery .....	53
8.6. DVCC for systems with the ESS Assistant .....	54
<b>9. VRM Portal</b> .....	<b>55</b>
9.1. VRM Portal Introduction .....	55
9.2. Registering on VRM .....	55
9.3. Datalogging to VRM .....	55
9.4. Troubleshooting data logging .....	56
9.5. Analysing data offline, without VRM .....	59
9.6. Remote Console on VRM - Troubleshooting .....	59
<b>10. Marine MFD integration by App</b> .....	<b>61</b>
10.1. Introduction & requirements .....	61
10.2. Compatible MFDs and instructions .....	62
<b>11. Marine MFD integration by NMEA2000</b> .....	<b>63</b>
11.1. NMEA2000 Introduction .....	63
11.2. Supported Devices / PGNs .....	63
11.3. NMEA2000 Configuration .....	64
11.4. NMEA2000 Configuring device instances .....	65
11.5. NMEA2000-out technical details .....	66
11.5.1. NMEA2000 Glossary .....	66
11.5.2. NMEA2000 Virtual-devices .....	66
11.5.3. NMEA2000 Classes and functions .....	66
11.5.4. NMEA2000 Instances .....	66
11.5.5. NMEA2000 Changing Instances .....	67
11.5.6. PGN 60928 NAME Unique Identity Numbers .....	68
<b>12. RV-C Support</b> .....	<b>69</b>
12.1. RV-C Introduction .....	69
12.2. Limitations .....	69
12.3. Supported Devices .....	70
12.4. RV-C Configuration .....	70
12.5. Garnet SeeLevel II 709-RVC & Victron GX device support .....	70
12.5.1. Wiring the Garnet SeeLevel II 709-RVC tank level sensor to a GX device .....	71
12.5.2. Installation and configuration .....	71

<b>13. Wakespeed WS500 support</b> .....	<b>72</b>
13.1. Introduction .....	72
13.2. Requirements .....	72
13.3. Wiring the WS500 to VE.Can .....	72
13.4. Wiring Example .....	72
13.5. GX device user interface for WS500 .....	73
13.6. VRM Portal .....	74
13.7. Troubleshooting .....	74
13.7.1. Error code #91 and #92 .....	74
13.7.2. Current field contains two dashes .....	74
<b>14. Mopeka Pro sensor support</b> .....	<b>76</b>
14.1. Introduction .....	76
14.2. Installation .....	76
14.3. Configuration .....	77
14.4. Tank level monitoring .....	78
<b>15. Digital Inputs</b> .....	<b>79</b>
15.1. Configuration .....	79
15.2. Read-out of digital inputs via Modbus-TCP .....	80
<b>16. GX - Generator auto start/stop</b> .....	<b>81</b>
16.1. GX - Generator auto start/stop .....	81
16.2. Wiring .....	81
16.3. Enabling the start/stop function .....	81
16.4. General start/stop - Main Page .....	82
16.5. Settings .....	82
16.6. Conditions: User-definable parameters which trigger a generator auto-start. ....	83
16.7. Troubleshooting .....	87
<b>17. Reset to factory defaults procedure</b> .....	<b>88</b>
<b>18. Error Codes</b> .....	<b>89</b>
<b>19. More information</b> .....	<b>90</b>
<b>20. FAQ</b> .....	<b>91</b>
20.1. Q1: I cannot switch my Multi/Quattro system on or off .....	91
20.2. Q2: Do I need a BMV to see proper battery state of charge? .....	91
20.3. Q3: I have no internet, where can I insert a sim-card? .....	91
20.4. Q4: Can I connect both a GX Device and a VGR2/VER to a Multi/Inverter/Quattro? .....	91
20.5. Q5: Can I connect multiple Cerbo GX to a Multi/Inverter/Quattro? .....	91
20.6. Q6: I see incorrect current (amps) or power readings on my Cerbo GX .....	92
20.7. Q7: There is a menu entry named "Multi" instead of the VE.Bus product name .....	92
20.8. Q8: There is a menu entry named "Multi", while there is no Inverter, Multi or Quattro connected .....	92
20.9. Q9: When I type the ip-address of the Cerbo GX into my browser, I see a web page mentioning Hiawatha? .....	93
20.10. Q10: I have multiple Solar chargers MPPT 150/70 running in parallel. From which one will I see the relay status in the Cerbo GX menu? .....	93
20.11. Q11: How long should an automatic update take? .....	93
20.12. Q12: I have a VGR with IO Extender, how can I replace this with a Cerbo GX? .....	93
20.13. Q13: Can I use Remote VEConfigure, as I was doing with the VGR2? .....	93
20.14. Q14: The Blue Power Panel could be powered through the VE.Net network, can I also do that with a Cerbo GX? .....	93
20.15. Q15: What type of networking is used by the Cerbo GX (TCP and UDP ports)? .....	93
20.16. Q16: What is the functionality behind the menu item Remote support (SSH), in the Ethernet menu? .....	94
20.17. Q17: I don't see support for VE.Net products in the list, is that still coming? .....	94
20.18. Q18: What is the data usage of the Cerbo GX? .....	94
20.19. Q19: How many AC Current Sensors can I connect in one VE.Bus system? .....	94
20.20. Q20: Issues with Multi not starting when Cerbo GX is connected / Caution when powering the Cerbo GX from the AC-out terminal of a VE.Bus Inverter, Multi or Quattro .....	94
20.21. Q21: I love Linux, programming, Victron and the Cerbo GX. Can I do more? .....	95
20.22. Q22: How do I change the logo .....	96
20.23. Q23: Multi restarts all the time (after every 10sec) .....	96

20.24. Q24: What is Error #42? .....	96
20.25. Q25: My GX device reboots itself. What is causing this behavior? .....	96
20.26. <b>GPL Note</b> .....	97
<b>21. Appendix</b> .....	<b>98</b>
21.1. RV-C .....	98
21.1.1. Supported DGNs .....	98
21.1.2. RV-C out .....	98
21.1.3. DGN 60928 Unique Identity Numbers .....	101
21.1.4. RV-C in .....	101
21.1.5. Device Classes .....	101
21.1.6. Instance Translation .....	102
21.1.7. RV-C Fault and Error Handling .....	102
21.1.8. RV-C Device Priority .....	102

# 1. Introduction

## 1.1. What is the Cerbo GX?

The Cerbo GX sits at the heart of your energy installation. All the other system-components - such as inverter/chargers, solar chargers, and batteries - are connected to it. The Cerbo GX ensures that they all work in harmony.

There is an optional touch screen accessory for the Cerbo GX called the [GX Touch](#).

Monitoring of the system can be done either with the Cerbo GX in front of you - or from anywhere in the world using an internet connection and the [VRM Portal](#).

The Cerbo GX also provides [Remote firmware updates](#) and allows settings to be changed Remotely.

The Cerbo GX is part of the [GX product family](#). GX products are Victron's state-of-the-art monitoring solution that run our Venus OS operating system.

All the information in this manual refers to the latest software. You can check your device has the latest version in the [Firmware menu](#) when the GX device is connected to the internet. For installations without internet, you can find the latest version in [Victron Professional](#).

## 1.2. What's in the box?

- Cerbo GX
- Power cable with inline fuse and M8 terminal eyes for battery or DC busbar-attachment.
- VE.Can terminators (2 pcs)
- Terminal Blocks for all the connectors on each side.
- [Watch this Video](#) for an unboxing and overview of the interfaces.

[https://www.youtube.com/embed/3wheKaU2\\_qw](https://www.youtube.com/embed/3wheKaU2_qw)



## 2. Installation

### 2.1. Overview of connections

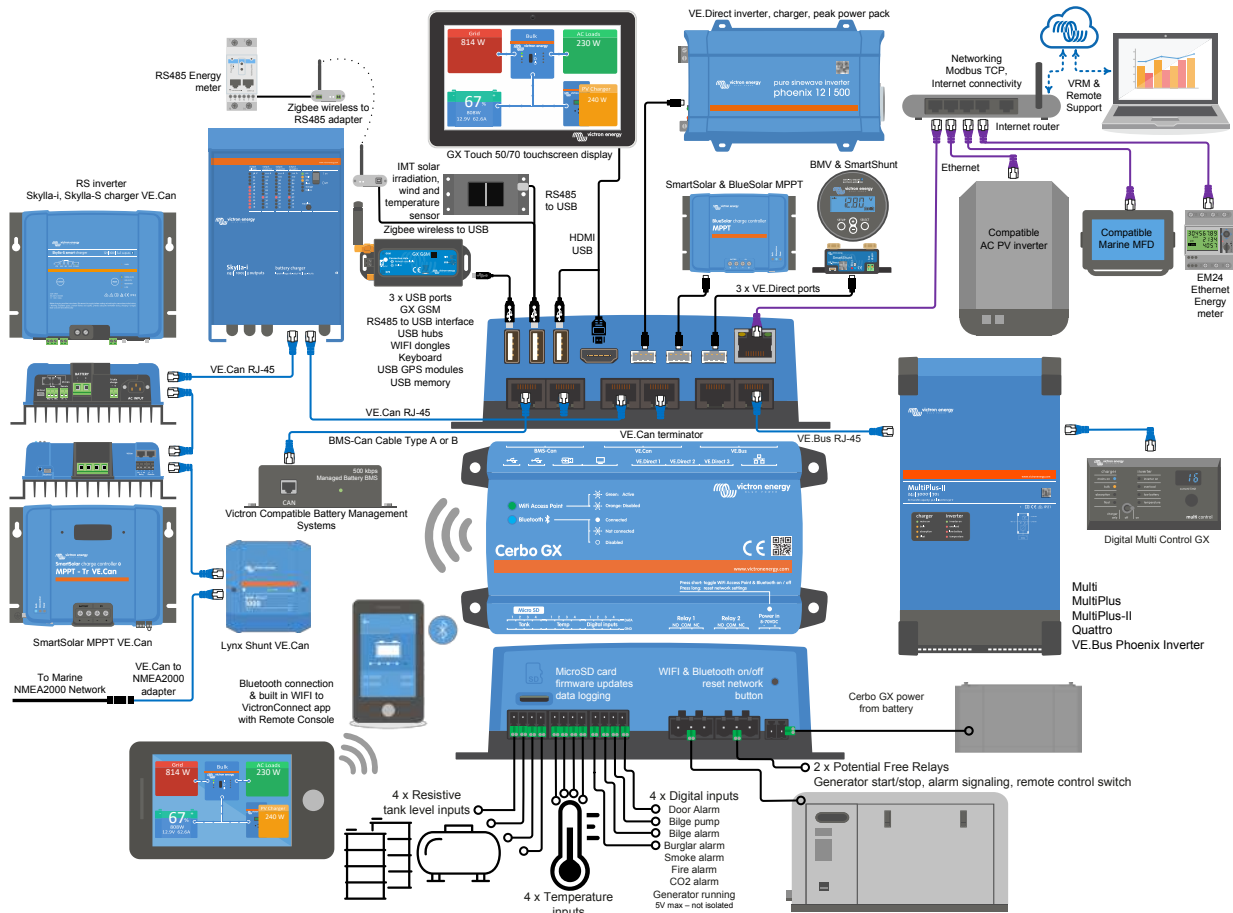

On the Cerbo GX, the USB socket closest to the HDMI connector can only be used to power a GX Touch. That USB port can **not** be used for any data related functions such as VE.Direct to USB cables, USB-sticks, USB-GPS-es, or other common USB usages. It's a power port only, no data.

### 2.2. Power

The device is powered by using the *Power in V+* connector. It accepts 8 to 70 V DC. The device will not power itself from any of the other connections (eg network). The supplied DC power cable includes an inline 3.15 A slow blow fuse.

If the DC voltage exceeds 60V, the Cerbo GX is classified as a "built-in product". Installation should be in such a way the user cannot touch the terminals.

When the Cerbo GX is used in an installation with a VE.Bus BMS, connect the *Power in V+* on the Cerbo GX to the terminal labelled '*Load disconnect*' on the VE.Bus BMS. Connect both negative leads to the negative stub of a common Battery.

#### A Cautionary word about Powering from the AC-out terminal of a VE.Bus Inverter, Multi or Quattro:

If you power the Cerbo GX from an AC adaptor connected to the AC-out port of any VE.Bus product (Inverter, Multi or Quattro), then a deadlock will occur after the VE.Bus products are powered-down for any reason (after any operational fault or during a black start). The VE.Bus devices will not boot-up until the Cerbo GX has power ...but the Cerbo GX will not boot-up until *it* has power. This deadlock can be rectified by briefly unplugging the Cerbo GX VE.Bus cable at which point you will observe the VE.Bus products will immediately begin to boot-up.

Or a modification can be done to the RJ45 cabling. See [FAQ Q20 \[94\]](#) for more information about this.

Note that both with or without above modification, powering the monitoring equipment with the AC-out of an inverter/charger (ofcourse) has the disadvantage that all monitoring is shut down when there is a problem that causes the inverter/charger to shut down. Examples are Inverter overload, high temperature or low battery voltage. It is therefore recommended to power the GX device from the battery.

### Isolation

Because the Cerbo GX is connected to many different products, please ensure that proper care is taken with isolation to prevent ground loops. In 99% of installations this will not be a problem.

- The VE.Bus ports are isolated
- The VE.Direct ports are isolated
- The VE.Can ports are not isolated.
- The USB ports are not isolated. Connecting a Wi-Fi Dongle or GPS Dongle will not create a problem as it is not connected to another power supply. Even though there will be ground loop when you mount a separately-powered USB hub, during extensive testing we have not found that it caused any issues.
- The Ethernet port is isolated, except for the shield: use unshielded UTP cables for the Ethernet network

### Extending USB ports by use of a self-powered USB hub

Although the number of USB ports can be extended by using a hub, there is a limit to the amount of power that the *onboard USB port* can provide. When extending the number of USB ports, we recommend you always use *powered* USB hubs. And to minimize the chance of issues, be sure to use good-quality USB hubs. As Victron also offers a VE.Direct to USB adapter, you can use this arrangement to increase the number of VE.Direct devices you can connect to your system, [please see this document](#) for the limit of how many devices can be attached to various different GX devices.

## 2.3. Mounting options and accessories

<https://player.vimeo.com/video/706533134#t=5m47s>

## 2.4. Connecting Victron products

### 2.4.1. Multis/Quattros/Inverters (VE.Bus products)

In order to keep this document short we are going to refer to all Multis, Quattros and Inverters as *VE.Bus* products.

The earliest version of the VE.Bus devices which can be connected to the Cerbo GX is 19xx111 or 20xx111, which were released in 2007. VE.Bus firmware 26xxxxx and 27xxxxx are also supported ...but 18xxxxx is not.

Note that for Multis, Quattros and EasySolars, it is not possible to use the Remote On/Off (header on the VE.Bus control PCB) in combination with a Cerbo GX. There should be wire between the left and middle terminal, as it is when shipped from the factory. In case a wired switch that disables the system is required, use the [Safety Switch Assistant](#) instead.

This limitation does not apply to the next generation of VE.Bus inverter/chargers: when using a MultiPlus-II, Quattro-II or EasySolar-II, the Remote on/off terminal header \*can\* be used in combination with Cerbo GX.

#### Single VE.Bus products

To connect a single VE.Bus product, connect it to one of the VE.Bus sockets on the back of the Cerbo GX. Both sockets are identical, use either one. Use a standard RJ45 UTP cable, see our [pricelist](#).

#### Parallel, split- and three-phase VE.Bus systems

To connect multiple VE.Bus products, configured as a parallel, split-phase or three phase VE.Bus system, connect either the first or the last VE.Bus product in the chain to either one of the VE.Bus sockets on the back of the Cerbo GX. Use a standard RJ45 UTP cable, see our [pricelist](#).

#### VE.Bus systems with Lithium batteries and a VE.Bus BMS

- Connect the Cerbo GX to the socket labelled 'MultiPlus/Quattro', or to one of the Multis/Quattros in the system. Do not connect it to the *Remote panel* socket on the VE.Bus BMS.
- Note that it will not be possible to control the On/Off/Charger Only switch. This option is automatically disabled in the Cerbo GX menu when a VE.Bus BMS is used. The only way to control a Multi or Quattro when used with a VE.Bus BMS is to add a Digital Multi Control to the system. Setting the input current limit is possible in systems with a VE.Bus BMS.
- Combining MultiPlus/Quattro with a VE.Bus BMS and a Digital Multi Control is possible. Simply connect the Digital Multi Control to the RJ-45 socket on the VE.Bus BMS labelled *Remote panel*.



- To allow auto-power-down in the Cerbo GX in case of a low battery, make sure the Cerbo GX is powered via the VE.Bus BMS: connect *Power in V+* on the Cerbo GX to *Load disconnect* on the VE.Bus BMS. And connect both negative leads to the negative stub of a common Battery.

#### **Combining the Cerbo GX with a Digital Multi Control**

It is possible to connect both a Cerbo GX and a Digital Multi control to a VE.Bus system. The ability to switch the product On, Off or set it to Charger Only via the Cerbo GX will be disabled. The same applies to the input current limit: when there is a Digital Multi Control in the system, the input current limit which is set at that control panel will be the master-setting, and changing it on the Cerbo GX will not be possible.

#### **Connecting multiple VE.Bus systems to a single Cerbo GX**

Only one VE.Bus system can be connected to the VE.Bus ports on the back of the Cerbo GX. The professional way to monitor more systems is to add a second Cerbo GX

If you do require to connect more than one system to the same Cerbo GX, use an MK3-USB. Functionality will be limited:

- Only the system connected to the built-in VE.Bus ports is used to generate the data on the Overview pages.
- All connected systems will be visible on the Device-list
- All connected systems will be taken into account for Energy consumption and distribution calculations (kWh graphs on VRM)
- Only the system connected to the built-in VE.Bus ports is used for the Generator start/stop logic
- In case of an ESS system, only the system connected to the built-in VE.Bus ports is used in the ESS mechanisms. The other one is displayed in the device list only.

Alternatively the VE.Bus to VE.Can interface (ASS030520105) can be used. Add one for each additional system. Note that we advise against it; this interface is a deprecated product. Make sure that the VE.Can network is terminated and powered. For powering the VE.Can network, see Q17 in our [data communication whitepaper](#).

#### **Additional features provided by a GX device to VE.Bus products**

An internet connected GX device allows for remote configuration via the VRM Portal. Please read the [Remote VE.Configure manual](#) for more information, system requirements and specific steps to access this feature.

### **2.4.2. Battery Monitor SmartShunt, BMV-700 series; and MPPTs with a VE.Direct port**

Direct connection via a VE.Direct cable is limited to the number of VE.Direct ports on the device (see [Overview of Connections \[2\]](#)). There are two types of VE.Direct cable available:

1. Straight VE.Direct cables, ASS030530xxx
2. VE.Direct cables with an angled connector on one end. These are designed to minimize the required depth behind a panel, ASS030531xxx

VE.Direct cables have a maximum length of 10 metres. It is not possible to extend them. If longer lengths are required, use a VE.Direct to USB adapter with an active USB extension cable.

It is also possible to use the VE.Direct to VE.Can interface, but note that this only works for BMV-700 and BMV-702. Not for the BMV-712, MPPT solar chargers and Inverters with a VE.Direct port. See next paragraph for more information on that VE.Can interface.

#### **Connecting more VE.Direct devices to your Cerbo GX than number of VE.Direct Ports**

First of all, note that the maximum of VE.Direct devices that can be connected is GX device specific, and constrained by the CPU power. It may also be reduced for very complex systems, such as many AC PV inverters or synchronised inverter chargers, etc. So always allow some additional headroom in the design. How they are connected, so direct, via USB or hub does not change this maximum. See [here](#) for the maximum limit on all GX devices Devices.

For the Cerbo GX, this limit is 15.

Then, these are the options on how to connect more VE.Direct products than available VE.Direct ports:

- Option 1: Use the [VE.Direct to USB interface](#). The Cerbo GX has built-in USB ports (see [Overview of Connections \[2\]](#)). Use a USB-hub when additional USB ports are required.
- Option 2: (Only!) the BMV-700 and BMV-702 can also be connected using the [VE.Direct to VE.Can interface](#). Note that the BMV-712, MPPTs and VE.Direct Inverters cannot be connected using this CAN-bus interface as it does not translate their data into CAN-bus messages. When using the VE.Direct to VE.Can interface, make sure that the VE.Can network is terminated, and also powered. For powering the VE.Can network, see Q17 in our [data communication whitepaper](#). Lastly, note that this CAN-bus interface is deprecated.

#### **DC Load Monitor Mode**

If you wish to use a SmartShunt or BMV-712 to monitor individual DC circuits, rather than as a whole-of-system battery monitor you can change the Monitor mode setting from Battery Monitor to DC Energy Meter in VictronConnect.

If DC meter is selected, you can select the following types (also in VictronConnect);

Solar charger, Wind charger, Shaft generator, Alternator, Fuel cell, Water generator, DC/DC charger, AC charger, Generic source, Generic load, Electric drive, Fridge, Water pump, Bilge pump, DC system, Inverter, Water heater

Once connected to a GX device, the type, and the amps and power of the DC load is shown in the user interfaces and available on the VRM Portal.

When configured as type "DC System", the GX does more than just recording and visualisation:

1. the power shown in the DC system box is the sum of power reported by all SmartShunts configured as such. Allowing multiple meters is done to accommodate for example a catamaran, so you can measure the DC Systems on Port hull and on Starboard hull.
2. the DC System Current is being compensated for when setting DVCC charge current limits to Multis, Quattros and Solar Chargers. For example when a load of 50A is being measured, and CCL by the battery is 25A, the limit given to the Multis & Solar Chargers is 75A. An improvement for systems with significant DC loads such as Yachts, Coaches and RVs.

Notes and limitations: (A) this feature is available for SmartShunts and BMV-712. Not for BMV-700 or BMV-702.

(B) Setting the meter mode is done with VictronConnect, in the BMV/SmartShunt itself.

(C) The NMEA2000-out feature does not support these new types, for example when using a SmartShunt to measure output of an alternator, that data is not made available on NMEA2000.

#### Notes about older VE.Direct MPPTs

- An MPPT 70/15 needs to be from year/week 1308 or later. Earlier 70/15s are not compatible with the Cerbo GX, and unfortunately upgrading the MPPT firmware will not help. To find the year/week number of your model, look for the serial number which is printed on a label on its back. For example number HQ1309DER4F means 2013, week 09.

### 2.4.3. VE.Can Devices

To connect a product with a VE.Can port, use a standard [RJ45 UTP cable](#) (available with straight and elbow connectors).

Don't forget to terminate the VE.Can network at both ends using a [VE.Can terminator](#). A bag with two terminators is supplied with each VE.Can product. They are also [available separately](#).

Other notes:

1. In order to work with the Cerbo GX an MPPT 150/70 needs run firmware v2.00 or newer.
2. You can combine a Skylla-i control panel with a Cerbo GX.
3. You can combine a Ion Control panel with a Cerbo GX.
4. All VE.Can devices power the VE.Can network, so it won't be necessary to power the VE.Can network separately in these circumstances. All the protocol converters, for example the VE.Bus to VE.Can interface; and the BMV to VE.Can interface, do not power the VE.Can network.

The following products also support [VictronConnect-Remote](#) monitoring and configuration:

- Lynx Shunt VE.Can and Lynx Smart BMS
- Multi RS, Inverter RS and MPPT RS
- Skylla-i and Skylla-IP44/IP65 (requires firmware v1.11)
- all VE.Can solar chargers except the very old (big rectangular case with display) BlueSolar MPPT VE.Can 150/70 and 150/85

### 2.4.4. VE.Can and BMS-Can Interfaces

The Cerbo GX has two CANbus interfaces. They are independent from a data and connected device perspective. They are not electrically isolated. One is labelled VE.Can, the other is labeled BMS-Can, with a screen print on the top side of the unit when it is facing towards you. These each correspond to the 'VE.Can port' and BMS-Can port' listed in the services menu of the GX software.

By default; VE.Can is set to 250 kbit/s & BMS-Can (if present) is set to 500 kbit/s

VE.Can is intended to be used for the Victron (and Victron compatible) VE.Can products, such as the VE.Can MPPTs, and VE.Can Lynx Shunt. You can string these VE.Can 250 kbit/s devices together along this bus. It must be terminated at both ends with the included VE.Can terminators.

BMS-Can is intended to be used with compatible managed battery systems, such as Pylontech, BYD, Freedomwon and many more. These must be terminated at the Victron end (on the Cerbo GX) with the included terminator (same one as used with

VE.Can). It may or may not be necessary to terminate at the managed battery, BMS or BMU - this will be documented in the specific Victron Compatible managed battery instructions for that battery. Some batteries automatically terminate.

You can't mix VE.Can and BMS-Can on the same bus. If you wish to use both, they require a GX device with two separate buses, each with 2 RJ45 ports - 4 CANbus ports in total.

You cannot set BMS-Can ports to anything other than 500 kbit/s, and disabled.

You CAN set the VE.Can port from 250 kbit/s to be 500 kbit/s (or one of several other CANbus speeds for other CANbus applications).

Other types of Batteries and BMS may claim compatibility with BMS-Can, or VE.Can, but if they are not on the [battery compatibility list](#) then they have not been tested and confirmed to work by Victron.

One extra element of possible confusion is that there ARE some BMS products on the market that use a CANbus BMS profile at 250 kbit/s.

These can only be connected to the VE.Can port, and it must also be set to match this (VE.Can & CAN-bus BMS (250 kbit/s)) in the services menu for the VE.Can port.

These BMS can be used in the same cable daisy chain as other Victron VE.Can devices.

#### 2.4.5. Inverter RS, Multi RS and MPPT RS

The Inverter RS, Inverter RS Solar and Multi RS have both VE.Direct and VE.Can interfaces. For these specific products, it is only possible to connect a GX device via the VE.Can interface, and it is not possible to connect a GX device via the VE.direct interface.

The VE.Direct interface on these specific products is only used for connection of a VE.Direct to USB adapter for programming.

This restriction does not apply to the MPPT RS, which can be connected to a GX device via either VE.Direct or VE.Can.

#### 2.4.6. BMV-600 series

Connect the BMV-600 using the VE.Direct to BMV-60xS cable. (ASS0305322xx)

#### 2.4.7. DC Link box

Connect the [DC Link box](#), using the RJ-12 cable supplied. Then connect the BMV-700 to the Cerbo GX - see connecting BMV-700 for more instructions.

#### 2.4.8. VE.Can Resistive Tank Sender Adapter

See its [page and manual on our website](#) for details about the Adapter.

To connect a product with a VE.Can port, use a [standard RJ45](#) UTP cable.

Don't forget to terminate the VE.Can network on both ends using a [VE.Can terminator](#). A bag with two terminators is supplied with each VE.Can product. They are also [available separately](#) (ASS030700000). (Available with straight or elbow connectors.)

Make sure that the CAN-bus is powered, see the [Power chapter in the Tank Sender Adapter manual](#) for details.

### 2.5. Connecting a PV Inverter

Measuring the output of a PV Inverter will provide the user with an overview of both actual power balance and the energy distribution. Note that these measurements are only used to display information. They are not needed, nor used, by the installation for its performance. Besides monitoring, the GX device can also curtail some types and brands of PV Inverters, ie. reduce their output power. This is used, and required, for the [ESS Zero or limited feed-in feature](#).

#### Direct connections

Type	Zero feed-in	Details
Fronius	Yes	LAN Connection, see <a href="#">GX - GX - Fronius manual</a>
SMA	No	LAN Connection, see <a href="#">GX - GX - SMA manual</a>
SolarEdge	No	LAN Connection, see <a href="#">GX - SolarEdge manual</a>
ABB	Yes	LAN Connection, see <a href="#">GX - ABB manual</a>

**Using a meter** For PV Inverters that cannot be interfaced digitally, a meter can be used:

Type	Zero feed-in	Details
AC Current Sensor	No	Connected to inverter/charger analog input. Lowest cost - least accurate. <a href="#">Energy Meter</a>
Energy Meter	No	Wired to the Cerbo GX, or connected wirelessly using our Zigbee to USB/RS485 interfaces. See the <a href="#">Energy Meters start page</a>
Wireless AC sensors	No	See the <a href="#">Wireless AC Sensor manual</a> - Discontinued

## 2.6. Connecting a USB GPS

Use a GPS to remotely, on the VRM Portal, track vehicles or boats. Also its possible to configure a Geofence, which will automatically send an alarm when the system leaves a designated area. And gps-tracks.kml files can be downloaded, to for example open in Navlink and Google Earth.

Victron does not sell USB-GPS, but the Cerbo GX will support third-party GPS modules which use the NMEA0183 command-set - almost all do. It can communicate at both 4800 and 38400 baud rates. Plug the unit into either of the two USB sockets ... connection may take a few minutes, but the Cerbo GX will automatically recognize the GPS. The unit's location will automatically be sent to the VRM online portal and its position shown on the map.

The Cerbo GX has been tested for compatibility with:

- Globalsat BU353-W SiRF STAR III 4800 baud
- Globalsat ND100 SiRF STAR III 38400 baud
- Globalsat BU353S4 SiRF STAR IV 4800 baud
- Globalsat MR350 + BR305US SiRF STAR III 4800 baud

## 2.7. Connecting a NMEA 2000 GPS

Use a GPS to remotely, on the VRM Portal, track vehicles or boats. Also its possible to configure a Geofence, which will automatically send an alarm when the system leaves a designated area. And gps-tracks.kml files can be downloaded, to for example open in Navlink and Google Earth.

The third party NMEA 2000 GPS sender must meet the following requirements:

- The NMEA 2000 device class must be 60, Navigation.
- The NMEA 2000 device function must be 145, Ownship Position (GNSS).
- Position (latitude, longitude) must be transmitted in either PGN 129.025.
- Height, which is optional, must be transmitted in PGN 129.029.
- Course and speed (both optional), must be transmitted in PGN 129.026

Most NMEA 2000 GPS-es are expected to work. Compatibility has been tested with:

- Garmin GPS 19X NMEA 2000

To connect a NMEA 2000 network to the VE.Can port on the GX device, which both have a different style connector, there are two solutions:

1. The [VE.Can to NMEA2000 cable](#). Which by either inserting or leaving out the fuse allows to either power the NMEA2000 network with Victron equipment, or not. Take note of below warning.
2. The [3802 VE.Can Adapter by OSUKL](#). Its advantage is that it lends itself well to connecting a single NMEA-2000 device such as a tank sender into a VE.Can network. It's also able to power a lower voltage NMEA-2000 network directly from a 48V Victron system.

### Warning and solution for 24V and 48V systems

Whilst all Victron components accept up to 70V input on their CAN-bus connections, some NMEA 2000 equipment does not. They require a 12V powered NMEA 2000 connection, and sometimes work up to 30 or 36V. Make sure to check the datasheet of all used NMEA 2000 equipment. In case the system contains NMEA 2000 that requires a network voltage below the battery voltage, then either see above 3802 VE.Can Adapter by OSUKL. Or alternatively install the VE.Can to NMEA 2000 cable without it's fuse, and provide suitable power to the NMEA 2000 network using for example a NMEA 2000 power adapter cable – which is not supplied by Victron. The VE.Can port on the GX Device does not need external power to operate.

## 2.8. Connecting a Fischer Panda Generator

See [GX - Fischer Panda generators](#).

## 2.9. Connecting a GX Tank 140

The GX Tank 140 is an accessory for our range of GX system monitoring products.



It takes readings from up to four tank level sensors.

Tank levels can be read-out locally in the system, as well remotely through our VRM Portal.

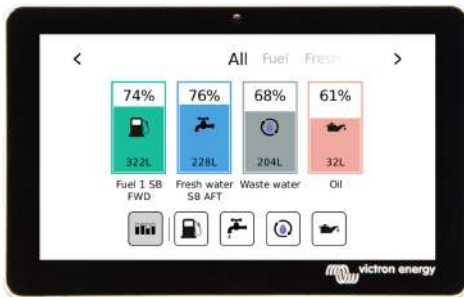

The GX Tank 140 is compatible with current senders (4 to 20 mA) as well as voltage senders (0 to 10 V). The connection to the GX Device is via USB, which is also how the GX Tank is powered: no additional power wires required.

To make wiring the tank sender as simple as possible, two of the four inputs provide a 24 V power supply, to power the sender. Using the other two channels requires an external power supply, and there is a power in terminal together with fused outputs to facilitate that.

Upper and lower limits are configurable, to allow using senders that provide only part of the scale, for example 0 to 5 V.

For marine applications, the GX Device can transmit these tank levels on the NMEA 2000 network to be picked up by other displays such as an MFD.

The [GX Tank 140 product page](#) links to the complete documentation of this product.

## 2.10. Connecting Tank Level Sensors

See the [Connection Overview \[2\]](#) for the location and number of tank level sensor inputs.

The tank level inputs are resistive and should be connected to a resistive tank sender. Victron does not supply tank senders. The built-in tank sensor connections do not support mA or 0-5V type sensors, this type will require additional accessories or replacement with a resistive type sensor.

Sensors are enabled (and disabled) in the I/O menu of the GX device settings. Once enabled, the tank will appear in the GX menu with options to customise the setup to suit your specific installation.

Set the tank volume unit (Cubic meter, litre, imperial or U.S gallon), and capacity. It is also possible to configure custom shapes for non-linear tanks, with up to 10 variations e.g 50% of sensor is equal to 25% of volume & 75% of sensor is equal to 90% of volume.

The tank level ports can each be configured to work with either European (0 - 180 Ohm); or US tank senders (240 - 30 Ohm) standards; or to configure a custom Ohm resistance range between 0 Ohm and 300 Ohm (requires firmware v2.80 or higher).

You can set tank fluid type to Fuel, fresh water, waste water, live well, oil, blackwater (sewage) and also set a custom name.

Tank level data is sent to VRM, shown on the boat and motorhome overview displays (if connected and enabled), and can be used as a trigger for the relay when it is set to 'tank pump'.

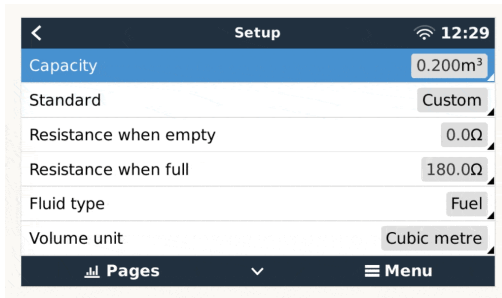

To physically attach the tank probes requires a ferrule or exposed copper end of at least 10 mm+ to be inserted into the removable terminal block connector. Once correctly attached, you must use the orange tab if you wish to remove the secured wire.

## 2.11. Connecting third-party NMEA 2000 tank senders

A third party NMEA 2000 tank sender must meet the following requirements to be visible on the GX Device:

- Transmit the NMEA 2000 Fluid Level PGN, 127505
- The NMEA 2000 device class needs to either General (80) in combination with function code Transducer (190), or Sensor (170). Or, the NMEA 2000 device class needs to be Sensors (75), in combination with function Fluid Level (150).

A single function reporting multiple Fluid Levels is currently not supported.

For some tank senders it is also possible to configure the capacity and the fluid type on the GX Device menus - for example the Maretron TLA100. This facility may be available with other senders made by other manufacturers - it's well-worth trying.

Tested compatible NMEA2000 tank senders:

- Maretron TLA100
- Maretron TLM100
- Navico Fluid Level Sensor Fuel-0 PK, partno. 000-11518-001. Note that you need a Navico display to configure the Capacity, Fluid type, and other parameters of the sensor. **See voltage warning below.**
- Oceanic Systems (UK) Ltd (OSUKL) - 3271 Volumetric Tank Sender. In case it doesn't work, it needs a firmware update. Contact OSUKL for that. **See voltage warning below.**
- Oceanic Systems UK Ltd (OSUKL) - 3281 Water Level Sender. **See voltage warning below**

Most likely others work as well. If you know of one working well, please edit this page -or- get in touch with us on [Community -> Modifications](#).

To connect an NMEA2000 network to the VE.Can port on the GX device, which both have different type connectors, there are two solutions:

1. The [VE.Can to NMEA2000 cable](#). Which by either inserting or leaving out the fuse allows to either power the NMEA2000 network with Victron equipment, or not. Take note of below warning.
2. The [3802 VE.Can Adapter by OSUKL](#). Its advantage is that it lends itself well to connecting a single NMEA-2000 device such as a tank sender into a VE.Can network. It's also able to power a lower voltage NMEA-2000 network directly from a 48V Victron system.

### Warning and solution for 24V and 48V systems

Whilst all Victron components accept up to 70V input on their CAN-bus connections, some NMEA2000 equipment does not. They require a 12V powered NMEA2000 connection, and sometimes work up to 30 or 36V. Make sure to check the datasheet of all used NMEA2000 equipment. In case the system contains NMEA2000 that requires a network voltage below the battery voltage, then either see above 3802 VE.Can Adapter by OSUKL. Or alternatively install the VE.Can to NMEA2000 cable without it's fuse, and provide suitable power to the NMEA2000 network using for example a NMEA-2000 power adapter cable – which is not supplied by Victron. The VE.Can port on the GX Device does not need external power to operate.

## 2.12. Connecting Temperature Sensors

### 2.12.1. Hardwired sensors

See the [Connection Overview \[2\]](#) for the location and number of temperature sensors.

They can be used to measure & monitor all kinds of temperature-inputs.

Temperature senders are not included. The required sensor is [ASS000001000 - Temperature Sensor QUA/PMP/Venus GX](#).

(Note that this is different to the BMV temperature accessory.)

They are not required to be connected to the battery (though they appear like a battery lug).

To physically attach the temperature probes requires a ferrule or exposed copper end of at least 10 mm+ to be inserted into the removable terminal block connector. Once correctly attached, you must push in the orange tab if you wish to remove the secured wire.

Sensors are connected with the red wire to the top of the connector, and the black wire to the bottom.



Sensors are enabled (and disabled) in the Settings -> I/O -> Analog inputs menu of the GX device settings.

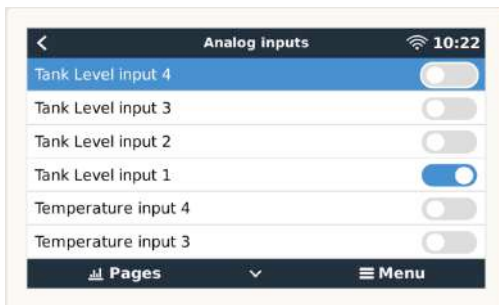

Once enabled, temperature sensor data is visible in the device list, and also logged to VRM.

Selecting the temperature sensor from the device list menu then allows you to Setup the Temperature Type setting to either Battery, Fridge or Generic. It is also possible to set a custom name in the Device menu.

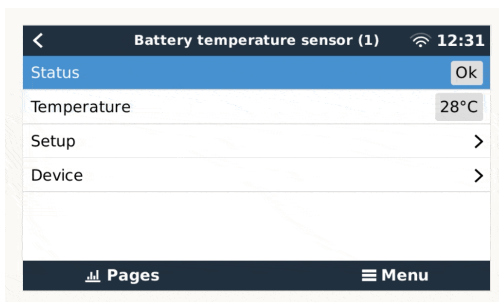

It is possible to adjust the temperature offset and scale, however for now this feature is limited to users with 'superuser' permission level.



### 2.12.2. Wireless bluetooth Ruuvi sensors

The Ruuvi sensor features temperature, humidity and atmospheric pressure streamed wirelessly to the GX device.

The Cerbo GX built-in bluetooth connection is disabled when the internal CPU temperature exceeds 53 degrees C (influenced by load and/or ambient temperature). **For reliable operation it is necessary to use a USB Bluetooth adapter.**

USB Bluetooth adapters that have been tested and known to work:

- Insignia (NS-PCY5BMA2)
- Logilink BT0037
- TP-Link UB400(UN)
- Ewent EW1085R4
- Laird BT820
- Laird BT851
- Kinivo BTD-400
- Ideapro USB bluetooth adapter 4.0

A list of additional adapters that are also being tested, as well as adapters that have been tested and are known not to work, is available here: <https://community.victronenergy.com/questions/112834/connect-ruuvi-to-ccgx.html>

#### Installation procedure

Make sure that Bluetooth is enabled in the bluetooth menu (enabled by default)

Go to Settings → I/O → Bluetooth sensors menu, then Enable to enable bluetooth temperature sensors.

The Ruuvi sensors come supplied with a removable plastic pull tab. This prevents it from discharging while on the shelf. Pull out the plastic tab and the unit will start transmitting its temperature information.



The sensor should appear in the menu, "Ruuvi ####" - with a 4 hexadecimal device ID, enable the specific Ruuvi sensor.



The Bluetooth adapters submenu displays a list of available Bluetooth adapters. The menu option Continuous scanning permanently scans for new Bluetooth sensors.





If you have multiple sensors, you may wish to physically write this device ID on the sensor case itself to help keep track. The sensor should now be visible in the main menu - by default is labelled 'Generic temperature sensor (##)'

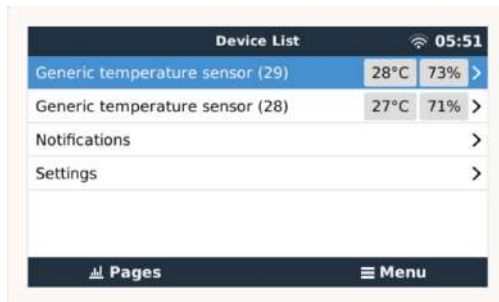

It is possible inside the temperature sensor menu to adjust the type, and also to set a custom name.

The Ruuvi sensors are estimated to last more than 12 months on a single replaceable CR2477 3V Li coin battery. Both the internal battery voltage and the battery status are displayed in the menu of the respective sensor. Status 'Ok' = battery voltage  $\geq 2.50V$ . Status 'Sensor battery low' = battery voltage  $\geq 2.50V$ .



It is possible to update the firmware for the Ruuvi with Ruuvi's own separate phone app, though this is not necessary unless you are experiencing issues.

## 2.13. Connecting IMT Solar Irradiance, Temperature and Wind Speed Sensors

### Compatibility

Ingenieurbüro Mencke & Tegtmeier GmbH (IMT) offer a range of digital silicon irradiance sensor models within the [Si-RS485 series](#) that are all compatible with a Victron GX device.

The optional/additional [external module temperature](#), [ambient temperature](#) and [wind speed](#) sensors are also supported.

Optional/additional external sensors are either connected to the solar irradiance sensor with pre-installed plugs or pre-wired to the solar irradiance sensor (external module and ambient temperature only). When external sensors are connected via an appropriate solar irradiance sensor, all measurement data is transmitted to the Victron GX device with the single interface cable.

Each model solar irradiance sensor within Si-RS485 series has a different capability with regards to external sensors (or comes with an external sensor pre-wired), so carefully consider any future desires/requirements before initial purchase.

It is also possible to connect an independent [IMT Tm-RS485-MB module temperature sensor](#) (visible as 'cell temperature') or [IMT Ta-ext-RS485-MB ambient temperature sensor](#) (visible as 'external temperature') directly to the Victron GX device, without a solar irradiance sensor or in addition to one.

### Operation

The IMT Si-RS485 series solar irradiance sensors operate using RS485 electrical interface and Modbus RTU communication protocol.

The Victron GX device must be running version 2.40 or later.

The IMT sensor needs to be firmware version 1.52 minimum - for more information about this please contact IMT.

Physical connection to the Victron GX device is via USB port and requires a Victron RS485 to USB interface cable.

A suitable external DC power source (12 to 28 VDC) is also required - the sensor is NOT powered via USB.

**Wiring Connections**

The schematic in the installation guide below depicts the wiring configuration in a typical installation.

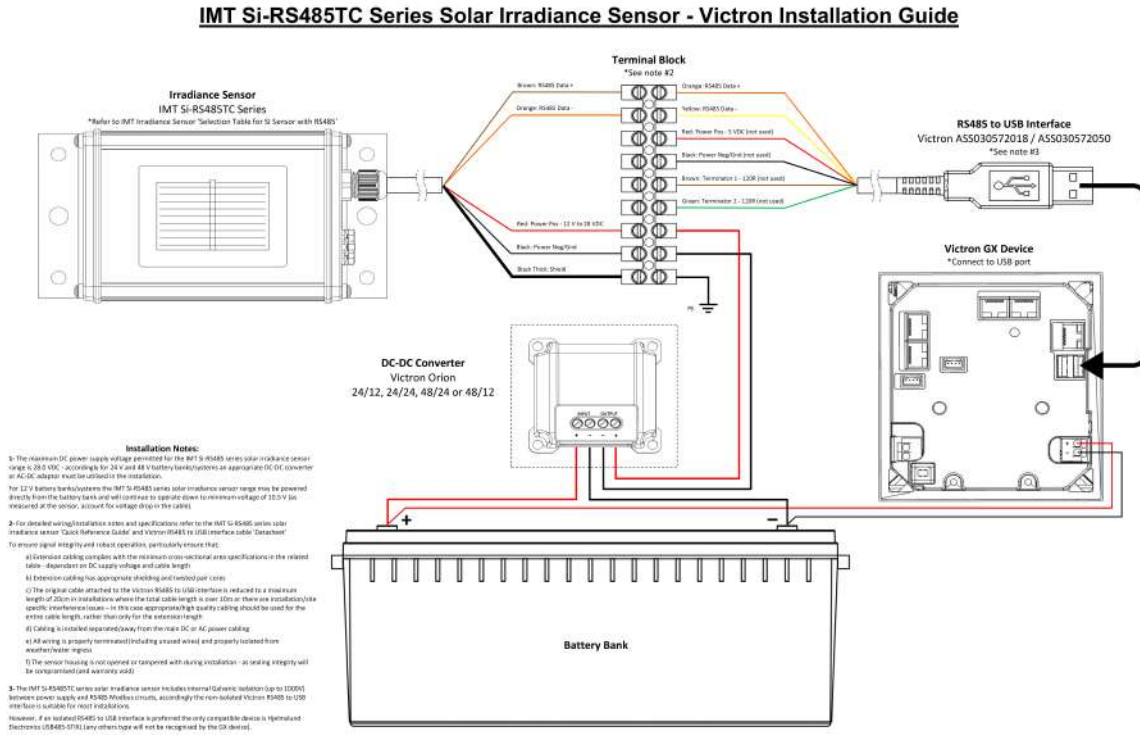

**Wire connections**

Si-Sensor	Victron RS485 to USB interface	Signal
Brown	Orange	RS485 Data A +
Orange	Yellow	RS485 Data B -
Red	-	Power Pos - 12 to 28 VDC
Black	-	Power Neg/Gnd - 0 VDC
Black (thick)	-	Ground / Cable Shield / PE
-	Red	Power Pos - 5 VDC (not used)
-	Black	Power Neg/Gnd - 0 VDC (not used)
	Brown	Terminator 1 - 120R (not used)
	Green	Terminator 2 - 120R (not used)

**Installation Notes**

The maximum DC power supply voltage permitted for the IMT Si-RS485 series solar irradiance sensor range is 28.0 VDC - accordingly for 24 V and 48 V battery banks/systems an appropriate Victron DC-DC converter (24/12, 24/24, 48/12 or 48/24) or AC-DC adaptor must be utilised in the installation.

For 12 V battery banks/systems the IMT Si-RS485 series solar irradiance sensor range may be powered directly from the battery bank and will continue to operate down to minimum voltage of 10.5 V (as measured at the sensor, account for voltage drop in the cable).

For detailed wiring/installation notes and specifications refer to the [IMT Si-RS485 series solar irradiance sensor 'Quick Reference Guide'](#) and [Victron RS485 to USB interface cable 'Datasheet'](#).

To ensure signal integrity and robust operation, particularly ensure that;

- Extension cabling complies with the minimum cross-sectional area specifications in the related table - dependent on DC supply voltage and cable length
- Extension cabling has appropriate shielding and twisted pair cores
- The original cable attached to the Victron RS485 to USB interface is reduced to a maximum length of 20cm in installations where the total cable length is over 10m or there are installation/site specific interference issues – in this case appropriate/high quality cabling should be used for the entire cable length, rather than only for the extension length
- Cabling is installed separated/away from the main DC or AC power cabling
- All wiring is properly terminated (including unused wires) and properly isolated from weather/water ingress
- The sensor housing is not opened or tampered with during installation - as sealing integrity will be compromised (and warranty void)

The IMT Si-RS485TC series solar irradiance sensor includes internal Galvanic Isolation (up to 1000V) between power supply and RS485 Modbus circuits, accordingly the non-isolated Victron RS485 to USB interface is suitable for most installations.

However, if an isolated RS485 to USB interface is preferred the only compatible device is [Hjelmstedt Electronics USB485-STIXL](#) (any others type will not be recognised by the GX device).

### Multiple Sensors

It is possible to connect multiple IMT Si-RS485 series solar irradiance sensors to a common Victron GX device, however a dedicated Victron RS485 to USB interface is required for each individual unit.

Multiple units cannot be combined on a single interface (as this is not supported by the related Venus OS software).

### Configuration

There is normally no need for any special/additional configuration – the default 'as shipped' configuration is compatible for communication with a Victron GX device.

However, in cases where the IMT Si-RS485 series solar irradiance sensor has been previously used in another system and/or the settings changed for any reason, it is necessary to restore the default configuration before further use.

To revise the configuration, download the [IMT 'Si-MODBUS-Configuration software tool'](#). Follow the instructions in the [IMT 'Si Modbus Configurator Documentation'](#) and check/update the following settings:

- MODBUS Address: 1
- Baud Rate: 9600
- Data Format: 8N1 (10 Bit)

For further support related to configuration of the IMT Si-RS485 Series irradiance sensors please contact IMT Solar directly.

### User Interface - GX Device

Upon connection to the Victron GX device and power up the IMT Si-RS485 Series irradiance sensor will be automatically detected within a few minutes and appear in the 'Device List' menu.

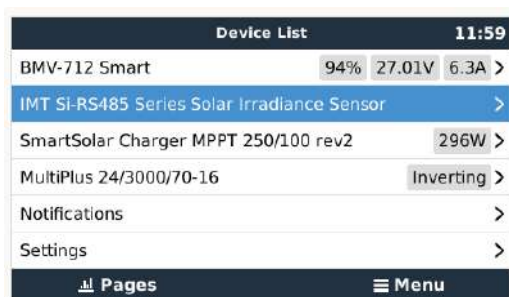

Within the 'IMT Si-RS485 Series Solar Irradiance Sensor' menu all available parameters will be automatically displayed (dependent on the sensors connected) and update in real time.

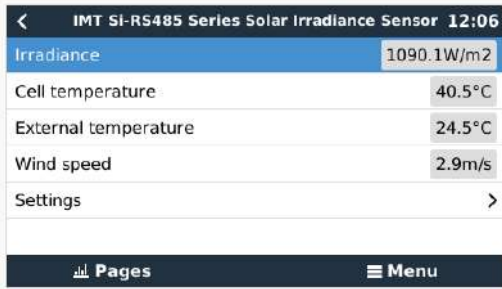

Within the 'Settings' sub-menu it is possible to manually enable and disable any optional/additional external sensors that are connected to the IMT Si-RS485 Series irradiance sensor.

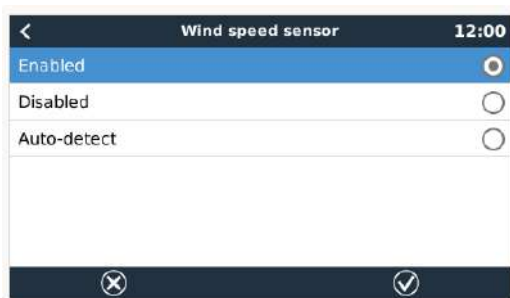
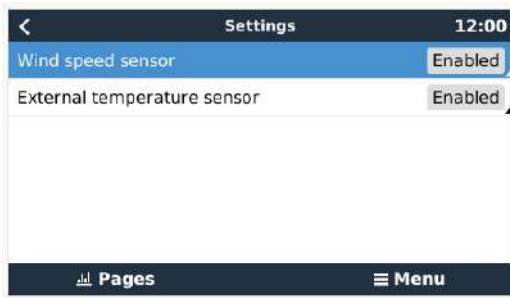

### 2.13.1. Data Visualisation - VRM

To review logged historical data on the VRM portal, expand the 'Meteorological Sensor' widget list and select the 'Meteorological Sensor' widget.



Data from all available sensor types will be automatically displayed in the graph. Individual sensors/parameters can also be disabled/enabled by clicking on the sensor name/legend.



## 2.14. Relay connections

The GX device has potential-free Normally Open (NO) and Normally Closed (NC) relay functionality. This can be programmed via the menu to operate under a variety of conditions.

Figure 1. Programmable relay wired to operate a load

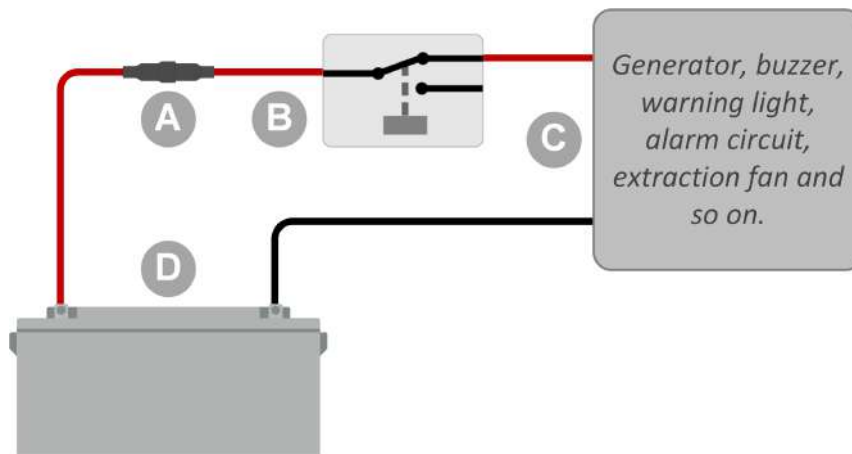

ID	Description
A	Fuse
B	Programmable relay
C	Generator, buzzer, warning light, alarm circuit, extraction fan and so on
D	Battery

**Figure 2. Programmable relay wired to operate as a potential free contact switch**

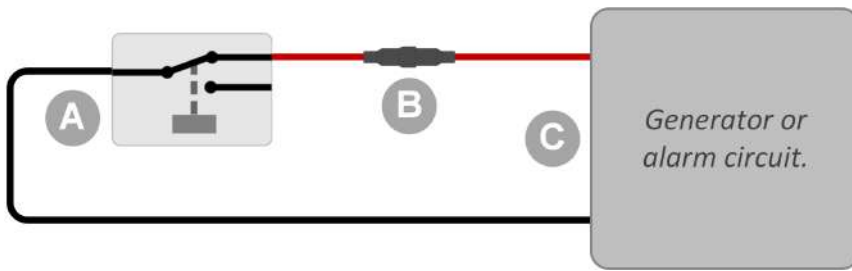

ID	Description
A	Programmable relay
B	Fuse
C	Generator or alarm circuit

## 2.15. AC load monitoring

All [energy meter types](#) can now be configured to a new "role": AC load monitor. This is done in the menu where you also choose between Grid, PV Inverter and Generator. With AC load monitor selected, the load will be shown in the Device list.

Please note that such metered loads are not used in any calculations, just monitoring.

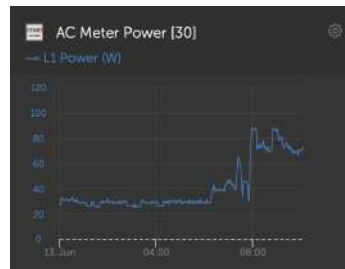

## 3. Internet connectivity

Connect the Cerbo GX to the internet to get all the advantages of the [VRM Portal](#). The Cerbo GX sends data from all connected products to the VRM portal - from where you can monitor energy usage, view the current status of connected products, configure [email alarms](#) and download data in CSV and Excel formats.

To monitor this data from your smartphone or tablet download the [iOS or Android VRM App](#).

In addition to remote monitoring, an active internet connection allows the Cerbo GX to regularly check for a new firmware versions - which will be automatically downloaded and installed.

There are several ways to connect a Cerbo GX to the internet:

- Run a network cable between a router and the Cerbo GX Ethernet LAN port
- Connect to the router wirelessly using WiFi
- Via the mobile (cellular) network, using the [GX GSM - a cellular USB modem](#) or, with a 3G or 4G router.
- USB Tethering on a mobile phone

This video explains how to connect LAN, WiFi and a GX GSM:

<https://www.youtube.com/embed/645QrB7bmvY>

### 3.1. Ethernet LAN port

When you connect an ethernet cable between a router and Cerbo GX, the Settings -> Ethernet page of your Cerbo GX will confirm connection.

Ethernet		23:39
State	Connected	
MAC address	90:59:AF:6A:16:EB	
IP configuration	Automatic	
IP address	192.168.003.167	
Netmask	255.255.255.000	
Gateway	192.168.003.001	

### 3.2. Wi-Fi

The Cerbo GX includes built in Wi-Fi. It is also possible to connect a supported external USB Wi-Fi dongle (to increase wireless range outside of a cabinet for example).

Using Wi-Fi it is possible to connect to WEP, WPA and WPA2 secured networks. There are five supported USB Wi-Fi dongles. Two of them are also available from stock at Victron Energy:

- Partno. BPP900100200 - Cerbo GX WiFi module simple (Nano USB), small, low cost.
- Partno. BPP900200300 - [Asus USB-N14](#), slightly higher cost and also better reception than the Nano USB. Supported since software version 2.23.
- Partno. BPP900200400GX - WiFi module long range (Netgear AC1200) - higher cost and also better reception than the Nano USB. Wireless AC, Wireless G and Wireless N; 2.4 Ghz and 5 Ghz.

WiFi modules that are no longer available, but still supported, are:

- Partno. BPP900200100 - [Startech USB300WN2X2D](#)
- Partno. BPP900100100 - [Zyxel NWD2105](#)
- Partno. BPP900200200 - [Gembird WNP-UA-002](#), slightly higher cost and also better reception.
- Partno. BPP900200400 - [Netgear A6210-100PES](#).

Although other Wi-Fi dongles may work, they have not been tested and we do not offer support for other dongles.

The Wi-Fi menu shows the available networks. When a network is selected, it is possible to fill in the password (if the password is not already known) to connect to the network. Setting up via WPS (Wi-Fi Protected Setup) is not supported.

When the Cerbo GX finds multiple Wi-Fi networks of which the password is known, the strongest network is selected automatically. When the signal of the connected network becomes too weak, it will automatically switch to a stronger network - if it knows the password of that network.

Wi-Fi is an inherently less reliable connection than a hardwired ethernet cable. It should always be a preference to connect via ethernet when possible. Signal strength should always be at least 50%.

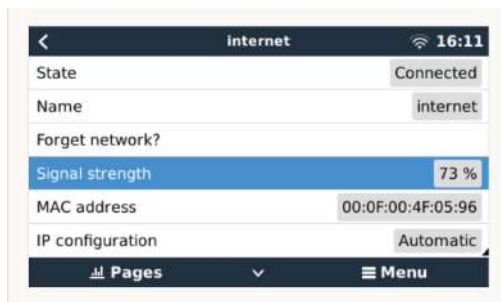

### 3.3. GX GSM

Please see the [GX GSM Manual](#).

### 3.4. Mobile (cellular) network using a 3G or 4G router

To connect the Cerbo GX to a mobile (cellular) network, such as a 3G or 4G network, use a cellular router. Connect the Cerbo GX to that router with either a LAN cable or the router's Wi-Fi network.

Make sure you use a router that is designed for unattended setups. Do not use low cost consumer-grade routers intended for business or leisure travel. A more expensive professional router will quickly pay for itself, and you won't have wasted journeys simply to perform a re-set. Examples of such professional routers are the [H685 4G LTE from Proroute](#), as well as the [Industrial 4G router range from Pepwave](#).

More information in [this blogpost](#).

Note that the Cerbo GX does not support USB 3G/4G dongles, other than the GX GSM and GX LTE 4G accessories available from Victron.

### 3.5. USB tethering using a mobile phone

This is a useful facility when it works - but don't rely on it because it has not proved very dependable. Consult the internet for instructions about tethering for your phone and its particular operating system. We have heard of it working on:

- Samsung Galaxy S4

...but not on:

- iPhone 5s with iOS 8.1.1

### 3.6. IP Configuration

Almost no installations will need the IP address configuration to be inserted manually as most systems support automatic IP configuration (DHCP) - and that is also the Cerbo GX default setting. If you do need to configure the address manually, select the following template:

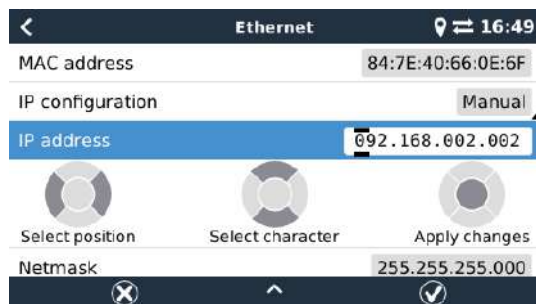

Complete details of IP requirements, as well as used port numbers will be found in the [VRM FAQ - ports and connections used by the \[93\] Cerbo GX](#)



### 3.7. Connecting both Ethernet and Wi-Fi (failover)

It is possible to connect the Cerbo GX to both Ethernet and Wi-Fi. In this case, the Cerbo GX will try to determine which interface provides an active internet connection and then use that interface. When both have an active internet connection, the Ethernet connection is used. The Cerbo GX will automatically check again for active internet connections when something changes on the interfaces.

### 3.8. Minimize internet traffic

In situations where internet traffic is expensive, for example a satellite uplink or with roaming GSM/cellular charges, you may want to minimize the internet traffic. The steps to take are:

- Disable auto-update
- Do not enable remote support
- Reduce the Logging interval to a very low frequency. Note that state changes (charging → inverting, or bulk→float) and also alarms will cause extra messages to be sent

To find out how much data allowance you need to buy the best way is to let the system run for a couple of days and monitor the internet RX and TX counters in your 3G or 4G router. Or even better, some mobile companies will report the data used via a website.

The amount of data used is also very dependent on the system:

More products connected to the Cerbo GX will generate more data.

- A state change (from inverter to charger for example) will trigger a data transmission, so a system with very frequent state changes will also tend to generate more data. This is especially true in certain Hub-1 and Hub-2 systems.

We recommend setting-up your data plan in such a way as to avoid costly 'excess' charges. Make sure you put a cap on your data usage; or use a pre-paid plan.

One customer - burdened with global costs of between twenty cents and several euros per mb of data - invented a clever solution: Using a VPN he modified the IP to route ALL traffic to and from the GX device via his VPN. Using a firewall at the VPN server allows him to control traffic according to time, connection type, place and destinations. Although this is beyond the scope of this manual it works, and - with the help of a Linux and networking expert - it can work for you.

### 3.9. More information about setting up an internet connection and VRM

- [Setting up a VRM account](#)
- [VRM Portal alarms and monitoring](#)
- [VRM Portal - Frequently asked questions](#)

## 4. Accessing the GX device

It is possible to access the GX device using either a smartphone, tablet or computer.

This access is called Remote Console. In GX devices with a display this Remote Console feature may be disabled by default and need to be enabled. GX devices without a display have Remote Console enabled by default.

There are several ways to get access:

- Using VictronConnect via Bluetooth
- By using the built-in WiFi Access Point
- Via the local LAN/WiFi network
- Through the online VRM Portal, which requires internet

### 4.1. Using VictronConnect via Bluetooth

If you are just getting started for the first time with VictronConnect, you may wish to begin with the [VictronConnect manual](#).

Load the [latest version of the VictronConnect app](#) onto your [bluetooth compatible device](#) (phone or laptop), and make sure that bluetooth is enabled.

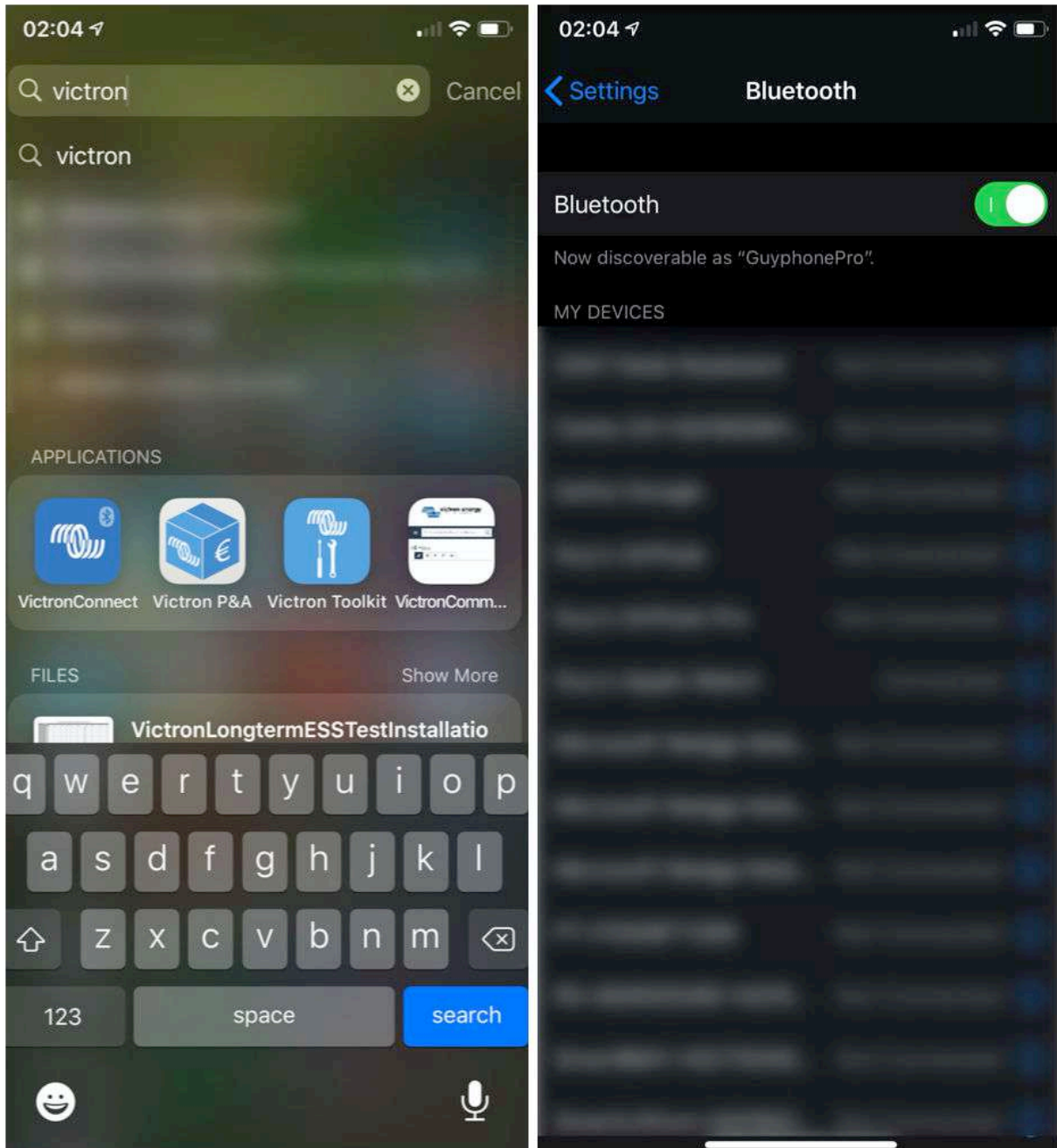

Make sure that the Cerbo GX is powered on, and the Bluetooth LED is blinking.

Open the VictronConnect App within 10 meters of the Cerbo GX and wait for nearby devices to be discovered.

Once discovered, Click or Tap on the Cerbo GX.

On first connection you will be asked to enter a bluetooth PIN code - the default PIN is 000000

You will then be asked to change this insecure default PIN code to a more secure unique code. Please set your unique code, and then put it in a safe place for passwords in case you forget.

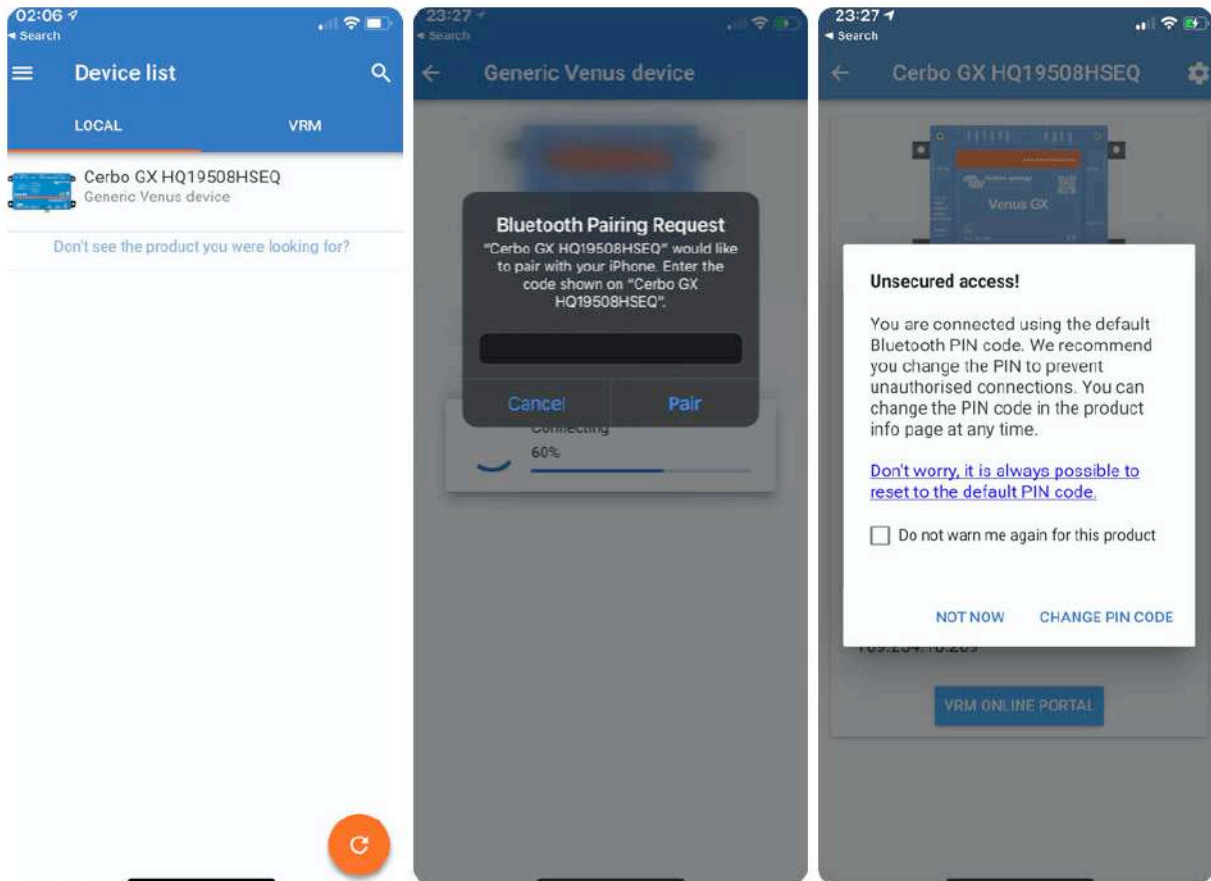

From the main device screen it is possible to change the networking settings, view the system on VRM, or open the Remote Console.

Network settings for the Cerbo GX are set in the Cog menu.

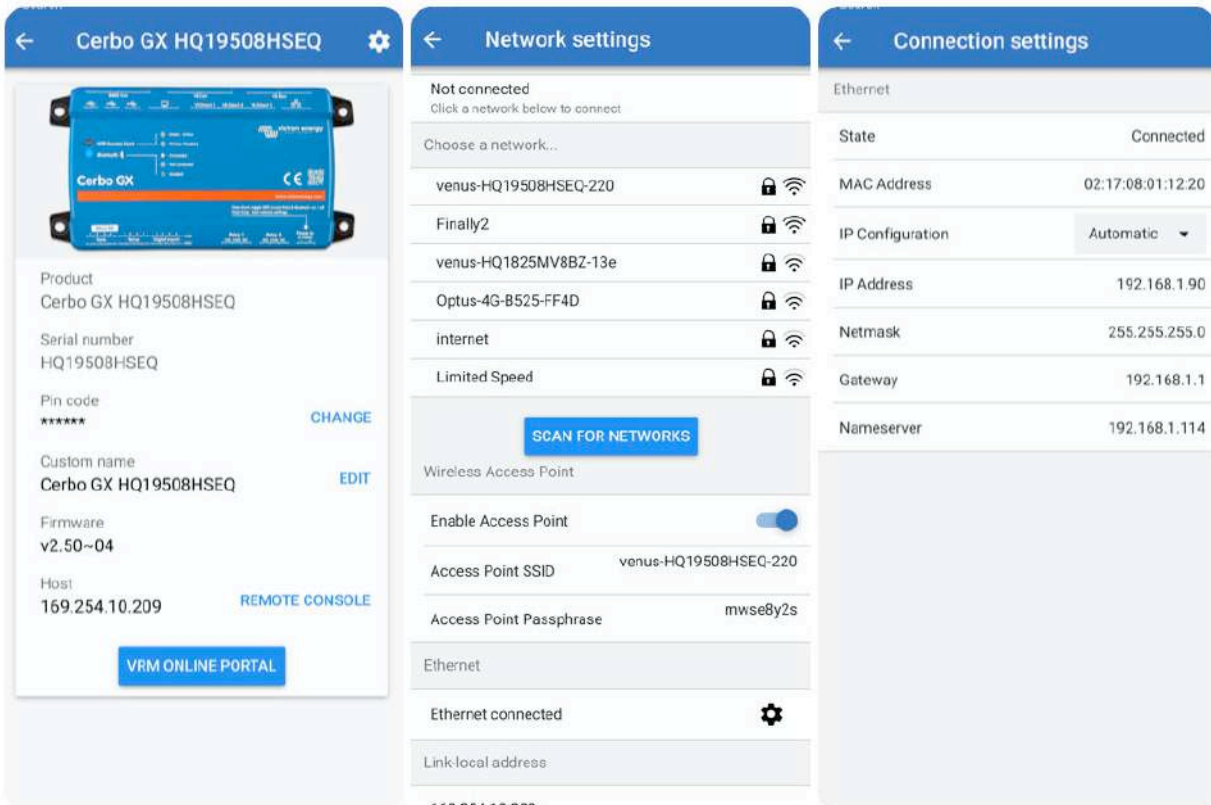

Note - Bluetooth functionality is limited to the features mentioned above. It is intended to be used to assist with initial connection and networking configuration. You cannot use Bluetooth to connect to other Victron products (e.g. SmartSolar charge controllers). For more information about how to connect other Victron products, please see [Connecting Victron products \[3\]](#)

## 4.2. Accessing via the built-in WiFi Access Point

This method requires the VictronConnect App to be installed on your smartphone, tablet or laptop.

Steps to Connect Automatically via the QR Code:

1. Locate the QR code sticker on the side of the Cerbo GX
2. Scan the QR code using your phone's camera function, or a QR code scanning app.
3. If supported by your phone, this will prompt you to connect you to the WiFi Access point.
4. Once connected, open VictronConnect
5. Select the GX device from the list
6. Open the Remote Console

Steps to Manually Connect:

1. Stand as close as possible from the Cerbo GX, and no further than a few meters away.
2. Go to the WiFi settings on your phone / tablet / laptop.
3. After searching, the Cerbo GX will show up in the list, as Venus-HQ1940DEF4-3b6. Where HQ... is the serial number as printed on the side of the box.
4. Connect to WiFi using the 'WiFi key' which you will find printed on the side of the box ...and also on a card in the plastic bag. Keep that in a safe place.
5. Open VictronConnect, it will start scanning the WiFi network automatically.
6. Once found, select the GX device from the list.
7. Open the Remote Console

Notes:

- If you cannot use VictronConnect, you can use a web browser and navigate to the IP address <http://172.24.24.1> or <http://venus.local>
- For added security it is possible to disable the WiFi Access Point. See Settings → Wi-Fi → Create access point. See below chapter explaining the Push button for how to restore access in case ever necessary.

### Instruction video

Step by step instruction video on how to connect to a GX device using the [VictronConnect App](#).

<https://www.youtube.com/embed/aKJMXxRikG0>

### Detailed instruction video

This second video was made before VictronConnect got the feature to find a device on a network. All the explanations in the video regarding IP Addressing can be ignored, and use VictronConnect as in above video instead.

[https://www.youtube.com/embed/ptYV\\_JEcaMU](https://www.youtube.com/embed/ptYV_JEcaMU)

## 4.3. Accessing Remote Console via the local LAN/WiFi Network

This section explains how to connect to Remote Console when the Cerbo GX is connected to the local computer network, with either an Ethernet cable, or having it configured to connect to a local WiFi network.

This method does not require an internet connection. Just a local computer network is sufficient.

Once connected, connect to the GX Device by running the [VictronConnect App](#) on a phone, tablet or laptop. Note that will need to be connected to the same computer network as the Cerbo GX.

This video shows how it is done

<https://www.youtube.com/embed/aKJMXxRikG0>

### 4.3.1. Alternative methods to find the IP Address for Remote Console

In case VictronConnect can't be used, here are a few other methods to find the Cerbo GX, ie. its IP Address.

#### Link Local Address - Venus.local

When the Remote Console on LAN setting is enabled. A direct connection (via network cable without a router or DHCP server) is possible. You can access the GX device by typing venus.local or http://venus.local into a web browser, or in VictronConnect when connected to the same network. Only Enable this function on trusted networks or direct connections. Make sure you have disabled the password check, or set a password first.

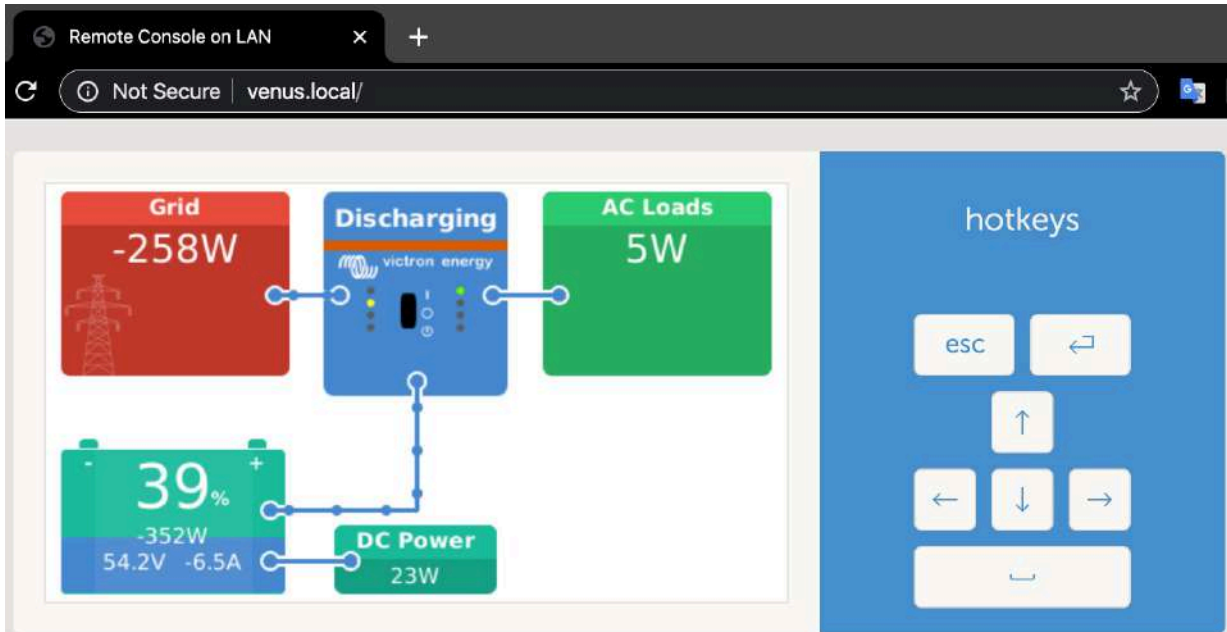

#### IP Address on VRM

On the VRM Portal, you'll find the IP address on the Device List page of the installation. Note that this does require the Cerbo GX to be connected to the internet.

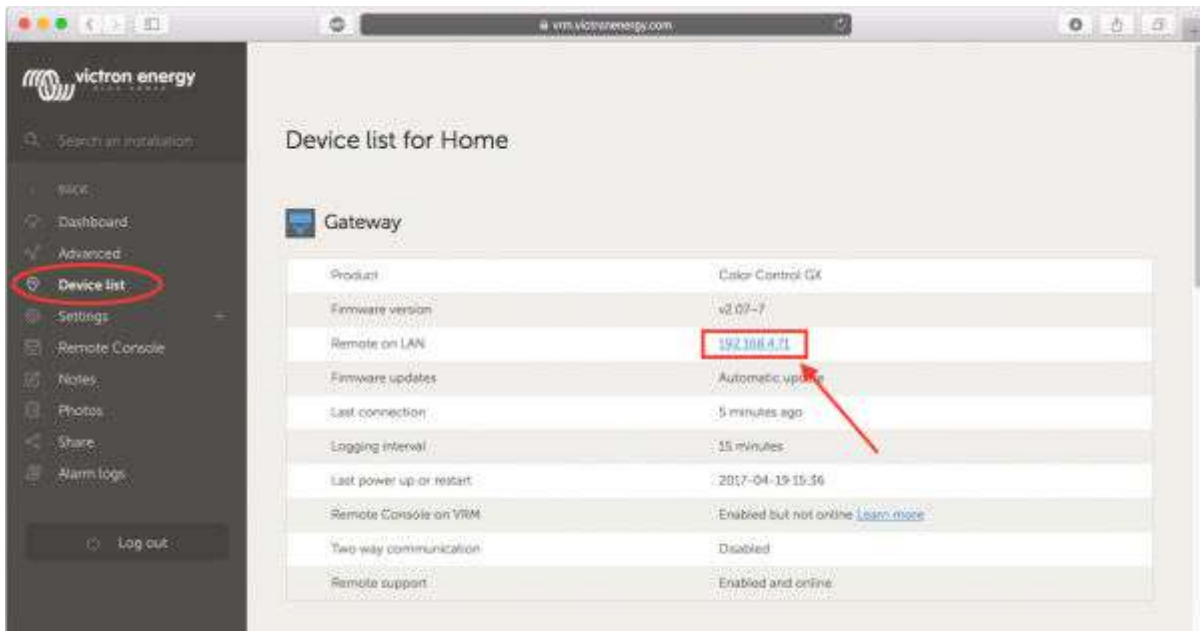

#### Network (on Microsoft Windows)

In a local network, for example at home, you can also find the Cerbo GX in the Windows 'Network' overview:

Double-clicking the icon will open up Remote Console on LAN.

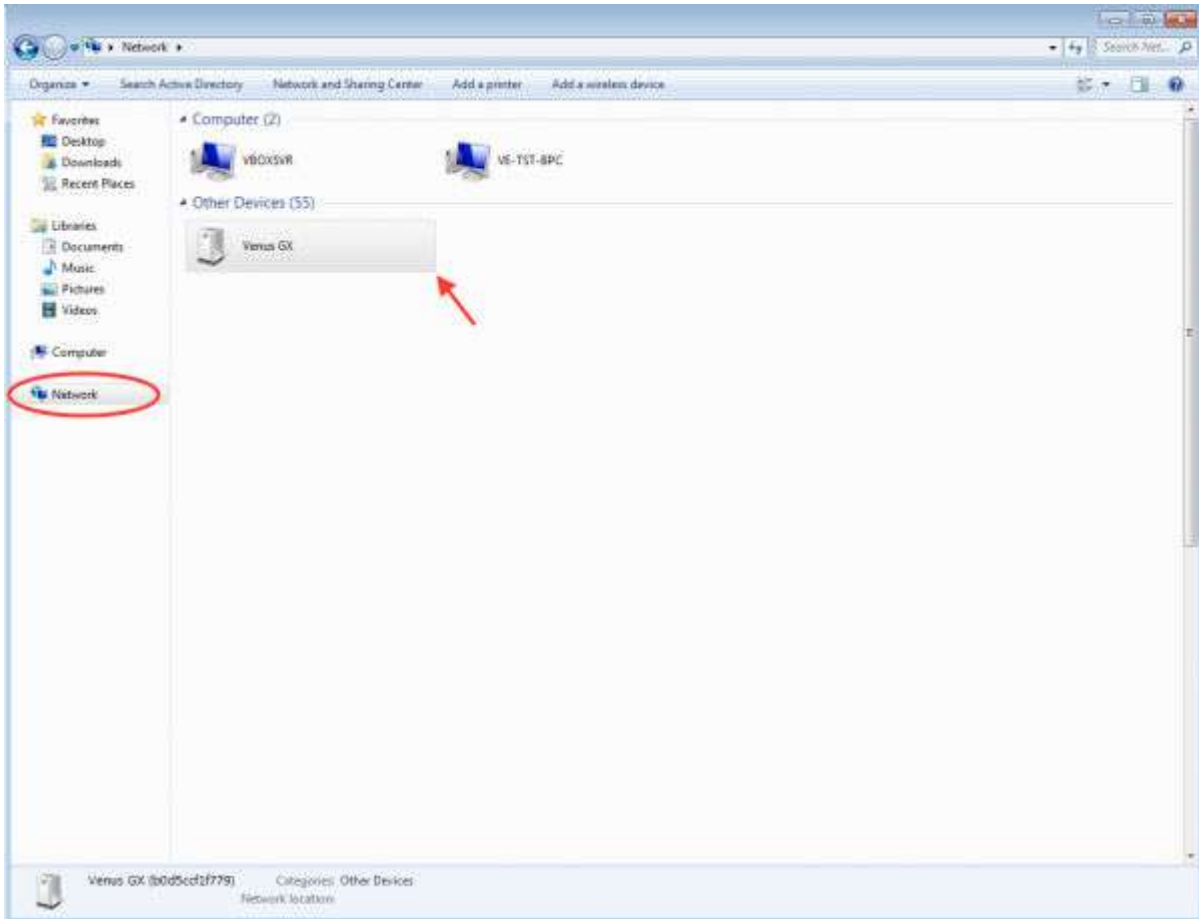

Open the 'Properties' window to see the IP address.

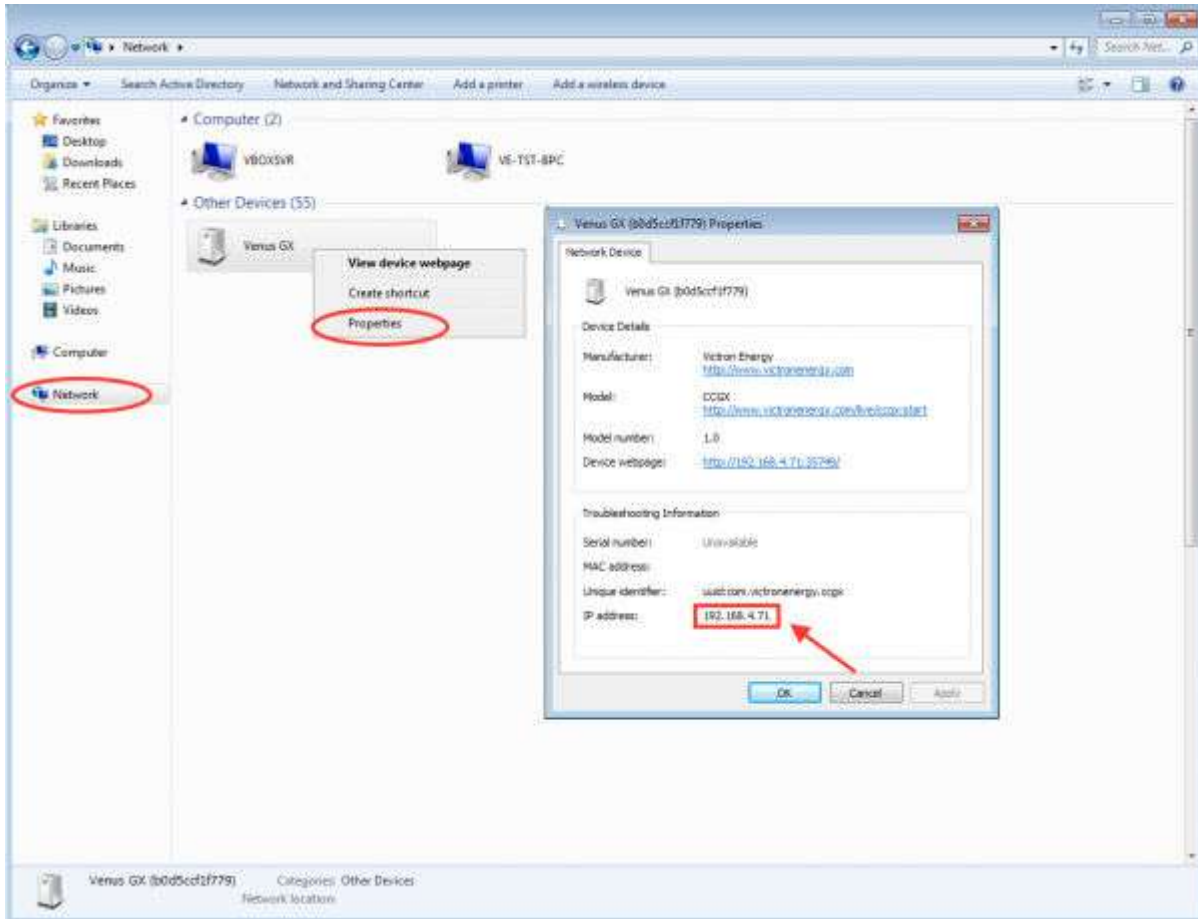

This uses Universal plug-and-play broadcast technology.

#### 4.4. Accessing via VRM

This method requires a working internet connection, both on your phone/tablet/laptop as well as for the Cerbo GX. For a new install, this means that it needs to be connected by Ethernet cable.

Step by step instructions:

First, connect the Cerbo GX to the internet by plugging it into a working Ethernet network which has a DHCP server, as most networks do, and which is connected to the internet. The Cerbo GX will immediately connect to VRM.

Now, go to the VRM Portal, <https://vrn.victronenergy.com/>, and follow the instructions to add the device. More information about this is available in the [VRM Manual](#).

Then once visible on VRM, click the 'Remote Console' link to open the window. Which will look like below screenshot.

More technical information in the related troubleshooting chapter: [Remote Console on VRM - Troubleshooting \[59\]](#).



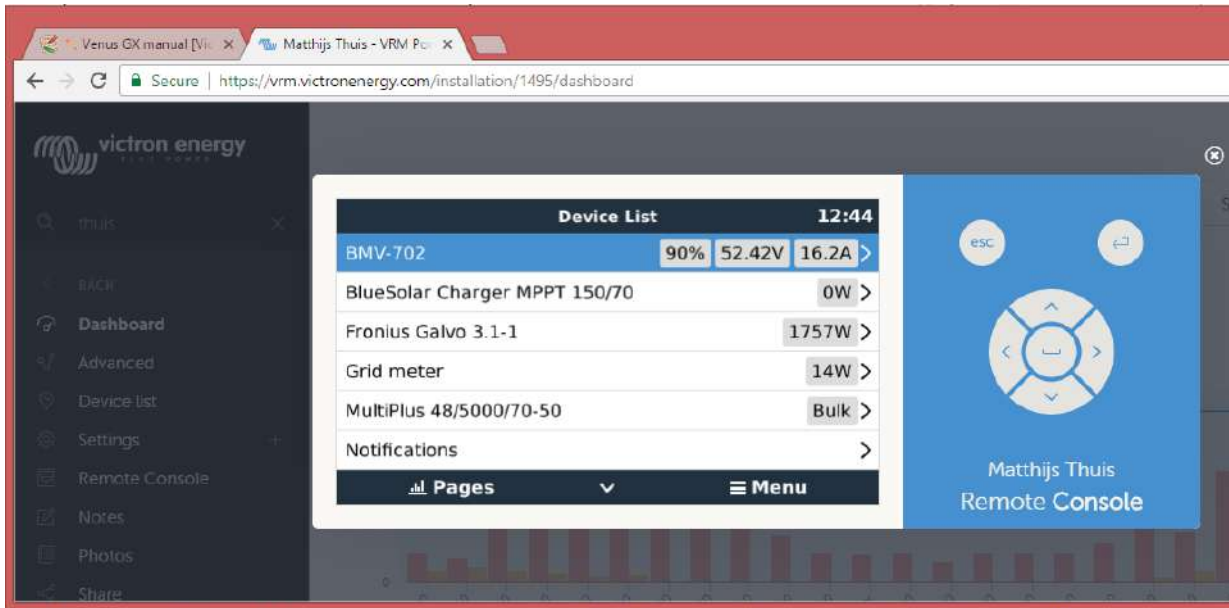

## 5. Configuration

### 5.1. Menu structure and configurable parameters

After completing the installation and setting up the internet connection (if required), go through the menu from top to bottom to configure the Cerbo GX:

Item	Default	Description
<b>General</b>		
Access level	User and installer	Set this to 'User' to prevent accidental and unwanted changes to the configuration. Installer has additional privileges and once changed from default requires a password. Password is available from your dealer.
Remote support	No	No / Yes - Enable this to allow Victron engineers to access your system in case there is a problem.
Reboot?		Reboots the GX device
Audible alarm	Yes	When there is an alarm on the Cerbo GX or a connected product, the Cerbo GX will beep - unless this setting is set to 'Off'.
Demo mode	Disabled	Demonstrates product and installation features to a client or at an exhibition. This simulation mode will allow better understanding without (yet) changing any settings. Note that this will add simulated devices to a VRM installation. Demos for ESS, Boat and Motorhome are available.
<b>Firmware</b>		
Firmware Version	x.xx	Displays the currently installed firmware version.
Build daate/time	xxx	Displays the build number.
 Note that for most system applications our advise is to keep automatic updates disabled; as is also the default factory setting. Instead, update the system at a convenient moment; when people are on location and ready to revert to a previous system and/or troubleshoot in case of issues.		
Online updates: Auto update	Check only	If this is Enabled, the GX device will check with the server to see if there is a new version available. It is possible to set to disable, or update automatically
Online updates: Update to	Latest release	Use the default setting unless you want to participate in test versions. End-user systems should certainly be set to 'Latest release'.
Install firmware from SD/USB		Use this menu to install a new version from a microSD card or USB stick. Insert the card or stick that holds the new firmware .swu file.
Stored backup firmware		With this feature you can go back to the previously installed firmware version.
<b>Date &amp; time</b>		
Date/Time UTC	Automatic from internet	-
Date/Time local	Automatic from internet	When connected to the internet, time will be automatically synchronised regardless of this setting. Toggle this setting to Manually input the time where no internet connection is present.
Change time zone	Select the correct local time zone.	
<b>Remote Console</b> - <a href="#">Read full feature description [21]</a>		
Disable password check	Password authentication not required for remote console access.	
Enable password check	Choose password to allow remote console access.	

Item	Default	Description
Enable on VRM	No	No / Yes - Enabling on VRM will allow connection to the Cerbo GX from anywhere via the VRM portal. <a href="#">Troubleshooting Remote Console on VRM</a>
Remote Console on VRM - Status	-	Displays the connection state of the VRM Remote Console Feature, eg Online, Offline, Disabled.
Enable on LAN	No	No / Yes - Enabling will allow direct connection to the Cerbo GX by typing its IP address or Venus.local into a web browser, or in VictronConnect when connected to the same network. Only Enable this function on trusted networks. Disable password check, or set password first
<b>System setup</b>		
System name	Automatic	Select the system name - presets or user defined
AC input 1	Generator	Select Generator, Grid or Shore power. Note additional configuration is required for complete setup of these options.
AC input 2	Grid	Same choices as above.
Monitor for grid failure	Disabled	Monitors for loss of AC-input, and triggers an alarm if detected. Alarm is cleared when the AC-input is reconnected.
Battery monitor	Automatic	Select the SoC source. This function is useful where there is more than one BMV. <a href="#">More details</a> .
Has DC system	No	Enable this for boats, vehicles and installations with DC loads and chargers - in addition to Multi and MPPT chargers. This won't be applicable to most off-grid installations; and any discrepancy between the DC current measured by the Multi, and by the BMV, will be attributed to a 'DC system'. This may be power-in from an alternator, or power-out from a pump, for example.  A positive value indicates consumption. A negative value indicates charging, for example by an alternator.  Note that the value shown will always be an approximation, and is affected by the variation in sample rate between elements of the system.
Battery Measurements	Not set	Use this menu to define which battery measurement to see on the VRM portal and the MFD HTML5 app.
System status	On/Off	The following parameters are diagnostic flags only. See section xyz for details:  Synchronize VE.Bus SoC with battery. Use solar charger current to improve VE.Bus SoC. Solar charger voltage control Solar charger current control BMS control
<b>DVCC - <a href="#">Read full feature description [48]</a></b>		
DVCC	No	Enabling DVCC changes a GX device from a passive monitor into an active controller. Default setting is No, unless a compatible BMS-Can managed battery is connected, then setting is set and locked to manufacturers specification.
Limit charge current	No	No / Yes - User-configurable system wide maximum charge current setting in Amps.
SVS - Shared voltage sense	No	No / Yes - The GX device automatically selects the best available voltage measurement and shares it with other connected devices.
STS - Shared temperature sense	No	No / Yes - The GX device will send the measured battery temperature to the inverter/charger system as well as all connected solar chargers.
Temperature sensor	Automatic	Select the temperature sensor to use for shared temperature sense measurement.

Item	Default	Description
SCS - Shared current sense	No	Forwards the battery current, as measured by a battery monitor connected to the GX device, to all connected solar chargers.
SCS status		Describes if SCS is enabled, or why it is disabled
<b>Display &amp; language</b>		
Adaptive brightness	Yes	Use the ambient light sensor to adjust screen brightness
Brightness	Configure the brightness between 0 and 100%	
Display off time	Set time-to-off between 10s / 30s - 1m / 10m /30m - or never	
Show mobile overview	No	Enable this to show the mobile overview page which is designed for Marine and Remote Vehicle applications. This overview gives direct access to the AC Current limit as well as the <i>On/Off/Charger-only</i> settings and pump control. Also shows up to four tank levels.
Language	English	Choose between English, Dutch, Chinese, German, Spanish, French, Italian, Swedish, Turkish and Arabic.
Units	°C	The available options are Celsius and Fahrenheit. Please note that this setting does not affect the temperature unit in the VRM portal.
<b>VRM online portal</b> - <a href="#">Read full feature description [55]</a>		
Logging enabled	Enabled	-
VRM Portal ID	-	Use this value when registering the GX device onto the VRM Portal
Log interval	15 minutes	Set to anything between 1 minute and 1 day. Choose longer times on systems with an unreliable connection. Note that this setting does not affect reporting problems and state changes (bulk → absorption) to the VRM Portal. These events initiate an immediate transmission of all parameters.
Use secure connection (HTTPS)	Yes	This encrypts the communication between the GX device and the VRM server.
Last contact	-	Time since the VRM server was last contacted.
Connection error	-	Displayed if there is an error in VRM communications. <a href="#">See here for more details on troubleshooting VRM errors. [56]</a>
VRM two-way communication	No	Enable <a href="#">remote configuration</a> and <a href="#">firmware updates</a> .
Reboot device when no contact	No	The GX device will reset itself to attempt to correct a potential networking issue if the internet connection is lost for the set delay period.
No contact reset delay (hh:mm)	01:00	How long the unit must be offline before restarting itself
Storage location	Internal storage	Displays if an external storage device (eg USB drive or microSD card) is mounted, or the internal storage is in use.
Free disk space	-	
microSD/USB	-	Select to Safely Eject an external microSD or USB storage (if one is connected) before physically removing it. Failure to do so can cause data loss.
Stored records	-	How many records are stored locally when no internet connection is available. The GX device will store as many records as it can locally, then upload them when internet is available again.
Oldest record age	-	If internet/VRM is not available, then this will display the oldest record stored on the GX device.
<b>ESS</b> - An Energy Storage System (ESS) is a specific type of power system that integrates a power grid connection with a Victron Inverter/Charger, GX device and battery system. <a href="#">Read full feature description.</a>		
Mode	Optimized (with BatteryLife)	Optimized (with BatteryLife) and Optimized (without BatteryLife), Keep batteries charged, External control

Item	Default	Description
Grid Meter		Leave default when there is no External Victron grid meter is installed.
Inverter AC output in use	Yes	Setting this to 'No' hides the AC-out graphic in the overview pane.
Multiphase regulation	-	Use the Phase compensation setting in systems with a three-phase connection to the utility grid.
Minimum SOC (unless grid fails)	10%	Configurable minimum SOC limit. ESS will supply loads from the grid once the SOC has fallen to the configured setting - except when the utility grid has failed and the system is in Inverter mode.
Active SOC limit	10%	Use this setting to see the current BatteryLife SOC level.
BatteryLife state	Self-Consumption	Self-consumption, Discharge disabled, Slow charge, Sustain, Recharge
Limit charge power	No	This setting limits the flow of power from AC to DC for battery charging from AC-in.
Limit inverter power	No	Limit the power drawn by the Multi: ie. limit the power being inverted from DC to AC.
Grid setpoint	50W	This sets the point at which power is taken from the grid when the installation is in self-consumption mode.
Scheduled charging	No	Allows you to set up to five scheduled periods, during which the system will take power from the grid to charge the battery.
<b>Energy meters</b> - <a href="#">Read full feature description</a>		
Role	Grid meter	Grid meter, PV inverter, Generator, AC load
Phase type	Single phase	
Modbus unit ID	30	
<b>PV inverters</b> - <a href="#">Read full feature description</a>		
Inverters:		Shows connected AC PV inverters
Inv: Position	AC Input 1	AC input 1, AC input 2, AC Output
Inv: Phase	L1	
Inv: Show	Yes	
Find PV inverters		Scan for available PV inverters
Detected IP addresses		Shows the IP address of PV inverters that have been discovered
Add IP address manually		If an inverter has a manually assigned IP address, you can add it directly here.
Automatic scanning	Yes	This setting will continue to look for PV inverters, this can be useful if using a DHCP assigned IP address that might change.
<b>Wireless AC sensors</b>		
Select the position for each AC sensor (PV Inverter on AC-input 1, 2 or on AC-output). <a href="#">More information about the Wireless AC sensors.</a>		
<b>Ethernet</b> - <a href="#">read full feature description [18]</a>		
State	Connected	
MAC address	-	
IP configuration	Automatic	
IP address	-	
Netmask	-	
Gateway	-	
DNS server	-	
Link-local IP address	-	
Select the configuration type (DHCP vs. manual configuration) and IP settings.		
<b>Wi-Fi</b> - <a href="#">Read full feature description [18]</a>		

Item	Default	Description
Create access point		
Wi-Fi networks		
Name		
Connect to network		
Forget network		
Signal strength		
MAC address		
IP configuration		
IP address		
Netmask		
Gateway		
DNS server		
Manage wireless networks and IP settings.		
<b>GSM modem</b> - <a href="#">Read full feature description</a>		
<b>Bluetooth</b>		
Enabled	Yes	
Pincode	000000	
<b>GPS</b> - <a href="#">Read full feature description [7]</a>		
GPS information		Status, Latitude, Longitude, Speed, Course, Altitude, Number of satellites
Format	Select the format in which to show the Latitude and Longitude.	
Speed unit	km/h	Choose between km/h, meters per second, miles per hour, or knots.
Device		Connected, Connection, Product, Product ID, Firmware version, Device instance
<b>Generator start/stop</b>		
Configure generator autostart settings and conditions. <a href="#">Read full feature description</a>		
State		Displays if the generator is running or not
Error		Displays if there is error (eg generator is supposed to be running but no AC input is detected)
Total run time		Total time the generator has been running since reset.
Time to next test run		If a periodic run is programmed, this counter will display in days, and hours how long before that will occur.
Auto start functionality		Enable or Disable the Autostart functions, this can be further configured in the Generator -> Settings -> Conditions menu
Manual start		Start generator, Run for hh:mm
Daily run time		Submenu shows the history of time generator has been running (minutes) each day for the previous 30 days.
<b>Generator start/stop -&gt; Settings</b>		
<b>Generator start/stop -&gt; Settings -&gt; Conditions</b>		
On loss of communication	Stop generator	Stop, Start, Keep generator running
Do not run generator when AC1 is in use	No	This option is ideal for back-up systems where a Quattro has mains/grid electricity connected to its AC-in 1 terminal, and a Genset connected to its AC-in 2 terminal. With this option enabled, the Genset will only start after a mains failure.

Item	Default	Description
Battery SOC	No	Use Battery SOC value to start/stop - No / Yes Start when SOC is lower than - % Start value during quiet hours - % (to override programmed quiet hours when absolutely necessary) Stop when Battery SOC is higher than - % Stop value during quiet hours - % (allows for less runtime during quiet hours, once system is recovered)
Battery current	No	Use value to start/stop - No / Yes
Battery voltage		Start when value is higher than - Amps / Voltage / Watts
AC output		Start value during quiet hours - Amps / Voltage / Watts (to override programmed quiet hours when absolutely necessary) Start after condition is reached for - seconds (to allow for momentary spikes to pass without triggering start) Stop when value is lower than - Amps / Voltage / Watts Stop value during quiet hours - Amps / Voltage / Watts (allows for less runtime during quiet hours, once system is recovered) Stop after the condition is reached for - seconds (to allow for momentary dips without stopping the running generator)
Inverter high temperature	No	Start on value warning - No / Yes
Inverter overload		Start when warning is active for - seconds (to allow for momentary spikes to pass without triggering start) When warning is cleared stop after - seconds (to allow for momentary dips without stopping the running generator)
<b>Generator start/stop -&gt; Settings -&gt; Conditions -&gt; Periodic run</b>		
Periodic run	No	Enable - No / Yes Run interval Skip run if has been running for Run interval start date Start time Run duration (hh:mm) Run until battery is fully charged
<b>Generator start/stop -&gt; Settings</b>		
Minimum run time	0	The minimum number of minutes the generator will run for any time that it is started, even after stop conditions.
Detect generator at AC input	No	No / Yes - An alarm will be triggered when no power from the generator is detected at the inverter AC input. Make sure that the correct AC input is set to generator on the system setup page.
Quiet hours	0	Quiet hours will prevent normal generator run conditions from starting the generator. It is possible for some settings to specify override values to the quiet hours ( an extremely low battery voltage trigger to prevent a system shutdown for example)
Reset daily run time counters		An option to reset generator run time counters, for example if these are used for service, or if the generator is replaced or majorly repaired.
Generator total run time (hours)		The total time the generator has been running since the counter was reset.
<b>Tank pump</b>		
Configure automatic starting and stopping of pump based on tank level(sender) information. <a href="#">Pump auto start/stop with Color Control GX</a>		
Pump state		Displays if the pump is running or not
Mode	Auto	Options are Auto, On and Off. This is the manual override to the start and stop level triggers when a tank sensor is connected.

Item	Default	Description
Tank Sensor	Automatic	Select the tank sensor that is used for the tank pump trigger. 'No tank sensor' will be displayed if no tank sensor is connected or detected,
Start level	50%	The trigger point of the tank level to start the tank pump (close the relay).
Stop level	80%	The trigger point of the tank level to stop the tank pump (open the relay).
<b>Relay</b>		
Function	Alarm relay	Select the relay function. Possible functions are 'Alarm relay', 'Generator start/stop', 'Tank pump', 'Temperature', and 'None' (disabled).
Polarity	Normally open	Select the polarity of the relay on the back of the Cerbo GX. 'Normally open' or 'Normally closed'. (Note that setting it to normally closed increases the Cerbo GX power draw.)
<b>Services</b>		
ModbusTCP	Off	This setting enables the ModbusTCP service. More information about <a href="#">ModbusTCP in this document</a> and in the communications white paper <a href="https://www.victronenergy.com/upload/documents/Whitepaper-Data-communication-with-Victron-Energy-products_EN.pdf">https://www.victronenergy.com/upload/documents/Whitepaper-Data-communication-with-Victron-Energy-products_EN.pdf</a>
MQTT on LAN (SSL)	On	Enables MQTT on LAN - More information on MQTT is available on <a href="#">Victron Community</a> .
MQTT on LAN (Plaintext)	Off	This setting is required to be enabled when connecting an Marine MFD
VE.Can port	VE.Can	CAN-bus profile (Disabled, VE.Can & Lynx Ion BMS 250 kbit/s, VE.Can & Can-bus BMS 250 kbit/s, CAN-bus BMS 500 kbit/s, Oceanvolt 250 kbit/s), Send data to VE.Can, Unique device number for VE.Can, Check unique numbers
BMS-Can port	-	CAN-bus BMS (500 kbit/s)
CAN-bus		CAN-bus profile, Send data to VE.Can, Unique device number for VE.Can, Check unique numbers
<b>I/O</b>		
Analog inputs	On	Available tank level sensors On/Off, Available Temperature sensors On/Off
Digital inputs	Off	Available Digital inputs Off, Door alarm, Bilge pump, Bilge alarm, Burglar alarm, Smoke alarm, Fire alarm, CO2 alarm, Generator

When using a VE.Bus system, it is possible to configure the severity of problems on the VE.Bus system that should cause a notification to show up on the Cerbo GX (and make it beep):

- Disabled: The Cerbo GX will never beep or show a notification
- Alarm only: The Cerbo GX will only beep and show a notification when the VE.Bus system switched off in an alarm condition.
- Enabled (default): The Cerbo GX will beep and show a notification

When all done, don't forget to change the access level to user when required.



## 5.2. Battery state of charge (SoC)

### 5.2.1. Which device should I use for SoC calculation?

There are three products types that calculate state of charge (SoC). The Cerbo GX itself does not calculate SoC, it only retrieves it from the connected devices.

The three products that calculate SoC are:

1. Battery Monitors, such as the BMVs, SmartShunt, Lynx Shunt, Lynx Smart BMS or the Lynx Ion BMS
2. Multi and Quattro inverter/chargers
3. Batteries with built-in battery monitor and a (mostly BMS-Can) connection to the Cerbo GX.

#### When to use what?

If you have a battery with built-in battery monitor, such as a BYD or Freedomwon battery; its easy. Use that.

If not, then the options depend on the type of system:

1. If the MultiPlus or Quattro inverter/charger is the only source of charge to the batteries and the only draw then it can function as a basic battery monitor because it counts what went in and counts what comes out. No need for a dedicated battery monitor such as the BMV.
2. If the systems consists of an inverter/charger, MPPTs and a [GX device](#), then there is still no need to add a dedicated battery monitor.
3. For any other system types, such as a boat or RV with DC lights and other DC loads, a dedicated battery monitor will be required.

### 5.2.2. The different solutions explained in detail

#### (A) Battery and Multi or Quattro (a typical backup system)

No battery monitor is required: the Multi or Quattro is the only product connected to the battery and has full control over all charge and discharge currents. Therefore it can calculate the correct SoC itself.

Configuration:

1. Enable and configure the battery monitor in VEConfigure.
2. In the Cerbo GX, in Settings → System setup, verify the selected battery monitor. It should be set to the Multi or Quattro.

#### (B) Battery with Multi or Quattro and MPPT Solar Chargers -ALSO- An EasySolar with GX Device built-in

No battery monitor is required as long as all MPPT solar chargers are Victron products and are connected to the Cerbo GX. The Cerbo GX will continuously read the actual charge current from all solar chargers and send the total to the Multi (or Quattro), which then uses that information in its SoC calculations.

Configuration:

1. Enable and configure the battery monitor in VEConfigure.
2. On the Cerbo GX, in Settings → System setup, verify the selected battery monitor. It should be the Multi or Quattro.
3. In the System status menu, verify that the option 'Use solar charger current to improve VE.Bus SOC' is set to On. Note that this is not a setting - it just an indicator of an automatic process.

Note that this feature requires recent firmware versions in both the Multis or Quattros (402 minimum), and the Cerbo GX (v2.06 minimum).

#### (C) Batteries with a built-in battery monitor

In cases where the system includes a battery which has a built-in battery monitor and SoC calculation - such as many of the batteries listed [here](#) - a dedicated battery monitor is not required.

Configuration:

1. Connect the battery communications cable to the Cerbo GX according to the instructions.

2. In the Cerbo GX, in Settings → System setup, verify that the selected battery monitor is the battery.

Note that the battery monitor setting in VEConfigure is irrelevant. For systems like this, changing this setting will have no effect on the charge or any other parameters in this type of system.

#### (D) Other system types

When there are more chargers or loads than just the Multi or MPPT solar chargers connected to the battery, a dedicated battery monitor is required. Examples are:

- House loads in Marine or Vehicle system.
- PWM solar chargers
- AC chargers, such as Skylla-is, Phoenix Smart IP43 chargers, non Victron chargers, etc.
- Alternators
- DC-DC chargers
- Wind turbines
- Hydro turbines

In case a battery with built-in monitor is used, such as explained in (C), then that is the dedicated battery monitor. Refer to section (C).

Otherwise install a BMV or Lynx Shunt VE.Can.

Configuration:

1. Configure the battery monitor as per its documentation.
2. In the Cerbo GX, in Settings → System setup, verify the selected battery monitor.
3. It should be the BMV, SmartShunt, Lynx Smart BMS or Lynx Shunt battery monitor.
4. Finished.

Note that the battery monitor setting in VEConfigure is irrelevant. For systems like this, changing this setting will have no effect on the charge - or any other parameters - in this type of system.

### 5.2.3. Notes on SoC

- Note that this is all about showing an accurate state of charge to the user, rather than being required for an efficient system. The SoC percentage is not used for battery charging. It is, however, required when a generator needs to be started and stopped automatically based on battery SoC.

More information:

[VRM Portal FAQ - difference between BMV SOC and VE.Bus SOC](#)

See [Configurable Parameters Section](#) on Battery monitor selection and Has DC system.

### 5.2.4. Selecting SoC source

(Settings → System Setup → Battery monitor)

In the image below you can see a range of selectable choices for the SoC values which are shown in the main Overview screen. Choose the source you want to see on the main Overview screen of your Cerbo GX.



In the image above we have chosen the Automatic setting. When automatic is selected, the System setup screen will be as shown in the image below.



The 'Automatic' function uses the following logic:

1. When available, it will use a dedicated battery monitor, such as the BMV or a Lynx Shunt, or a battery with built-in battery monitor.
2. When there is more than one of those connected, it will use a random one - although you can select one manually.
3. When there is no dedicated battery monitor, it will use the VE.Bus SoC.

When should I use the 'No battery monitor' option?:

Use that in systems where:

1. there is a Multi or Quattro installed
2. no BMV or other battery monitor is installed
3. the system has other DC loads or other chargers connected to the same battery, which are not connected to the Cerbo GX.

A short explanation: The VE.Bus SOC determined by the Multi or Quattro is incorrect in the above situation as it does not take into account the discharge and charge currents by those other DC loads and also unmonitored chargers.

### 5.2.5. Details on VE.Bus SOC

- While the Inverter/Charger is in bulk, the SoC will not rise above the value as set in VEConfigure for the 'State of charge when Bulk finished' parameter on the General tab; default 85%. In a system with solar chargers, make sure that the Absorption voltage as configured in the MPPT is slightly above the same setting in the inverter/charger. The latter needs to recognize that the battery voltage has reached the absorption level. If it doesn't, the SoC will be stuck at the earlier mentioned End-of-bulk percentage, default 85%.

### 5.2.6. The System Status menu

The System Status menu contains diagnostic flags that can be useful in diagnosing problems with the system. Note that nothing can be configured here. The on/off flag depends on how a system is set up and what devices it contains.



Their meaning in detail are:

**Synchronise VE.Bus SoC with battery:**

- If On, it indicates that the activated battery monitor in the Multi/Quattro is synchronising its SoC with that of a better source (a BMV or BMS in the system). The system does that automatically.

**Use solar charger current to improve VE.Bus SoC:**

- In a VE.Bus system with no other battery monitor (no BMS, no SmartShunt, no managed battery) but with solar chargers, the solar charge current is taken into account and helps improve the SoC calculation of the internal Multi/Quattro battery monitor. The system does this automatically and indicates that it is active by displaying On.

**Solar charger voltage control:**

- If on, this indicates that the solar chargers are not following their own internal charge algorithm. They're getting a voltage setpoint from somewhere else. Either a) a managed battery or b) in an ESS system, they get it from the Multi/Quattro.

**Solar charger current control:**

- This indicates that the solar chargers are current limited by the system. In most cases the limiting device is a managed battery or a user-defined Maximum charge current in the DVCC menu.

**BMS control:**

- It indicates that the BMS is controlling the charge voltage setpoint (and not using the value set for absorption and float in the Multi/Quattro or solar charger).

### 5.3. Customize the logo on the Boat & Motorhome page

It is possible to use a custom logo onto the Boat & Motorhome page.

Type the following address into the web browser of a device connected to the same network. Using this address as a template: <http://venus.local/logo.php> or [http://\[ip-here\]/logo.php](http://[ip-here]/logo.php) (inserting your device's IP address between the square brackets). The IP address can be found by going to Settings -> Ethernet or Wifi. Once the page is loaded, Choose an image file from your device. Re-boot the GX device.

## 5.4. Temperature relay

It is possible to configure the built in Relay 1, and Relay 2, to activate and deactivate based on temperature.

See [Connecting Temperature Sensors section \[9\]](#) for compatibility and connection instructions. Confirm the temperature sensors are correctly connected and reporting temperature in the menu.

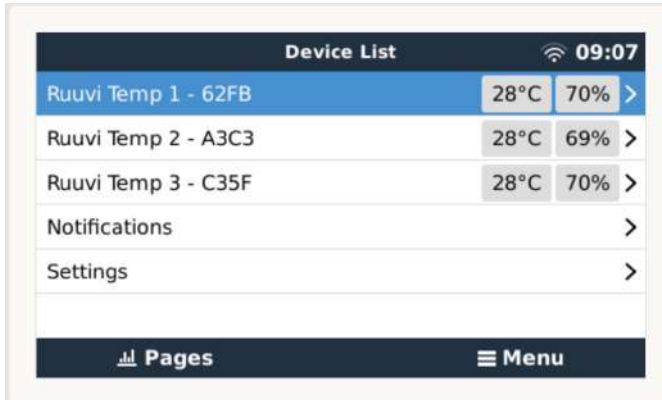

The temperature relay is controlled from Settings Menu -> Relay -> Function (Relay 1/2) -> Temperature

Once enabled, the Temperature control rules menu will appear in the Relay menu, and inside the temperature sensors that have been detected.



Each temperature sensor can be used to control the relay.

Select the temperature sensor you wish to use to control the relay. The temperature sensors that aren't used will display "No actions".

It is possible to enable or disable the temperature relay control for each temperature sensor within this menu.

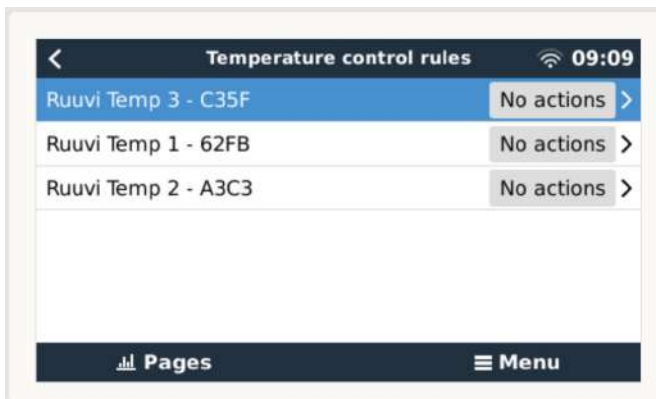

In GX products where two relays are available (Cerbo GX & Cerbo-S GX) it is possible to have a single temperature sensor control both relays. It is also possible to have a single relay controlled by multiple different temperature sensors.

For example, a Cerbo GX with 2 lithium battery heat pads, and only using both simultaneously when necessary.

1. In the Relay -> Temperature control rules -> Temperature sensor menu
2. Enable Relay activation on temperature
3. Assign the relay control to Relay 1
4. Set the Activation value to 5 degrees
5. Set the Deactivation value to 10 degrees

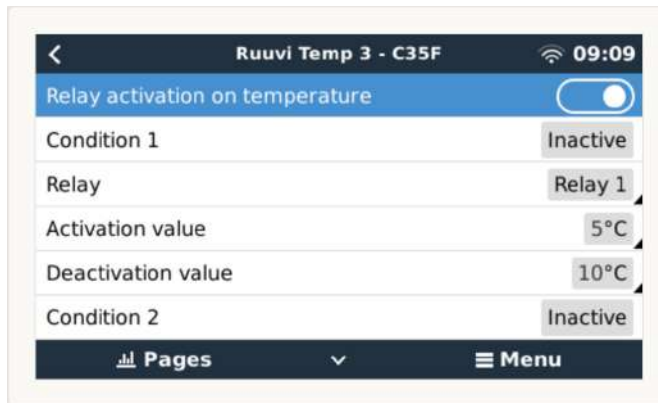

If that is insufficient to maintain the battery temperature above 5 degrees, you may wish to connect a 2nd heat pad contactor to Relay 2 as well.

1. Move down menu to Condition 2
2. Assign the relay control to Relay 2
3. Set the Activation value to 4 degrees
4. Set the Deactivation value to 6 degrees

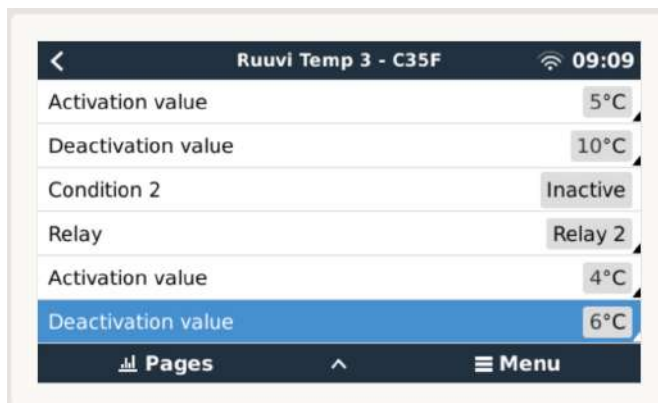

This will mean that Relay 1 will be active if the battery temperature falls to 5 degrees. If the temperature continues to fall below 5 degrees to 4 degrees, then the second heat pad will be engaged via Relay 2.

If that is sufficient to raise the temperature back to 6 degrees, Relay 2 will deactivate, and then Relay 1 will remain active until battery temperature returns to 10 degrees.

Note that the physical wiring contacts are available for both Relay 1 and Relay 2 in Normally Open, and Normally Closed configurations.



Note specifications for the power limits of the relays. It may be necessary to connect appliances via an additional contactor if power requirements exceed the relay power limit specification.

## 6. Firmware updates

### 6.1. Changelog

The changelog is available in [Victron Professional](#) in the Firmware → Venus OS directory. To access Victron Professional, you need to [sign up](#) (free).

### 6.2. Via internet or with microSD-card/USB-stick

There are two ways to update the firmware:

1. Update it via the internet, either manually or let it check for new updates every day.
2. Update it from a microSD-card or USB-stick.

#### 6.2.1. Direct download from the internet

On GX devices without a display (ie. a Venus GX or Cerbo GX without GX Touch), use [Remote Console](#) to get to below menus.

1. To update from the internet, navigate to: **Settings** → **Firmware** → **Online updates**.
2. Press 'Check for updates'.
3. If there is a newer firmware version, it will be shown under 'Update available'. Press to update to the new firmware version.
4. After the GX device has been updated to the new firmware version, make sure to check the settings of your installation.



Note that for most system applications our advise is to keep automatic updates disabled; as is also the default factory setting.

Instead, update the system at a convenient moment; when people are on location and ready to revert to a previous system and/or troubleshoot in case of issues.

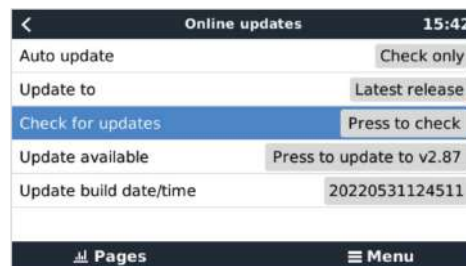

#### 6.2.2. microSD-card or USB-stick

Updating with a microSD-card or USB-stick is called 'Offline updating'. Use it when updating a device that is not connected to the internet.

##### Step 1. Download

Get the latest swu file:

- [Cerbo GX - venus-swu-einstein.swu](#)

Note that the same files and the changelog is available on [Victron Professional](#). There is also a Dropbox connection to connect your Dropbox to our shared folder, so you always have the latest firmware files available on your laptop.

##### Step 2. Install on a microSD-card or USB-stick

Store the file in the root folder of a USB-stick or microSD-card.

##### Step 3. Insert the device

Note that you will see a warning "Attached storage contains a firmware image, not using for data logging.". That warning can safely be ignored.

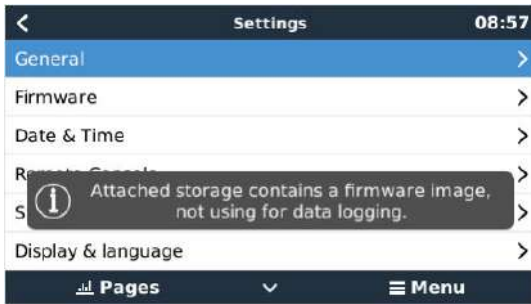

#### Step 4. Initiate the update

Navigate to **Settings** → **Firmware** → **Install firmware from SD/USB**.

Press 'Check for firmware on SD/USB'.

If the firmware in the microSD-card or USB-stick is newer than the running one, 'Firmware found' item will appear, press it to start the update process.

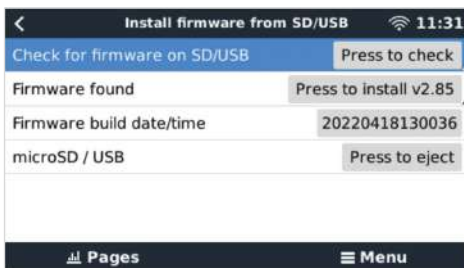

## 6.3. Revert to a previous firmware version

There are two ways to revert to a previous firmware version:

1. Using the Stored firmware backup feature or
2. by downloading a specific firmware file, saving it onto a microSD-card or USB-stick and install from SD/USB.

### 6.3.1. Stored firmware backup feature

This option allows you to switch between the current and the previous firmware version. No internet or SD-card needed.

1. Go to **Settings** → **Firmware** → **Stored backup firmware**.
2. The following screen shows the firmware version currently running and the firmware version that can be booted.
3. Click on 'Press to boot' to boot into the stored firmware version.
4. The stored firmware version is now booted and the previous firmware version will be saved instead.



### 6.3.2. Install a specific firmware version from SD/USB

There may be reasons why it is necessary to manually download and install a specific firmware version (e.g. an older firmware version that is not stored under "Stored backup firmware" on the GX device). This chapter explains how to do that.

1. Old Venus OS firmware versions are available for download here: <https://updates.victronenergy.com/feeds/venus/release/images/>



2. For Cerbo GX use the einstein folder.
3. Download the .swu file of the version required.
4. Store the .swu file in the root folder of a USB-stick or MicroSD-card.
5. Insert the USB-stick or MicroSD-card into your GX device.
6. Note that you will see a warning "Attached storage contains a firmware image, not using for data logging.". That warning can safely be ignored.
7. Navigate to **Settings** → **Firmware** → **Install firmware from SD/USB**.
8. It should show the specific firmware version under 'Firmware found'. Click on it to install.



Note that while backporting is no problem in general, it may be that some settings are reset to their default values. Be sure to check this.

## 6.4. Venus OS Large image

In addition to the normal Venus OS firmware, it is also possible to install Venus OS Large, an extended build of Venus OS that adds Node-RED and Signal K Server.

Among other features, Node-RED offers a fully customisable dashboard that can be viewed in a web browser - both locally and remotely, via the VRM Servers.

Signal K Server is designed for yachts and multiplexes data from NMEA 0183, NMEA 2000, Signal K and other sensor inputs. Data from all devices connected to the GX device is automatically available in SignalK for further processing.

Please note that there is and will be no official support on the extended functionalities included in the Venus OS Large image.

After installing the normal firmware version, there is an option 'Image type' in the 'Online updates' menu, which also allows to select 'Large' for the Venus OS Large image type and updating firmware like described in this chapter.

A detailed description of all functions and how to install can be found in our document [Venus OS Large image: Signal K and Node-RED](#).

## 7. VE.Bus Inverter/charger monitoring

### 7.1. Input current-limiter setting

#### 'Overruled by remote' setting in VEConfigure

This chapter explains the implications of enabling or disabling user control of the input current-limiter setting, as seen here in the menu:



The limit as set by the user in the Cerbo GX will be applied to all inputs where 'Overruled by remote', configured with VictronConnect or VEConfigure, is enabled:

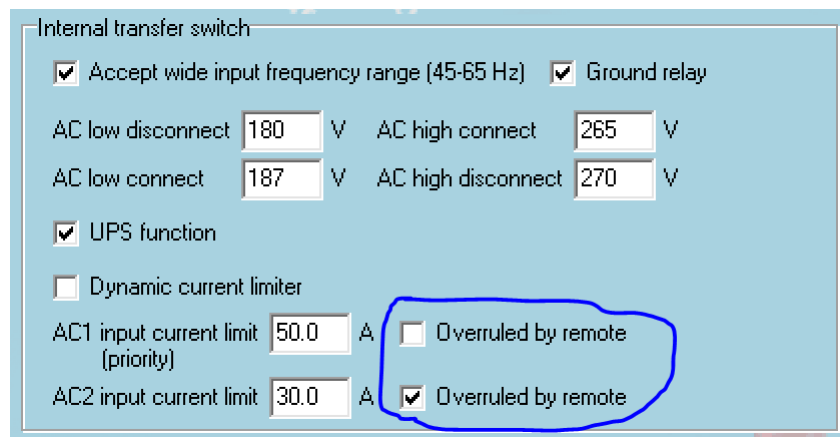

Using the example of a boat with two AC inputs and a Quattro where:

1. A Genset capable of delivering 50A is connected to input 1;
2. Shore power is connected to input 2. (Available power depends on the rating of the harbour power-supply.)

Configure the system exactly as in above VEConfigure screenshot. Input 1 has priority over input 2, therefore the system will automatically connect to the genset whenever it is running. The fixed input current limit of 50A will be applied. And when the genset is not available, and mains is available on input 2, the Quattro will use the input current limit as configured in the Cerbo GX.

Two more examples: (In both cases if you disable 'Overrule by remote', setting a current limit in the Cerbo GX will have no effect. And if you enable 'Overrule by remote' for both inputs, the current limit set in the Cerbo GX will be applied to both inputs.)

#### Minimum input current limit values

When PowerAssist is enabled in VEConfigure, there is a minimum input current limit. The actual limit differs for each model.

After setting the input current to a value below the limit, it will automatically be increased again to the limit.

Note that it is still possible to set the input current limit to 0. When set to 0, the system will be in passthrough (charger disabled).

#### Parallel and three phase systems

The configured AC input current limit is the total limit per phase.

## 7.2. Phase rotation warning

The AC supply, either Generator or Grid, to a three phase inverter/charger system needs to be in the correct rotation, also known as sequence. If not, then the Inverter/chargers will not accept the AC supply and remain in Inverter mode.

The Phase rotation warning will be raised in such case. To resolve the issue, change the wiring on the AC input: swap either one of the phases, effectively changing the rotation from L3 → L2 → L1 to L1 → L2 → L3. Or reprogram the Multis and modify the phase assigned to match the wiring.

On the GX device itself, the warning will be popup as a notification on the GUI:

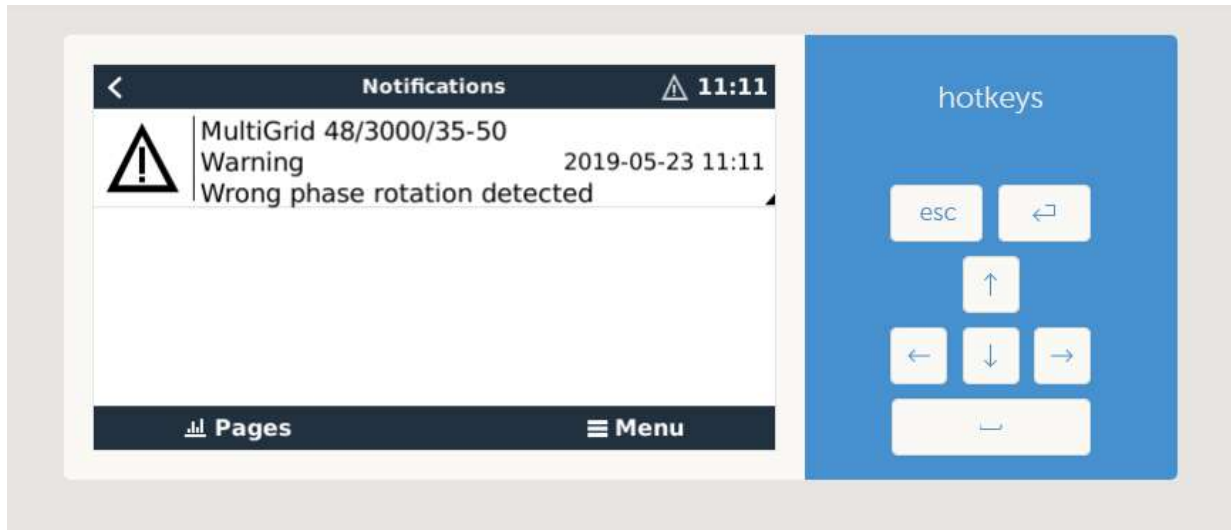

Also, it is visible in the menus:

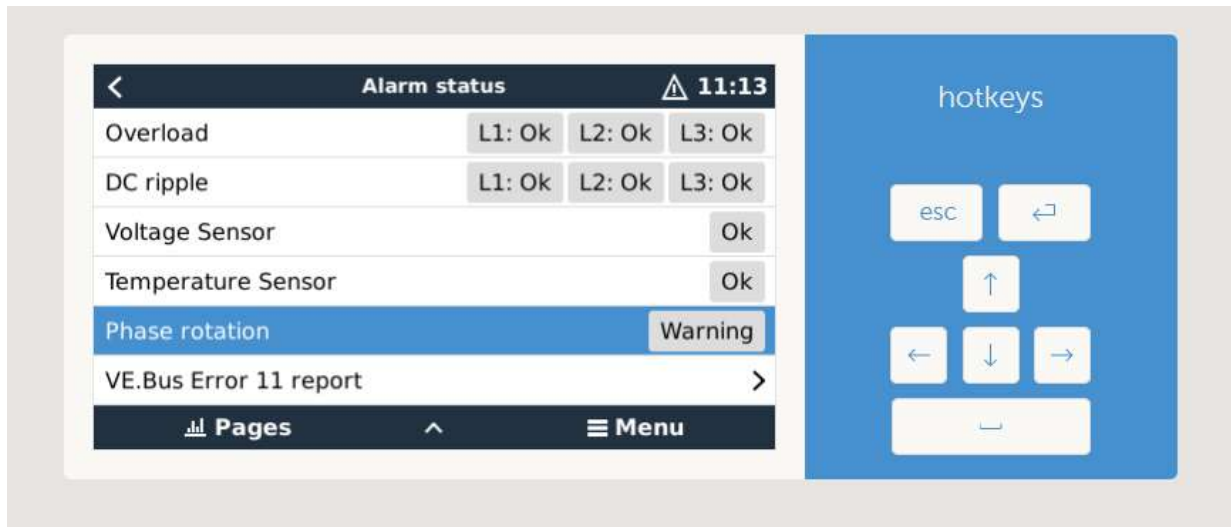

And on the VRM Portal, it is visible on the VE.Bus Alarms & warnings widget on the Advanced page:

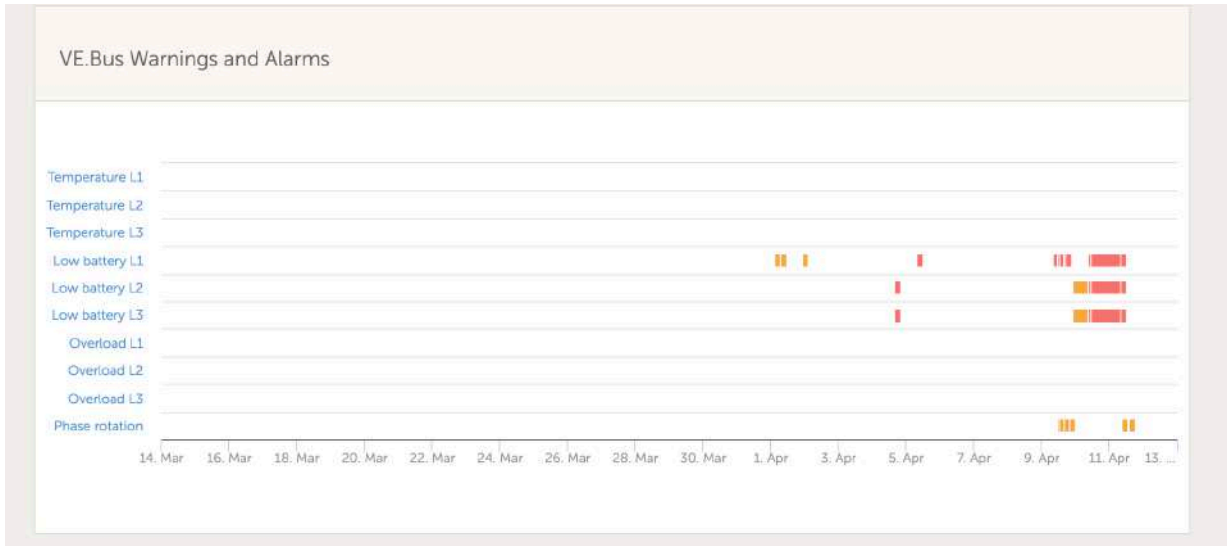

And also it will be listed in the Alarm Log on VRM, and an email will be sent; using [the VRM Alarm Monitoring system](#).

### 7.3. Grid failure monitoring

When this feature is enabled, an alarm is raised when the system hasn't been connected to the AC input configured to be Grid or Shore for more than 5 seconds.



The alarm shows as a Notification in the GUI, and as an alarm on the VRM Portal, and is available on ModbusTCP / MQTT.

Recommend to use for backup systems. But also for yachts or vehicles on shore power.

Note that this settings monitors that the system is connected to grid/shore. Generator monitoring is already available as part of the Generator start/stop function and not part of this.

Do not use this feature in systems that use the Ignore AC Input settings in our inverter/chargers: when the system ignores the AC input, ie runs in island mode, as intended, even though grid is available, it will report a grid failure.

### 7.4. Advanced menu

#### Equalisation

Starts equalisation. See Multi or Quattro documentation for details.

#### Redetect system

Redetects the type of inverter/charger and its features & configuration. Use this feature when, for example, a VE.Bus BMS used to be part of a system, and is no longer.

#### System reset

Restarts the inverter/charger when it has stopped retrying. For example after a (very) heavy overload; or three overloads in a row.

#### ESS Relay test

Shows the status of the ESS Relay test. Only relevant when its an ESS system. See Q9 in the [ESS Manual FAQ](#) for details

# 8. DVCC - Distributed Voltage and Current Control

## 8.1. Introduction and features

Enabling DVCC changes a GX device from a passive monitor into an active controller. The available features and effects of enabling DVCC depend on the type of battery used. The effect also depends on the installed Victron components and their configuration. Two examples:

**Managed CAN-bus batteries:** In systems with a managed CAN-bus BMS battery connected, the GX device receives a Charge Voltage Limit (CVL), Charge Current Limit (CCL) and Discharge Current Limit (DCL) from that battery and relays that to the connected inverter/chargers and solar chargers. These then disable their internal charging algorithms and simply do what they're told by the battery.

**Lead-acid batteries:** For systems with lead-acid batteries, DVCC offers features such as a configurable system-wide charge current limit, where the GX device actively limits the inverter/charger if the solar chargers are already charging at full power, as well as Shared Temperature Sense (STS) and Shared Current Sense (SCS).

This table shows the recommend settings for different battery types:

	Lead-acid	VE.Bus BMS V1 Lithium	VE.Bus BMS V2 <sup>1)</sup> Lithium	Supported 3rd party managed batteries <sup>2)</sup>
Auto-config	No	No	No	2)
System charge current	Yes	Yes	Yes	2)
Should you enable SVS?	Yes	3), 4)	3), 4)	2)
Should you enable STS?	Yes	No	No	2)
Should you enable SCS	Yes	3), 4)	3), 4)	2)
Charge control method	N/A	N/A	N/A	2)
Wire ATC & ATD	N/A	Yes	5)	2)

<sup>1)</sup> DVCC must be enabled for the GX device to control the solar chargers, Inverter RS or Multi RS in a system with a VE.Bus BMS V2.

<sup>2)</sup> Use the [Battery Compatibility manual](#) to see which parameters need to be set and which are set automatically.

<sup>3)</sup> In an ESS system the VE.Bus device is already synced with the solar chargers, so we recommend leaving SVS and SCS off.

<sup>4)</sup> For all other systems: If a BMV or SmartShunt is installed, we recommend enabling SVS and SCS. In all other cases, leave SVS and SCS disabled.

<sup>5)</sup> Solar Chargers, Inverter/Chargers, Multi RS and Inverter RS do not require wiring. All other loads and chargers must be wired and controlled via ATC/ATD.

To enable or disable DVCC, go to Settings → DVCC on the GX device:

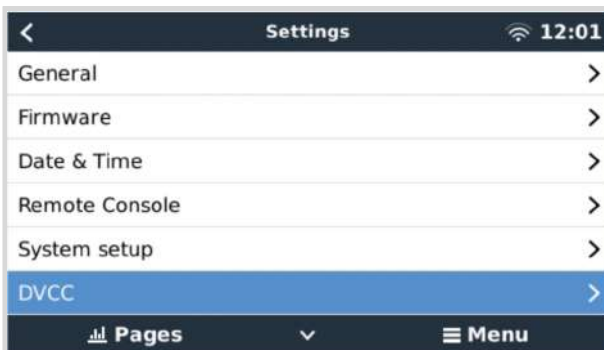

## 8.2. DVCC Requirements

### Battery compatibility

For CAN-bus connected batteries, check the relevant page on the [Battery Compatibility manual](#) to see if enabling DVCC has been tested with your battery type and is supported. If DVCC is not mentioned in notes relating to your battery, do not enable DVCC.

For Gel, AGM, OPzS and other lead-acid batteries, DVCC can be used without any problem. The same is true for Victron Energy Lithium Battery Smart with the VE.Bus BMS, the Lynx Ion + Shunt BMS or the Lynx Ion BMS. DVCC is forced-enabled for the Lynx Smart BMS.

### Firmware versions

Do not use DVCC in cases where these requirements are not met. In all cases we recommend to install the latest available firmware during commissioning. Once running well, there is no need to proactively update firmware without reason. In case of difficulty, the first action is to update firmware.

Required minimum firmware versions:

- Multi/Quattro: 422
- MultiGrid: 424
- Multi RS, Inverter RS and MPPT RS: v1.08
- GX device: v2.12
- VE.Direct MPPTs: v1.46
- VE.Can MPPTs with VE.Direct: v1.04
- Older style VE.Can MPPT Solar Chargers (with the screen) cannot be used: they do not support the new control mechanisms.
- Lynx Ion + Shunt: v2.04
- Lynx Ion BMS: v1.09
- Lynx Smart BMS v1.02

From Venus firmware v2.40, there will be a warning message 'Error #48 - DVCC with incompatible firmware' when one of the devices has an incompatible firmware while using DVCC.

In case of an ESS System, the ESS Assistant needs to be version 164 or later (released in November 2017).

### 8.3. DVCC effects on the charge algorithm

In standalone mode, our inverter/chargers and MPPT solar chargers use their own internal charging algorithm. This means that they determine how long to remain in Absorption, when to switch to Float, when to switch back to Bulk, or Storage. And in those various phases they use the configured parameters in VictronConnect and VEConfigure.

In ESS systems and systems with managed battery (see the [Battery Compatibility manual](#)), the internal charge algorithm is deactivated and the charger then works with an externally controlled charge voltage setpoint. This table explains the different possibilities:

Selection guide			Resulting charge algorithm	
System type	Battery type	DVCC	Inverter/charger	Solar charger
ESS Assistant <sup>1)</sup>	Intelligent battery	On	Battery	Battery
		Off	Don't do this; better enable DVCC	
	Normal battery	On	Internal	Inverter/charger
		Off	Internal	Inverter/charger
Standard	Intelligent battery	On	Battery	Battery
		Off	Don't do this; better enable DVCC	
	Normal battery	On	Internal	Internal
		Off	Internal	Internal

<sup>1)</sup> The ESS Assistant is only installed in a specific type of power system that integrates a grid connection with a Victron inverter/charger, GX device and battery system, not to be confused with an off-grid system such as is used in boats or RVs.

#### Internal

The internal charge algorithm (bulk → absorption → float → re-bulk), and the configured charge voltages are active.

Inverter/charger indicated charge state: bulk, absorption, float, and-so-forth.

MPPT solar charger indicated charge state: bulk, absorption, float and-so-forth (firmware version v1.42 onwards. Earlier versions have a bug that make the MPPT solar charger say "Ext. Control" when it is only being current limited; its internal charge algorithm is still active.).

#### Inverter/charger (applies to MPPTs only)

The MPPTs internal charge algorithm is disabled; instead it's being controlled by a charge voltage setpoint coming from the inverter/charger.

MPPT solar charger indicated charge state: Ext. control.

#### Battery

The internal charge algorithm is disabled and instead, the device is being controlled by the battery.

Inverter/charger indicated charge state: Ext. control.

MPPT solar charger indicated charge state: Ext. control (the LEDs continue to show bulk and absorption, never float).

### 8.4. DVCC features for all systems

These features apply to all types of systems when DVCC is enabled; with or without ESS Assistant, with lead-acid or other normal batteries as well as when an intelligent CAN-bus BMS connected battery is installed:

#### 8.4.1. Limit charge current

Limit charge current is a user-configurable maximum charge current setting. It works across the whole system. MPPT solar chargers are automatically prioritised over the mains/generator.

This setting is available in the Settings → System setup menu on the GX device:



Particulars:

1) If a CAN-bus BMS is connected and the BMS requests a maximum charge current that is different from the user-configurable setting, the lower of the two will be used.

2) This mechanism only works for Victron inverter/chargers including Inverter RS, Multi RS and Solar chargers incl. MPPT RS. Other chargers, such as Skylla-i's are not controlled and also their charge current is not taken into account. The same applies for devices that are not connected to the GX device, such as an alternator. Worded differently: the total charge current of the inverter/chargers and all MPPT solar chargers will be controlled, nothing else. Any other sources will be extra charge current, unaccounted for. Even when installing a BMV or other battery monitor.

3) DC Loads may not be accounted for, unless a SmartShunt or BMV-712 is installed and correctly configured as a [DC meter](#). For example, without the DC load monitor a configured maximum charge current of 50A and DC Loads drawing 20A, the battery will be charged with 30A, not with the full allowed 50A. With the SmartShunt configured as a DC meter, maximum charge current configured at 50A and DC system shunt reports a draw of 25A, then the chargers are set to charge with  $50 + 25 = 75A$ .

If you have one or more shunts configured for "DC system" (when more than one, they are added together), then the DVCC charge current limit compensates for both loads and chargers. It will add extra charge current if there is a load, and subtract it if there is another charger in the DC system. DC "loads" and "sources" are not compensated for in either direction.

4) Current drawn from the system by the inverter/charger is compensated for. For example, if 10A is drawn to power AC loads and the limit is set to 50A, the system will allow the MPPT solar chargers to charge with a maximum of 60A.

5) In all situations, the maximum charge limit configured in a device itself, i. e. the Charge current limit set with VictronConnect or VEConfigure for MPPT solar chargers or inverter/chargers will still be in effect. An example to illustrate this: in case there is only an inverter/charger in the system and in VEConfigure or VictronConnect the charge current is configured to 50A. And on the GX device, a limit of 100A is configured, then the working limit will be 50A.

6) DVCC charge current limits are not applied to DC MPPTs when ESS is enabled with Allow DC MPPT to export. This is to get maximum output from the solar panels for export.

#### 8.4.2. Limit managed battery charge voltage

Some batteries (like BYD and Pylontech) that come from the factory will take some time to settle in, and you may need to run them at a **lower voltage** for the first two weeks or so to help them balance.

This is what Limit managed battery charge voltage is designed for. Enabling this makes it possible to lower the maximum charge voltage until cells have balanced.

Do not use it for any other purpose as it may have unwanted side effects, for example, balancing can fail or not start at all if the charge voltage is set too low, causing the battery cells to become severely imbalanced over time. It is also not possible to set the value above the charge voltage limit (CVL) sent by the battery.

#### 8.4.3. Shared Voltage Sense (SVS)

Works with VE.Bus devices, VE.Direct and VE.Can MPPT solar chargers as well as Inverter RS and Multi RS.

The system automatically selects the best available voltage measurement. It will use the voltage from the BMS or a BMV battery monitor, if possible, otherwise it will use the battery voltage reported by the VE.Bus system.

The voltage displayed on the GUI reflects the same voltage measurement.

Shared Voltage Sense (SVS) is by default enabled when DVCC is enabled. It can be disabled with a switch in Settings → DVCC.

SVS (and DVCC) is force enabled for the Lynx Smart BMS and cannot be changed.

Note that SVS is force-disabled for some batteries. Please see the [compatibility page](#) for your battery.



#### 8.4.4. Shared Temperature Sense (STS)

Select the temperature sensor to use; and the GX device will send the measured battery temperature to the inverter/charger system as well as all connected solar chargers.

Selectable sources for the battery temperature are:

- BMV-702 battery monitor
- BMV-712 battery monitor
- SmartShunt
- Lynx Shunt VE.Can battery monitors
- Temperature inputs on a Cerbo GX (and same for other GX devices that have a temperature input)
- Multi/Quattro inverter/charger
- Solar chargers (if fitted with a temperature sensor)

#### 8.4.5. Shared Current Sense (SCS)

This feature forwards the battery current, as measured by a battery monitor connected to the GX device, to all connected solar chargers.

The solar chargers can be configured to use the battery current for its tail current mechanism that ends absorption when the current is below the configured threshold. For more information about that, refer to solar charger documentation.

This feature only applies to systems that are not ESS and/or don't have a managed battery, since in both of those cases the MPPT is already externally controlled.

Requires MPPT solar charger firmware v1.47 or newer.

## 8.5. DVCC features when using CAN-bus BMS battery

This chapter applies to all systems where an intelligent battery BMS is installed and connected via CAN-bus. Note that this does not include the Victron VE.Bus BMS.

Such intelligent BMS sends the following parameters to the GX device:

1. Charge voltage limit (CVL): the maximum charge voltage that the battery currently accepts.
2. Charge current limit (CCL): the maximum charge current requested by the battery.
3. Discharge current limit (DCL): the maximum discharge current as requested by the battery.

For all three parameters, some types of batteries transmit dynamic values. For example they determine the maximum charge voltage based on cell voltages, state of charge, or for example temperature. Other makes and brands use a fixed value.

Here is the page in the menus showing the parameters:

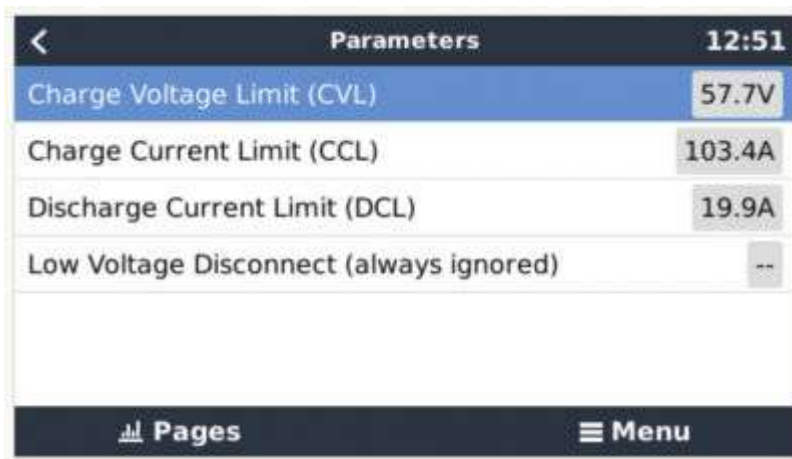

For such batteries, there is no need to wire allow to charge (ATC) and allow to discharge (ATD) connections to the AUX inputs of a Multi or Quattro.

When inverting, i. e. in island mode, Multis and Quattros will shut down when the max discharge current is zero. They will automatically start again as soon as either AC mains returns or when the BMS increases the max discharge current again.

See previous section [Limit charge current \[50\]](#), the user-configurable maximum charge current setting, for details about how the Maximum charge current is used, how it prioritises solar and more.

All above means that setting up charge voltages or charge profiles in VEConfigure or VictronConnect is not necessary and will also have no effect. The Multis, Quattros, Multi and Inverter RS and MPPT Solar Chargers will charge with the voltage as received via CAN-bus from the battery. This also applies to systems with a Lynx Smart BMS connected to a GX device.

## 8.6. DVCC for systems with the ESS Assistant

- The ESS Keep batteries charged mode will only work properly with DVCC enabled.
- A fixed solar offset of 0.4V (value for 48V system, divide by 4 for 12V) is applied when ESS-mode is set to Optimised in combination with the Feed-in excess solar charger power-setting enabled, or when ESS-mode is set to Keep batteries charged.
- For system with ESS mode Optimised and Optimised (with BatteryLife): The system will automatically recharge the battery (from the grid) when the SoC drops 5% or more below the value of 'Minimum SoC' in the ESS menu. Recharge stops when it reaches the Minimum SoC.
- ESS status display in the graphic overview of the GX device: In addition to the charge status (External Control or Bulk/Absorption/Float), the following status can be displayed:
  - #1: Low SoC: discharge disabled
  - #2: BatteryLife is active
  - #3: Charging disabled by BMS
  - #4: Discharging disabled by BMS
  - #5: Slow charge in progress (part of BatteryLife, see above)
  - #6: User configured a charge limit of zero.
  - #7: User configured a discharge limit of zero.
- Note: When DC-coupled PV feed-in excess is enabled with ESS, the DVCC system will not apply the DVCC charge current limit from PV to battery. This behaviour is necessary to allow the export. Charge voltage limits will still apply. Charge current limits set at the individual solar charger device settings level will also still apply.
- When the BMS is disconnected in an ESS system, solar chargers will stop and show error #67 – No BMS (see the [MPPT Solar Charger Error Codes](#) for additional info).

## 9. VRM Portal

### 9.1. VRM Portal Introduction

When connected to the internet, a GX device can be used in combination with the [Victron Remote Management \(VRM\) portal](#), which enables:

- Easy remote access to all statistics and systems status online
- Remote Console on VRM: access and configure your system as if you were standing besides it
- Remote Firmware updates of connected Solar Chargers and other Victron products.
- Use of the [VRM App for iOS and Android](#).

See [Internet Connectivity chapter \[18\]](#) for how to connect the device to the internet.

### 9.2. Registering on VRM

Instructions are in the [VRM Portal Getting Started document](#).

Note that any system will need to first have been able to successfully send data to the VRM Portal. As long as there has been no successful connection, it will not be possible to register the system to your VRM user account. In such case, refer to below Troubleshooting section 5.7.

### 9.3. Datalogging to VRM

Data-logs are transmitted to the VRM Portal over the Internet, if it's available. All related settings are available in the VRM Online Portal menu:



The transmission of the data logs has been designed to work also on bad internet connections. Lines of up to 70% permanent packet loss are still sufficient to get the data out, even if delayed in some cases.

#### Adding an external storage device

When unable to transmit the logs, then the GX device will store them to non-volatile storage (ie. data is not lost on a power loss or reboot).

The GX device has a buffer to store a couple of days worth of logs internally. To extend this period, insert a microSD card or USB stick. You can see the internal storage status in the settings.

Note that, when inserting such storage device, any internally stored logs will automatically be transferred to the inserted stick: no data is lost.

With or without an external storage device inserted, the GX Device will always keep trying to connect to the portal and transmit all backlogged logs. That means that even with months worth of backlog, once it re-acquires an Internet connection, all of the backlog is sent out. The data is sent in a compressed manner: sending a lot of backlogged data will use considerably less bandwidth than sending the data with a continuously available internet connection.

#### Storage device requirements

- Supported file systems for MicroSD cards or USB flash drives are FAT (12, 16, 32), ext3, ext4 and exFAT.
- SD and SDHC type microSD cards of 32 GB capacity and smaller are sold containing FAT12, FAT16 or FAT32. They can be used without a problem, unless they are subsequently re-formatted to an unsupported file system.

### Manually transferring datalogs to VRM

For devices permanently without Internet, it is possible to take the data out, and then upload it manually from a laptop.

1. go to Settings → VRM Portal, and click Eject the storage. Make sure to never just remove the SD-card/USB-stick, this can lead to corruption and data loss.
2. now, remove the storage device and insert it into a computer or laptop that is connected to the internet.
3. open a webbrowser, and navigate to the [VRM Portal](#).
4. Login, and then click the 'Upload GX file' option, and follow instructions:

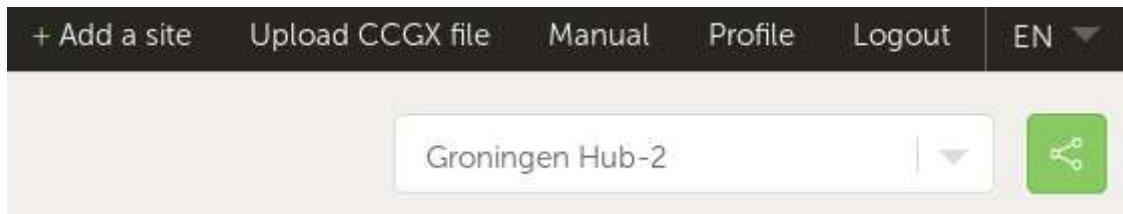

5. Remove the file from the storage device, and then it re-insert it into the GX Device. Note that uploading the same data twice does not cause any problems; but still it is better not to do that.

With a log interval of once per minute, the required storage space roughly amounts to about 25 MB per month, depending on the number of connected products. So with a 1 GB microSD card, you can store about 3 years of backlog. In other words, any microSD card or USB stick should be sufficient to store the 6 months of data which VRM retains.

When the storage device is full, no more data will be logged.

If multiple storage devices are inserted, the GX device will store the data on the one inserted first. When that is removed, it will not use the other one. Instead, it will create an internal backlog buffer. Only inserting a new one will make it switch to using external storage again.

### Network watchdog: auto-reboot



This feature, disabled by default, makes the GX device automatically reboot itself in case it has not been able to connect to the VRM Portal.

Please be careful with enabling this feature on ESS systems: when grid connection is lost, and the GX device reboots, the system can lose power when rebooting takes too long (when grid is present, the Multi's or Quattro's will enter passthru).

## 9.4. Troubleshooting data logging

This chapter explains what to do when the GX Device cannot transmit data to the VRM Portal.

The communication required to send logs to the VRM Portal is:

1. Working DNS
2. Proper IP address
3. Working internet connection
4. Outbound http(s) connection to <http://ccgxlogging.victronenergy.com> on port 80 and 443. Note that should never be an issue, unless on very specialized company networks.

Note that the Cerbo GX does not support a proxy setup. For more details on the required networking, see [here](#).

### Step 1: Update the GX Device to the latest available firmware

[GX Device firmware update instructions](#)

**Step 2: Verify the network and internet connection**

In the menu Settings → Ethernet or Settings → Wi-Fi, check the following:

1. State must be 'Connected'
2. There must be an IP address, that does not start with 169.
3. There must be a gateway
4. There must be DNS servers

For a GX GSM, see the Troubleshooting guide in the GX GSM Menu.

In case the IP address starts with 169, check whether your network has a DHCP server running. 99% of all networks have a DHCP server running and it is enabled by default on all well-known ADSL, cable and 3G routers. If there is no DHCP server running, then configure the ip address manually.

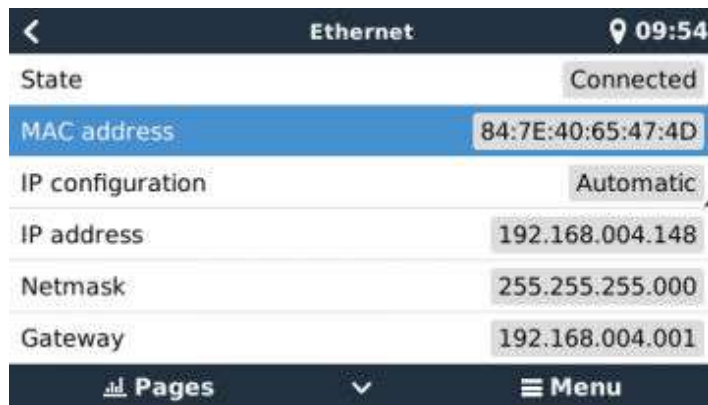
**Ethernet**

When using Ethernet and State shows 'Unplugged', verify that the Ethernet network cable is not faulty: try another one. The two lights at the back of the Cerbo GX, where the Ethernet RJ45 cable plugs in, should be lit or blinking. Two dead lights indicate a connection problem.

**WiFi**

When using Wi-Fi and the menu shows 'No Wi-Fi adapter connected' check the USB connection to the Wi-Fi dongle. Try to remove the dongle and insert it again.

When using Wi-Fi and the State shows 'Failure', it might be that the Wi-Fi password is incorrect. Press 'Forget network' and try to connect again with the correct password.

**Step 3. Verify VRM Portal Connectivity**

Navigate to Settings → VRM online portal, and check the Connection error status:



If a Connection error is shown, the Cerbo GX is not able to contact the VRM database. The connection error will show an error code that indicates the nature of the connectivity problem. Also, details of the error message are shown, to facilitate on site IT experts to diagnose the problem.

- Error #150 Unexpected response text: The http/https call succeeded, but the response was incorrect. This indicates that there is a WiFi or network login page, sometimes called a "captive portal". Such as seen in Airports, Hotels, Marinas or RV campgrounds some times. There is no solution to make the GX device work with a WiFi network that requires such login page and/or accepting of terms of use.
- Error #151 Unexpected HTTP Response: A connection succeeded, but the response did not indicate a successful HTTP result code (normally 200). This might indicate that a transparent proxy is hijacking the connection. See #150 above for examples.
- Error #152 Connection time-out: this could indicate a poor quality internet connection, or a restrictive firewall.
- Error #153 Connection error: this could indicate a routing problem. For details, check the shown error message:



- Error #153 Connection problem, and then specifically an SSL related issue, such as in below screenshot: check the date and time setting of the Gx Device, and also the time zone. And check that your router is not showing a special disclaimer, login or acceptance page, like often seen in airports, hotels and other public wifi.

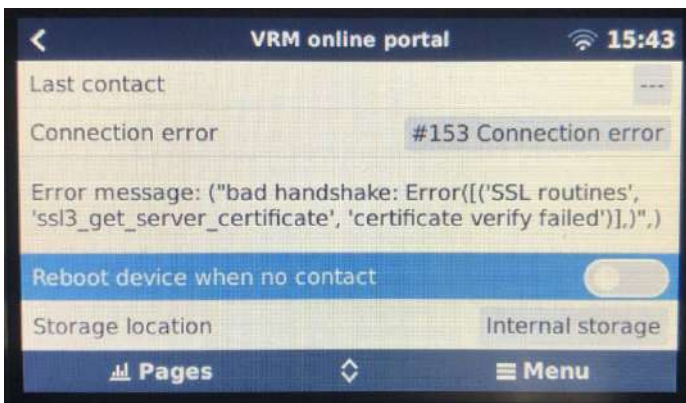

- Error #154 DNS Failure: Make sure that a valid DNS server is configured in the Ethernet or WiFi menu. Typically this is assigned automatically by a DHCP server in a network.

- Error #155 Routing error: VRM is unreachable. This error occurs if an ICMP error is received indicating that no route exists to the VRM server. Make sure your DHCP server assigns a working default route, or that the gateway is correctly configured for static configurations.
- Error #159 Unknown error: this is a catch-all error for errors that cannot be directly categorised. In such cases the Error message will provide information about the problem.

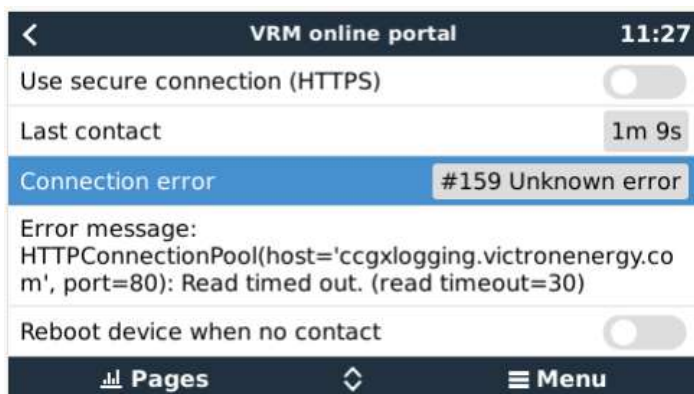

Check 'Last contact'. If this shows dashes, the GX device has not been able to contact the VRM Portal since power up. If it shows a time, but still an error is shown, then the GX device has been able to send data, but has since lost contact.

The 'Buffered items' indicates the number of logs that it has stored to send later. If this is larger than 0, it means that the Cerbo GX can not connect to the VRM Portal. All data is sent using the First in First out principle: the VRM Portal will only show the most up to date information after all old data has been sent.

## 9.5. Analysing data offline, without VRM

In certain cases, for example for very remote sites where there is no internet available, it can be useful to be able to analyse the data without first having to upload it to the VRM Portal.

1. Install VictronConnect on a Windows or Apple laptop
2. Insert the storage device containing the log file(s) in Victron
3. Connect, use the GX Log Converter feature to convert them to Excel sheets.

## 9.6. Remote Console on VRM - Troubleshooting

Follow these steps to trouble shoot Remote Console on VRM

1. Make sure that Logging to the VRM portal works, see chapter 9.3. and 9.4. Without this; Remote Console on VRM will not work.
2. After enabling the Remote Console feature, make sure to set (or disable) the password.
3. Also make sure to restart the Cerbo GX after setting (or disabling) the password.
4. Make sure to update the Cerbo GX to the latest firmware version. The last stability improvement for Remote Console was made in version v2.30.
5. After the restart, check the Remote Console on VRM status shows online or a port number. In case it says offline, or port number 0, the Cerbo GX was unable to connect to the Remote Console server. This is normally caused by a (company) firewall, blocking the connection. The solution is then to configure an exception rule in the firewall.
6. -Verify that your web browser, on which you're using VRM, can access both of below URLs. Click both of the links, to check them. *Note that seeing an Error means that all is OK.* The good error is 'Error response, Error code 405, Method Not Allowed'. If you get a timeout or another (browser) error, there may be a firewall blocking the connection. <https://vncrelay.victronenergy.com> & <https://vncrelay2.victronenergy.com/>

### Technical background

To have Remote Console on VRM working, your web browser and the GX Device need to have a connection between them. This connection is designed such that it doesn't need any special configuration or opening up of firewalls in almost all situations. The 0.1% of situations where it doesn't work out of the box are, for example, large corporate networks with special security, or long range expensive satellite or radio supported networks, such as seen in rural areas of Africa and other remote areas.

When Remote Console on VRM is enabled, the GX Device will open and maintain a connection to any of the servers pointed to by [supporthosts.victronenergy.com](https://supporthosts.victronenergy.com). Which currently resolves to multiple IP addresses (84.22.108.49, 84.22.107.120, 3.25.10.245, 13.244.154.199 or 35.165.124.40, depending on where you are), and likely more in the future. The technology used



is SSH, and it will try to connect using port 22, 80 and 443, only one of them needs to work. The reason for it to try all three is that on most networks at least one of them will be allowed by the local firewall.

Once connected to one the the supporthost servers, that reverse SSH tunnel is waiting to be connected from someone needing the connection. Which can be your browser, or a Victron engineer since this same technology is used for the Remote Support functionality; for more information see above.

When using Remote Console on VRM, the browser will connect to either [vncrelay.victronenergy.com](https://vncrelay.victronenergy.com), or [vncrelay2.victronenergy.com](https://vncrelay2.victronenergy.com), using websockets on port 443. For more details of used connections by the GX Device, see Q15 of the FAQ.

## 10. Marine MFD integration by App

### 10.1. Introduction & requirements

A Glass Bridge is a MFD (Multi-Functional Display) that integrates a boat's systems and navigation status into a large screen or screens at the helm of the vessel, so doing away with multiple gauges, brackets and wiring complications.

A Victron system can be easily integrated into that, as shown in this video:

<https://www.youtube.com/watch?v=RWdEQfYZKEs>

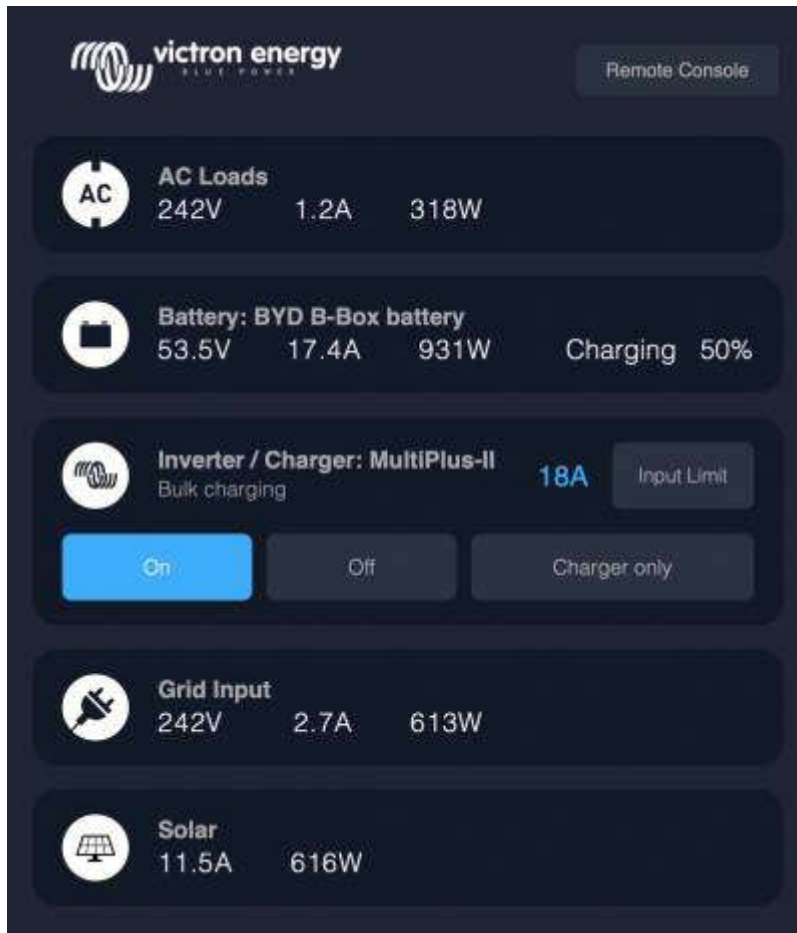

Functionalities:

- Monitor shore power and generator status.
- Monitor battery status for one or more batteries. By using the voltage of for example battery chargers, it can also visualise secondary batteries such as Generator starter batteries.
- Monitor the power conversion equipment: chargers, inverters, inverter/chargers.
- Monitor solar production from an MPPT Solar Charger.
- Monitor AC loads, and DC loads.
- Control shore power input current limit.
- Control the inverter/charger: switch it off, on, or set it to charger-only.
- Optionally open the Victron Remote Console panel; allowing access to further parameters.

Please note that monitoring and control of AC chargers connected via VE.Direct or VE.Can (this applies to Phoenix Smart Chargers and the Skylla series) only works when shore power is connected.

Victron equipment compatibility:

- All Victron inverter/chargers: From a 500VA single phase device up to a large 180kVA three phase-system, including Multis, Quattros, 230VAC and 120VAC models.
- Battery Monitors: BMV-700, BMV-702, BMV-712, SmartShunt, and newer, Lynx Shunt VE.Can, Lynx Ion BMS.
- All Victron MPPT Solar Charge Controllers

Required components:

- Battery system.
- Victron GX Device (all models are compatible: CCGX, Cerbo GX, Cerbo-S GX, Venus GX, and so forth)
- Victron Inverter/charger.
- Victron Battery monitor.
- Ethernet network cable connected between MFD and the GX device
- MFD specific ethernet adapter cable (only for some brands, see detailed information in below links)

## 10.2. Compatible MFDs and instructions

[Instructions for Garmin MFDs](#)

[Instructions for Navico MFDs \(Simrad, B&D, Lowrance\)](#)

[Instructions for Raymarine](#)

[Instructions for Furuno](#)

### Using the App for other purposes

The App as visible on the MFDs, is a HTML5 App, hosted on the GX Device. It can also be accessed from a normal PC (or a tablet), by navigating to with a browser to: <http://venus.local/app/>. Or replace venus.local with the GX IP address.

## 11. Marine MFD integration by NMEA2000

### 11.1. NMEA2000 Introduction

Our GX Devices feature an NMEA 2000-out function: when enabled, the GX Device acts as a bridge: it makes all Battery monitors, Inverter/chargers and other products connected to the GX device available on the NMEA2000 network.

Using that feature, and having the GX Device connected a NMEA2000 network, Marine MFDs can read this data and visualise it to the user. Often in a highly configurable manner.

Use our [VE.Can to NMEA2000 micro-C male cable](#) to connect the GX Device to the NMEA 2000 network.

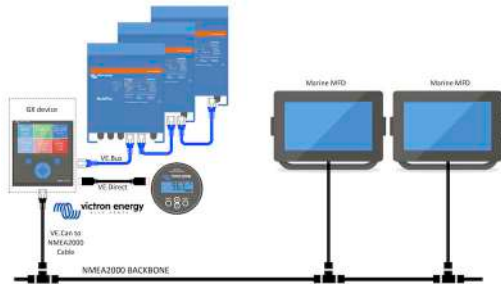

#### Comparison to the App integration

Compared to MFD integration using the App, as explained in the previous chapter, integration via N2K offers a more customisable configuration. The downside of integration via N2K is that there is more work in making such configuration, as well as making sure all PGNs and fields therein are supported and compatible between the Victron system and the MFD.

#### More information

Besides this chapter, make sure to also [read the introduction blogpost](#), as well as our [main Marine MFD Integration document](#).

Besides this chapter, make sure to also read (1) [the introduction blogpost](#), (2) our [main Marine MFD Integration document](#) and (3) the NMEA2000 chapter in the Victron manual for the MFD you are using ([Navico/Simrad/Lowrance/B&G](#), or [Raymarine](#), or [Garmin](#), or [Furuno](#))

Yes that is a lot of reading, but that is basically inherent to NMEA2000: for example some of those MFDs support displaying AC data received over the NMEA2000 wiring, others do not. Some require changing Data instances, others do not, and so forth.

### 11.2. Supported Devices / PGNs

NMEA 2000 defines several messages. Messages are identified by their parameter group number (PGN). A textual description of the message is publicly available on the NMEA 2000 website (<http://www.nmea.org/>).

Detailed specification of the protocol and message definition or part thereof can be ordered online on the NMEA 2000 website.

NMEA 2000 is based on and compatible with SAE J1939. All AC information messages are in the AC status message format as defined in J1939-75. The specification of these messages can be bought on the SAE website (<http://www.sae.org/>).

For a detailed list of PGNs, please refer to our [data communication whitepaper](#).

#### **Inverter/chargers**

All inverter/chargers that connect using a VE.Bus port are supported. This includes Multis, Quattros, MultiPlus-IIs, and other (similar) Victron inverter/chargers.

Data is transmitted out; and its possible to set shore current as well as switch the inverter charger on, off, inverter only and charger only.

The interface has two functions:

- The function, “153 Inverter”, represents the AC-output
- The function “154 AC Input” monitor represents the AC-input

Charger Status messages will be sent by the Inverter function. Both functions have their own network address.

Since both functions transmit the same PGNs, for example an AC Status PGN containing voltage, current and more information, NMEA 2000 data consumers like generic displays will need to be able to make a distinction based on the network address.

Depending on the function belonging to that network address the need to interpret it as either Inverter Input or Inverter Output.

Displays not being capable of doing so will regard the data as belonging to the mains (utility).

The Inverter Output is then interpreted as utility #0 and Inverter Input as utility #1. These default instance numbers can be changed by a network configuration tool if necessary.

Battery temperature as measured by the inverter(/charger) is transmitted as well.

All VREG communications need to be sent to be sent to the address representing the Inverter function. The other one, AC input, does not support VREG requests: that address only transmits AC information related to the AC input.

**Inverters**

Both the range of Inverters connected via VE.Bus as well as our range of Inverters connected using a VE.Direct cable is supported and its information made available on the NMEA2000 network.

**Battery monitors**

Supported. This includes any battery monitor as supported by the GX Device.

**Solar chargers**

Supported. Battery related values as well as the PV Array Voltage & Current is made available on the NMEA2000 network.

**AC chargers**

Phoenix Smart IP43 Charger 120-240V and 230V models are supported. Only the 120-240V model allows to be remotely controlled (on/off and input current limit) from a compatible MFD.

**Tank level data**

Supported. Tank levels measured by the GX Device are transmitted using PGN 127505 Fluid Level. The Device instance as well as the Data instance, for this PGN called the Fluid instance, are both automatically numbered for each tank reading. The first tank is assigned number 0, the second tank is assigned number 1, and so forth.

**Other data and product types**

Not supported. Above explicitly mentioned types are the only ones now supported. For example data from a charger (such as the Phoenix Smart Charger connected via VE.Direct) is not supported and not expected to be supported soon.

**11.3. NMEA2000 Configuration**

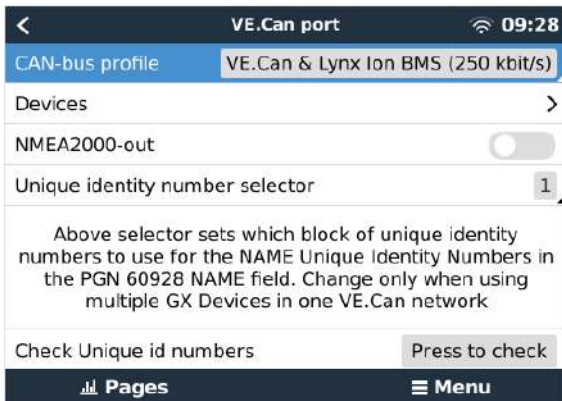

**Table 1.**

Setting	Default	Description
CAN-bus Profile	VE.Can	Defines the type & baudrate of the CAN-bus network. To use in combination with NMEA2000, make sure to choose one of the profiles that include VE.Can and is at 250kbit/s
NMEA2000-out	Off	Enables and disabled the NMEA2000-out function
Unique identity number selector	1	Selects the block of numbers to use for the NAME Unique Identity Numbers in the PGN 60928 NAME field. For the GX Device itself, and when NMEA2000-out is enabled, also for the virtual-devices. Change it only when installing multiple GX Devices in the same VE.Can network. There are no other reasons to change this number. For more details regarding the Unique identity number, read the last section in this chapter.

Setting	Default	Description
Check unique numbers		<p>Searches for other devices that use the same unique number. When the search is completed it will respond with either an OK, or the text :</p> <p><i>There is another device connected with this unique number, please select another one.</i></p> <p>Note that there is normally no reason to use this function: the GX Device automatically and continuously checks uniqueness of the numbers in use, and will warn when in case there is a conflict. This setting is made available to quickly confirm that everything is OK after changing the setting.</p>

## 11.4. NMEA2000 Configuring device instances

The Devices submenu gives access to a list showing all detected Devices on the VE.Can / NMEA-2000 network:

VE.CAN devices		11:04
Cerbo GX [500]	Device#	0
Hub-1 [1514]	Device#	0
MultiPlus 24/3000/70-16 [1516]	Device#	0
MultiPlus 24/3000/70-16 [1517]	Device#	0
vlink [1518]	Device#	0
BlueSolar Charger MPPT 75/50 [1523]	Device#	0

Buttons: Help, Edit

Each entry first shows the name - either the product name as in our database, or when configured, the custom name as configured during installation.

Then, between the square brackets, the Unique Identity Number is shown.

On the right, you can see the VE.Can Device Instance which is the same as the NMEA-2000 Device Instance.

Press enter to Edit that Device Instance. Or, press the right-key to go one step deeper in the menu structure, to a page that shows all generic data available for that device:

BlueSolar Charger MPPT 75/50 [1523]		11:09
Model Name	BlueSolar Charger MPPT 75/50	
Custom Name		
Careful, for ESS systems, as well as systems with a managed battery, the CAN-bus device instance must remain configured to 0. See GX manual for more information.		
Device Instance	0	
Manufacturer	358	
Network Address	36	
Firmware Version	v1.49	
Serial Number	0001523	
Unique Identity Number	1523	

Buttons: Pages, Menu

## 11.5. NMEA2000-out technical details

### 11.5.1. NMEA2000 Glossary

Here is a glossary to help with the interpretation of this text:

- Virtual-device: a Battery Monitor, Inverter, or other Victron device that does not have a CAN-bus port by itself, made available “virtually” on the CAN-bus by the NMEA2000-out function of the GX Device.
- CAN-bus: the VE.Can port on the GX Device, that, in the context of this chapter, is most likely connected to a NMEA2000 network.
- NMEA2000-out function: the software feature in the GX Device, which is described in this chapter.
- NMEA2000: Marine CAN-bus protocol, based on J1939.
- Instance: there are many types of instances, and explained in detail below.
- J1939: A set of standards defining a CAN-bus protocol, defined by the SAE organisation.
- Address Claim procedure (ACL): a mechanism, specified by J1939 and used in NMEA2000, which used by devices on the network to negotiate and assign each device on the network a unique network addresses. Its is a number from 0 to 252. There are three special network addresses defined:
  1. 0xFD (253) - Reserved
  2. 0xFE (254) - Unable to claim address - for example when all others are in use
  3. 0xFF (255) - The broadcast address

### 11.5.2. NMEA2000 Virtual-devices

When the NMEA2000-out feature is enabled, the GX Device acts as a bridge: it will make each Battery monitor, Inverter/charger or other device that is connected, available individually on the CAN-bus.

Individually, as in each with its own network address, its own device instance, function codes, and so forth.

For example, a GX Device with two BMVs connected on a VE.Direct port and an inverter/charger connected using VE.Bus, will make the following data available on the CAN-bus:

**Table 2.**

Address	Class	Function	Description
0xE1	130 (Display)	120 (Display)	The GX Device itself
0x03	35 (Electrical generation)	170 (Battery)	The 1st BMV
0xE4	35 (Electrical generation)	170 (Battery)	The 2nd BMV
0xD3	35 (Electrical generation)	153	The inverter/charger (AC-output)
0xD6	35 (Electrical generation)	154	The inverter/charger (AC-input)

### 11.5.3. NMEA2000 Classes and functions

As per NMEA2000 specification, these define the types of senders and devices connected to the CAN-bus. Classes are the main categories, and functions specify it to a further detail.

### 11.5.4. NMEA2000 Instances

NMEA2000 defines three different instances:

1. Data instance
2. Device instance
3. System instance

For all Battery monitors and other devices that the GX Device makes available on the CAN-bus, each of the above types of instance is available, and can be individually configured.

Per virtual-device, there is one Device instance and one System instance. And depending on the type of the virtual-device, there are one or multiple Data instances.

For example, for a BMV-712 there are two data instances, one “DC Instance” for the main battery, and another one for the Starter battery voltage.

How to configure the instances depends on the equipment and software that is used to read them from the CAN-bus. Examples of equipment and software meant here are MFDs such as from Garmin, Raymarine or Navico; as well as more software oriented solutions from for example Actisense and Maretron.

Most of those solutions identify parameters and products by requiring unique Device instances, or using the PGN 60928 NAME Unique Identity Numbers and do not rely on the data instances to be globally unique. There are, however, a few exceptions: for [Raymarine](#) and [Furuno](#) MFDs the data instance needs to be changed in order to properly show data. Please refer to the [MFD integration page](#) for more details.

The NMEA2000 specification specifies the following: “Data instances shall be unique in the same PGNs transmitted by a device. Data instances shall not be globally unique on the network. Field programmability shall be implemented through the use of PGN 126208, Write Fields Group Function.”.

In other words, data instances need to be unique only within a single device. There is no requirement for them to be globally unique – the only exception is “Engine Instance” that at least for now, to cope with legacy devices, needs to be globally unique (e.g. Port = 0, Starboard = 1). For example, some of our BMV Battery monitors can measure two voltages, one for the main battery, and one for the starter battery, and that's where data instancing is used. Similar for multiple-output battery chargers. Note that there is no need for the installer to change those data instances, as those products are pre-configured to transmit the relevant PGNs with unique data instances (Battery instance & DC Detailed instance, in this case).

**WARNING:** whilst it is possible to change the data instances, changing them on a Victron devices will render that device impossible to read correctly by other Victron devices.

A note about the Device instances: it is not necessary to assign a unique device instance to each device on the CAN-bus. Its no problem for a battery monitor and a solar charger to both be configured with (their default) Device instance 0. Also when having multiple battery monitors or solar chargers, it is not always necessary to assign each of them a unique device instance. If at all necessary, they only need to be unique between the devices that use the same Function.

And note that changing the Device instance on a Victron device can change its operation, see below.

### System instances

As per NMEA2000 specification, this instance is a 4-bit field with a valid range from 0 to 15 that indicates the occurrence of devices in additional network segments, redundant or parallel networks, or sub networks.

The System Instance Field can be utilized to facilitate multiple NMEA 2000 networks on these larger marine platforms. NMEA 2000 Devices behind a bridge, router, gateway, or as part of some network segment could all indicate this by use and application of the System Instance Field.

### The ECU instance and Function instance

In some documentation and software tools, yet other terminology is used:

- ECU Instance
- Function Instance
- Device Instance Lower
- Device Instance Upper

Here is how they all relate: the *ECU Instance* and *Function Instance* terminology originates from the SAE J1939 and ISO 11783-5 specification. And they do not exist in the NMEA2000 definition. However, they all do define the same fields in the same CAN-bus messages which NMEA2000 defines as *Device instance*.

In more detail: the field that J1939 defines as ECU Instance is in the NMEA2000 specification renamed to *Device Instance lower*. The Function Instance is renamed to *Device Instance Upper*. And together they form the *Device Instance*, an NMEA2000 definition.

While using different terms, those fields are the same fields in both standards. Device Instance Lower being 3 bits in length, and Device Instance Upper 5, together 8 bits. Which is the one byte being the NMEA2000 Device Instance.

### The Unique Instance

The *Unique Instance* is one more word used to describe almost the same information. It's used by Maretron, and can be made visible in their software by enabling the column. The Maretron software itself chooses between Device Instance and Data Instance.

## 11.5.5. NMEA2000 Changing Instances

### Data instance

Even though we recommend to not change data instances (see explanation and WARNING above), it is possible to change them.



There is no option within Venus OS to change them - a third party tool is required and the only tool that we know can do that is Actisense NMEA2000 reader.

To change the Data instances, see [this document](#).

**Device instance**

To change the Device instances, see [this document](#).

WARNING: these (Victron-)features depend on the Device Instance:

1. For an [ESS system](#) with Solar chargers connected on a VE.Can network, those Solar chargers must remain to be configured to their default Device instance (0) for proper operation. This does not apply to VE.Direct-connected Solar Chargers made available on the CAN-Bus as a Virtual-device, using the NMEA2000-out function. Unless the Device instance of the GX Device is re-configured to another Device Instance. Which is technically possible but not advised and also never required. But in that situation the chargers must be configured to the same instance as the GX Device.
2. For systems with managed batteries, the same.
3. For both Solar chargers, as well as AC-Connected battery chargers, when connected in a VE.Can network, they will synchronise their operation. Charge state and such. For that function to work, all chargers must be configured to the same device instance.

In summary, for the majority of systems we recommend to leave the Device instance to its default, 0.

**11.5.6. PGN 60928 NAME Unique Identity Numbers**

The GX device will assign an individual Unique Identity Number to each virtual-device. The number assigned is a function of the *PGN 60928 NAME Unique Identity Number block* aka *Unique device number for VE.Can* as in above screenshot, as configured in the settings of the GX Device.

This table shows how changing that setting translates into the virtual-devices as made available on the CAN-bus:

**Table 3.**

configured Unique Identity block:	1	2	3	4
GX device	500	1000	1500	2000
1st virtual-device (for example a BMV)	501	1001	1501	2001
2nd virtual-device (for example another BMV)	502	1002	1502	2002
3rd virtual-device (for example a third BMV)	503	1003	1503	2003

## 12. RV-C Support

### 12.1. RV-C Introduction

Starting with Venus OS firmware v2.90, Victron supports the RV-C protocol.

#### What is the RV-C protocol?

The RV-C (Recreation Vehicle-CAN) protocol is to RVs what NMEA 2000 (also known as N2K) is to boats: a communication protocol based on CAN-bus (Controller Area Network bus) and used primarily in RVs in the US to enable RV devices and appliances to communicate and work together.

There are two basic functions, RV-C out and RV-C in.

- RV-C out allows control and monitoring of compatible Victron devices from a RV-C control panel.
- RV-C in allows receiving data from one or more compatible RV-C devices to be displayed on the GX device.

In summary, when this feature is enabled with the GX device connected to an RV-C network, an RV-C control panel can read Victron data, e.g. from a BMV or an inverter/charger and display it to the user or even control some of them. Compatible RV-C devices are displayed on the GX unit at the same time.

RV-C is built upon [SAE J1939](#).

### 12.2. Limitations

#### VE.Can devices

The RV-C and VE.Can protocols are not compatible with each other: a VE.Can port on a GX device can be configured to the VE.Can profile or to the RV-C profile, not both at the same time.

Using a GX device with just one fully functional VE.Can port means that there is a limitation to what devices can be used in the system when connection to RV-C is a requirement.

Typical RV-related products, which therefore cannot be used in the situation described above:

- the Lynx Smart BMS cannot be used as it needs to be connected via VE.Can. Use a VE.Bus BMS instead (connects to the VE.Bus port).
- the Lynx Smart Shunt cannot be used, use a SmartShunt instead (connects via VE.Direct).
- the Wakespeed alternator regulator cannot be connected to the monitoring by the GX device.
- higher power MPPT charge controllers must be connected using their VE.Direct connection. Not on a VE.Can network.

Depending on the system, this currently also limits the selection of a suitable GX device:

- Color Control GX (CCGX): has only one VE.Can port, thus it can be configured for either VE.Can or RV-C, not both. And because of this you can't for example make a system with a Lynx Smart BMS (which need to be connected on a VE.Can port) and have it connected to RV-C at the same time.
- Cerbo GX & Cerbo-S GX: current generation has only one (fully functional) VE.Can port. Same as above, it's either VE.Can or RV-C, not both.

In mid-2023 we expect the launch an improved Cerbo GX revision with two fully functional VE.Can ports instead of one fully functional and one limited to BMS-Can only.



Please note that the BMS-Can port on the Cerbo GX is limited and cannot be used as RV-C port.

- Venus GX: has two VE.Can ports. So can be connected to both, VE.Can and RV-C networks at the same time.

#### Instance related limitations

All 'instances' are hard-coded:

- Battery Instances are hard coded to 1 (typical 'house battery') and 2 (Starter), where appropriate
- Device instances are hard coded to 1 unless specified otherwise in the DGN table.

The one exception to this are Tank monitors, which map the Victron usage to the RV-C tank instances (i.e. Gray = Gray, Water = Water, etc.).

Outside of tanks, the ramification of this is that only a single physical representation of a given device is supported. Only one MPPT, only one inverter/charger, etc.

## 12.3. Supported Devices

Venus v2.90 adds RV-C out support for the following products:

- VE.Bus Inverter/Charger, i.e. MultiPlus/Quattro: the inverter and charger part can be controlled separately (on/off) from RV-C. Also shore input current limit can be set.
- Phoenix Smart IP43 Charger 120-240V: Can be activated/deactivated (on/off) via RV-C. Also shore input current limit can be set. The Phoenix Smart IP43 Charger 230V cannot be controlled and is read-only.
- Skylla-i and Skylla-IP44/IP65
- Phoenix VE.Direct Inverter
- Phoenix Inverter Smart and Inverter RS
- Solar chargers incl. MPPT RS
- Batteries: BMV, SmartShunt, Lynx Shunt, Lynx Ion BMS, Lynx Smart BMS
- Tanks:
  - Tank level senders connected to the tank level input of the GX device
  - Tank level senders connected to a GX Tank 140
  - Tank level senders connected to the VE.Can and/or NMEA 2000 port of the GX device

We also support RV-C in data for:

- RV-C tank sensors
 

Please note that the Garnet SeeLevel II 709 does not have absolute tank level and tank capacity. Therefore we only show relative level. Tanks from another GX device will have absolute level and capacity, but cannot be configured through RV-C.
- RV-C batteries: Lithionics is the only supported RV-C battery (including DVCC support)

See appendix for advanced parameters and RV-C programming.

## 12.4. RV-C Configuration

The configuration for RV-C is done via the GX device.

1. Open the remote console and go to Settings → Services → VE.Can ports → CAN-bus profile.
2. Open the CAN-bus profile and select the RV-C (250 kbit/s) profile.
3. The RV-C profile will start working and the previously selected profile will shut down (associated equipment like VE.Can devices become unavailable in the GUI).

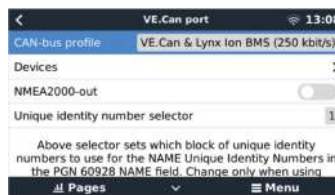

## 12.5. Garnet SeeLevel II 709-RVC & Victron GX device support

With RV-C support in Venus OS it is also possible to use the Garnet SeeLevel 709-RVC and display its data on the GX device and VRM. All 709-RVC models and the SeeLevel Soul are compatible with the GX.

Note the limitations as described in [section 12.2. \[69\]](#). This means that when using a CAN-bus port on the GX device for RV-C, it cannot be used for other purposes at the same time, such as the common VE.Can and NMEA 2000 features. It's either VE.Can/N2K or RV-C, unless it's a Venus GX which has two full VE.Can ports. If this limits further use of the GX device too much in terms of connectivity via VE.Can, it is recommended to use the Garnet SeeLevel 709-N2K instead.

Also note that tank levels displayed on the Victron GX will be in percentage, not actual volume in liters, gallons, or any other unit of volume.

### 12.5.1. Wiring the Garnet SeeLevel II 709-RVC tank level sensor to a GX device

Before connecting to a GX device, ensure that the Garnet SeeLevel 709-RVC has been installed and configured correctly according to Garnet's installation instructions.

While the VE.Can port requires an RJ45 connector, the Garnet SeeLevel panel features either a multi-pin RV-C connector or wired connection with one black, one blue and one white wire each. In order to be able to connect both together, an adapter cable must be built according to the pin assignment in the table below.

A commercially available CAT5 Ethernet cable is best suited for this, whereby one of the two ends is first cut off and then connected to the Garnet panel.

Garnet panel wire colour code	RV-C connector	Victron VE.Can RJ45	CAT5 Ethernet wire colour code	Signal
Black	4	3	green/white	Ground
Blue	3	8	brown	CAN-L
White	2	7	brown/white	CAN-H

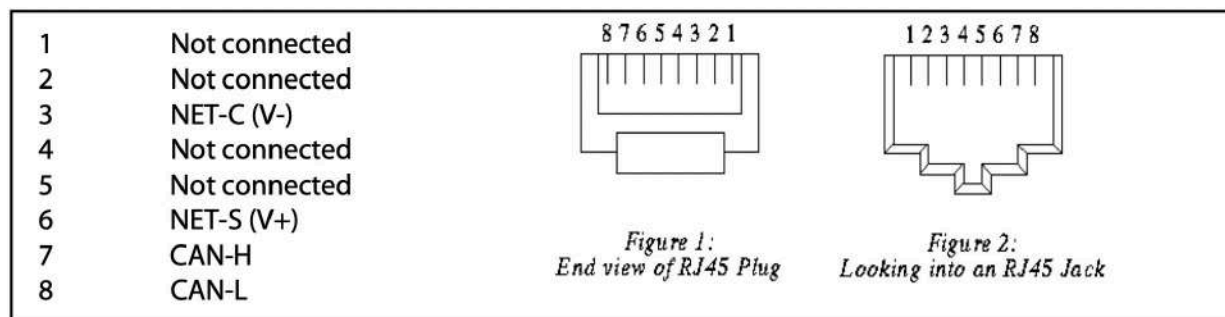

Victron VE.Can pinout

### 12.5.2. Installation and configuration

1. Route the cable from the Garnet panel to the GX device.
2. Make sure both the Garnet and the GX device are powered off.
3. Connect the RJ45 plug to the VE.Can port of the GX device and the other end of the adapter cable to the Garnet panel.
4. Make sure the bus termination is correct. For the GX device: Use the included blue [VE.Can RJ45 terminator](#). Proper bus termination is mandatory for the Garnet SeeLevel if it is the only RV-C device.
5. Once everything is installed correctly, turn on both devices.
6. Proceed with the RV-C configuration as explained in the [RV-C Configuration chapter \[70\]](#) to properly configure the VE.Can port for the RV-C profile.

## 13. Wakespeed WS500 support

### 13.1. Introduction

The WS500 is an external smart alternator regulator with CAN-bus and NMEA 2000 communication, which is especially applicable in Marine and RV applications. The Wakespeed WS500 is supported by Venus OS and offers the possibility to monitor the performance of your alternators via a GX device.

### 13.2. Requirements

Necessary requirements for the integration of the WS500 are:

1. VenusOS firmware v2.90 or higher installed on your GX device
2. Wakespeed WS500 firmware 2.5.0 or higher installed on the WS500 controller
3. The WS500 must connect to the VE.Can port of the GX device. It is not possible to monitor the WS500 when connected to the BMS-Can port of a Cerbo GX.

### 13.3. Wiring the WS500 to VE.Can

Both, the WS500 and VE.Can, use RJ45 connectors for their CAN ports.

However, both have different pin outs. This means that a normal (straight UTP cable) network cable cannot be used. A crossover cable is required. This crossover cable must be made by yourself. The following diagram reflect the pin out of the two devices.

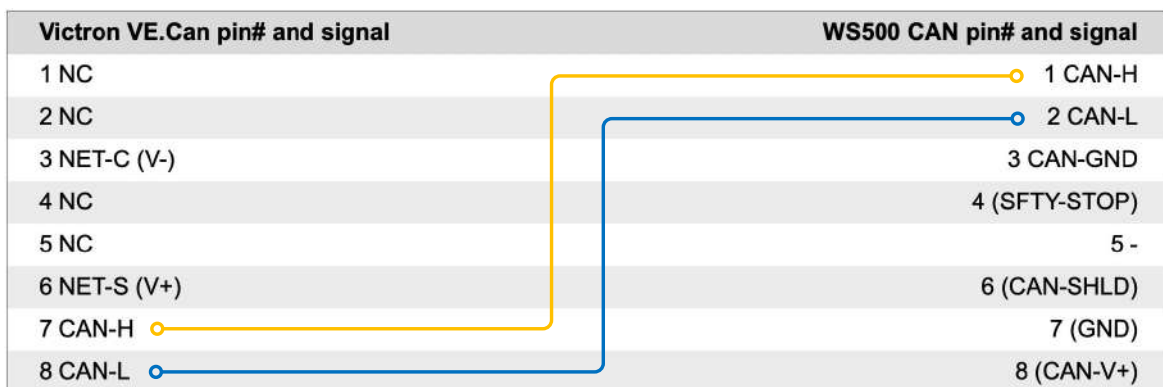

The important pins to look at are pin 7 and pin 8 for CAN-H and CAN-L on the VE.Can side and pin 1 and 2 for Can-H and CAN-L on the WS500 side.

Therefore a cable is needed where pin 1 and 2 on one side are connected to pin 7 and pin 8 on the other side. Pin 7 goes to pin 1 and pin 8 to pin 2.

The RJ45 connector with pin 7 and 8 on one end connects to the VE.Can port of the GX device. The other end of the cable with pin 1 and 2 connects to the WS500 controller. Both sides must be terminated.

The cable colors do not matter for the do-it-yourself cable. Wakespeed also offers a ready-configured cable with a blue RJ45 connector on one end that must be connected to the VE.Can port.



Please note that the black terminators supplied by Wakespeed and the blue terminators supplied by Victron are not interchangeable. Therefore: insert the Victron terminator on the Victron side of the network, and insert the Wakespeed terminator into the Wakespeed.

### 13.4. Wiring Example

The example below shows an overview of the recommended wiring based on an installation with a Lynx Smart BMS, Lynx Distributors and a Cerbo GX.

The correct placement of the alternator shunt (not to be confused with the shunt of the BMV or SmartShunt) is important here for the correct connection of the current sense wire.

For complete wiring between the WS500 and alternator, see the WS500 and the alternator manual.

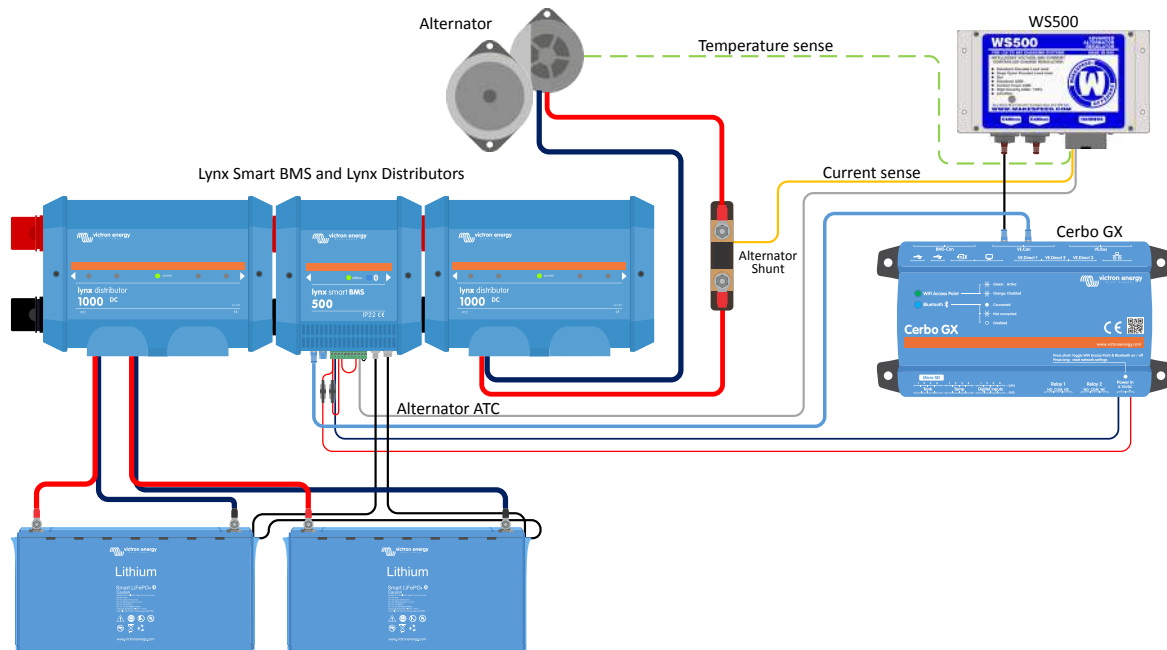

### 13.5. GX device user interface for WS500

Once the WS500 is connected to the GX device, the Device list contains an entry for the regulator.

The WS500 menu then provides the following information and data:

- **Output:** voltage, current and power as reported from the alternator regulator
- **Temperature:** the alternator temperature as measured by the WS500 temperature sensor
- **State:** the charging state of the WS500
  - Off when not charging
  - Bulk, Absorption or Float when the WS500 is using its own charging algorithm
  - External Control when controlled by a BMS such as Lynx Smart BMS
- **Network Status:**
  - Standalone, if the regulator is working on its own
  - Group Master, when it is supplying charging targets to another WS500 device
  - Slave, when it is taking charging directions from another device such as a WS500 or a BMS
- **Error:** reflects any error state the WS500 might be in. The details of all error codes and messages can be found in the Wakespeed Configuration and Communications guide. See also the appendix for error #91 and error #92
- **Field Drive:** report on the % of field drive being sent by the WS500 to the alternator on the field connection
- **Speed:** the speed in RPM at which the alternator is spinning. This is as reported by the stator feed and if this is wrong can be adjusted by setting the Alt Poles option within the Wakespeed SCT configuration line
- **Engine Speed:** reported in RPM. This is reported by either
  - calculation based on the alternator speed and the Eng/Alt drive ratio as set by the SCT configuration line
  - NMEA 2000, if the WS500 is receiving engine RPM from PGN127488
  - J1939, if the WS500 is receiving engine RPM from PGN61444

It is also possible to create a custom name for the WS500 in the Device menu. This triggers the WS500 to update the \$SCN configuration line of the regulator.

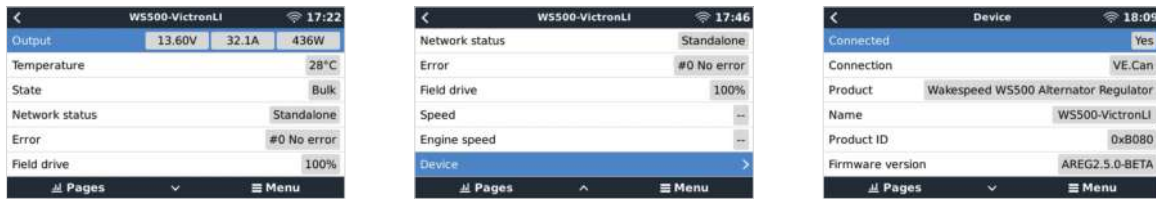

### 13.6. VRM Portal

The data from the WS500 that can be displayed on our [VRM portal](#), is current, voltage and temperature.

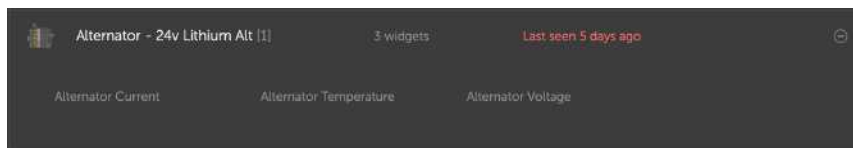

Currently 3 widgets are available on VRM

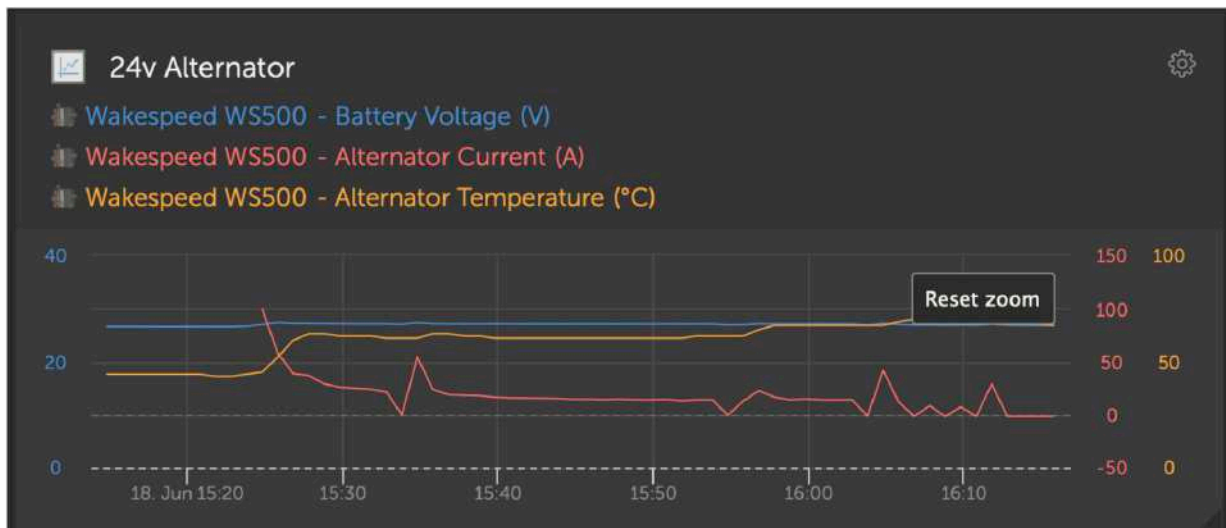

VRM custom widget showing WS500 voltage, current and temperature

### 13.7. Troubleshooting

For further assistance and troubleshooting please contact Wakespeed support directly.

#### 13.7.1. Error code #91 and #92

Venus OS will report all errors that can be generated by the WS500 as defined within the Wakespeed Communications and Configuration guide. In systems with integrated BMS, the following errors are critical as long as the events are active and require special attention.

- **#91: Lost connection with BMS;** the WS500 has lost communication with the BMS and will drop into the configured get home mode. As soon as communication is restored with the BMS, it will revert to following the charging goals as set by the BMS.
- **#92: ATC disabled through feature IN;** the BMS has signalled a charge disconnect event through the feature in wire and the WS500 has therefore reverted to an Off status.

#### 13.7.2. Current field contains two dashes

If the current field and therefore power field contain two dashes, then the system is not receiving any current readings from the WS500. This is likely due to one of the following reasons:

- The shunt is configured as being located at the battery and therefore the WS500 does not have any alternator current reading. Check the configuration of the shunt through the Wakespeed CST terminal output. If the CST line has a ShuntAtBat? Set to 1, then this will be the reason.
- The shunt is not connected to the WS500. Make sure a shunt is connected as per WS500 installation instructions.
- The system has been told to ignore the shunt sensor. Check the Wakespeed \$SVC terminal output. If the \$SVC line is reporting an Ignore Sensor configuration, which includes ignoring the Local Current Shunt, then this would be why. Modify the Ignore Sensor line through the Wakespeed \$SCA configuration line.



## 14. Mopeka Pro sensor support

### 14.1. Introduction

Mopeka Pro Check-Water and Pro Check-Sensor LPG support has been added to Venus OS. These ultrasonic sensors use BLE (Bluetooth Low Energy), a wireless technology that allows devices to be networked within a range of about 10 meters, while consuming significantly less power compared to ordinary Bluetooth technology.

The Mopeka Pro sensors feature ultrasonic sensing for water and LPG tanks in horizontal or vertical cylinders and mount to the bottom of those tanks by magnets. The liquid level, temperature and sensor battery voltage is streamed wirelessly to the GX device.

Note that the Cerbo GX & Cerbo-S GX built-in Bluetooth connection is disabled when the internal CPU temperature exceeds 53 degrees C (influenced by load and/or ambient temperature). **For reliable operation it is necessary to use a USB Bluetooth adapter.**

USB Bluetooth adapters that have been tested and known to work:

- Insignia (NS-PCY5BMA2)
- Logilink BT0037
- TP-Link UB400(UN)
- Ewent EW1085R4
- Laird BT820
- Laird BT851
- Kinivo BTD-400
- Ideapro USB bluetooth adapter 4.0

A list of additional adapters that are also being tested, as well as adapters that have been tested and are known not to work, is available here: <https://community.victronenergy.com/questions/112834/connect-ruuvi-to-ccgx.html>

### 14.2. Installation

The installation of the Mopeka Pro sensor is very simple. First, however, the sensor must be installed according to Mopeka's installation instructions and configured via the Mopeka Tank app (available in Google Play and Apple App Store). Then the installation and configuration is done in the GX device as described below.

1. Make sure that Bluetooth is enabled in the Bluetooth sensors menu (enabled by default).
2. Go to Settings → I/O → Bluetooth sensors menu.
3. Move the Enable slider to the right to enable Bluetooth sensors.
4. To find your Mopeka Pro sensor, scroll down until you see them.
5. To activate the sensor, move the slider to the right. It should now appear on the Device List.
6. Repeat steps 1..5 for more than one sensor.

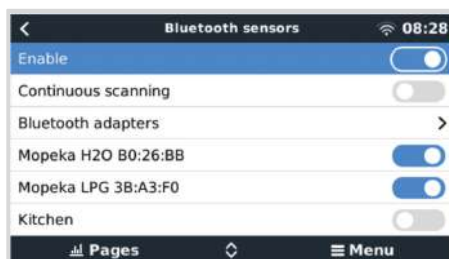

## 14.3. Configuration

1. Go to the Device List menu.
2. Scroll up or down and select the appropriate sensor.
3. Press the right arrow key or space bar on that sensor to open up the sensor Setup menu.
4. Scroll down to Setup and right arrow key or space bar again to open up the sensors Setup menu.
5. In the Setup menu you can change the tank capacity, select the liquid type and volume unit, set up calibration values for empty and full tank levels and read the actual sensor value.
6. After setup, go back to the Sensor overview menu.
7. Scroll down, select Device and press the right arrow key or space bar again to open up the device settings menu.
8. In the Device menu you can assign a custom name to the sensor and read out some additional device information.
9. Repeat steps 1..8 if you want to set up additional sensors.



## 14.4. Tank level monitoring

Tank levels can be monitored at various locations within the GX environment.

- Device List of the GX device
- Sensor overview menu of the GX device
- Graphical overview of the GX device
- VRM Dashboard
- VRM advanced menu widgets
- VRM App widgets

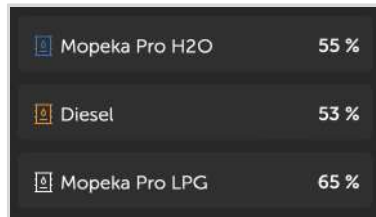

## 15. Digital Inputs

The Cerbo GX digital inputs are shown in the [overview of connections](#). [2]

The inputs are non-isolated. They operate at 3V3 levels, and can withstand up to 5V input. Each input has an internal 10k pull-up resistor to 3V3. We recommend wiring it to a potential free relay or otherwise open collector/optocoupler output.

### 15.1. Configuration

Each of the digital inputs can be configured as one of a number of predefined sensors that can also be configured as alarms.

Note Pulse Meter is not supported in Cerbo GX.

The possible configurable functions are:

Function	States
Door alarm	Open/Closed
Bilge pump	On/Off
Bilge alarm	Ok/Alarm
Burglar alarm	Ok/Alarm
Smoke alarm	Ok/Alarm
Fire alarm	Ok/Alarm
CO2 alarm	Ok/Alarm
Generator	Running/Stopped

The function of each input can be configured in the GUI under Settings → I/O → Digital Inputs.



Once the input is configured for its intended purpose, it will show up with other devices.



Other parameters related to that function can be configured by entering the device menu and selecting Setup.

For sensors and alarms, you can decide whether the input should be treated as an alarm condition, whether the labels should be inverted, and whether the logical levels should be inverted.

- To swap the labels attached to the alarm, set Inverted to on.
- If a logical low input (0V) should be considered a positive condition, set Inverted alarm logic to on.



## 15.2. Read-out of digital inputs via Modbus-TCP

The values/states of the digital inputs are available on Modbus-TCP. For more details about this, please download a copy of the document "Modbus-TCP register list" from our website. And see our [Modbus-TCP FAQ](#).

## 16. GX - Generator auto start/stop

### 16.1. GX - Generator auto start/stop

#### Introduction

An internal relay on a [GX device](#) (eg Cerbo GX/Cerbo GX) can be used to automatically start and stop a generator. This relay - or switch - can be 'tripped' by a number of user-defined conditions. This manual will explain what conditions are available to you; and it will guide you through the steps required to set-up this useful functionality.

This is one of the available options to automatically start and stop a generator. See the [GX - Generator auto start/stop \[81\]](#) for an overview of all options. More general information about using a generator in combination with Victron is available [here](#).

### 16.2. Wiring

Firstly, wire the relay to a genset. The relay is located on the back of the Cerbo GX - marked Relay. If using a Cerbo GX, two relays will be seen at the bottom of the unit - only Relay 1 can be used for the generator automatic start/stop functionality.

Wiring between the Cerbo GX/Cerbo GX needs to be 'permanent' in order for the generator to keep running; and also to allow automatic 'Stop' when the parameters for auto-stop have been met.

Besides driving the internal relay, the auto start/stop functionality can be also enabled to directly control supported Fischer Panda generators. For more information on how to connect Fischer Panda generators, see [Cerbo GX & Fischer Panda generators](#).

There are many variations on the generator side for wiring and you should also consult your generator manual or supplier regarding their remote wire start configuration.

### 16.3. Enabling the start/stop function

Go to: Settings → Relay and set the Function options to “Generator start/stop”

#### Relay



Now that has been enabled, all the settings pertaining to the Automatic Generator Start/Stop function will be found in the main Menu under: Settings → Generator start and stop.

#### Fischer Panda Generators

1. Enable the “AutoStart” function in the Fischer Panda generator control panel.
2. Go to the Fischer Panda genset page and set the Mode setting to “Auto start/stop”

Once the Mode is set, all settings will become available under the Auto start/stop menu entry at the bottom of the page.



## 16.4. General start/stop - Main Page

From the Main Menu select Settings > Generator start/stop:



- **Generator state:** Current status of the generator.
- **Error:** Error description.
- **Runtime:** Generator run-time since last start.
- **Total run time:** Accumulated running time since the first start.
- **Time to next test run:** When the 'test run' option is enabled this item shows the time remaining until the next test run.
- **Daily runtime:** Running time history for the last 30 days.
- **Settings:** This is the gateway to all other features.

## 16.5. Settings

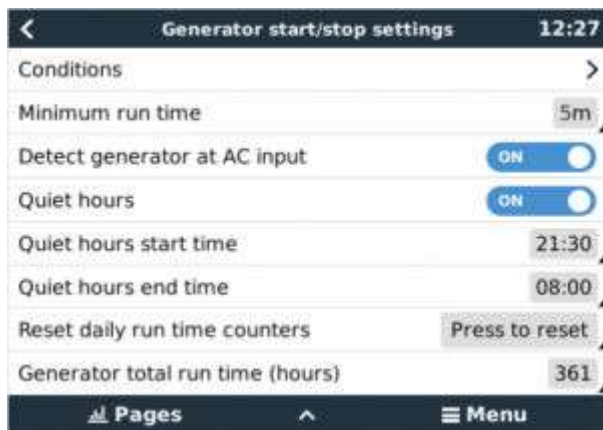

Conditions: See [Conditions](#)

**Minimum run time:** It's good practice for a generator, once started, to be allowed to reach its operating temperature. When started manually this setting is ignored.

**Detect generator at AC input:** Enabling this feature will raise an alarm on the GX device, as well as trigger an alarm email from the VRM portal(1), whenever power is not detected at the AC input terminal of the Inverter/Charger. This function will bring attention to a wide variety of problems; such as lack of fuel, or a mechanical or electrical fault at the generator. This functionality is not available for VE.Can connected Multi/Quattro. (1) requires automatic alarm monitoring on VRM to be enabled. Which it is by default.

**Quiet hours:** See [Quiet hours](#)

**Reset daily run time counters:** Resets the 30 day run-time history.

**Generator total run time:** Reset, or modify, the total run-time hours.

## 16.6. Conditions: User-definable parameters which trigger a generator auto-start.

To get to Conditions from the main menu go to: Settings → Generator start and stop → Settings → Conditions

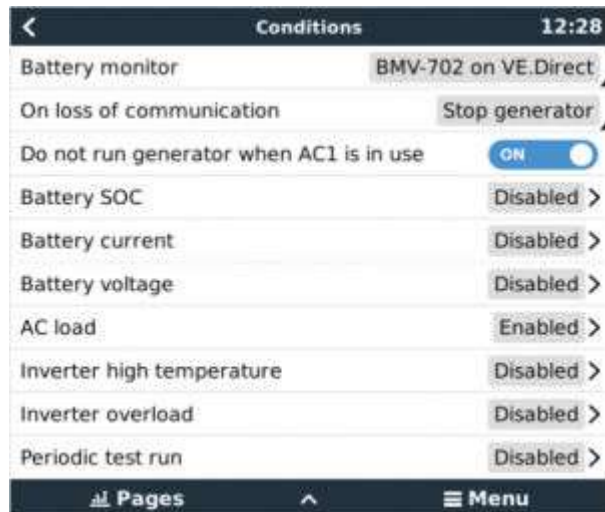

\* **Battery monitor:** Select how the battery will be monitored - if at all. The battery monitor data will be used for DC-related conditions.

\* **On loss of communication:** If ever there is a communication breakdown between the Cerbo GX/Cerbo GX and the selected battery monitor, and/or VE. Bus inverter/charger; and parameters have been set which depend on this information - choose between the following actions:

- **Stop the generator:** If the generator is running, it will be stopped. (default)
- **Start the generator:** If the generator is not running, it will be started.
- **Keep running:** If the generator is running at the time of data loss this setting will keep it running.

\* **Do not run genset when AC 1 is in use:** This option is ideal for back-up systems where a Quattro has mains/grid electricity connected to its AC-in 1 terminal, and a Genset connected to its AC-in 2 terminal. With this option enabled, the Genset will only start after a mains failure. And where a mains failure has occurred, the Genset will automatically be stopped again as soon as mains power is restored. This functionality is not available for VE.Can connected Quattros.

**The following parameters may be user-defined to trigger an automatic Generator start/stop:**

- Manual
- State of charge (SOC)
- AC load\*
- Battery current
- Battery voltage
- Inverter high temperature
- Inverter overload
- Periodic test run

(\* The value measured here will be the total AC consumption of the system.)

Condition-parameters are prioritized in the order shown above. When a number of conditions are reached at the same time, only the highest-priority condition will be shown as active. All enabled conditions will be evaluated - even if the generator is already running. When the active condition has been satisfied, an un-met parameter in a lower-priority condition will keep the generator running.

### Relays triggered by Battery SOC

- **Use Battery SOC value to start/stop:** Toggle this feature on or off.
- **Start when Battery SOC is lower than:** Set the depletion level for auto-start.
- **Start value during quiet hours:** During [Quiet hours](#) it may be desirable to delay an auto-start until it really can't be avoided. If [Quiet hours](#) has been defined, set a lower, more critical, autostart level.



- **Stop when Battery SOC is higher than:** Set the recharge level for auto-stop.
- **Stop value during quiet hours:** If [Quiet hours](#) has been defined, set a lower auto-stop level to achieve a shorter generator run-time.

#### Relays triggered by Battery Current

- **Use battery voltage value to start/stop:** Toggle the feature on or off.
- **Start when battery voltage is lower than:** When a high AC demand is experienced which will soon exhaust the battery, the generator can be auto-started to assist in meeting that demand. Set the current-level at which this will occur.
- **Start value during quiet hours:** If [Quiet hours](#) has been defined set a higher, more critical current value
- **Start after condition is reached for:** Set a delay before auto-start. Some AC device will draw a short-term, high-peak current on start-up. Instigating a delay before auto-start will avoid starting the generator unnecessarily.
- **Stop when battery current is lower than:** Set the current for auto-stop.
- **Stop value during quiet hours:** If [Quiet hours](#) has been defined, set a higher current level to achieve shorter generator run-times.
- **Stop after the condition is reached for:** Set a delay to ensure that the current-reduction condition is stable.

#### Relays triggered by Battery Voltage

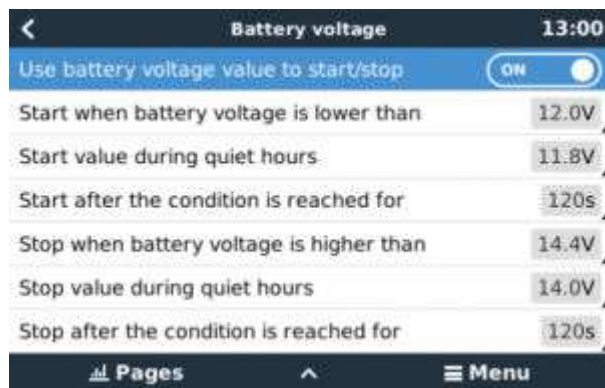

- **Use battery voltage value to start/stop:** Toggle the feature on or off.
- **Start when battery voltage is lower than:** When battery voltage falls below the value entered the relay will start the generator.
- **Start value during quiet hours:** If [Quiet hours](#) has been defined enter a lower (more critical) value to ensure the generator will only auto-start when absolutely necessary.
- **Stop after the condition is reached for:** This feature builds in a delay before stopping the generator after the 'stop' value has been reached. This is to make sure that the voltage rise is stable.

#### Relays triggered by AC load

AC load triggers work similarly to other triggers but the feature is refined by a Measurement setting.

The Measurement setting is available on firmware v2.0 and later and has three possible values:

##### Total consumption (Default option)

##### Inverter total AC out

##### Inverter AC out highest phase

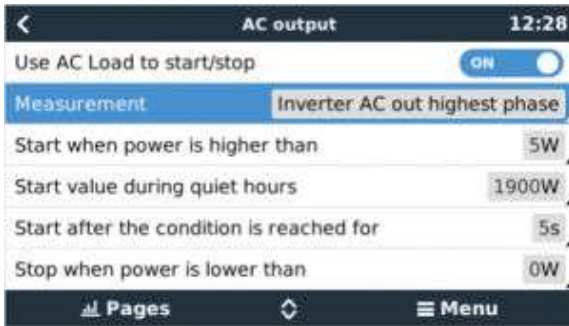

#### Relays triggered by Inverter High temperature

- **Start on high temperature warning:** Toggle this feature on or off.
- **Start when warning is active for:** Set a delay to avoid temperature rises which are temporary, caused by brief high AC demands.
- **When warning is cleared stop after:** Set a delay to ensure that a reduction in inverter temperature - usually caused by lower power demand - is stable.

#### Relays triggered by Inverter overload

- **Start on overload warning:** Toggle this feature on or off.
- **Start when warning is active for:** Set a delay to ensure that the inverter overload warning has not been triggered by a high-demand of AC power of only short duration.
- **When warning is cleared stop after:** Set a delay to ensure that the reduction in AC power demand is stable.

#### Automatic periodic 'Test run'

This feature allows automatic generator starts, periodically, as a 'test run'.



- **Test run interval:** Set the interval between test runs.
- **Skip test run if has been running for:** The test will be skipped if during the test run interval the generator ran for at least as long as it would on a 'test run'.
- **Test interval start date:** The 'test run' interval counter will start from the date entered here. No test runs will be carried out until the date set here has been reached.
- **Start time:** Time of day at which the generator 'test run' will commence.
- **Test duration:** Duration of the test.
- **Run until battery is fully charged:** Enabling this feature will cause the 'test run' to continue until the battery is fully charged - instead of for a fixed amount of time.

#### Manual-Start Feature

Use the Manual start feature to remotely start the generator. You can also press Start when the generator is already running - doing so will ensure that the generator won't automatically stop when the condition which caused it to start has been satisfied. In other words, the Manual start feature will override the auto-stop parameters.

There are two ways to start the generator manually:

**Using the Manual start menu:** Go to: Generator start and stop → Manual start; and then toggle the graphic to start the generator.

**Using the GX 'Home page' Generator graphic:** Press the top-left button on the Cerbo GX, or Cerbo GX remote console and engage the Generator page. Then press the center button. You must first choose how you wish to stop the generator - manually, or by entering a run-time. Once you've made your selection a five-second countdown will begin during which you can abort the manual-start by pressing the center button.

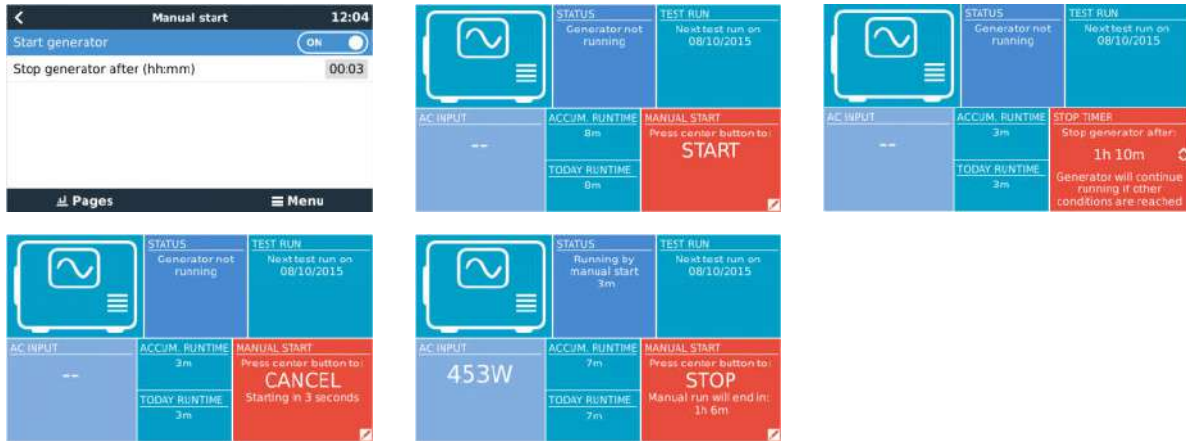

**WARNING:** If the generator is started manually (remotely) without using the stop timer, it will run until the 'Off' button has also been manually toggled.

The stop timer is available to both methods of manually remote-starting the generator, and using it will ensure that the generator will auto-stop ...and will not be inadvertently forgotten.

Note that stopping the generator manually can only be achieved when no un-met 'run' condition is active. If you wish to force a generator-stop you must first disable the function which is keeping it running - or disable the Generator start and stop function.

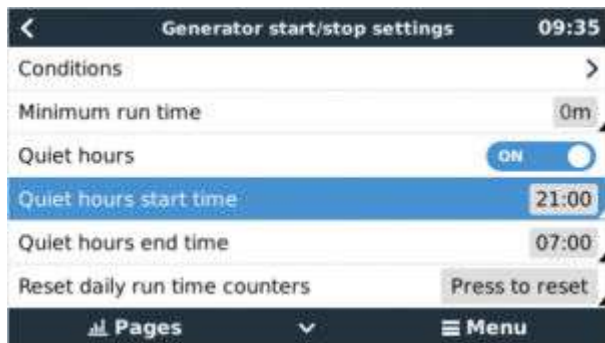

**Quiet hours**

*Quiet hours* allows you to define a period during which the noise from a running generator would be a nuisance; and to set different values to the conditions which would cause an auto-start during this period - thus ensuring that the generator will only start during a quiet period when it is absolutely necessary.

From the main menu go to: Settings → Generator start/stop → Settings; and then toggle-on the *Quiet hours* feature. Define the *Quiet hours* start- and end- times in the boxes which appear below.

*Quiet hours* will become the permanent condition (when enabled) if the defined 'start' and 'stop' times are the same.

**Using "Quiet hours" as a tool to define two sets of user-preferences**

Alternatively, the "Quiet hours" feature can be used to define how you wish your system to respond to different circumstances - for example:

- **Early morning/low SOC:** Battery SOC is often lowest in the morning. Couple this with cloudy weather first thing - or panels which have a westerly bias, and which tend to do better in the afternoon; and you have a circumstance where the generator may auto-start in the morning triggered by a low battery SOC condition - yet later on when the day brightens the solar energy is wasted because the work has already been done by the generator. Setting the *Quiet hours* feature to cover this period, together with lower auto-start conditions, will help to avoid unnecessary generator auto-starts.
- **Holiday home:** Holiday homes which are only inhabited part-time experience much deeper power-draws when they are in use. The *Quiet hours* feature can be used to set much lower auto-start parameters when the house is in use, than when it is empty. *Quiet hours* should be set to be the permanent condition (See above) during occupation; and the *Quiet hours* feature can be toggled 'off' whenever the house is empty.

## 16.7. Troubleshooting

### **Fischer Panda: Generator does not start and "Remote switch control disabled" error is show**

Enable the "AutoStart" function in the Fischer Panda control panel.

### **Fischer Panda: Auto start/stop function has stopped working after an error**

Make sure that the issue is solved, then clear the error, and the auto start/stop function will work again.

## 17. Reset to factory defaults procedure

A GX device factory reset is performed by inserting a USB stick or SD card with the specific reset file on it.

Factory reset requires Venus firmware version 2.12 or higher. It does not require any buttons or a screen to perform.

How to reset a GX device to factory default settings:

1. download the [venus-data.tgz](#) file
2. copy the [venus-data.tgz](#) file onto a blank, freshly formatted FAT32 usb-drive/sdcard (don't unpack or unzip that file, don't rename it).
3. boot with the usb-drive/sdcard inserted and wait until the GX Device has fully started up.
4. remove the usb-drive/sdcard from the GX device
5. power cycle the device, or as an alternative and when available, use the Reboot function in the Settings -> General menu.

This will reset the settings on the GX device to their factory defaults.

There are several technical reasons to do this, such as:

- if the device has been locked out by setting and then forgetting the Remote Console password on a model which doesn't have a screen.
- customer has no issue but wants to have a clean start.
- a GX device has been used in a testing environment, and the service technician wants to remove the residual memory of that (such as discovered AC PV inverters)
- GX device is performing strangely, and a reset to default may eliminate the possibility of a misconfigured setting.
- data partition is full, this should only occur when someone has modified their device.
- some unexpected bug, most likely only occurring in beta testing versions.



Previously saved Wifi access credentials will be reset - for devices without a physical interface and using wifi to connect, consider how you will get access again to reconfigure.

You may also need to reset the VRM authorisation token after performing a factory reset. After the reset, open the site in VRM - if a token reset is required, there will be a notification in VRM and you can follow the instructions provided in there.

The factory reset does NOT modify the VRM site ID, or data that is stored on the VRM. If you wish to sell your GX device to someone else, or install it into another system and want to clear the history, you can do this in the VRM Portal by selecting the Site settings -> General -> Delete this installation.

## 18. Error Codes

### Different origins of errors

On your GX device, some error codes shown will be from the GX device itself, in that case see below list. As the system control panel, it also shows error codes from the connected devices.

- Multi and Quattro inverter/chargers: [VE.Bus Error Codes](#)
- MPPT Solar Chargers: [MPPT Solar Charger Error Codes](#)

### GX Error #42 - Storage corrupt

This error means that the flash memory inside the GX Device is corrupt.

The device must be sent in for repair/replacement. It is not possible to correct this issue in the field or with a firmware update.

The affected flash memory is the partition that holds all user settings and factory data, such as serial numbers and wifi codes.

### GX Error #47 - Data partition issue

The internal storage in the GX Device is most likely broken: causing it to lose its configuration.

Contact your dealer or installer; see [www.victronenergy.com/support](http://www.victronenergy.com/support)

### GX Error #48 - DVCC with incompatible firmware

This error is raised when the DVCC feature is enabled whilst not all devices in the system are updated to recent enough firmware. More information about DVCC and minimal required firmware versions in chapter 4 of this manual.

#### Note for systems with BYD, MG Energy Systems, and Victron Lynx Ion BMS batteries:

Since Venus OS v2.40, released in December 2019, the DVCC feature is automatically switched on when the system detects a supported battery/BMS type connected. In systems that require DVCC to be enabled by the battery manufacturers, it is now no longer possible to switch DVCC off.

This creates an issue for systems installed and commissioned a long time ago, before DVCC was available, and they may not have the other necessary components or firmware to work correctly with it enabled.

The solution is to:

1. Disable automatic updates; Settings → Firmware → Online updates.
2. Roll back to v2.33; See Settings, Firmware and then Stored backup firmware.
3. Make sure that DVCC is disabled again.

Please do consult your installer, to check if the battery system is managed with two wire control (an earlier alternative control method to DVCC) or not:

If there is no charge- and discharge- wiring between BMS, inverter/chargers and charge controllers, then DVCC is required for above mentioned battery brands, and this also has certain minimum firmware requirements for connected Inverter/chargers and Solar charge controllers.

What's new since Venus OS v2.40 is (a) that it automatically enables DVCC when it sees the above mentioned battery types, and (b) that when DVCC is enabled, it checks the connected devices for the minimum firmware, and raises Error #48 in case the firmware of one or more connected devices is too old.

### GX Error #49 - Grid meter not found

This warning is raised in an ESS system when Grid metering is configured to use an External meter, but no meter is present. This alerts installers and end-users that the system is not correctly configured, or cannot operate correctly because it cannot communicate with the grid meter.

## 19. More information

- [GX - Generator auto start/stop](#)
- [GX - Using Fischer Panda Generators](#)
- [GX - GSM cellular modem](#)
- [VRM Portal - Remote VEConfigure and remote firmware updates](#)
- [VRM Portal - Documentation and troubleshooting](#)

## 20. FAQ

### 20.1. Q1: I cannot switch my Multi/Quattro system on or off

To solve the problem, first find out how the system is connected, and then follow the right step by step instruction below. There are two ways to connect a Multi/Quattro system to a Cerbo GX. In most systems they will be connected directly to the VE.Bus port on the back of the Cerbo GX. And, option two, in some systems they are connected to the Cerbo GX using a [VE.Bus to VE.Can interface](#).

#### Step by step instructions when connected to VE.Bus port on the Cerbo GX

1. Update the Cerbo GX to the latest available version. See our blog posts in the <https://www.victronenergy.com/blog/category/firmware-software/>.
2. Do you have a Digital Multi Control or VE.Bus BMS in the system? In that case it is normal that on/off is disabled. See also the VE.Bus related notes in the [Cerbo GX manual](#)
3. In case you have had a Digital Multi Control or VE.Bus BMS connected to your system, the Cerbo GX remembers it and even when those accessories have been removed the On/off switch will still be disabled. To clear the memory, execute a Redetect system, the option is in the Multi or Quattro section of the Cerbo GX menu.
4. For parallel/three phase systems consisting of more than 5 units: depending on temperature and other circumstances, it might not be possible to switch a system back on after switching it off with the Cerbo GX. As a work around you'll need to unplug the VE.Bus cable from the back of the Cerbo GX. And plug it back in after starting the VE.Bus system. The real resolution is to install the "Cerbo GX dongle for large VE.Bus systems", partnumber BPP900300100. For details, read its [connection instruction](#).

#### Step by step instructions when connected to Cerbo GX via VE.Can.

1. Update the Cerbo GX to the latest available version. See our blog posts in the firmware category.
2. Update the VE.Bus to VE.Can interface to the latest version. The easiest way to do that is by using Remote firmware update: having a special piece of hardware, the CANUSB, is then not necessary.
3. Do you have a Digital Multi Control or VE.Bus BMS in the system? In that case it is normal that on/off is disabled. See also the VE.Bus related notes in the Cerbo GX manual
4. In case you have had a Digital Multi Control or VE.Bus BMS connected to your system, and it is now no longer connected, the Canbus interface remembers it. Therefore, even after those accessories have been removed, the On/off switch will still be disabled. Clearing this memory is unfortunately not possible yourself, please contact us so we can help you.

### 20.2. Q2: Do I need a BMV to see proper battery state of charge?

Moved [here](#).

### 20.3. Q3: I have no internet, where can I insert a sim-card?

There is no 3G modem in the GX Device, and therefore also no slot for a sim-card. Go to a local store and buy a 3G router with Ethernet ports. More information in the blog post link below and particularly in the comments section, as more users try differing equipment:

<https://www.victronenergy.com/blog/2014/03/09/off-grid-color-control-gx-to-vmr-portal-connectivity/>

Note that it is not possible to use a VGR2 or VER for this. Also it will not be possible in the foreseeable future.

### 20.4. Q4: Can I connect both a GX Device and a VGR2/VER to a Multi/Inverter/Quattro?

No. Also, instead of this combination, we recommend to use the Cerbo GX, and add a 3G or similar mobile router. See [Internet connectivity \[18\]](#).

### 20.5. Q5: Can I connect multiple Cerbo GX to a Multi/Inverter/Quattro?

No.



## 20.6. Q6: I see incorrect current (amps) or power readings on my Cerbo GX

Examples are:

- I know that a load is drawing 40W from the Multi, but the Cerbo GX shows 10W or even 0W.
- I see that the Multi is supplying a load with 2000W, while in inverter mode, but from the battery only 1850W is being taken. Is those 150W coming out of nowhere?

The general answer is: the Multi and Quattros are not measurement instruments, they are inverter/chargers, and the measurements shown are a best effort delivery.

In more detail, there are several causes for measurement inaccuracies:

1. Part of the power taken from a battery by the inverter is being lost in the inverter, converted into heat: efficiency losses.
2. The Multi does not really measure the power being drawn from the battery. It measures the current at the output of the inverter, and then makes an assumption of the power being drawn from the battery.
3. Watts vs VA: depending on the Multi/Quattro firmware version and also the Cerbo GX firmware version, you are either looking at VAs (the result of calculating AC voltage \* AC current) or looking at a Watts measurement. To see WATTS on the Cerbo GX, update your Cerbo GX to the latest version (v1.21 or newer). Also make sure the firmware version in your Multi supports Watts readout, minimum versions are xxxx154, xxxx205 and xxxx300.
4. Multis/Quattros connected to the Cerbo GX via a VE.Bus to VE.Can interface will always reports VAs, not (yet) Watts.
5. If a current sensor assistant is loaded in a Multi/Quattro and no sensor is connected it will return invalid power / kWh values.
6. If a current sensor assistant is loaded in a Multi/Quattro make sure the position is set correctly and the scale match with the dipo switches on the sensor itself.
7. A current sensor assistant measures and reports VAs, not Watts.

Notes for systems with multiple units in parallel:

1. Cerbo GX version prior to v1.20 use the power and current reported by the master of a phase and multiplied that by the number of devices in that phase. Since version v1.20 the values of all device is summed per phase and hence should be more accurate.
2. This revealed a bug for in the firmware of the multi when running in parallel. Ccgx v1.21 workarounds this, by falling back to the original behavior when it sees an affected firmware version. For better readings the multi's should be updated. The bug has been fixed in VE.Bus firmware version xxxx159, xxxx209, xxxx306. That firmware was released on February 17th 2015.
3. Multi firmware versions since 26xx207 / xxxx300 can also freeze the Power values at a certain moment in time.

Tips to prevent measurement problems:

1. Do not connect VEConfigure while the Cerbo GX is connected
2. VE.Bus is not a 100% plug and play system: if you disconnect the Cerbo GX from one Multi, and very quickly connect it to another, it can result it wrong values. To make sure that this is not the case, use the 'redetect system' option in the Multi/Quattro menu on the Cerbo GX.

## 20.7. Q7: There is a menu entry named "Multi" instead of the VE.Bus product name

A VE.Bus system can be completely turned off, including its communication. If you turn a VE.Bus system off, and thereafter reset the Cerbo GX, the Cerbo GX cannot obtain the detailed product name and shows "Multi" instead.

To get the proper name again, go into the Multi menu on the Cerbo GX and set the Switch menu entry to On or in case a Digital Multi Control is present, set the physical switch to On. Note that when there is a BMS, above procedure only works when within battery working voltages.

## 20.8. Q8: There is a menu entry named "Multi", while there is no Inverter, Multi or Quattro connected

If a Cerbo GX ever saw a VE.Bus BMS or Digital Multi Control (DMC), it will remember them, until 'Redetect system' is started from the Cerbo GX menu. After a minute, restart the Cerbo GX: Settings → General → Reboot.

## 20.9. Q9: When I type the ip-address of the Cerbo GX into my browser, I see a web page mentioning Hiawatha?

Our plan is to at least run a website where you can change settings and see the current status. If all works out as we would like to, there might come be a fully functional version of the online VRM Portal running locally on the Cerbo GX. This allows people without an internet connection, or an intermittent internet connection to have the same features and functionality.

## 20.10. Q10: I have multiple Solar chargers MPPT 150/70 running in parallel. From which one will I see the relay status in the Cerbo GX menu?

From a random one.

## 20.11. Q11: How long should an automatic update take?

The size of the download typically is around 90MB. After download it will install the files which can take up to 5 minutes.

## 20.12. Q12: I have a VGR with IO Extender, how can I replace this with a Cerbo GX?

It is not yet possible to replace the IO Extender functionality.

## 20.13. Q13: Can I use Remote VEConfigure, as I was doing with the VGR2?

Yes, see [VE Power Setup manual](#)

## 20.14. Q14: The Blue Power Panel could be powered through the VE.Net network, can I also do that with a Cerbo GX?

No, a Cerbo GX always needs to be powered itself.

## 20.15. Q15: What type of networking is used by the Cerbo GX (TCP and UDP ports)?

Basics:

- The Cerbo GX needs to have a valid IP address including a working DNS server and gateway. By default obtained from a DHCP server. Manual configuration is also possible.
- DNS port 53 UDP and TCP
- NTP (time sync) UDP port 123. NTP uses a pool of servers provided by [ntp.org](http://ntp.org), so this will connect to a wide variety of servers.

VRM Portal:

- Data is transmitted to the VRM Portal via HTTPS POST and GET requests to <http://ccgxlogging.victronenergy.com> on port 443. There is an option in the menu to use HTTP instead, port 80. Note that in that case it will still send sensitive data such as remote Console related access keys over HTTPS/443.

Firmware updates:

- The Cerbo GX connects to <https://updates.victronenergy.com/> on port 443.

Remote support and Remote Console on VRM:

- An outbound reverse SSH connection is made to [supporthosts.victronenergy.com](http://supporthosts.victronenergy.com) when either one, or both, of those features are enabled. The [supporthosts.victronenergy.com](http://supporthosts.victronenergy.com) record resolves to multiple IP addresses, and the DNS uses Geo-Location to resolve it to the nearest server. This outbound SSH connection tries multiple ports: port 22, port 80 or port 443. The first that works is used, and in case it loses connection it will retry them all again.
- No port forwarding or other internet router configuration is necessary to use these features.
- More information about the Remote Support feature is in the next FAQ item.
- More information about troubleshooting Remote Console on VRM is in here: [Remote Console on VRM - Troubleshooting \[59\]](#).

Two way communication (Remote VEConfig and Remote Firmware updates):

- Pre-v2.20: Uses HTTPS (port 443) to the Pubnub servers

- v2.20 and later: connects to mqtt-rpc.victronenergy.com on port 443; and also connects to the mqtt{1 to 128}.victronenergy.com server farm. See this document for more information.

MQTT on LAN:

- When enabled, a local MQTT broker is started, which accepts TCP connections on port 8883 (SSL) and 1883 (Plain text).
- Depending on, the Cerbo GX will also (try to) connect to the Victron MQTT cloud servers. This connection always uses SSL and port 8883.

Remote Console on LAN:

- Remote Console on LAN requires port 80 (small website hosted the GX Device). And also requires port 81, which is the listening port for the websocket tunnel to VNC.

Modbus TCP:

- When enabled, the ModbusTCP server listens on the common designated port for Modbus TCP, which is 502.

SSH Root Access

- Port 22 - see the Venus OS root access documentation.
- This is a software developers feature.

## 20.16. Q16: What is the functionality behind the menu item Remote support (SSH), in the Ethernet menu?

When enabled, the Cerbo GX will open a SSH connection to our secure server, with a reverse tunnel back to the Cerbo GX. Through this tunnel, Victron engineers can login to your Cerbo GX and perform remote support. This works when the Cerbo GX is installed on an internet connection. The connection will even work when installed behind a firewall.

The SSH connection will be outbound, to port 80, 22 or 443 to supporthosts.victronenergy.com, which resolves to multiple IP addresses and depends on your location. Remote support functionality is disabled by default.

## 20.17. Q17: I don't see support for VE.Net products in the list, is that still coming?

No.

## 20.18. Q18: What is the data usage of the Cerbo GX?

Data usage depends heavily on amount of connected products, and behavior and usage of those products. The measurements below are an indication only, and taken from a system with one Cerbo GX, one Multi, one BMV and one MPPT. Log interval set to 15 minutes. If you are on an expensive data-plan, do make some fail-safe.

Data consumption per month:

- VRM logging: 15MB download, 45MB upload
- Remote support: 22MB download, 40MB upload
- Update checks: 8MB download, 0.3MB upload (This does not include the update itself)
- 2 way communication: 26MB download, 48MB upload

Mentioned megabytes do not include the download of a Cerbo GX firmware update. Firmware updates of 60MB are not uncommon.

## 20.19. Q19: How many AC Current Sensors can I connect in one VE.Bus system?

The current maximum is 9 sensors (since Cerbo GX v1.31). Note that each need to be configured separately with an assistant in the Multi or Quattro to which it is wired.

## 20.20. Q20: Issues with Multi not starting when Cerbo GX is connected / Caution when powering the Cerbo GX from the AC-out terminal of a VE.Bus Inverter, Multi or Quattro

Make sure that the GX device and MultiPlus is running the latest firmware version.

If you power the Cerbo GX from an AC adaptor connected to the AC-out port of any VE.Bus product (Inverter, Multi or Quattro), then a deadlock can occur after the VE.Bus products are powered-down for any reason (after any operational fault or during a black start). The VE.Bus devices will not boot-up until the Cerbo GX has power ...but the Cerbo GX will not boot-up until it has power. See FAQ for more information about this.

This deadlock can be rectified by briefly unplugging the Cerbo GX VE.Bus cable at which point you will observe the VE.Bus products will immediately begin to boot-up.

This deadlock can be avoided in two ways:

- Power the Cerbo GX from the battery; or
- Cut pin 7 in the VE.Bus cable connected to the Cerbo GX

Cutting/Removing pin 7 of the VE.Bus cable to the Cerbo GX (brown/white according to standard RJ45 ethernet cable colour coding) allows the VE.Bus products to start up without waiting for the Cerbo GX to boot up first.

Note that when using a Redflow ZBM2/ZCell battery, pin 7 should be cut even if the Cerbo GX is DC powered, to avoid the same deadlock at times when the Redflow battery cluster is at 0% SoC.

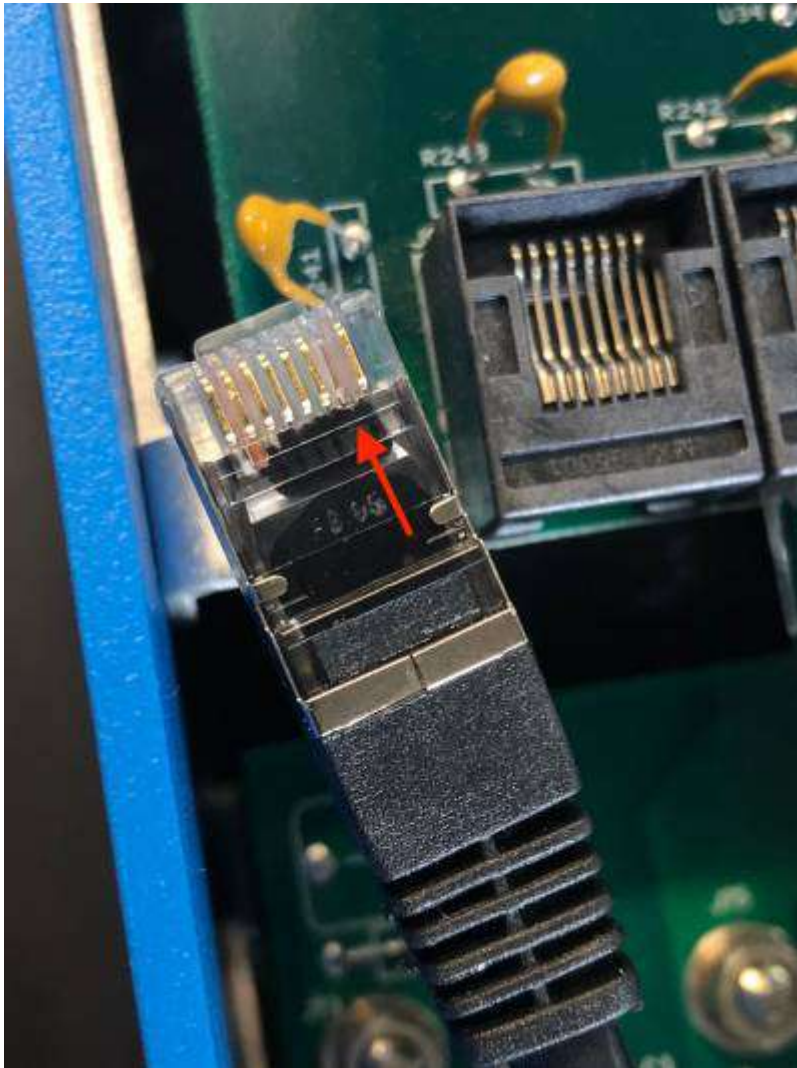

The disadvantage of cutting pin 7 is that switching the VE.Bus device off will be less effective: although it will stop charging and inverting, it will still be in standby mode and therefore drawing more current from the battery than if pin 7 had been left in place. Typically this is only relevant in Marine or Automotive systems where it's normal to regularly switch the VE.Bus device off. For those types of systems we recommend that you do not cut pin 7, but simply power the Cerbo GX from the battery.

## 20.21. Q21: I love Linux, programming, Victron and the Cerbo GX. Can I do more?

Yes you can! We intend to release almost all code as open source, but we are not that far yet. What we can offer today is that many parts of the software are in script or other non-compiled languages, such as Python and QML, and therefore available on your Cerbo GX and easy to change. Root password and more information is available [here](#).

## 20.22. Q22: How do I change the logo

Type the following address into the web browser of a device connected to the same network. Using this address as a template: [http://\[ip-here\]/logo.php](http://[ip-here]/logo.php) (inserting your device's IP address between the square brackets). The IP address can be found by going to Settings > Ethernet or Wifi. Once the page is loaded, Choose an image file from your device. Re-boot the GX device.

## 20.23. Q23: Multi restarts all the time (after every 10sec)

Please check the remote switch connection on the Multi control PCB. There should be a wire bridge between the left and middle terminal. The Cerbo GX switches a line which enables the power of the Multi control board. After 10 seconds this line is released and the Multi should take over from there. When the remote switch connection is not wired the Multi is unable to take over it's own supply. The Cerbo GX will retry, the Multi will boot and after 10 seconds stop, and so on.

## 20.24. Q24: What is Error #42?

If the GX Device shows an Error 42 - Hardware fault. In that case, the flash storage on the device is corrupt. As a result, settings will not be saved (rebooting resets back to default) and other problems will rise.

This error is not recoverable in the field or by repair departments. Contact your dealer for a replacement.

Firmware versions until v2.30 did not report the error. Since v2.30; its visible on the device itself (in the GUI) and on the VRM Portal.

## 20.25. Q25: My GX device reboots itself. What is causing this behavior?

There are several reasons why a GX device may reboot itself.

One of the most common causes is loss of communication with the VRM online portal.

However, this is only true if the "Reboot device when no contact" option (disabled by default) has been enabled in the VRM online portal settings. If there is no contact with the VRM portal for the time period set in 'No contact reset delay', the GX device will automatically reboot. This process is repeated until communication with the VRM portal is restored. See also [chapter 9.3. Datalogging to VRM - Network watchdog: auto-reboot](#).

- Check the network connection between your GX device and the router. See [chapter 9.4 Troubleshooting data logging](#).
- Preferably use an ethernet connection between your GX device and the router.
- Tethered or hotspot connections, e.g. with a cell phone, are not reliable and are often interrupted or do not automatically restore the connection once it has been lost. Therefore, this is not recommended.

Other common reasons that cause the GX device to automatically restart are:

- System overload (either CPU, memory, or both).

To reliably detect an overload of the system, there is the D-Bus round trip time (RTT) parameter, and this parameter is available on the VRM Portal. See image below how to set this up on VRM.

An RTT value between 1 and 100ms is fine, although 100ms is already quite high.

RTT peaks occurring now and then are not a problem. Permanently over 100ms is a problem and requires further investigation.

In case the cause is a system overload, then there are two solutions:

- Disconnect devices to reduce the load, with associated disadvantages.
- Or change the GX device for a more powerful one. In the current product offering - see our [Victron GX product range](#) -, the Cerbo GX & Cerbo-S GX is (far) more powerful than the CCGX as well as the Venus GX.



An occasional reboot is not causing any harm to system longevity or performance. The main effect is (temporary) disturbance of the monitoring.

### How to create a widget in the VRM portal to read out D-Bus round trip time:

1. Connect to the VRM Portal using a browser.
2. Click on the Advanced tab in the menu on the left side.
3. Click on the widget icon in the top right corner.
4. Scroll down to Custom Widget and click on it to create a new custom widget.
5. Give it a proper name, chose "Gateway" from the list in Select device and "D-Bus round trip time" in Select parameter.

6. After clicking on the Save button, the new widget will appear under the Advanced tab.

Tip: Keep the time period to be examined as small as possible to achieve a high resolution of the round trip time.

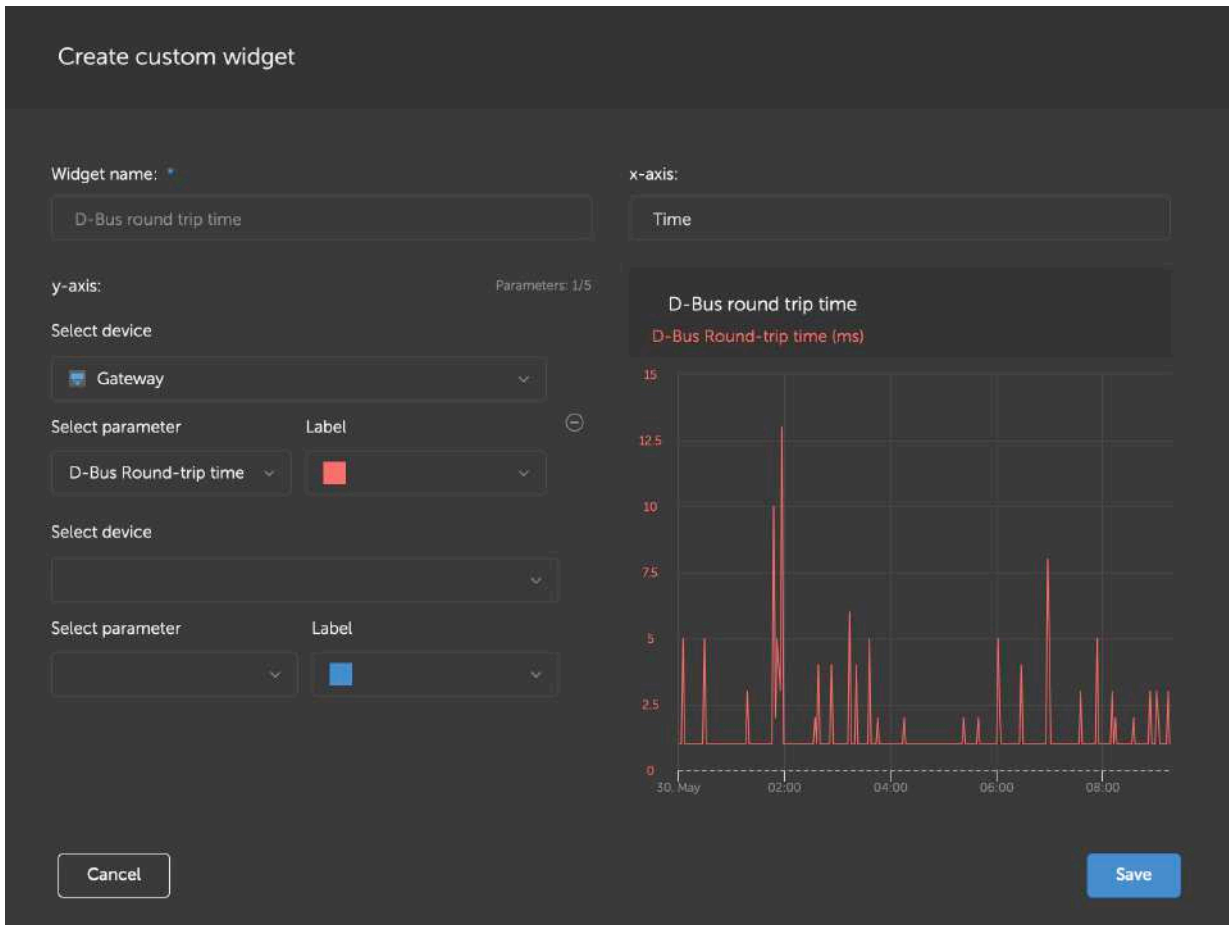

Custom widget that displays D-Bus round trip time for the GX device

## 20.26. GPL Note

The software included in this product contains copyrighted software that is licensed under the GPL. You may obtain the Corresponding Source code from us for a period of three years after our last shipment of this product.

## 21. Appendix

### 21.1. RV-C

#### 21.1.1. Supported DGNs

This chapter describes which data of the supported devices are available and the corresponding DGNs (Data Group Numbers).

RV-C defines several messages. A detailed specification of the protocol and message definition is publicly available on [RV-C.com](http://RV-C.com).

#### 21.1.2. RV-C out

##### Generic

All virtual devices support the following generic DGNs:

DGN	DGN#	Decimal	Description
PRODUCT_ID	0xFEEB	65259	Manufacturer, product name, serial number
SOFTWARE_ID	0XFEDA	65242	Software version
DM_RV	0x1FECA	130762	Diagnostics

##### VE.Bus Inverter/charger – *com.victronenergy.vebus*

Only VE.Bus MultiPlus/Quattro. Phoenix Inverter VE.Bus is also exported by this service, but then with number of AC inputs set to 0.

##### Status

DGN	DGN#	Decimal	Value
INVERTER_AC_STATUS_1	0x1FFD7	131031	L1 – instance 65: AC out voltage, current, frequency  L2 – instance 81: AC out voltage, current, frequency  <b>Note: Single-phase systems are supported. Split-phase systems (typical in US and CA) are supported. Three-phase systems are not supported; mainly because RV-C DGNs don't provide for the necessary fields.</b>
INVERTER_STATUS	0x1FFD4	131028	Instance 1: inverter status
CHARGER_AC_STATUS_1	0x1FFCA	131018	L1 – instance 1: AC input voltage, current, frequency  L2 – instance 17: AC input voltage, current, frequency  <b>Note: Single phase systems are supported. Split-phase systems (typical in US and CA) are supported. Three-phase systems are not supported; mainly because RV-C DGNs don't provide for the necessary fields.</b>
CHARGER_AC_STATUS_2	0x1FFC9	131017	Instance 1: input current limit
CHARGER_STATUS	0x1FFC7	131015	Instance 1: charger state
CHARGER_STATUS_2	0x1FEA3	130723	Instance 1: DC voltage, current
CHARGER_CONFIGURATION_STATUS_2	0x1FF96	130966	Instance 1: input current limit

**Commands**

DGN	DGN#	Decimal	Value
INVERTER_COMMAND	0x1FFD3	131027	Inverter enable/disable
CHARGER_COMMAND	0x1FFC5	131013	Charger enable/disable
CHARGER_CONFIGURATION_COMMAND_2	0x1FF95	130965	Charger input current limit

**Inverter – com.victronenergy.inverter**

Phoenix inverter VE.Direct and Inverter RS.

**Status**

DGN	DGN#	Decimal	Value
INVERTER_AC_STATUS_1	0x1FFD7	131031	L1 – instance 65: AC out voltage, current, frequency  L2 – instance 81: AC out voltage, current, frequency  <b>Note: Single phase systems are supported. Split-phase systems (typical in US and CA) are supported. Three-phase systems are not supported; mainly because RV-C DGNs don't provide for the necessary fields.</b>

**AC charger – com.victronenergy.charger**

Skylla-I, Skylla-IP44/IP65, Phoenix Smart IP43 Charger.

Note: Instance fixed to 2.

**Status**

DGN	DGN#	Decimal	Value
CHARGER_AC_STATUS_1	0x1FFCA	131018	AC current
CHARGER_AC_STATUS_2	0x1FFC9	131017	Input current limit
CHARGER_STATUS	0x1FFC7	131015	Charger state
CHARGER_STATUS_2	0x1FEA3	130723	DC instance 1: voltage, current output 1 DC instance 2: voltage, current output 2 DC instance 3: voltage, current output 3  <b>Note: DC instance 2, 3 are not sent if not present</b>
CHARGER_CONFIGURATION_STATUS_2	0x1FF96	130966	Input current limit

**Commands**

DGN	DGN#	Decimal	Value
CHARGER_COMMAND	0x1FFC5	131013	Charger enable/disable
CHARGER_CONFIGURATION_COMMAND_2	0x1FF95	130965	Charger input current limit

**Solar charger – com.victronenergy.solarcharger**

BlueSolar, SmartSolar, MPPT RS.

Note: Instance fixed to 1.

**Status**



DGN	DGN#	Decimal	Value
SOLAR_CONTROLLER_STATUS	0x1FEB3	130739	Operating state
SOLAR_CONTROLLER_STATUS_5	0x1FE82	130690	Total yield
SOLAR_CONTROLLER_BATTERY_STATUS	0x1FE80	130688	Battery voltage, current
SOLAR_CONTROLLER_ARRAY_STATUS	0x1FDFF	130559	PV voltage, current

**Battery/BMS – com.victronenergy.battery**

BMV, SmartShunt, Lynx Shunt, Lynx Ion, Lynx Smart BMS, BMS-Can batteries.

Note: Main (house battery): Instance 1, priority 119

Note: Starter: Instance 2, priority 20

**Status**

DGN	DGN#	Decimal	Value
DC_SOURCE_STATUS_1	0x1FFFD	131069	Voltage, current <b>Note: not sent for starter battery if not present</b>
DC_SOURCE_STATUS_2	0x1FFFC	131068	Temperature, soc, time remaining
DC_SOURCE_STATUS_4	0x1FEC9	130761	Desired maximum voltage, current

**Tanks – com.victronenergy.tank**

Tank level senders connected to the tank level input of a GX device, GX Tank 140, NMEA 2000 or VE.Can.

The tank instance is a combination of fluid type and occurrence, where first, second, third, etc. corresponds to 0-15, 16-31, 32-47, respectively. So 3 is the first LPG tank and 16 is the second Fuel tank. We only use the first instance, i.e. tank instances 0-15.

**Status**

DGN	DGN#	Decimal	Value
TANK_STATUS	0x1FFB7	130999	Fluid type, relative level, absolute level, tank size Resolution fixed to 100

RV-C supports only 4 tank types (0..3), while Victron supports up to 11 tank types. The table with the additional tank types is Victron specific and is compatible with the tank types we use.

**Supported tank types:**

Venus / NMEA 2000		RV-C
Fluid type	Fluid code	Type
Fuel	0	4 (Vendor defined)
Fresh water	1	0
Waste (Grey) water	2	2
Livewell	3	5 (Vendor defined)
Oil	4	6 (Vendor defined)
Black water	5	1
Gasoline	6	7 (Vendor defined)
Diesel	7	8 (Vendor defined)
LPG	8	3
LNG	9	9 (Vendor defined)
Hydraulic oil	10	10 (Vendor defined)
Raw water	11	11 (Vendor defined)

Note that Vendor defined means that these types are not defined in RV-C, but only used for Victron RV-C devices.

### 21.1.3. DGN 60928 Unique Identity Numbers

The GX device will assign an individual Unique Identity Number to each virtual device. Change it only when using multiple GX devices in one RV-C network.

The Unique Identity Number is used for the GX internal CAN-bus device "database" to compare devices during address determination. The Unique Identity Number can be changed in increments of 500, starting at 500. Example: The first GX device is automatically assigned the Unique Identity Number 1. For a second GX device, the unique identity number must be set to 501 (1 + 500).

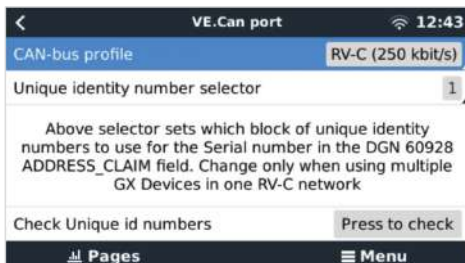

### 21.1.4. RV-C in

#### Tanks

For compatible devices see chapter Supported devices.

#### Batteries

For compatible devices see chapter Supported devices.

### 21.1.5. Device Classes

This section provides a basic overview of how each device class will participate in the RV-C specification. In any case, "Level 1" integration is largely supported (basic operation), with case-by-case enhancements.

#### AC standalone Chargers

- The AC-based charger class reports its operational status and configuration status using the CHARGER\_xx group of RV-C messages. User control must include basic on/off switching via RV-C as well as adjusting shore (AC) power limits.

#### AC standalone Inverters

- This class of AC inverters reports its operational status using the INVERTER\_xx group of RV-C reports. Incoming command is limited to on/off (enable/disable) via RV-C.

#### AC Charger / Inverter

- Combined inverter/charger - reports both CHARGER\_xx and INVERTER\_xx messages.

#### Solar Controllers

- Solar chargers will report their operational status in real time.

#### SOC Meters

- SOC meters can be used to report current battery health via RV-C: voltage, current, temperature, SOC, etc. RV-C requires that only ONE device speaks for a given battery at a time, so if a proper BMS is installed, that will be the data source.

#### BMS (Victron, or Victron 3rd party supported)

- In many cases, the battery(s) in the system will be directly attached to a Victron Cerbo GX or Cerbo-S GX, either via Victron equipment or via supported 3rd party compatible BMSs. Such batteries should be represented into the RV-C environment via the DC\_SOURCE\_STATUSxx messages.

#### Tank Level meters

- Tank meters will be translated into RV-C messages, carrying forward the existing tank ID/ VRM Instance numbers.

### 21.1.6. Instance Translation

RV-C utilises Instances in several ways:

- DC Source Instance
- AC Line
- Device Instance (context dependent)

Each usage of the Instance has a specific meaning, and a given device may at times utilise one or more of these instances.

#### DC Source Instance

In RV-C, a DC source is something that can generate and (optionally) store energy. Typically a battery but can also be a fuel cell or the output side of a DC contactor/disconnector.

A DC source can be thought of as a battery system and its associated physical bus, for example, the house battery, the DC bus bar and DC wiring. DC Source Instances are used to associate subsequent devices (e.g. a charger or an inverter) to the 'DC bus' it is connected to.

In this way it is possible to map out how all devices are connected with regards to their DC bus via their DC Source Instance value (starter battery and its alternator, house battery and its chargers etc.).

Note that in some cases (e. g. a DC-DC Converter or a Contactor), a device may be associated with two different DC Source instances. For example, a DC-DC converter could be associated with the two different batteries to which it is connected, while a contactor could be associated with the battery to which it is connected; the DC bus on the load side of the contactor then has its own DC Source instance

Though Victron is able to support more than one battery (a house and starter battery), the primary focus is on one battery. The dbus-rvc module will present the 'primary' battery to RV-C as 'DC Source Instance = 1' (house battery) information.

If present, additional Victron sensing devices will be presented using DC Source Instances of 2. An example is the optional starter battery voltage sensing on SmartShunts.

#### AC Line

AC line is much simpler, in that RV-C assumes a limited AC system, typically defined as Line 1 or Line 2. Victron supports 3-phase systems, which is not included in the RV-C specification. All installations with 3-phase systems are not supported by the dbus-RVC module and AC-related RV-C messages are suppressed.

#### Device Instance

Device Instance is a way to separate different physical devices of the same type. Example: if an installation contains two AC chargers attached to the same battery, each would be assigned a separate Device Instance while both would share the same DC Source Instance. Each charger would also be associated with an AC line, which may or may not be the same. In this way the AC charger is fully described in how it is wired on the AC and DC side while being able to be uniquely identified through its Device Instance.

Devices Instances are relevant within a given class of devices. An AC charger can define Device Instances 1 and 2, and these are unrelated to Device Instances 1 and 2 of a DC motor controller.



With the exception of tank monitoring, Device Instances are hard coded as 1 for each specific device class unless specified otherwise in the PGN table. Because the AC charger has a hardcoded instance of 2, to allow coexistence with an inverter/charger with charger instance 1.

### 21.1.7. RV-C Fault and Error Handling

#### RV-C fault reporting:

- Fault conditions are reported using the DM\_RV DGN (0x1FECA).
- In release 1 the operational status bits, the yellow and the red light field are supported because they are stored in DSA.
- SPN is set to 0xFFFFFFFF during normal conditions, and 0x0 at any time a warning or fault condition exists in supported Victron equipment.
- FMI is set of 0x1F (Failure mode not available) at all times.

This simple mapping allows external user displays to indicate an alarm or fault condition in a given Victron device, at which time the user should utilise Victron diagnostic aids for additional insight.

### 21.1.8. RV-C Device Priority

A critical concept in RV-C is the application of *Device Priorities*.

When used, a given device's priority will impact if it is allowed to transmit DGNs (e.g. a BMS with a higher priority should transmit details of the battery's status, while a MPPT controller with a lower priority should back down).

*Device Priority* is also at times used to allow for the favouring of one node vs. another, for example, it may be more desirable to use shore power AC vs. the inverter.

In the implementation of dbus-rvc, the following priorities will be hard coded into transmitted messages:

- DC\_SOURCE\_STATUS\_xx messages: Priority = 119 (SOC/BMS) to allow native RV-C batteries have a higher priority.
- SOLAR\_xx messages: Charger Priority = 110
- CHARGER\_xx messages (Inverter/Chargers):: Charger Priority = 100
- CHARGER\_xx messages (AC Chargers):: Charger Priority = 80