

JUST CONNECT

Compatible with **BERNER - BOSCH - BOSCH GREEN - DEWALT - EINHELL - FEIN - FESTOOL
FLEX - HAZET - HIKOKI - INGERSOLL - MAKITA - METABO - MILWAUKEE - RIDGID - SNAP-ON - WÜRTH**



ONE LIGHTING SOLUTION
FOR ALL BATTERY PACKS



One lighting solution for all battery packs

JUST CONNECT

Compatible with BERNER - BOSCH - BOSCH GREEN - DEWALT - EINHELL - FEIN - FESTOOL

FLEX - HAZET - HIKOKI - INGERSOLL - MAKITA - METABO - MILWAUKEE - RIDGID - SNAP-ON - WÜRTH



With the new SCANGRIP CONNECT series, we have created a range of hybrid and innovative work lights compatible across all leading power tool brands - an outstanding lighting solution never seen before!

We connect the world of power tool batteries and professional work lights providing complete freedom to use a SCANGRIP work light regardless of your battery brand preference.

SCANGRIP CONNECT product range



The CONNECT concept

04



NOVA CONNECT series

08



VEGA CONNECT series

12



AREA CONNECT series

14



TOWER 5 CONNECT

18



STANDS and
SUSPENSIONS

20



Technical specifications

22

3
years
warranty

PATENT PROTECTED

Designed by us. Manufactured by us.

One lighting solution for all battery packs

// SCANGRIP is proud to present a complete range of outstanding and one-of-a-kind work lights compatible with all 18V battery packs from leading power tool brands worldwide.

- Work lights compatible with 18V battery packs from all leading power tool brands
- Smart connector with BATTERY SAFETY SYSTEM
- Extremely powerful illumination and high durability

JUST CONNECT

One lighting solution for all 18V battery packs with the SCANGRIP CONNECTOR



With the unique SCANGRIP CONNECT concept, you have complete freedom to choose the SCANGRIP work light that fits your needs regardless of brand preference.

A new invented smart CONNECTOR is designed for each power tool brand. Simply mount the CONNECTOR to the work light, attach your battery and you are ready to work. A BATTERY SAFETY SYSTEM protects the battery pack and makes it safe to use.

The SCANGRIP CONNECT range consists of 8 work lights with the latest COB LED technology, extremely flexible design and high durability designed for the demanding professional user. A ground-breaking lighting solution never seen before!

**BERNER - BOSCH - BOSCH GREEN - DEWALT - EINHELL - FEIN - FESTOOL - FLEX - HAZET
HIKOKI - INGERSOLL - MAKITA - METABO - MILWAUKEE- RIDGID - SNAP-ON - WÜRTH**

// Maximal freedom

The SCANGRIP CONNECT range is compatible with the METABO/CAS battery system and all other 18V battery packs from leading power tools brands. As something unique, we also offer a POWER SUPPLY which can be used for direct power providing unlimited availability to light. With stands and suspensions available, the work lights can be placed anywhere you need efficient lighting offering complete flexibility at the worksite.

Use your 18V battery pack
for SCANGRIP CONNECT work lights



Convert your
SCANGRIP CONNECT
lamp to a corded model with the
POWER SUPPLY



An integrated battery backup
function prevents you from being
without light at any time

(Applies to NOVA 4 CONNECT, NOVA 10 CONNECT and AREA 10 CONNECT)

CAS Compatible with **METABO / CAS** battery system
For METABO / CAS no connector is required

SMART CONNECTOR

// SCANGRIP has developed a unique CONNECTOR for each individual power tool brand that fits 18V battery packs. Simply mount the CONNECTOR to the work light, attach your battery and you are ready to work.

BATTERY SAFETY SYSTEM

- Automatic discharge protection
- Overload protection
- Temperature surveillance
- Approved by TÜV Rheinland



The BATTERY SAFETY SYSTEM protects the battery pack and makes it safe to use. The safety system features an automatic discharge protection, overload protection and temperature surveillance which means you can use your 18V battery pack again and again without it being damaged.

The SCANGRIP CONNECTORS are approved by TÜV Rheinland. Each CONNECTOR is sold under separate item numbers and individually designed to fit each power tool brand.



Scan QR code to see TÜV Rheinland test report

JUST CONNECT

Add the connector matching your 18V battery pack

BERNER - BOSCH - BOSCH GREEN - DEWALT - EINHELL - FEIN - FESTOOL - FLEX - HAZET
HIKOKI - INGERSOLL - MAKITA - METABO - MILWAUKEE- RIDGID - SNAP-ON - WÜRTH

One lighting solution for all battery packs

JUST CONNECT

Compatible with BERNER - BOSCH - BOSCH GREEN - DEWALT - EINHELL - FEIN - FESTOOL
FLEX - HAZET - HIKOKI - INGERSOLL - MAKITA - METABO - MILWAUKEE - RIDGID - SNAP-ON - WÜRTH



NOVA 2 CONNECT - 2000 lumen handheld, compact floodlight

// Powerful compact and all-round work light designed for the professional user.

- Slim and compact design
- Extremely powerful illumination up to 2000 lumen
- Light dimmable in 5 steps
- Built-in powerbank

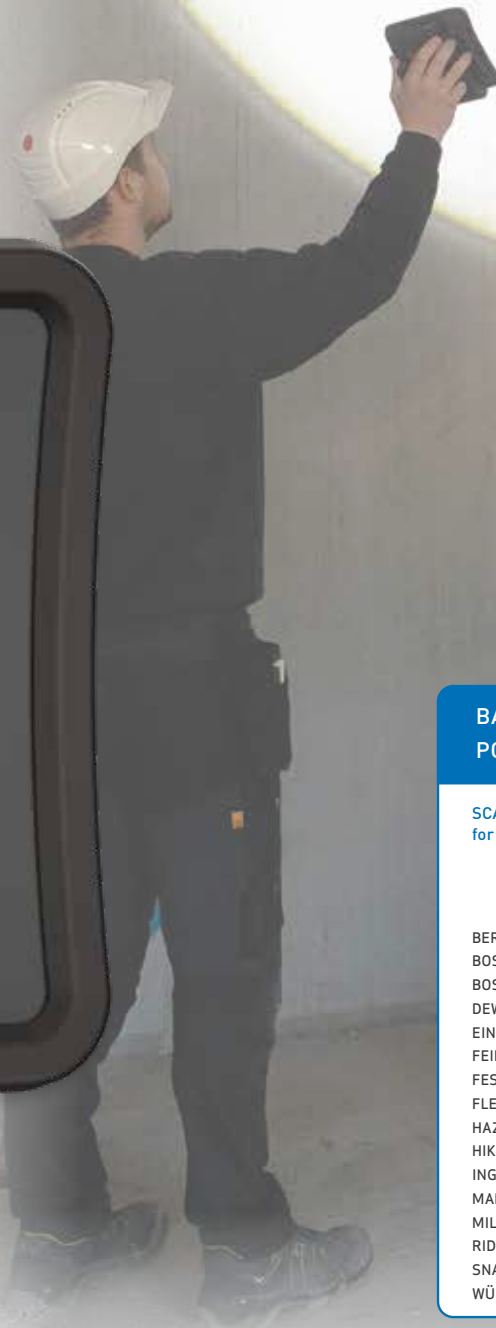

BATTERY, CHARGER, CONNECTORS AND POWER SUPPLY ARE SOLD SEPARATELY

SCANGRIP CONNECTORS for 18V battery packs



BERNER - 03.6155C
BOSCH - 03.6140C
BOSCH GREEN - 03.6141C
DEWALT - 03.6142C
EINHELL - 03.6143C
FEIN - 03.6144C
FESTOOL - 03.6153C
FLEX - 03.6145C
HAZET - 03.6146C
HIKOKI - 03.6147C
INGERSOLL - 03.6152C
MAKITA - 03.6148C
MILWAUKEE - 03.6149C
RIDGID - 03.6154C
SNAP-ON - 03.6151C
WÜRTH - 03.6150C

Accessories

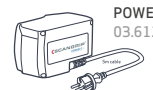

POWER SUPPLY
03.6123C



CAS BATTERY
12V 4.0 Ah
03.6120



CAS BATTERY
18V 5.2 Ah
03.6121



CAS CHARGER
03.6122

3
years
warranty

PATENT PROTECTED

// Portable work light

NOVA 2 CONNECT features the latest high-performance COB LED technology and provides up to 2000 lumen. The built-in light dimmer function makes it possible to adjust the light into five different steps according to the work task. It is also supplied with display for battery capacity and lumen output level.

NOVA 2 CONNECT is compatible with METABO / CAS battery system 12V 4.0 Ah - 18V 5.2 Ah and all other 18V battery packs from leading power tool brands by using the SCANGRIP CONNECTOR. In addition, the POWER SUPPLY can be used for direct power providing unlimited availability to light.

Due to the flexible stand and built-in hook, NOVA 2 CONNECT can be placed in different positions to obtain the desired lighting angle.

The housing is made of sturdy die-casted aluminum and resistant to strokes, shocks and vibrations. The durable construction makes NOVA 2 CONNECT perfect for the demanding, rough working environment.

As an extra feature, it has a built-in powerbank with USB outlet to charge mobile devices.

EU DESIGN
PATENT
213346



Light dimmable in 5 steps



NOVA 2 CONNECT

€ 89.90

03.6100C

Work light providing up to 2000 lumen

JUST CONNECT

Add the connector matching your 18V battery pack



Use the SCANGRIP CONNECTOR to attach your 18V battery pack on the NOVA 2 CONNECT lamp



Use the POWER SUPPLY for direct power



Hook for flexible positioning

NOVA CONNECT - High efficiency and powerful COB LED floodlights

// The extremely sturdy NOVA CONNECT floodlights provide powerful illumination and feature BLUETOOTH light control for increased work efficiency.

- Powerful work lights up to 10,000 lumen
- Integrated backup battery functionality
- Long operation time
- Extremely durable with high IP (IP65)
- BLUETOOTH light control app

ORIGINAL
SCANGRIP
SINCE 1906



BATTERY, CHARGER, CONNECTORS AND POWER SUPPLY ARE SOLD SEPARATELY

SCANGRIP CONNECTORS for 18V battery packs



BERNER - 03.6155C
BOSCH - 03.6140C
BOSCH GREEN - 03.6141C
DEWALT - 03.6142C
EINHELL - 03.6143C
FEIN - 03.6144C
FESTOOL - 03.6153C
FLEX - 03.6145C
HAZET - 03.6146C
HIKOKI - 03.6147C
INGERSOLL - 03.6152C
MAKITA - 03.6148C
MILWAUKEE - 03.6149C
RIDGID - 03.6154C
SNAP-ON - 03.6151C
WÜRTH - 03.6150C

Accessories



POWER SUPPLY
03.6123C



CAS BATTERY
12V 4.0 Ah
03.6120



CAS BATTERY
18V 5.2 Ah
03.6121



CAS CHARGER
03.6122

3
years
warranty

PATENT PROTECTED



Use the SCANGRIP CONNECTOR to attach your 18V battery pack on the NOVA CONNECT lamp



Use the POWER SUPPLY for direct power

EU DESIGN PATENT 213346

// Unlimited availability to light

The extremely powerful NOVA 4 CONNECT and NOVA 10 CONNECT provide up to 4000 lumen and 10000 lumen respectively, and are compatible with METABO/CAS battery system 12V 4.0 Ah - 18V 5.2 Ah and all other 18V battery packs from leading power tool brands by using the SCANGRIP CONNECTOR. In addition, the POWER SUPPLY can be used for direct power providing unlimited availability to light.

They are designed with a display for battery capacity and lumen output level, and supplied with a built-in powerbank. The work lights are also supplied with an integrated battery backup function securing you extra operating time to finish the job.

The NOVA CONNECT work lights are extremely sturdy and waterproof (IP65). The design is elegant, with a carrying handle and a stand for flexible positioning and direct mounting on the SCANGRIP TRIPOD.

// BLUETOOTH light control

With the user-friendly BLUETOOTH light control app, you get an extraordinary possibility to turn on/off and control up to four work lights through a mobile device. The built-in dimmer function enables you to adjust the light output into five different levels. This feature saves time from manual operation and increases work efficiency on a daily basis.



BLUETOOTH - Light control app

- Dimmer light output into 5 levels 10 %-100 %
- Switch on/off, check battery
- Group control function, up to 4 lamps
- Assign pin code

Compliant with iPhone 5 or higher / Android 5.0 or higher. Go to iTunes App Store to download the app or download the app from scangrip.com



NOVA 4 CONNECT

€ 169.90

03.6101C

Work light with BLUETOOTH providing up to 4000 lumen



NOVA 10 CONNECT

€ 269.90

03.6102C

Work light with BLUETOOTH providing up to 10000 lumen



Convenient, built-in carrying handle



// Built-in powerbank

VEGA CONNECT – Powerful and uniform LED floodlights



// The illumination of the VEGA CONNECT work lights provide a diffused and pleasant, non-blinding, uniform light with a large dispersion, perfect for any kind of work.

- Diffused, non-blinding light, up to 4000 lumen
- Portable due to compact design and low weight
- Made of a highly shock-resistant plastic material
- High IP54



BATTERY, CHARGER, CONNECTORS AND POWER SUPPLY ARE SOLD SEPARATELY

SCANGRIP CONNECTors for 18V battery packs



- BERNER - 03.6155C
- BOSCH - 03.6140C
- BOSCH GREEN - 03.6141C
- DEWALT - 03.6142C
- EINHELL - 03.6143C
- FEIN - 03.6144C
- FESTOOL - 03.6153C
- FLEX - 03.6145C
- HAZET - 03.6146C
- HIKOKI - 03.6147C
- INGERSOLL - 03.6152C
- MAKITA - 03.6148C
- MILWAUKEE - 03.6149C
- RIDGID - 03.6154C
- SNAP-ON - 03.6151C
- WÜRTH - 03.6150C

Accessories



POWER SUPPLY
03.6123C



CAS BATTERY
18V 5.2 Ah
03.6121



CAS CHARGER
03.6122

3
years
warranty

// Powerful, diffused LED light

The powerful VEGA 2 CONNECT and VEGA 4 CONNECT provide up to 2000 lumen and 4000 lumen respectively. The powerful LEDs provide a diffused and pleasant, non-blinding, uniform work light, with a large dispersion, perfect for painting and installation work. It features 2 level light output (50-100%) which makes it possible to adjust the light according to the work task.

The floodlights are compatible with METABO/CAS battery system 18V 5.2 Ah and all other 18V battery packs from leading power tool brands by using the SCANGRIP CONNECTOR. In addition, the POWER SUPPLY can be used for direct power providing unlimited availability to light.

// High flexibility and durability

The VEGA CONNECT floodlights come with an integrated carrying handle and a stand for tripod mounting which make it very convenient and easy to position the light where it is needed.

The robust housing is made of a highly shock-resistant plastic material, perfect for a working environment. It is also waterproof (IP54). Since the LEDs do not produce heat, there is no fire hazard when using the floodlight.

EU DESIGN
PATENT
213346

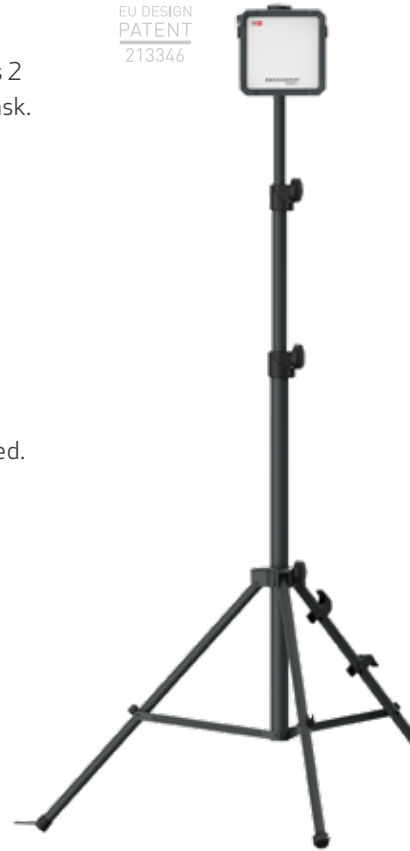

VEGA 2 CONNECT

€ 74.90

03.6106C

Floodlight providing up to 2000 lumen



VEGA 4 CONNECT

€ 119.90

03.6104C

Floodlight providing up to 4000 lumen



Use the SCANGRIP CONNECTOR to attach your 18V battery pack on the VEGA CONNECT lamp

Use the POWER SUPPLY for direct power

AREA 10 CONNECT – 10,000 lumen high efficiency 360° work light



// Compact and portable area work light with many applications. Providing a diffused and uniform light, it is ideal for the professional user who requires powerful and efficient illumination of the entire worksite.



- Diffused, non-blinding light, up to 10,000 lumen
- Portable due to compact design and low weight
- High IP65
- BLUETOOTH light control app

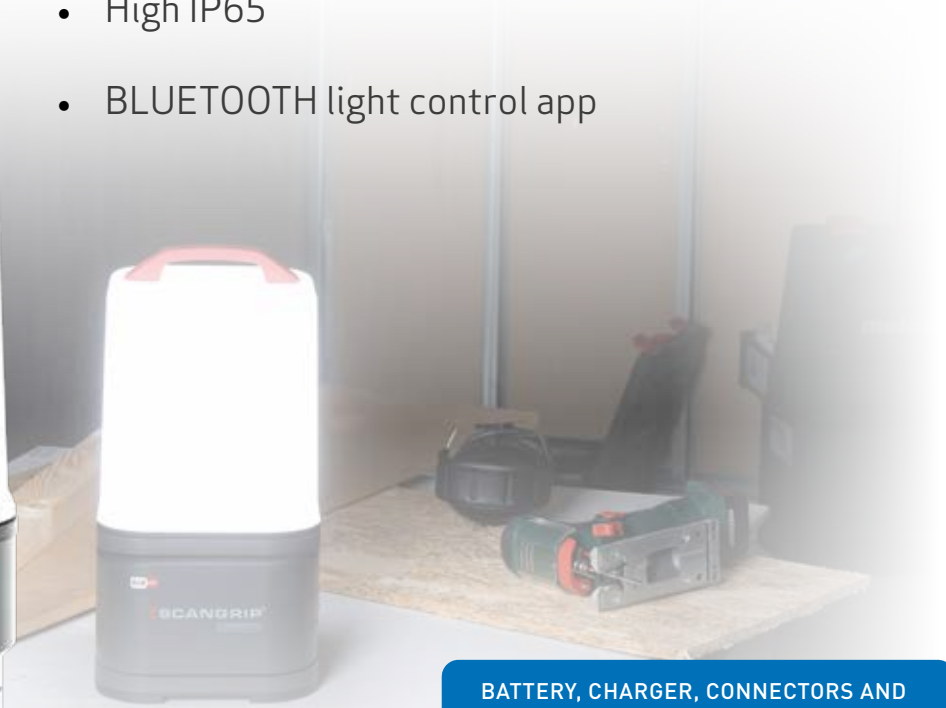





BATTERY, CHARGER, CONNECTORS AND POWER SUPPLY ARE SOLD SEPARATELY

SCANGRIP CONNECTORS for 18V battery packs

- BERNER - 03.6155C
- BOSCH - 03.6140C
- BOSCH GREEN - 03.6141C
- DEWALT - 03.6142C
- EINHELL - 03.6143C
- FEIN - 03.6144C
- FESTOOL - 03.6153C
- FLEX - 03.6145C
- HAZET - 03.6146C
- HIKOKI - 03.6147C
- INGERSOLL - 03.6152C
- MAKITA - 03.6148C
- MILWAUKEE - 03.6149C
- RIDGID - 03.6154C
- SNAP-ON - 03.6151C
- WÜRTH - 03.6150C

Accessories

-  POWER SUPPLY 03.6123C
-  CAS BATTERY 12V 4.0 Ah 03.6120
-  CAS BATTERY 18V 5.2 Ah 03.6121
-  CAS CHARGER 03.6122

3 years warranty



// Powerful illumination of the entire worksite

AREA 10 CONNECT provides a diffused and non-blinding work light with large dispersion. You can change between 360° and 180° illumination according to the work task and adjust the light output into five different levels by the built-in dimmer function. The compact design with a carrying handle makes AREA 10 CONNECT extremely handy and easy to move around. It is also supplied with a hook for flexible positioning and can be mounted directly on the SCANGRIP TRIPOD.

// High flexibility and long operating time

AREA 10 CONNECT is compatible with METABO / CAS battery system 12V 4.0 Ah - 18V 5.2 Ah and all other 18V battery packs from leading power tool brands by using the SCANGRIP CONNECTOR. In addition, the POWER SUPPLY can be used for direct power providing unlimited availability to light. AREA 10 CONNECT also has an internal back-up battery securing 50 extra minutes at 1000 lumen.

// BLUETOOTH light control

With the integrated BLUETOOTH light control it is possible to turn on/off the work light and adjust the light output through a mobile device, saving you time from manual operation and increases work efficiency on a daily basis.

EU DESIGN
PATENT
213346



Bluetooth[®]

BLUETOOTH - Light control app

- Dimmer light output into 5 levels 10 %-100 %
- Change between 360° and 180° illumination
- Switch on/off, check battery
- Group control function, up to 4 lamps
- Assign pin code

Compliant with iPhone 5 or higher / Android 5.0 or higher. Go to iTunes App Store to download the app or download the app from scangrip.com



Bluetooth AREA 10 CONNECT

€ 269.90

03.6103C

360° work light with BLUETOOTH providing up to 10000 lumen



Hook for flexible positioning



Use the SCANGRIP CONNECTOR to attach your 18V battery pack on the AREA 10 CONNECT lamp

Use the POWER SUPPLY for direct power



Built-in powerbank

AREA 6 CONNECT - 6000 lumen high efficiency 360° work light

// 360° high performance LED work light with powerful and diffused light for any kind of repair, paint or construction work.

- Powerful, diffused, non-blinding illumination
- 2 level light output (50-100%)
- Compact and lightweight design

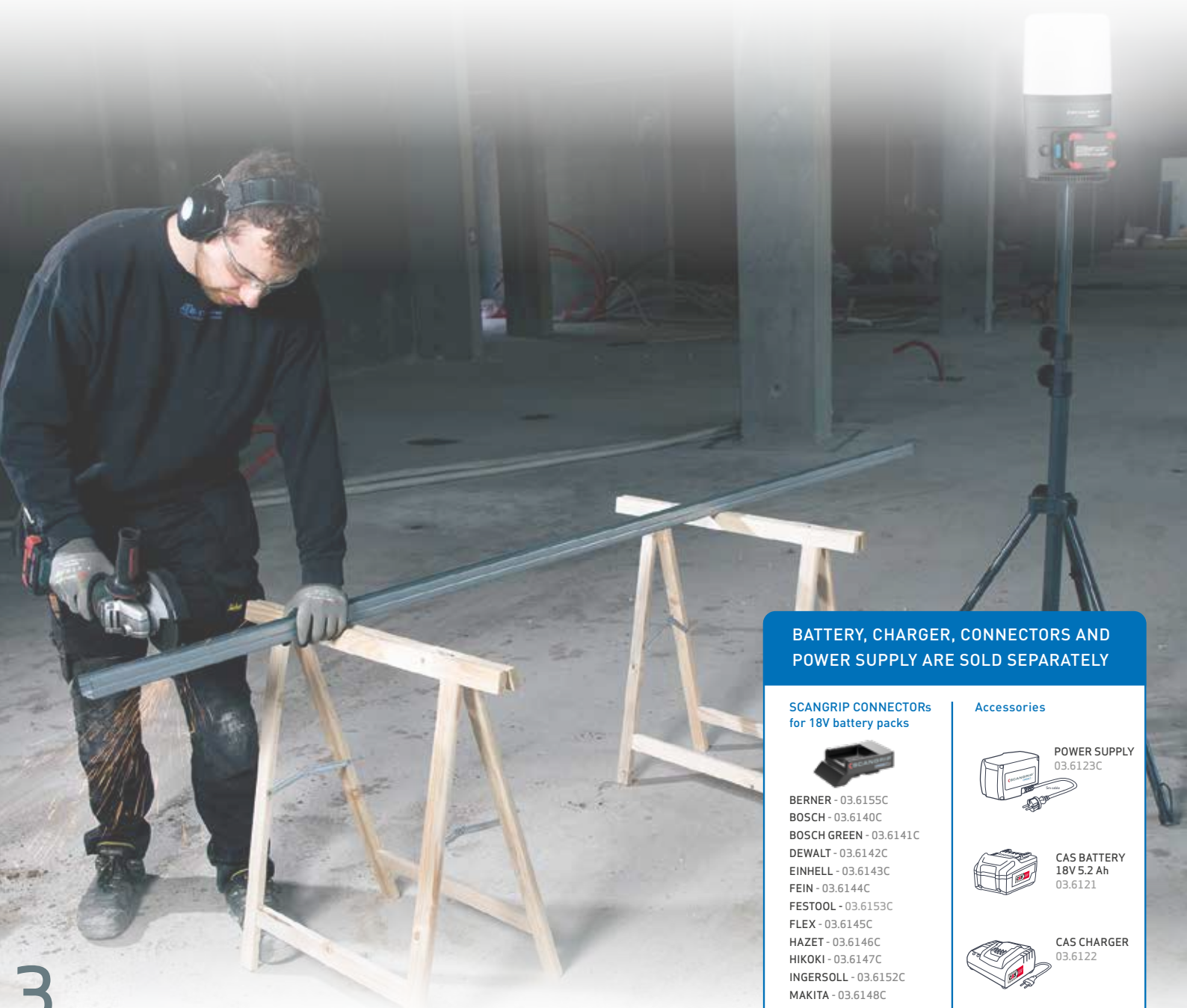

BATTERY, CHARGER, CONNECTORS AND POWER SUPPLY ARE SOLD SEPARATELY

SCANGRIP CONNECTORS for 18V battery packs



- BERNER - 03.6155C
- BOSCH - 03.6140C
- BOSCH GREEN - 03.6141C
- DEWALT - 03.6142C
- EINHELL - 03.6143C
- FEIN - 03.6144C
- FESTOOL - 03.6153C
- FLEX - 03.6145C
- HAZET - 03.6146C
- HIKOKI - 03.6147C
- INGERSOLL - 03.6152C
- MAKITA - 03.6148C
- MILWAUKEE - 03.6149C
- RIDGID - 03.6154C
- SNAP-ON - 03.6151C
- WÜRTH - 03.6150C

Accessories



POWER SUPPLY
03.6123C



CAS BATTERY
18V 5.2 Ah
03.6121



CAS CHARGER
03.6122

3
years
warranty

// Powerful 360° illumination of the working area

The AREA 6 CONNECT is a real basic work light providing a diffused and pleasant, non-blinding light up to 6000 lumen. It features 2 level light output (50-100%) which makes it possible to adjust the light according to the work task.

AREA 6 CONNECT is compatible with METABO / CAS battery system 18V 5.2 Ah and all other 18V battery packs from leading power tool brands by using the SCANGRIP CONNECTOR. In addition, the POWER SUPPLY can be used for direct power providing unlimited availability to light.

// Flexible positioning

Due to the compact and lightweight design, AREA 6 CONNECT is portable and easy to carry around. It is also supplied with a hook for flexible positioning and can be mounted directly on the SCANGRIP TRIPOD.

EU DESIGN
PATENT
4070035



AREA 6 CONNECT

€ 169.90

03.6108C

360° work light providing up to 6000 lumen



Use the SCANGRIP CONNECTOR to attach your 18V battery pack on the AREA 6 CONNECT lamp



Use the POWER SUPPLY for direct power

TOWER 5 CONNECT - 5000 lumen floodlight with integrated tripod

// Featuring two built-in floodlights, TOWER 5 CONNECT is ideal for the professional user who requires powerful and efficient illumination on the worksite.



- Integrated tripod with two built-in floodlights providing up to 5000 lumen
- 360° flexible and turnable floodlights
- QUICK-FOLD system
- Compact and lightweight design

BATTERY, CHARGER, CONNECTORS AND POWER SUPPLY ARE SOLD SEPARATELY

SCANGRIP CONNECTORS for 18V battery packs



BERNER - 03.6155C
BOSCH - 03.6140C
BOSCH GREEN - 03.6141C
DEWALT - 03.6142C
EINHELL - 03.6143C
FEIN - 03.6144C
FESTOOL - 03.6153C
FLEX - 03.6145C
HAZET - 03.6146C
HIKOKI - 03.6147C
INGERSOLL - 03.6152C
MAKITA - 03.6148C
MILWAUKEE - 03.6149C
RIDGID - 03.6154C
SNAP-ON - 03.6151C
WÜRTH - 03.6150C

Accessories



POWER SUPPLY
03.6123C



CAS BATTERY
18V 5.2 Ah
03.6121



CAS CHARGER
03.6122



3
years
warranty

PATENT PROTECTED

// High flexibility

Featuring 360° flexible and turnable floodlights, the lights can be positioned in any direction to obtain the desired lighting angle, providing perfect lighting condition for painting and installation work. TOWER 5 CONNECT is extendable up to 2 meters and features 2 level light output (50-100%) which makes it possible to adjust the light according to the work task.

TOWER 5 CONNECT is compatible with METABO/CAS battery system 18V 5.2 Ah and all other 18V battery packs from leading power tool brands by using the SCANGRIP CONNECTOR. In addition, the POWER SUPPLY can be used for direct power providing unlimited availability to light.



// Slim design and lightweight

TOWER 5 CONNECT is the ideal mobile work light. Featuring a QUICK-FOLD system, it is fast to set up the tripod in only a few seconds and fold again when the job is done.

In folded position, the TOWER 5 CONNECT is compact and designed for one-hand transport with the integrated carrying handle. The sturdy, slim design and low weight of only 5.2 kg makes the TOWER 5 CONNECT tailored to bring around in the back of the car and convenient to carry around from one worksite to the other.



Use the POWER SUPPLY for direct power

TOWER 5 CONNECT

€ 229.90

03.6105C

Floodlight with built-in tripod providing up to 5000 lumen

JUST CONNECT

Add the connector matching your 18V battery pack



Use the SCANGRIP CONNECTOR to attach your 18V battery pack on the TOWER 5 CONNECT lamp



STANDS and SUSPENSIONS



// Designed for direct mounting of the NOVA CONNECT, AREA CONNECT and VEGA CONNECT work lights. Made of durable and sturdy powder coated steel for both indoor and outdoor use.

// High stability tripod

The SCANGRIP TRIPOD is indispensable for stationary positioning of the work light for illumination in a specific working area. The SCANGRIP TRIPOD is extendable from only 1.35 m up to 3 m which gives you complete flexibility to position the light in the requested height.

The stable construction of the SCANGRIP TRIPOD 3M makes it safe even when fully extended. It is supplied with anchor points that provide an opportunity for extra stability if the tripod is exposed to strong wind or standing on an uneven surface. To increase safety when in use, the cable of the lamp can be fixed in the safety clips placed on each separate leg.

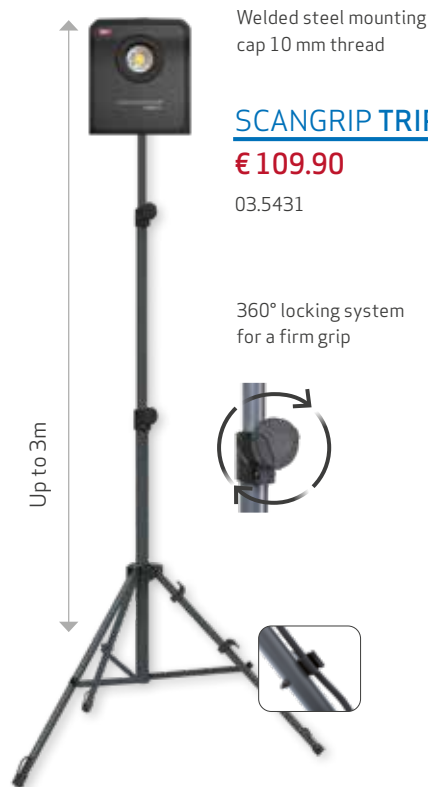

SCANGRIP TRIPOD 3M

€ 109.90

03.5431

// Lightweight TRIPOD with QUICK RELEASE function



With its lightweight and extremely handy design, the SCANGRIP TRIPOD 2M is indispensable for stationary positioning of the work light for illumination in a specific working area. The tripod is extendable from 0.9 meter up to 2 meters, which gives you complete flexibility to position the light in the requested height. When mounted on the tripod the light can be tilted to provide the optimum beam angle.

Featuring a compact design and QUICK RELEASE function, it is easy and convenient to carry the tripod and set it up where illumination is needed. The tripod is extremely durable and can be applied for both indoor and outdoor use. The stable construction makes it safe even when fully extended. It is made of black painted aluminum.

QUICK RELEASE function



SCANGRIP TRIPOD 2M

€ 79.90

03.5685

2.1 kg
Max load 5 kg

Lightweight
Easy to carry

DUAL BRACKET not applicable.

// Wheel stand for mobile positioning

The SCANGRIP WHEEL STAND makes it easy to move the light to where you need it, and at the same time you avoid uncomfortable and heavy lifting from one workplace to the other. It is upgraded with a new base which is equipped with 5 wheels for improved safety and stability and easy maneuverability.

As an additional feature, it now comes with a flexible bracket that enables you to easily position a second work light to illuminate from below. The extra mounting bracket is adjustable in the height and provides complete flexibility to position the light in the optimum height.



WHEEL STAND

€ 139.90

03.5682

// Suspensions for flexible positioning

DUAL BRACKET

€ 24.90

03.5308



Dual bracket for positioning of two lamps on TRIPOD or WHEELSTAND

SCAFFOLDING BRACKET

€ 29.90

03.5341



For flexible positioning on scaffoldings or any round object ø40-50 mm

MAGNET BRACKET

€ 29.90

03.5390



For flexible positioning of NOVA 4 CONNECT work light on any magnetic surface

MAGNET BRACKET - Large

€ 49.90

03.5391



For flexible positioning of NOVA 10 CONNECT work light on any magnetic surface

// SCANGRIP DIFFUSER provides a large dispersion and spreads the light

Enlightens the entire working area, even into the darkest corner and softens the light avoiding hard shadows. Minimizes reflections and harsh light and provides non-blinding work light.

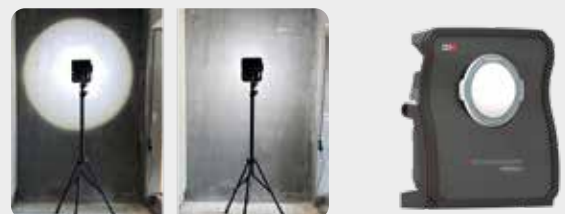

Easy and safe mounting with strong magnets

SCANGRIP DIFFUSER

€ 9.90

03.5750

Fits NOVA 4 CONNECT

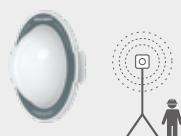

SCANGRIP DIFFUSER - Large

€ 14.90

03.5751

Fits NOVA 10 CONNECT

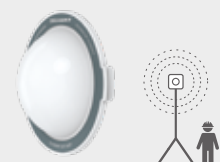

NOVA CONNECT series



	NOVA 2 CONNECT	NOVA 4 CONNECT	NOVA 10 CONNECT
Product number	03.6100C	03.6101C	03.6102C
Light source	High efficiency COB LED	High efficiency COB LED	High efficiency COB LED
LED performance, lumen/W	165	160	165
Luminous flux, lumen	200-2000	400-4000	1000-10000
Illuminance, lux@0.5 m	300-3000	600-6000	1600-16000
Adjustable light output	5 levels	5 levels	5 levels
Beam angle	110°	110°	110°
CRI	Ra > 80	Ra > 80	Ra > 80
CCT	6000 K	6000 K	6000 K
Operating time with max. lumen, h	2.5@12V 4.0 Ah battery 5.75@18V 5.2 Ah battery	1.5@12V 4.0 Ah battery 3@18V 5.2 Ah battery	0.5@12V 4.0 Ah battery 1.25@18V 5.2 Ah battery
Operating time with min. lumen, h	27@12V 4.0 Ah battery 58@18V 5.2 Ah battery	14@12V 4.0 Ah battery 31@18V 5.2 Ah battery	5.5@12V 4.0 Ah battery 12@18V 5.2 Ah battery
Operating time: backup battery, h	-	2.5@10% / 400 lm	1@10% / 1000 lm
Battery	Compatible with METABO / CAS battery system 12V 4.0 Ah - 18V 5.2 Ah and all other 18V battery packs by using the SCANGRIP CONNECTOR	Compatible with METABO / CAS battery system 12V 4.0 Ah - 18V 5.2 Ah and all other 18V battery packs by using the SCANGRIP CONNECTOR	Compatible with METABO / CAS battery system 12V 4.0 Ah - 18V 5.2 Ah and all other 18V battery packs by using the SCANGRIP CONNECTOR
Protection class	IP30	IP65	IP65
Impact protection	IK07	IP54 with battery cover	IP54 with battery cover
Impact resistance	1 m	IK07	IK07
Charger input voltage	-	1 m	1 m
Power consumption	Max 16 W	-	-
Battery incl.	No	Max 30 W	Max 75 W
Charger incl.	No	No	No
Power supply Incl.	No	No	No
Temperature	-10° to +40°C	-10° to +40°C	-10° to +40°C
Dimensions	161 x 164 x 78 mm	263x230x119mm	304x292x131mm
Net weight	720g	2.35 kg	3.72 kg
Price	€ 89.90	€ 169.90	€ 269.90

BERNER - BOSCH - BOSCH GREEN - DEWALT - EINHELL - FEIN - FESTOOL - FLEX - HAZET

HIKOKI - INGERSOLL - MAKITA - METABO - MILWAUKEE- RIDGID - SNAP-ON - WÜRTH

VEGA CONNECT series



	VEGA 2 CONNECT	VEGA 4 CONNECT
Product number	03.6106C	03.6104C
Light source	60 LEDs	105 LEDs
 LED performance, lumen/W	189	189
Luminous flux, lumen	1000 / 2000 (step 1 / 2)	2000 / 4000 (step 1 / 2)
Illuminance, lux@0.5 m	1500 / 3000 (step 1 / 2)	3000 / 6000 (step 1 / 2)
Adjustable light output	2 levels	2 levels
Beam angle	100°	100°
CRI	Ra > 80	Ra > 80
CCT	6500 K	6500 K
Operating time with max. lumen, h	4.5@18V 5.2 Ah battery	2.25@18V 5.2 Ah battery
Operating time with min. lumen, h	9@18V 5.2 Ah battery	4.5@18V 5.2 Ah battery
Operating time: backup battery, h	-	-
Battery	Compatible with METABO / CAS battery system 18V 5.2 Ah and all other 18V battery packs by using the SCANGRIP CONNECTOR	Compatible with METABO / CAS battery system 18V 5.2 Ah and all other 18V battery packs by using the SCANGRIP CONNECTOR
Protection class	IP54 with power supply IP30 with battery	IP54 with power supply IP30 with battery
Impact protection	IK06	IK07
Impact resistance	1 m	1 m
Charger input voltage	-	-
Power consumption	Max 20W	Max 40 W
Battery incl.	No	No
Charger incl.	No	No
Power supply incl.	No	No
Temperature	-10° to +40°C	-10° to +40°C
Dimensions	200x208x78mm	280x289x103mm
Net weight	850g	2.02 kg
Price	€ 74.90	€ 119.90

AREA CONNECT series



TOWER 5 CONNECT



	AREA 10 CONNECT	AREA 6 CONNECT	TOWER 5 CONNECT
Product number	03.6103C	03.6108C	03.6105C
Light source	240 LEDs	160 LEDs	120 LEDs
LED performance, lumen/W	189	189	189
Luminous flux, lumen	360°: 1000-10000 / 180°: 500-5000	3000 / 6000 (step 1 / 2)	2500 / 5000 (step 1 / 2)
Illuminance, lux@0.5 m	300-3000	1500 / 3000 (step 1 / 2)	4000 / 8000 (step 1 / 2)
Adjustable light output	5 levels	2 levels	2 levels
Beam angle	360° / 180°	360°	110°
CRI	Ra > 80	Ra > 80	Ra > 80
CCT	6500 K	6500 K	6000 K
Operating time with max. lumen, h	0.5@12V 4.0 Ah battery 1@18V 5.2 Ah battery	1.75@18V 5.2 Ah battery	2@18V 5.2 Ah battery
Operating time with min. lumen, h	10@12V 4.0 Ah battery 22@18V 5.2 Ah battery	6.5@18V 5.2 Ah battery	4.5@18V 5.2 Ah battery
Operating time: backup battery, h	50min@10% / 1000 lm	-	-
Battery	Compatible with METABO / CAS battery system 12V 4.0 Ah - 18V 5.2 Ah and all other 18V battery packs by using the SCANGRIP CONNECTOR	Compatible with METABO / CAS battery system 18V 5.2 Ah and all other 18V battery packs by using the SCANGRIP CONNECTOR	Compatible with METABO / CAS battery system 18V 5.2 Ah and all other 18V battery packs by using the SCANGRIP CONNECTOR
Protection class	IP65 IP54 with battery cover	P54 with power supply IP30 with battery	IP30
Impact protection	IK07	IK07	IK07
Impact resistance	1 m	1 m	1 m
Charger input voltage	-	-	-
Power consumption	Max 84 W	Max 54 W	Max 45 W
Battery incl.	No	No	No
Charger incl.	No	No	No
Power supply incl.	No	No	No
Temperature	-10° to +40°C	-10° to +40°C	-10° to +40°C
Dimensions	395x200x212mm	ø195x363mm	121x153x892mm
Net weight	3.7 kg	1.97kg	5.2 kg
Price	€ 269.90	€ 169.90	€ 229.90

CONNECTORS

SCANGRIP CONNECTORs for 18V battery packs		Price
BERNER	03.6155C	€ 9.90
BOSCH	03.6140C	€ 9.90
BOSCH GREEN	03.6141C	€ 9.90
DEWALT	03.6142C	€ 9.90
EINHELL	03.6143C	€ 9.90
FEIN	03.6144C	€ 9.90
FESTOOL	03.6153C	€ 9.90
FLEX	03.6145C	€ 9.90
HAZET	03.6146C	€ 9.90
HIKOKI	03.6147C	€ 9.90
INGERSOLL	03.6152C	€ 9.90
MAKITA	03.6148C	€ 9.90
MILWAUKEE	03.6149C	€ 9.90
RIDGID	03.6154C	€ 9.90
SNAP-ON	03.6151C	€ 9.90
WÜRTH	03.6150C	€ 9.90



Accessories



	CONNECT POWER SUPPLY	CAS BATTERY 12V LiHD 4.0Ah	CAS BATTERY 18V Li-POWER 5.2Ah	CAS CHARGER SC30
Product number	03.6123C	03.6120	03.6121	03.6122
Battery	-	12V 4.0Ah Li-ion	18V 5.2Ah Li-power	-
Cable	5m 2x0.75mm ² H05RN-F	-	-	1.35m 2x0.75mm ² H03V VH2-F
Charger input voltage	100-240V AC 50/60Hz	-	-	220-240V AC 50/60Hz
Output power	Max 90 W	-	-	Max 30 W
Charging time, h	-	92min@100% with CAS charger 03.6122	208min@100% with CAS charger 03.6122	-
Protection class	IP65	IP20	IP20	IP20
Impact protection	IK07	-	-	-
Impact resistance	1 m	-	-	-
Temperature	-10° to +40°C	-10° to +40°C	-10° to +40°C	0° to +40°C
Dimensions	124x83x72mm	88x75x40mm	121x80.5x66mm	150x140x75mm
Net weight	1 kg	325 g	670 g	700 g
Compatibility	SCANGRIP CONNECT work lights	-	-	12V-18V CAS battery
Price	€ 69.90	€ 69.90	€ 134.90	€ 49.90

BERNER - BOSCH - BOSCH GREEN - DEWALT - EINHELL - FEIN - FESTOOL - FLEX - HAZET
 HIKOKI - INGERSOLL - MAKITA - METABO - MILWAUKEE - RIDGID - SNAP-ON - WÜRTH

SCANGRIP PRODUCT LINES



Professional range of work lights with unmatched value for money



Specialized work lights for the painting industry



Explosion proof lights

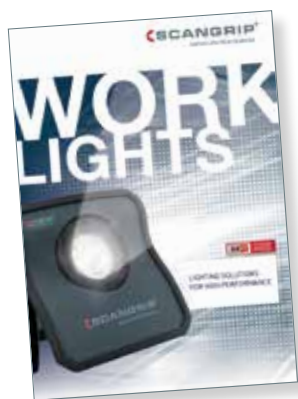

Lighting solutions for high performance



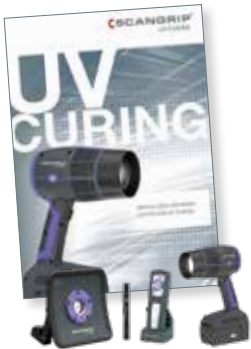

Portable lights for fast curing



3
years
warranty

Designed by us. Manufactured by us.

PATENT PROTECTED



// SCANGRIP is Europe's leading manufacturer of work lights for professionals providing the strongest and most comprehensive ranges of work lights with the latest LED lighting technology available on the market.

SCANGRIP is innovation from Denmark and receives strong recognition in the marketplace for its product design, and the products are known for their high quality.

SCANGRIP strives for perfection, and is continuously optimizing and improving light output, battery capacity, design and ergonomics, durability, user-friendliness, and functionality. The aim is to set new standards for professional work lights.

SCANGRIP was established in 1906 and has a long, impressive history of manufacturing high-quality hand tools and work lights for the industrial, construction, and automotive sectors.

SCANGRIP is part of Hultafors Group - a global company offering a unique portfolio of premium brands within personal protection, tools, and other equipment for discerning craftsmen. Together, we are on a mission to create a better day for professional users.