

GNS-3911Ax-Bx-Cx-Dx (SINGLE DIGIT LED DISPLAY)

GNS-3911 Series

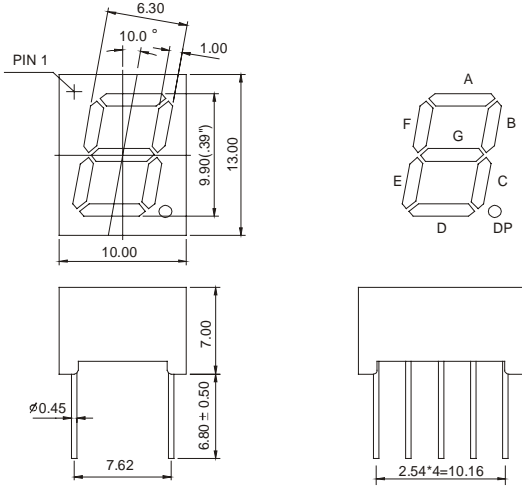

GNS-3911Ax

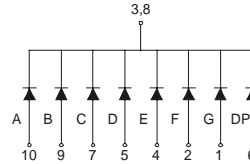

GNS-3911Bx

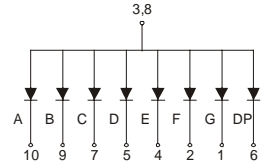

GNS-3911Cx

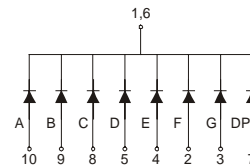

GNS-3911Dx

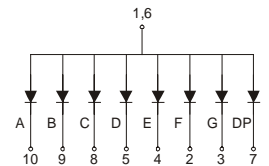

Features:

*0.39 INCH HIGH CHARACTER.

*EXCELLENT CHARACTER APPEARANCE.

*COMMON CATHODE OR COMMON ANODE.

*I.C. COMPATIBLE.

*LOW POWER CONSUMPTION.

Part Number	EMITTED COLOR		Common Cathode or Common Anode	Peak Wavelength (nm)	Vf (v) Typ	If (mA)	Intensity Per Segment (mcd)	
							Min.	Typ.
GNS-3911AE	GaAsP/GaP	Hi.effi Red	Common Cathode	635	2.0	20	9	12
GNS-3911AG	GaP	Green		565	2.1	20	8	11
GNS-3911AY	GaAsP/GaP	Yellow		585	2.0	20	9	12
GNS-3911AS	GaAlAs	Super Red		660	1.8	20	10	13
GNS-3911AD	GaAlAs	Ultra Red		660	1.8	20	25	30
GNS-3911AUE	AlGaInP	Ultra Red		625	2.0	20	30	35
GNS-3911AUY	AlGaInP	Ultra Yellow		590	2.0	20	30	35
GNS-3911BE	GaAsP/GaP	Hi.effi Red	Common Anode	635	2.0	20	9	12
GNS-3911BG	Gap	Green		565	2.1	20	8	11
GNS-3911BY	GaAsP/GaP	Yellow		585	2.0	20	9	12
GNS-3911BS	GaAlAs	Super Red		660	1.8	20	10	13
GNS-3911BD	GaAlAs	Super Red		660	1.8	20	25	30
GNS-3911BUE	AlGaInP	Ultra Red		625	2.0	20	30	35
GNS-3911BUY	AlGaInP	Ultra Yellow		590	2.0	20	30	35

GNS-3911CE	GaAsP/GaP	Hi.effi Red	Common Cathode	635	2.0	20	9	12
GNS-3911CG	GaP	Green		565	2.1	20	8	11
GNS-3911CY	GaAsP/GaP	Yellow		585	2.0	20	9	12
GNS-3911CS	GaAlAs	Super Red		660	1.8	20	10	13
GNS-3911CD	GaAlAs	Ultra Red		660	1.8	20	25	30
GNS-3911CUE	AlGaInP	Ultra Red		625	2.0	20	30	35
GNS-3911CUY	AlGaInP	Ultra Yellow		590	2.0	20	30	35
GNS-3911DE	GaAsP/GaP	Hi.effi Red		Common Anode	635	2.0	20	9
GNS-3911DG	Gap	Green	565		2.1	20	8	11
GNS-3911DY	GaAsP/GaP	Yellow	585		2.0	20	9	12
GNS-3911DS	GaAlAs	Super Red	660		1.8	20	10	13
GNS-3911DD	GaAlAs	Super Red	660		1.8	20	25	30
GNS-3911DUE	AlGaInP	Ultra Red	625		2.0	20	30	35
GNS-3911DUY	AlGaInP	Ultra Yellow	590		2.0	20	30	35