

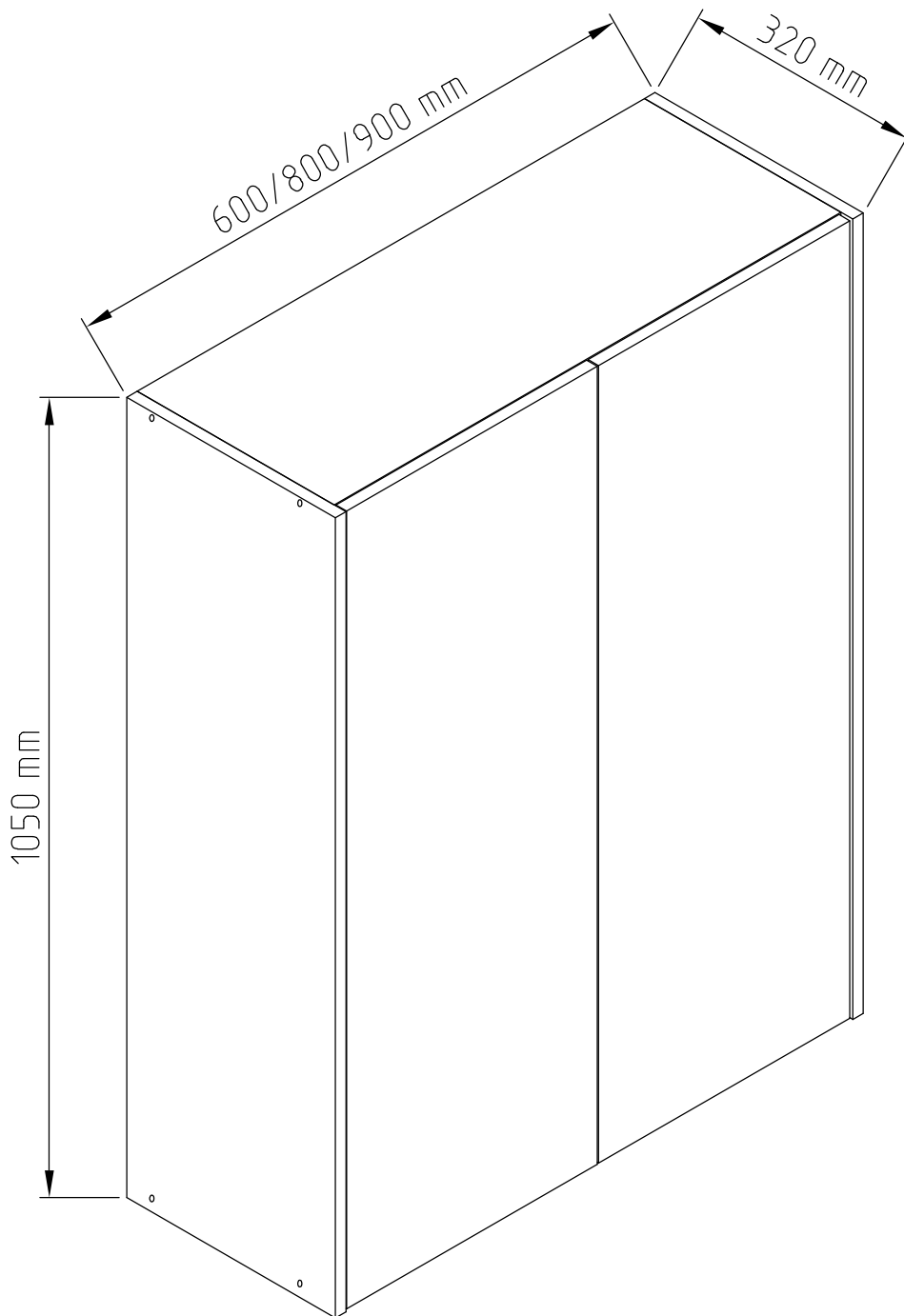

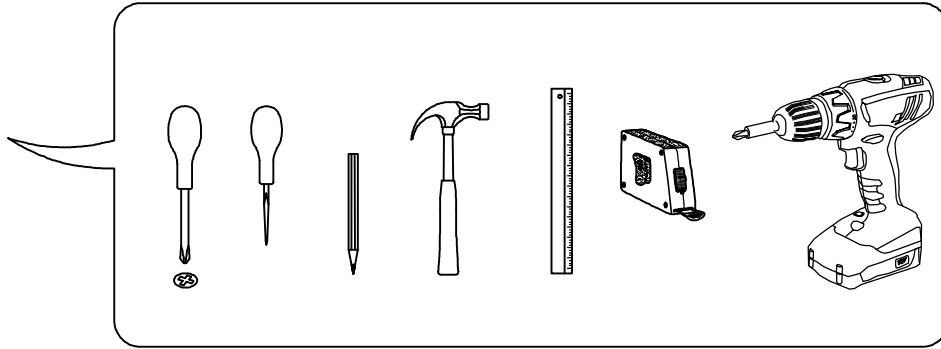

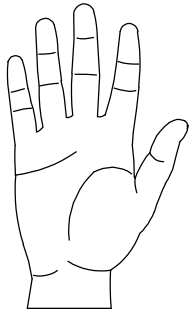

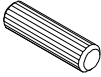

# **B 60/80/90 2D (1050)**

**ΓΡΑΦΙΤΙ (GRAFFITI)**

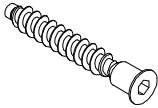
**U 60/80/90 2D (1050)**

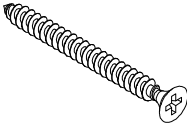

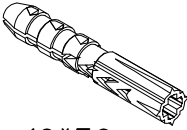
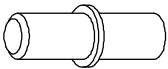
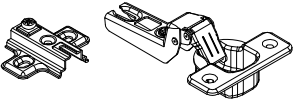
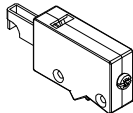
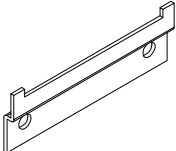
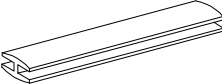
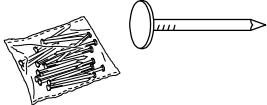
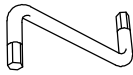

 <b>A1</b> 8*30mm x8	 <b>B</b> $\phi$ 12mm x8	 <b>B1</b> 6,3*50mm x8
 <b>E12</b> 4*16mm x8	 <b>E15</b> 4*30mm x8	 <b>E25</b> 6*60mm x4
 <b>F4</b> 6,3*13mm x8	 <b>H6</b> 10*50mm x4	 <b>J1</b> 5*16mm x8
 <b>L3</b> x4	 <b>N1</b> x2	 <b>O4</b> x2
 <b>O8</b> L-1006 mm x1 (x2)	 <b>R3</b> 1.4*25mm 0.020kg	 <b>R4</b> N°4 x1
 <b>U3</b> x4		

# **B 60/80/90 2Д (1050)**

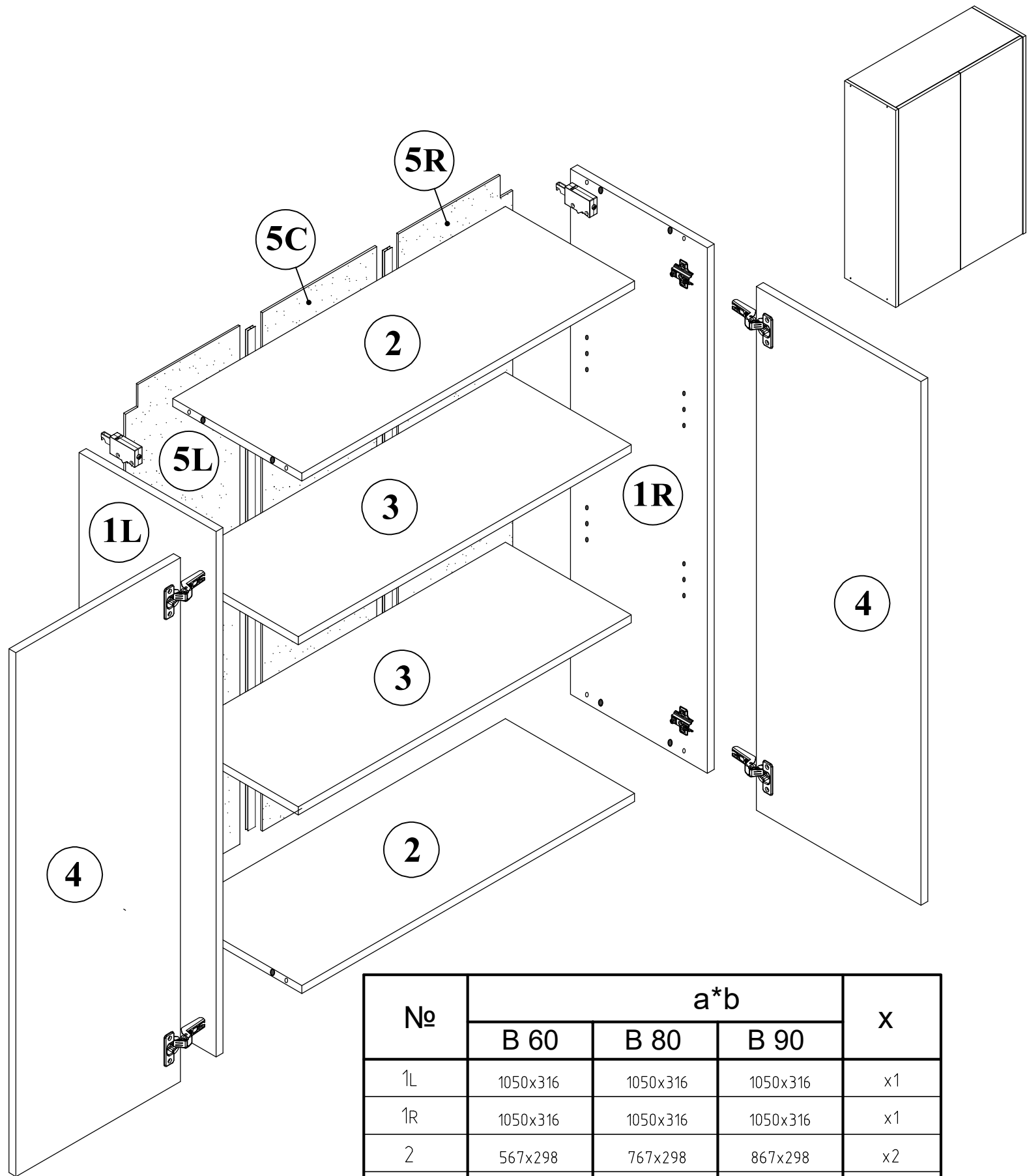

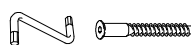
№	a*b			x
	B 60	B 80	B 90	
1L	1050x316	1050x316	1050x316	x1
1R	1050x316	1050x316	1050x316	x1
2	567x298	767x298	867x298	x2
3	566x290	766x290	866x290	x2
4	1047x280	1047x380	1047x430	x2
5L	1036x297	1036x264	1036x297	x1
5R	1036x297	1036x264	1036x297	x1
5C	—	1036x264	1036x297	x1
				x1

