



INTELLIGENCE INVERTER SPLIT HEAT PUMP INSTALLATION MANUAL



MODEL: ISW-10, 15, 18, 24, 32 SF1-DN1 outdoors

ISW-10, 15, 18, 24, 32 SF1-SPM indoors

Dear user:

Thank you for using our products!

You are using an air source heat pump unit. There are certain requirements for the installation, use and maintenance of the unit. Properly installed, used, and maintained, your hot water unit will have a reduced failure rate and a significant increase in service life.

At the same time, correct installation, use, and maintenance will reduce the failure rate of your hot water unit and increase its service life.

If not in use for a long time in winter, be sure to empty the water in the system to avoid freezing crack.

We are always committed to technical improvement, Our company reserves the right to modify this technical manual without prior notice.

Please keep it well for further reference.

If there are mistakes and omissions, please criticize and correct them.

CONTENT

I OVERVIEW	- 4 -
1.1 TYPE & MODEL	- 4 -
1.2 COMPONENTS	- 4 -
1.3 SCHEMATIC DIAGRAM OF SYSTEMS	- 5 -
1.4 COOLING OPERATION	- 5 -
1.5 HEATING OPERATION	- 6 -
1.6 DEFROST OPERATION	- 6 -
1.7 PERFORMANCE PARAMETERS	- 6 -
1.8 ENVIRONMENTAL REQUIREMENTS	- 8 -
II INSTALLATION	- 9 -
2.1 TRANSPORTATION & HANDLING	- 9 -
2.2 UNPACKING	- 11 -
2.3 INSPECTION	- 11 -
2.4 SAFETY RULES	- 11 -
2.5 SAFETY PRECAUTIONS	- 11 -
2.6 SELECTION OF INSTALLATION SITES	- 12 -
2.7 THE ARRANGEMENT SPACING OF THE UNITS	- 13 -
2.8 SYSTEM INSTALLATION LAYOUT	- 14 -
2.9 MINIMUM CAPACITY OF THE WATER SYSTEM	- 19 -
2.10 UNIT INSTALLATION	- 22 -
2.11 MAINTENANCE SPACE REQUIREMENTS	- 23 -
2.12 INSTALLATION STEPS	- 23 -
2.13 INSTALL UNIT PIPE	- 23 -
2.14 INSPECTION ITEMS AFTER MECHANICAL INSTALLATION IS COMPLETED	- 23 -
III ELECTRICAL INSTALLATION	- 24 -
3.1 TASK INTRODUCTION AND PRECAUTIONS	- 24 -
3.2 POWER SOURCE	- 24 -
3.3 UNIT WIRING REQUIREMENTS	- 28 -
3.4 PAY ATTENTION TO INSTALLATION INSPECTION	- 28 -
IV SYSTEM TRIAL OPERATION	- 30 -
4.1 PRECAUTIONS BEFORE TRIAL OPERATION	- 30 -
4.2 INSPECTION ITEMS AFTER INSTALLATION	- 30 -
4.3 TRIAL OPERATION	- 31 -
V CONTROLLER OPERATION INSTRUCTIONS	- 32 -
5.1 OVER VIEW	- 32 -
5.2 THE BASIC MODEL OF SYSTEM BLOCK DIAGRAM CONTROL	- 32 -
5.3 REMOTE CONTROLLER	- 32 -
5.4 FAULT CODE/ SYSTEM PROTECTION	- 46 -
5.5. WIFI CONTROL FUNCTION	- 52 -
VI SYSTEM OPERATION AND MAINTENANCE	- 57 -
6.1 SYSTEM DIAGNOSTIC TEST	- 57 -
6.2 CREAMING SYSTEM	- 58 -
VI FAULT DIAGNOSE AND TREATMENT	- 60 -

I OVERVIEW

This Part mainly introduces the classification and model, naming rules, main components, working principle, transportation and storage environment requirements of air source heat pump heating and cooling units (hereinafter referred to as "units").

1.1 TYPE & MODEL

This series is including two types –Low temperature heating units & Low temperature heating and cooling units

1.2 COMPONENTS

The unit includes compressors, finned tube heat exchangers, fans, controllers, expansion valves, plate heat exchangers, etc.

1.2.1 COMPRESSOR

Using high-efficiency scroll compressors, some models of it with EVI function; low vibration, low noise and high reliability.

1.2.2 FINNED TUBE HEAT EXCHANGERS

Using finned tube heat exchanger with high heat dissipation efficiency. Design and verification of the distributor for specific models to ensure uniformity of refrigerant distribution in each circuit, greatly improving the utilization of heat exchangers.

1.2.3 PLATE HEAT EXCHANGER

Using brazed plate heat exchanger, which has characteristics of compact structure and high heat exchange efficiency.

1.2.4 WATER FLOW SWITCH

Using brand-name products, which with high reliability, and can effectively protect the unit.

1.3 SCHEMATIC DIAGRAM OF SYSTEMS

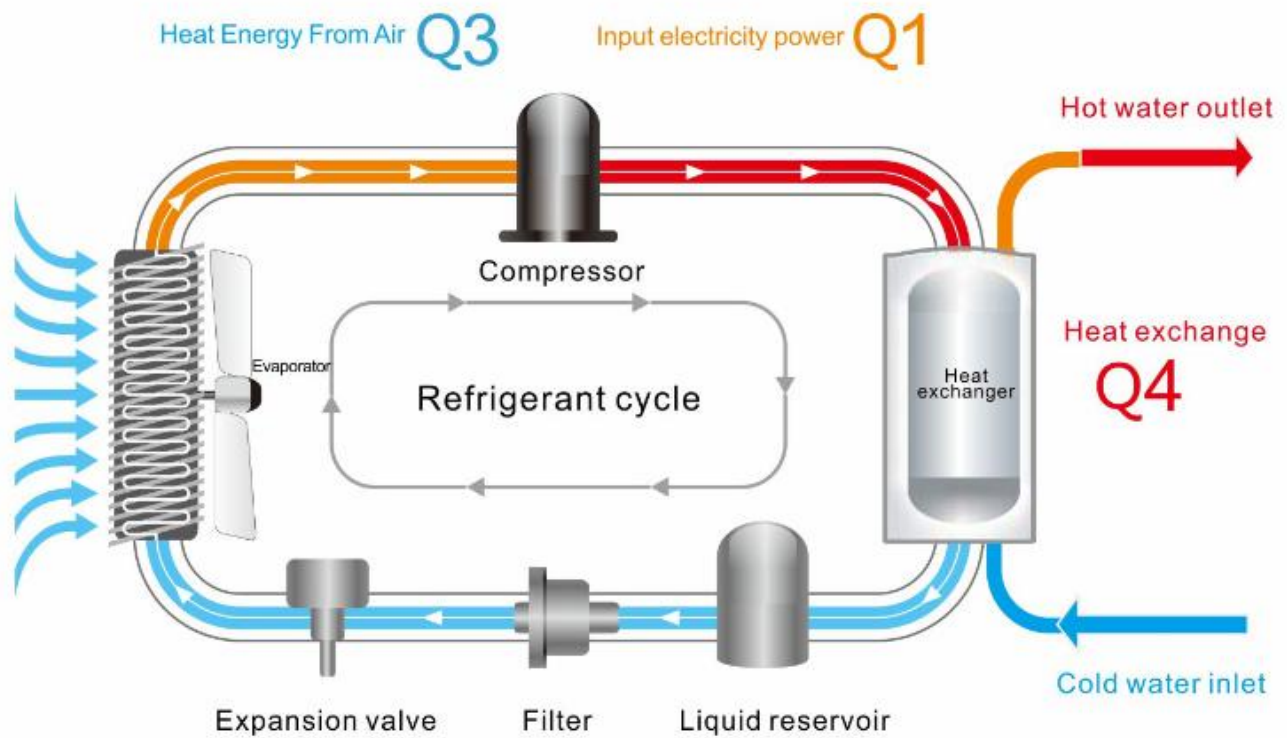

Figure 1-1

1.4 COOLING OPERATION

1. After compression by the compressor, the low-temperature low-pressure gaseous refrigerant becomes a high-temperature high-pressure gaseous refrigerant. After being discharged from the compressor exhaust pipe, it enters the condenser (air-side heat exchanger) through the four-way reversing valve. As the fan operates, the heat is carried away so that the refrigerant is condensed and becomes a liquid refrigerant.
2. The high pressure liquid refrigerant that has been condensed by the condenser enters the expansion valve. The liquid refrigerant expands in volume after throttling, and the state changes to become a low-temperature, low-pressure liquid refrigerant and a part of the gaseous refrigerant.
3. The gas-liquid mixture of the refrigerant flows into the evaporator (water-side heat exchanger) through the pipeline, and the refrigerant expands and evaporates in the heat exchanger, absorbs heat in the water, evaporates and absorbs heat to become gaseous, and the temperature of the brine becomes low. The pump is continuously operate, and the cooling capacity is continuously pumped to the end equipment, and then the cooling capacity is emitted.
4. Finally, the gaseous refrigerant that has been expanded and evaporated passes through the four-way reversing valve and the compressor suction line to enter the compressor then compress again and the cycle is repeated.

1.5 HEATING OPERATION

1. The working fluid, in its gaseous state, is pressurized and circulated through the system by a compressor, and then go into the heat exchanger through the fore-way reversing valve. The unit to release heat though the water, and the refrigerant is condensed into a high pressure liquid.
2. The high pressure liquid refrigerant that has been condensed by the condenser enters the expansion valve. The liquid refrigerant expands and changes state after throttling, and becomes a low-temperature, low-pressure liquid refrigerant and a part of the gaseous refrigerant.
3. After passing through the pipeline, the liquid refrigerant evaporates and absorbs the heat of the air in the air-side heat exchanger to become a gaseous refrigerant.
4. Finally, the gaseous refrigerant enters the compressor through the four-way reversing valve and the compressor suction line then compress again and the cycle is repeated.

1.6 DEFROST OPERATION

1. When the unit is running in the heating mode in a low ambient temperature, the air side heat exchanger may frost, which will affect the heating effect, so defrosting is required.
2. The defrost controller performs long-term monitoring by combining the air side coil temperature and the timer to determine whether defrosting is required.
3. The unit changes the heating operation to the cooling operation through the four-way reversing valve. At this moment, the high-temperature and high-pressure gaseous refrigerant is defrost through the air side heat exchanger. The fan does not operate during the defrost time of the compressor.
4. After the defrosting is completed, the cooling operation is resumed to the normal state - heating operation by switching the four-way switching valve.

1.7 PERFORMANCE PARAMETERS

FULL DC INVERTER SPIIT HEAT PUMP						
MODEL		ISW-10 SF1-DN1/ SPMI	ISW-15 SF1-DRN1 /SPM	ISW-18 SF1-DRN1/ SPM	ISW-24 SF1-DRN1/SPM	ISW-32 SF1-DRN1/ SPM
Working Temperature Range		-25~43℃				
Power Supply		220-240V/5 0Hz/1N	380-415V/50Hz/3N			
A7W35	Heating capacity (min-max) (kW)	10(3-11)	16(4-17)	18(4-20)	24(5-27)	32(5-35)
	Input power (kW)	2.30	4.0	4.45	6.00	8.00
	Rated current (A)	10.50	7.5	9.00	10.00	12.00
	COP	4.00	4.0	4.04	4.00	4.00

A2W45	Heating capacity(min-max) (kW)	7.8(3-8)	12.2(5-13)	15(4-16)	19(5-20)	25(5-27)
	Heating input power(kW)	2.32	3.60	4.65	6.80	7.70
	Rated current (A)	11.00	7.8	9.2	9.8	12.00
	COP	3.36	3.39	3.23	3.28	3.25
A35W7	Cooling Capacity/EER (kW)	7/2.81	11/2.8	14/2.75	19/2.7	25/2.75
	Rated Cooling Input Power/Current(kW/A)	2.5/11.3	3.93/8	5.0/9.5	7.0/10.0	9.1/14
Heating Outlet hot water temperature range (°C)		25-55				
Cooling Outlet water temperature range (°C)		7-12				
IP Grade (Level of protection)		IPX4				
Anti-electric shock Rate		I				
Noise (dB(A))		≤55	≤60	≤60	≤70	≤70
Net weight/Gross weight(kg)		96/106	127/137	142/156	220/232	263/275
Diameter of water connector (mm)		DN25	DN25	DN32	DN32	DN32
Cabinet material plate		Galvanized steel/Spray/Gray				
Machine size	Outdoor unit (W*D*H)	880*420*790mm	930*410*1270mm	1018*450*1366mm	1155*540*1432mm	1240*540*1630mm
	Indoor unit (W*D*H)	380*330*685mm	380*330*685mm	450*330*815	550*420*920	550*420*920
Compressor		Panasonic Rotary EVI DC inverter / Mitsubishi Inverter				
Refrigerant/Weight (Kg)		R410a/1.9	R410a/ 2.5	R410a/ 2.8	R410a/ 3.8	R410a/ 5.2
Controller		7m Wired controller touch screen display				
Copper pipe Diameter High/Low (inch) Optional		3/8"/5/8"	3/8"/5/8"		1/2"/3/4"	1/2"/3/4"
Expansion valve		Sanhua				
Low-voltage switch		0.15/0.05MPa			0.15/0.05MPa	
High-voltage switch		3.6/4.2MPa			3.6/4.2MPa	
Package		Carton packing				

1.8 ENVIRONMENTAL REQUIREMENTS

1.8.1 OPERATING ENVIRONMENT

The operating environment requirements of the unit are shown in Table 1-1.

ITEM	REQUIREMENT
INSTALLATION LOCATION	Installation method: horizontal installation
AMBIENT TEMPERATURE	Outdoor: -25 °C ~ +43 °C
ENVIRONMENT HUMIDITY	Outdoor: 5%RH~95%RH
RUNNING POWER	220V±10%/1N~/50Hz; 380V±10%/3N~/50Hz;
ALTITUDE	Not more than 1000m. Need to reduce the rated power when more than 1000m.
WATER PROOF RATING	IPX4

1.8.2 STORAGE ENVIRONMENT

The storage environment requirements of the unit are shown in Table 1-2.

ITEM	REQUIREMENT
STORAGE ENVIRONMENT	Indoor, clean place (no dust, etc)
ENVIRONMENT HUMIDITY	5%~85% (no condensation)
AMBIENT TEMPERATURE	-30 °C~+54 °C

1.8.3 ANTIFREEZE WARNING

When the ambient temperature of the unit is lower than 0 °C, please ensure that the unit is in the power supply state, if the antifreeze is not used as the cold carrier (heat) agent; If it cannot be ensured, please drain the water in the unit, otherwise the unit will have the risk of cracking. Each unit is equipped with drain valves at the lowest part of the unit's waterway.

II INSTALLATION

This Part describes the mechanical installation of the unit, including transportation, unpacking inspection, installation layout, and installation procedures, etc.

EQUIPMENT HANDLING, UNPACKING, INSPECTION

2.1 TRANSPORTATION & HANDLING

Choose a road with better conditions to prevent excessive bumps when transporting.

The tilt angle of the unit should be kept within the range of $75^{\circ} \sim 105^{\circ}$ when transporting. (Figure 2-1)

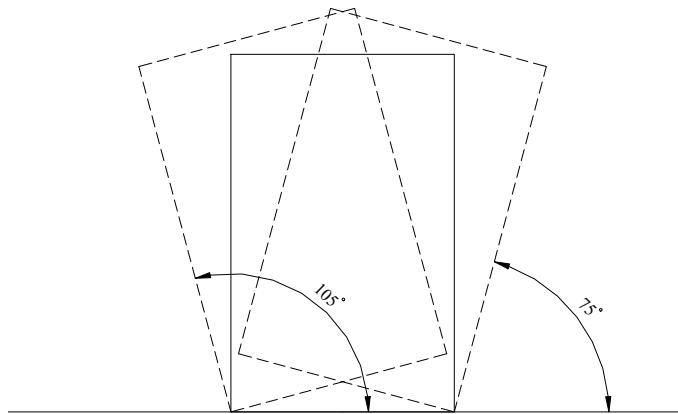

Figure 2- 1 The tilt angle of the unit

Please use a forklift to carry it. If there is no forklift, please move it with the help of the cylinder-shaped things like crabstick.

Rolling transport: 6 piles with same size are placed under the base of the unit. Each roller must be a little longer than the base frame and suitable for the balance of the unit. (Figure 2-2)

Á

Lifting & installation: (Figure 2-3) The strength of the lifting cable should be 3 times larger than the weight of the unit. Check and ensure that the lifting hook is fastened to the unit, and the lifting angle should be greater than 60°.



Á

Figure 2- 3 Lifting of the unit

□ **NOTE:**

Do not stand under the unit when lifting.

Add fabric between the unit and the cable to prevent damage to the unit.

2.2 UNPACKING

Try to move the heat pump to the nearest place to the installation site, and then remove the packaging.

Unpacking steps:

1. Remove the side and top panels of cardboard.
2. Remove the packaging.
3. Remove the wood pallet.

2.3 INSPECTION

When receiving the goods of the company, please check that the delivery is complete and undamaged, and whether the quantity of accessories are correct and all of the accessories are undamaged. If any parts are missing or damaged during the inspection, please report to the carrier immediately. And if you find hidden damage, please report it to the local office of the carrier and product supplier.

2.4 SAFETY RULES

In order to achieve the design performance of the unit and maximize its service life, please strictly follow the installation instructions. This section should be applied in conjunction with current unit and electrical installation regulations.

The unit is installed in an integrated floor plan, please install it outdoors or on the roof of the building.

Before installing the equipment, confirm that the installation environment meets the requirements (as showed 1.8.2). And confirm the whether the building should be modified to match the construction of the pipeline, wiring and the ventilation ducts.

The installation must strictly follow the design drawings and reserve maintenance space. Refer to the engineering dimensional drawings provided by the manufacturer.

2.5 SAFETY PRECAUTIONS

- Please entrust professionals with professional knowledge to install. If it is installed incorrectly, it may cause fire, electric shock, injury, water leakage, etc.
- According to the law, reliable grounding work must be carried out. If the grounding work is not inadequate, it may cause electric shock.
- Do not put fingers, sticks, etc. into the motor fan. High-speed operation of the internal fan of the unit may result in damage to the unit or personal injury.
- When there is abnormality (such as burnt smell), should immediately turn off the manual power switch, stop the operation, and contact with the dealer. If continue to operate, it may cause electric shock or fire.
- When the unit needs to be moved or reinstalled, please ask professionals to operate. If the installation is not perfect, it may cause electric shock, fire, injury, water leakage, etc.
- DO NOT modify or repair the unit by user, otherwise it may cause electric shock or fire.
- When need repair the unit, please entrust professionals. if repaired improperly, it may cause fire, electric shock, injury, water leakage, etc.

- Confirm that the leakage protection switch is installed. The leakage protection switch must be installed, otherwise it may cause electric shock.
- Connect the cable correctly. If the cable is connected incorrectly, electrical parts may be damaged.
- DO NOT operate the unit near flammable materials (such as paint, paint, gasoline, chemical reagents, etc.) to prevent fire or explosion. If cause fire, should turn off the main power immediately and extinguish the fire with fire extinguishers.
- Regularly check and make sure that the erecting platform is secure and intact.
If the erecting platform is damaged and not strong, the unit may fall and cause casualties.
- When cleaning the unit, should cut off the manual power switch. If not, it may cause damage to the unit or personal injury.
- Do not touch the refrigerant exhaust parts by hand to prevent burns.
- Please use the corresponding fuse. It can not be replaced by copper wire or iron wire. Otherwise, the unit will be seriously damaged or fire.
- Do not spray flammable spray onto the unit, otherwise it may cause fire.

2.6 SELECTION OF INSTALLATION SITES

1. This outdoor unit is designed to be located outdoors with sufficient clearance for free entrance to the inlet and discharge air openings. The location must also allow for adequate service access.
2. The installation position of the unit should avoid the boiler flue or other air environment that will corrode the condensing coil and the metal parts of the unit.
3. If the unit is located in a location accessible to unauthorized personnel, isolation safety measures such as guardrails should be taken. This will prevent sabotage and accidental damage.
4. The bearing surface of erecting platform of the unit should be flat, can withstand the weight of the unit, can install the unit horizontally, and will not increase noise and vibration.
5. The operating noise and exhaust air of the unit should not affect neighbors.
6. There is no flammable gas leakage in the installation place of the unit.
7. Easy to carry out pipelines and electrical connections.
8. For occasions with special installation requirements, please consult the building contractor or architect or other professional.

□ **NOTE:** Installation in the following locations may cause machine malfunction (if it cannot be avoided, please consult)

- In places where there is mineral oil such as cutting machine oil.
 - In places where there is more salt in the air such as on the coast on the coast.
 - In places where there are corrosive gases like sulfur gas in areas with hot spring.
 - In places where the power supply voltage fluctuates severely.
 - Outside the car or cabin.
 - In places where is filled with oil such as in the kitchen .
 - In places where there is a strong electromagnetic wave.
 - In places where there are flammable gases or materials are present.
 - In places where there is volatile acid gas or volatile alkaline gas.
 - Other special environmental conditions.
-

2.7 THE ARRANGEMENT SPACING OF THE UNITS

Recommended installation spacing diagram for outdoor unit (unit: mm)

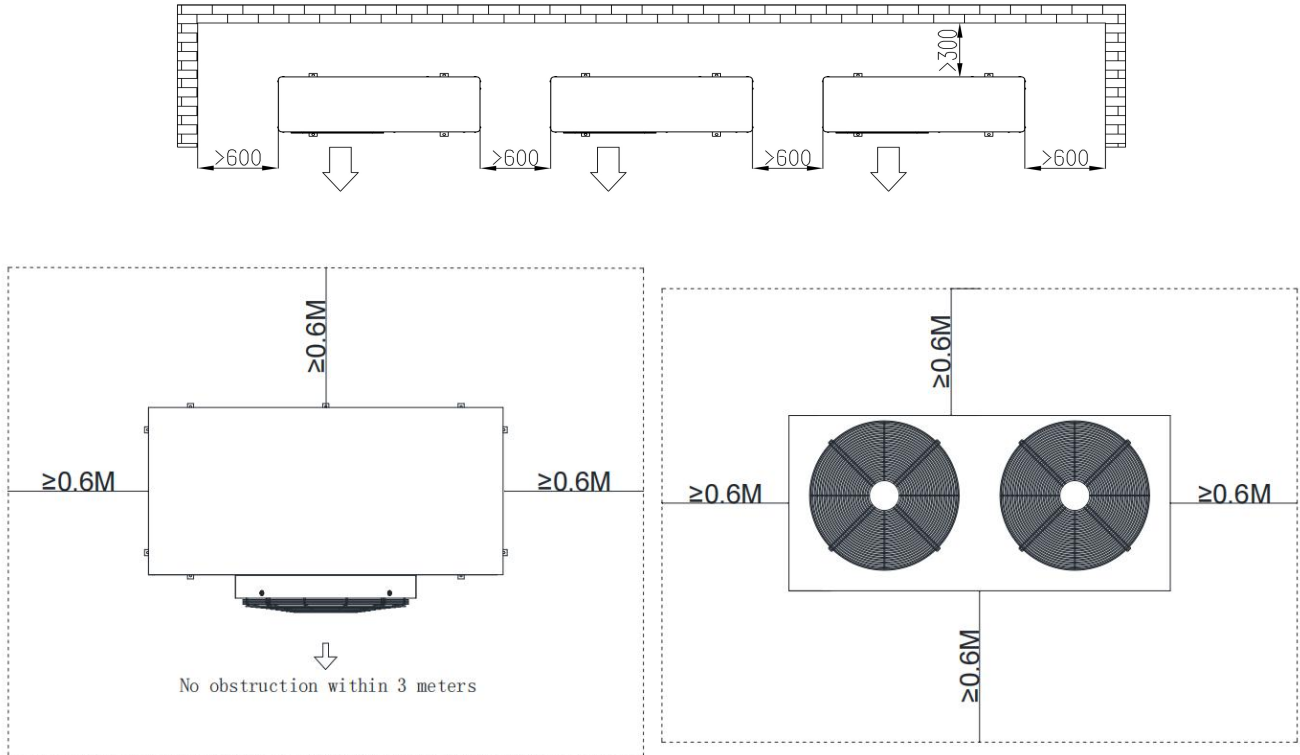

Figure 2- 4 Recommended installation spacing diagram for unit installation

□ **NOTE:**

- Required service & water pipes connection space when installing the unit.
- If there are obstacles in front of the air outlet of the unit, please make sure that the obstacles are more than 2000 mm from the air outlet.
- If there are sundries around the unit, please make sure that the sundries are more than 400 mm from the blow of the unit.
- The unit should not be installed in basements, indoors or other confined spaces. If the project requires the unit to be installed in such spaces, please consult with our company or the designated supplier.

2.8 SYSTEM INSTALLATION LAYOUT

2.8.1 OVERALL LAYOUT OF THE HYDRAULIC SYSTEM

For hot water and floor heating is shown in the figure below.

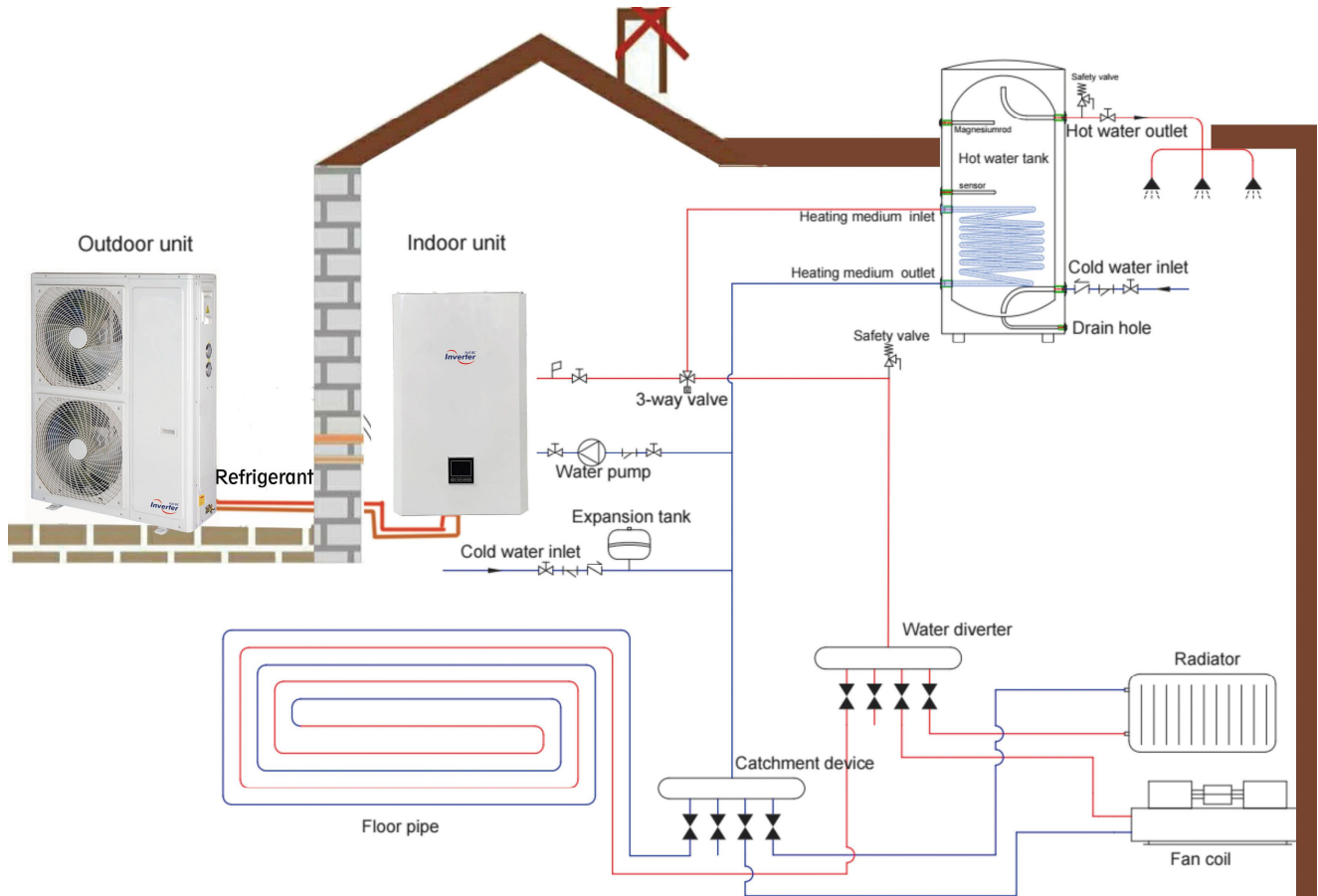

For heating/cooling is shown in the figure below

2.8.2 INDOOR UNIT AND OUTDOOR UNIT CONNECTION PIPE CONNECTION

1, Use the connection pipe to connect outdoor unit and indoor unit together. (Optional see pic1)



(Pic 1)

2. Remove the head nut of stop valve from the indoor unit and the outdoor unit .(see pic2, 3)



(pic2, 3)

3. Drip a few frozen oil onto the copper nut of the connecting pipe and screw it to the stop valve's joint of the indoor unit and the outdoor unit and tighten with a wrench . The tightening torque of the copper pipe bolt is about 10kg·m.(see pic4、 5)

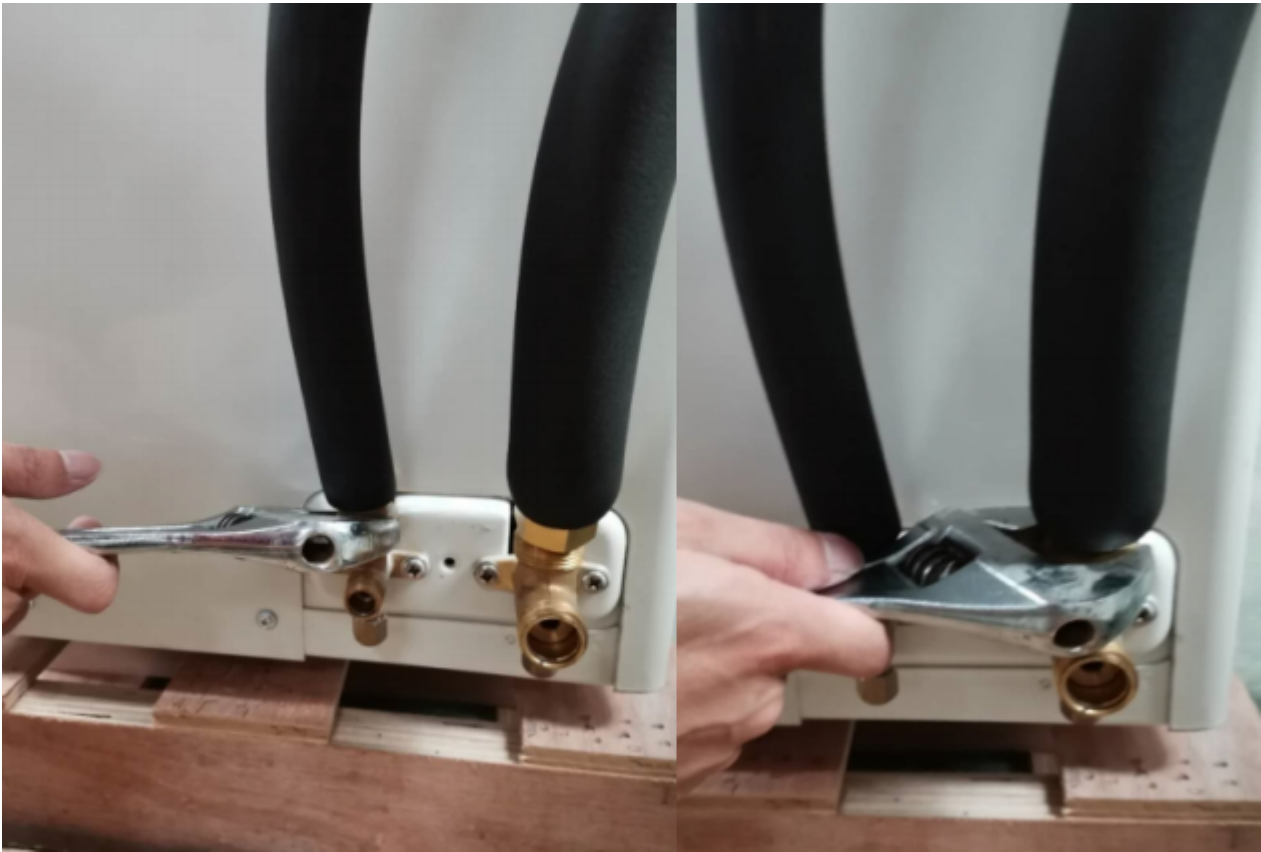

(pic4、 5)

4.

Leakage detecting: Use a wrench to remove the head nut of needle valve from the outdoor unit's stop- 18 - valve.



(pic 6)

5, Same operation to connect with the indoor units. After the leakage detecting and vacuuming are completed, then open the stop valve of the indoor unit (See Pic7,8). It is necessary to use the hexagonal counterclockwise to

completely open the stop valve of indoor unit before starting the operation.



(Pic 7, 8)

6, Vacuumize:

(1), Equipment: vacuum pump, pressure gauge, Allen wrench

(2), Discharge the refrigerant added to the connecting pipe when doing leakage detecting.

(3), Use a hexagon socket to completely unscrew the outdoor unit's stop valve counterclockwise, draw a vacuum from the needle valve of the outdoor unit's stop valve. (Pic 9)



(Pic 9)

7, To ensure that the vacuum is

acceptable, the pumping time cannot be less than 20 minutes.

(Pic10,11), Or the pressure value of the pressure gauge is lower than -0.1MPa.



(Pic10,11)

8, After the vacuum is acceptable, open the stop valve of the outdoor unit (See Pic12,12). It is necessary to use the hexagonal counterclockwise to completely open the stop valve of indoor and outdoor unit before starting the operation. Let the refrigerant go through the whole system.

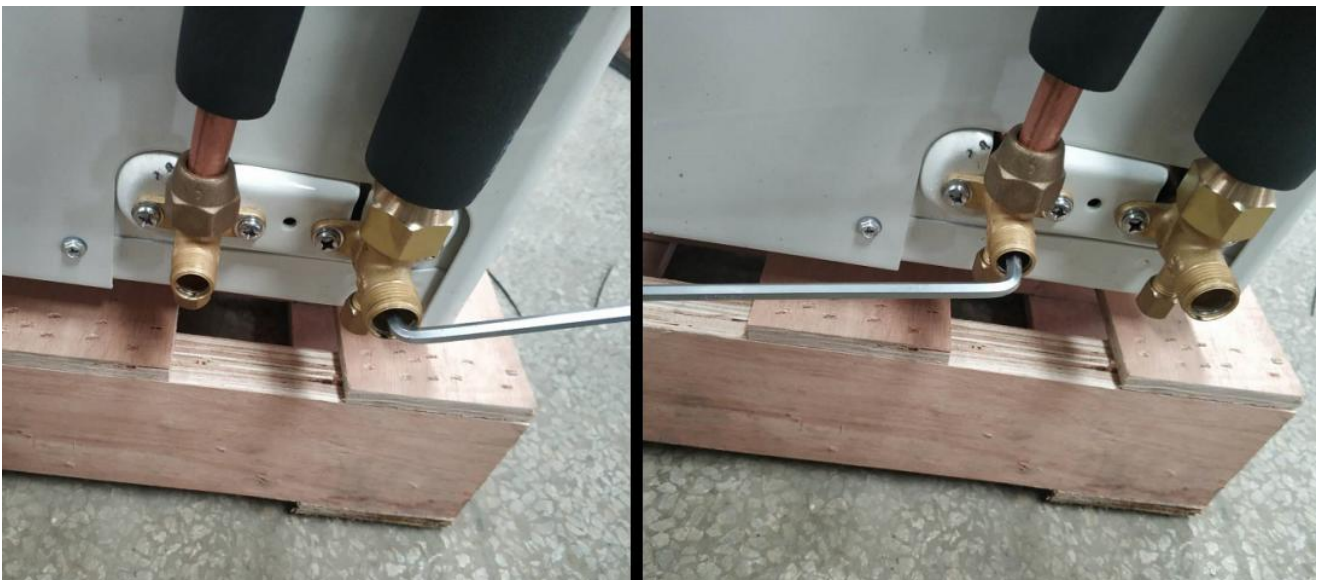

(Pic12,13)

Note: For installation related to the water pipe part:

- ● Install a valve at the highest point of each water circulations for releasing air from water system.
- ● A Y-shape filter is very important in front of circulating water pump of heat pump.
- ● If more pieces heat pump installed in one water pipe system, the connection of these heat pumps can't be in series, only can be in parallel or independent.
- Pre-start up

Checking before pre-start up

- ● Check if the water pipe are connected well and if there is any leakage. The water supply valve are open.
- ● Make sure the water flow is enough and meet the demand of the heat pump selected and water flow smoothly without air . In cold area, pls make sure that the water flow is without freezing
- ● Check if the power cable is connected well and properly grounded.
- ● Check if fan blade is blocked by the fixing plate of fan blade and fan blade protecting grill.

-
- ● Check if the tank has been filled with water or enough water volume that can meet the demand of heat pump running

-
- If everything above is ok, the unit can start up , if any of them fails, please improve it

Pre-start up

- ● After check completely and confirm no problem for installation, the unit can be power to start up .
 - ● After connect power supply, heat pump delay 3mins to start. Check carefully is there is some abnormal noise or vibration or if the working current is normal or if water temp increasing is normal.
 - ● After the unit is working properly for 10 minutes without any problem, then the pre-start up is usefully completed. If not, please refer to Service and Maintenance Chapter to solve the problem.
-

2.9 MINIMUM CAPACITY OF THE WATER SYSTEM

For the household air conditioning water system, in order to obtain good thermal stability, the air conditioning load should be accurately determined first, and the host with matching installed capacity should be selected; Secondly, the greater the water capacity of the system, the greater the system cooling capacity, the better the thermal stability of the system. Conversely, the thermal stability of the system is worse. Therefore, when designing the water system, it should be checked whether the water capacity of the calculation system meets the thermal stability requirements of the system. When the actual water capacity of the system cannot meet the requirements, the system main pipe diameter or a new water storage tank should be increased. The system minimum water capacity can refer to the following recommended values:

Recommended minimum volume table for water system

Model	Recommended minimum volume(L)
XD-03BSPM	40-60
XD-05,06BSPM	60-80

Figure 2-6

Because the floor heating capacity of the floor heating system is large, the system temperature stability is greatly guaranteed, and this point can be ignored.

For commercial water system design, it should be checked whether the water capacity of the calculation system meets the thermal stability requirements of the system. When the actual water capacity of the system cannot meet the requirements, the main pipe diameter of the system or a new water storage tank should be added. It is not means that the greater the water capacity of the system, the better the water capacity is. The water capacity is too large, and its thermal stability is undoubtedly good. However, after a long time of shutdown, time for pre-cooled or warm-up of the air conditioner will be extend.

The water capacity of the system can be calculated as follows:

$$V = P \times T / (C \times \Delta t)$$

V: system minimum (large) water capacity, kg (unit), 1 kg =1 L.

P: the heat dissipation power of the terminal of the unit, it can be calculated according to the rated cooling capacity of the host, W(unit).

T: Minimum (large) requirement for stability, S (unit);

C: Specific heat of water, 4200J/kg·°C;

Δt: The fluctuation of water temperature requirements, it can be referenced by 5K.

2.9 MECHANICAL PARAMETER

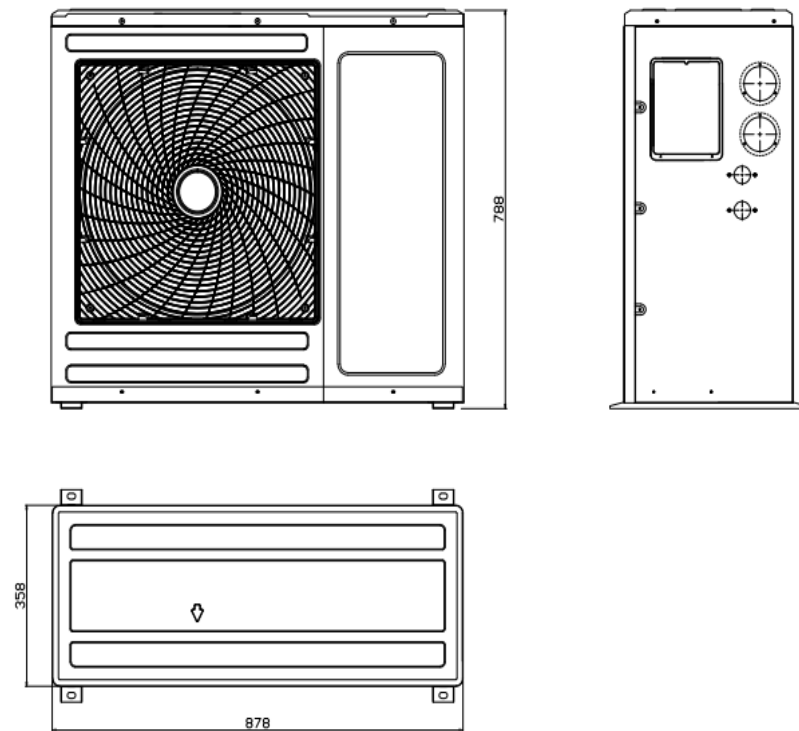

XD-03BSPM

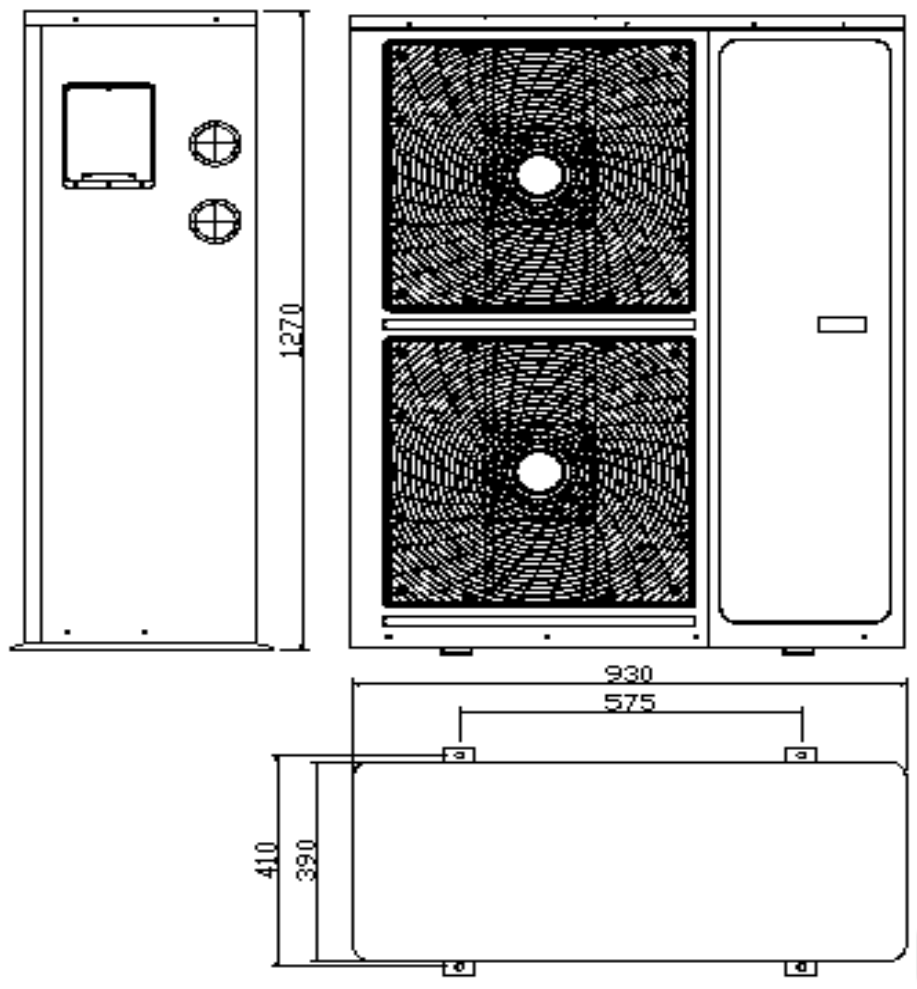

XD-05BSPM

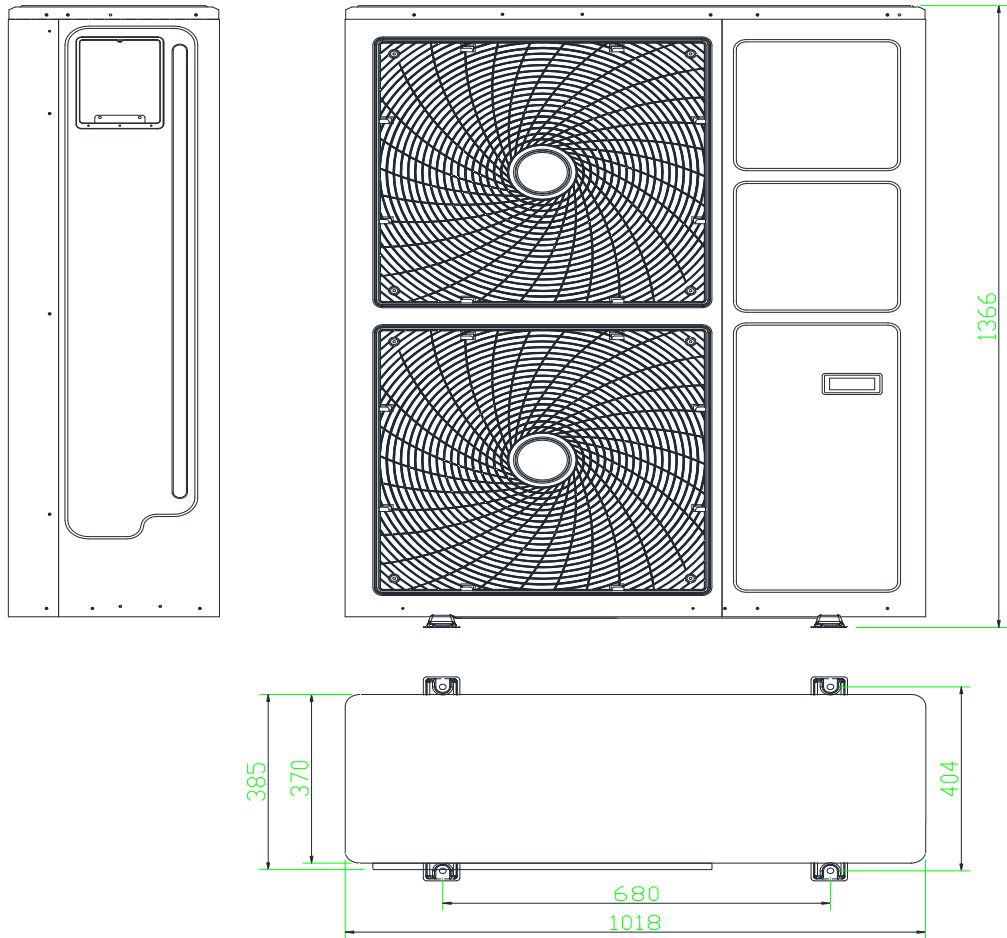

XD-06BSPM

Figure 2-8 Unit (mm)

2.10 UNIT INSTALLATION

2.10.1 INSTALLATION SPACE

Note

As the unit will produce condensate, water leakage may will cause damage to other equipment nearby. So, drainage pipe must be provided during installation.

1. To ensure the normal operation of the unit, try to choose a spacious space as the installation site of the unit;

2. Avoid placing multiple outdoor units close together to avoid cross-air flow, unbalanced loads, and competitive operation;

3. When installing on the top of the building, pay attention to protecting the waterproof layer and complying with relevant local regulations.

2.11 MAINTENANCE SPACE REQUIREMENTS

1. There is no obstruction within 2m of the air outlet of the unit.

2. Both sides of the unit need to ensure a maintenance space of more than 600mm.

2.12 INSTALLATION STEPS

The installation steps of the outdoor unit are as follows:

1. Make the mounting base according to the requirements of the outline drawing. The mounting base can be made by the user.

2. Determine the installation position, and fix the installation base to the selected installation position according to the site conditions and user requirements.

3. Use nuts, spring washers, flat washers and bolts to fix the unit on the mounting base.

4. During installation, it can be slightly inclined to the drainage side to facilitate drainage.

5. Install on a firm foundation.

2.13 INSTALL UNIT PIPE

1. Please refer to the water system layout drawing for connecting the unit's water system pipeline.

2.14 INSPECTION ITEMS AFTER MECHANICAL INSTALLATION IS COMPLETED

1. Leave some space around the equipment for easy maintenance;

2. The unit is placed horizontally and the installed fastening parts are locked;

3. The pipelines connected to the unit have been installed and all valves have been fully opened;

4. The drain pipe is connected;

5. All pipe joints have been tightened;

6. After the installation of the equipment is completed, the debris inside or around the equipment has been removed (such as transportation materials, structural materials, tools, etc.);

After all the contents have been checked and confirmed, please perform the electrical installation operation.

III ELECTRICAL INSTALLATION

This chapter introduces the electrical installation of the unit, including tasks, installation precautions, connecting power cords, and installation inspections.

3.1 TASK INTRODUCTION AND PRECAUTIONS

3.1.1 LINES TO BE CONNECTED AT THE INSTALLATION SITE:

1. Power cable
2. Out put control line

3.1.2 INSTALLATION PRECAUTIONS

- The unit should use a dedicated power supply, and the power supply voltage and frequency meet the rated specifications.
- The power supply circuit of the unit must have a ground wire. The power ground wire must be reliably connected to the external ground wire, and the external ground wire is effective.
- Wiring construction must be performed by professional technicians according to the electrical control wiring diagram.
- The wiring work must meet the requirements of the relevant national technical standards for electrical equipment, and leakage protection devices must be installed.
- The power cord and signal wires should be arranged neatly and reasonably, and they should not interfere with each other, and they should not contact the connecting pipe or valve.
- After all wiring is completed, carefully check and confirm that it is correct before turning on the power.

The lines that need to be installed and connected at the site include external power cords, controller wires, and unit connection wires. After the unit is installed, you can connect the power cord and connecting wire. All wires must be firmly connected and must not contact any moving parts. All wires must meet national or relevant manual standards. The unit requires grounding measures. All electrical equipment and its installation must meet the requirements of national and local safety regulations.

Note: The wiring of the communication cable between the remote controller and the main control board should follow the principle of separate strong wires and weak wires, and avoid power lines and other sources of strong power interference. Do not bundle with power line. The installation should not be too close to the TV, audio and other equipment, so as to avoid interference and affect operation. Separate the strong and weak wires by at least 30cm.

3.2 POWER SOURCE

The input line of the unit is recommended to be no smaller than the copper core wire listed in the table below.

Figure 3-1

Model	ISW-10SF1	ISW-15SF1	ISW-18SF1	ISW-24SF1	ISW-32SF1
Power source	220V/1N~/50Hz	380V/3N~/50Hz			
Main switch capacity/leakage protection device/fuse(A)	15	15	20	20	20
Power cord size (mm ²)	4	4	6	6	6
Ground wire size(mm ²)	2.5	2.5	4	4	4

There are total 3 connecting cables between indoor and outdoor machines, including the Water pump connecting wire (220V/50Hz, 7m can be connected), the wire controller line (4-core, 10 meters can be connected), and the temperature probe connecting line (6-core, 7 meters can be connected). The pictures are as follows.



The three kinds of wires are in 1-1 mapping relationship with the connecting terminals. The connecting methods are as follows

1. Connect the circulate water pump wire to the wiring terminals(1 or 2) of the outdoor machine and the indoor machine, as shown in the figure below.

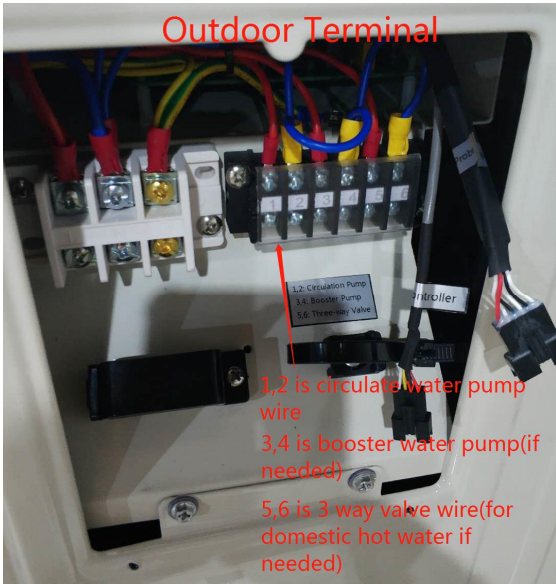

Outdoor Terminal



Indoor Terminal

2. Connect the controller wire to the wire controller wiring terminal of the outdoor machine and the indoor machine, as shown in the figure below:

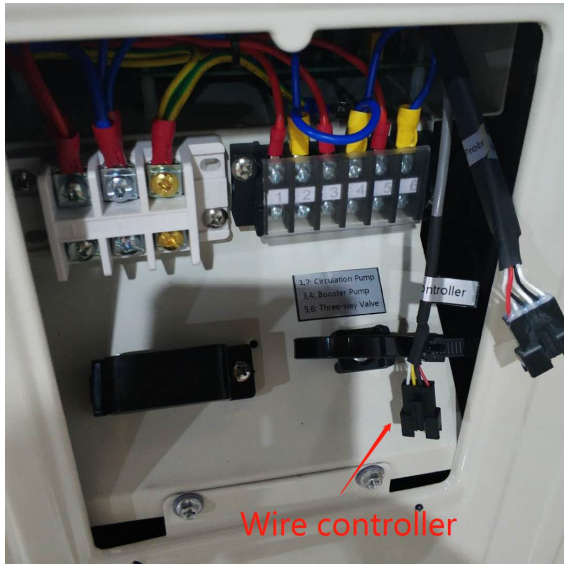

Outdoor



Indoor

3. Connect the the Temperature Probe to the Temperature Probe wiring terminal of the outdoor machine and the indoor machine, as shown in the figure below.



Outdoor



Indoor

4. After the above 3 cables are connected, connect the power cable to the outdoor machine terminal, as shown in the following figure.

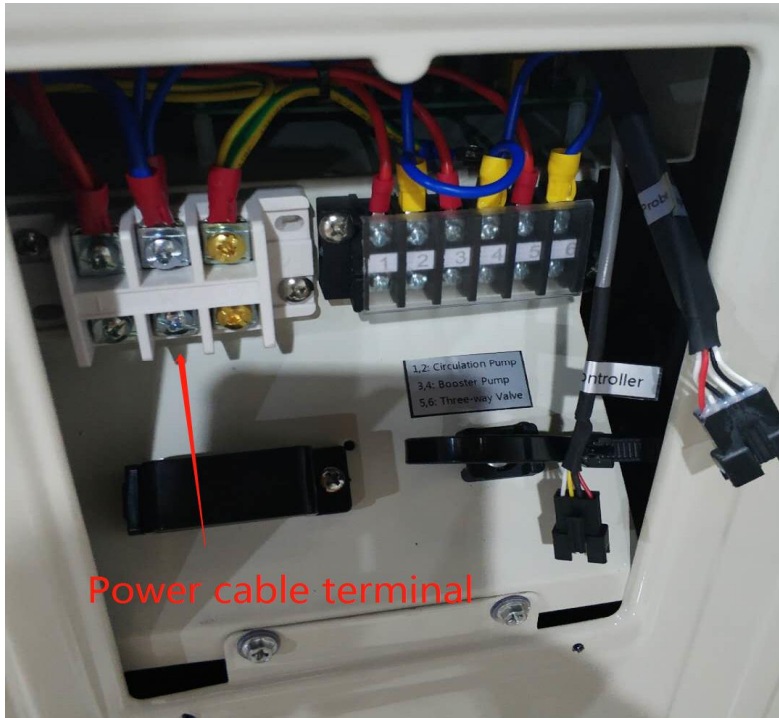

Outdoor

3.3 UNIT WIRING REQUIREMENTS

1. Power supply and control lines not connected to the electric control box are not allowed to pass through the electric control box. Otherwise, electromagnetic interference may cause the unit and control devices to malfunction or even be damaged, and will lose efficacy.
2. In the electric control box, there are generally strong current lines passing through, and the control board also has 220V AC power passing through. The principle of separation of strong and weak power should be followed when wiring. The operation panel connection cable cannot be bundled with the power cable.
3. All electrical circuits must comply with local wiring specifications. According to EU standards, users are responsible for providing voltage and current protection to the input power of the unit.
4. All the power connected to the unit must pass a manual switch, and ensure that when this switch is turned off, the voltage on the circuit node of the unit is all released.
5. must use the correct specification of the cable to provide power to the unit. The unit should use an independent power supply. It is strictly forbidden for the unit to share the same power source with other electrical appliances to avoid danger of overload. The fuse or manual switch of the power supply should match the working voltage and working current of the unit.
6. The unit must be installed with a ground wire. Do not connect the ground wire to the gas fuel pipe, water pipe, lightning conductor or telephone. Improper grounding may cause electric shock accidents. Please check the unit grounding frequently.
7. All the lines connected to the unit should avoid rainwater from penetrating into the unit to prevent leakage accidents.

3.4 PAY ATTENTION TO INSTALLATION INSPECTION

After the electrical installation is complete, check to confirm:

1. The power supply voltage and frequency are the same as the rated voltage and frequency on the equipment nameplate.
2. There is no open circuit or short circuit in the electrical circuit of the system.
3. The power cables and ground cables to the disconnect switch, the unit are connected.
4. All cables and circuit connectors have been tightened, and the fastening screws have not been loosened.

Note: The unit must be reliably grounded!

After all the above contents are checked and confirmed to be correct, you can start debugging.

IV SYSTEM TRIAL OPERATION

This chapter introduces the system trial operation, including the preparation work of the mechanical, water system, and electrical parts before start up.

4.1 PRECAUTIONS BEFORE TRIAL OPERATION

- Trial operation can only be performed after electrical safety inspection.
- Do not block the air inlet and outlet. Otherwise, the performance of the unit may be degraded or the protection device may be activated and fail to operate.
- Make sure that all valves are open, flushing and draining the water system pipes, and confirm that the water cleanliness meets the requirements.
- Fill the water system and empty it to ensure that there is no air in the water system.
- Never perform forced operation. (The protection device does not work, which may cause damage to the unit and lose efficacy!).
- Whether the system is fully warmed up (more than 12 hours).

4.2 INSPECTION ITEMS AFTER INSTALLATION

According to this manual, check the installation work by referring to the following table.

Figure 4-1 Inspection items

INSPECTION ITEMS	DETAILED DESCRIPTION	YES	NO
Whether the installation position meets the requirements	Unit is firmly installed and leveled		
	The air flow space of heat exchanger at air side meet the requirements		
	Maintenance space meets the requirements		
	Appearance meets the requirements		
Whether the water system meets the requirements	Water pipes' size meet the requirements		
	Pressure control meets the requirements		
	Insulation meets the requirements		
	There is no air in water system		
Whether the electrical system and wiring meets the requirements	Leakage protector is effective		
	Grounding wire is correct		
	Wires' capacity meet the requirements		
	Switches' capacity meet the requirements		
	Fuse capacity meets the requirements		
	Voltage and frequency meets the requirements		
	Tightened connection position		

	Safety devices meet the requirements		
	Connection of operation panel meets the requirements		

4.3 TRIAL OPERATION

Use the operation panel to control the unit operation, and check the following items according to the operating instructions:

1. Whether the operation panel switch is normal.
2. Whether the function keys on the operation panel are normal.
3. Whether the indicator light is normal.
4. Whether the drainage is normal.
5. Is the temperature difference between inlet and outlet water normal (4 ~ 7 °C)
6. Whether vibration and sound are normal during operation.
7. Does the wind, noise and condensate generated during operation affect the neighbors?
8. Whether there is refrigerant leakage.

Note: When restarting after shutdown, the unit is equipped with a protection function, and the compressor will start after a delay of 3 minutes.

V CONTROLLER OPERATION INSTRUCTIONS

5.1 OVER VIEW

◎ The chip is developed and designed for inverter heat pump, the main features are as follows:

There are heating and cooling operation modes;

The operating parameters and setting parameters of the system can be displayed and changed, which greatly facilitates user debugging and installation;

With automatic protection function and automatic fault alarm function, and can record and store recent faults;

With powerful system protection functions: compressor delay protection, high pressure, low pressure, sensor protection, water flow detection, etc.;

The communication distance between the host and the remote controller is not less than 100 meters; the communication port adopts 485 communication.

Strong anti-interference, stable and reliable performance;

5.2 THE BASIC MODEL OF SYSTEM BLOCK DIAGRAM CONTROL

◎ SYSTEM BLOCK DIAGRAM

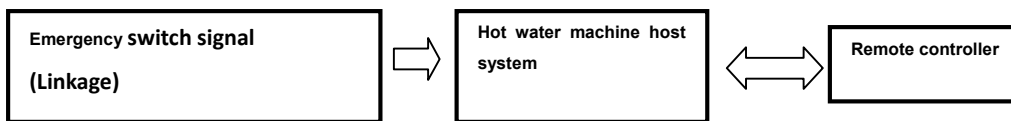

◎ Control principle

The outdoor host is connected to the command operation of the remote controller;

The remote controller can change the operating parameters, and can transmit the operating parameters to the outdoor host;

The outdoor host detects outdoor operating conditions and transmits operating information (fault information) to the remote controller;

5.3 REMOTE CONTROLLER

LED color screen wire controller (with plastic case):



Icon introduction:

1. Heating mode, display symbol "☀️"
2. Cooling mode, display symbol "❄️"
3. Display "▶️" when the pump is running
4. Display "⏸️" when the compress is running
5. When defrosting, "❄️💧" is displayed, indicating defrosting operation
6. When the fan is running, "🌀" is displayed, "1" under the fan logo represents low wind, and "2" represents high wind
7. When the Wi-Fi connection is successful, "📶" will be on, and it will flash when it is not connected or during the connection.
8. When the crankshaft electric heating is turned on, "🔥" is displayed, and when the chassis electric heating is turned on manually, "🔥" flashes
9. "🏠🔥" will be displayed when the auxiliary electric heating is automatically turned on.
10. "🔒" is displayed when the screen is locked
11. "🔔" flashes when a fault is reported.

Key operation instructions:

1. "⏻" key:

Short press "⏻" as the exit key and return to the main page.

In the main interface, long press the "⏻" button for 3 seconds to turn on/off.

2. "M" mode key:

In the power-on state, press and hold "M" for 3 seconds to switch the working mode.

In the heating (cooling) + hot water mode, in the adjustment setting temperature interface, single press "M" to switch between the hot water setting temperature and the heating (cooling) setting temperature. When "IN" flashes, it means adjusting the heating (cooling) setting temperature, and "IN" is off, it means adjusting the hot water setting temperature.

3. "+" plus key

When powering on, in the main interface, single press "+" to adjust the current mode setting temperature;

In the main interface, long press the "+" key for 3 seconds to enter the unit status parameter query, cooperate with the "+" and "-" keys to browse the parameters, and press the "⏻" key to exit the parameter query.

System parameters table

Code	Parameters' name	Adjustment range	Defaults
P01	Return temp difference under heating and cooling mode	2°C~18°C	2°C
P02	Return temp difference under hot Water mode	2°C~18°C	5°C
P03	Hot water set temp	28°C~60°C	55°C
P04	Cooling set temp	7°C~30°C	12°C
P05	Heating set temp	15°C~50°C	50°C
P06	Set temp for exhaust protection (TP4)	50°C~125°C	110°C
P07	Set temp for recovery when exhaust temp is too high (TP0)	50°C~125°C	95°C
P08	Water temp compensation	-5°C~15°C	3°C
P09	Defrost frequency	30-120HZ	70HZ
P10	Defrost cycle	20MIN~90MIN	45MIN

P11	Defrost entry temp	-15°C~-1°C	-1°C
P12	Defrost time	5MIN~20MIN	12MIN
P13	Defrost exit temp	1°C~40°C	20°C
P14	The temp difference 1 between ambient and coil when defrosting	0°C~15°C	7°C
P15	The temp difference 2 between ambient and coil when defrosting	0°C~15°C	5°C
P16	Defrost ambient temp	0°C~20°C	12°C
A01	Main EEV action cycle	20S~90S	30S
A02	Main EEV heating target superheat 1	-5°C~10°C	3 T \geq 14°C
A03	Main EEV heating target superheat 2	-5°C~10°C	3 [9, 14)
A04	Main EEV heating target superheat 3	-5°C~10°C	3 [4, 9)
A05	Main EEV heating target superheat 4	-5°C~10°C	3 [-5, 4)
A06	Main EEV heating target superheat 5	-5°C~10°C	3 [-10, -5)
A07	Main EEV heating target superheat 6	-5°C~10°C	3 [-16, -10)
A08	Main EEV heating target superheat 7	-5°C~10°C	5 [-23, -16)
A09	Main EEV heating target superheat 8	-5°C~10°C	5 T<-23°C
A10	Main EEV cooling target superheat 1	-5°C~10°C	3 T \geq 38°C
A11	Main EEV cooling target superheat 2	-5°C~10°C	3 [30, 38)
A12	Main EEV cooling target superheat 3	-5°C~10°C	3 [25, 30)
A13	Main EEV cooling target superheat 4	-5°C~10°C	3 T<25°C
A14	Main EEV heating initial opening 00	0~480	150 Ambient temp.T \geq 14°C
A15	Main EEV heating initial opening 01	0~480	120[9, 14)
A16	Main EEV heating initial opening 02	0~480	100[4, 9)
A17	Main EEV heating initial opening 03	0~480	100[-5, 4)
A18	Main EEV heating initial opening 04	0~480	90[-10, -5)
A19	Main EEV heating initial opening 05	0~480	90[-16, -10)
A20	Main EEV heating initial opening 06	0~480	90[-23, -16)
A21	Main EEV heating initial opening 07	0~480	90 T<-23°C
A22	Main EEV cooling initial opening 00	0~480	450T \geq 38°C
A23	Main EEV cooling initial opening 01	0~480	400[30, 38)
A24	Main EEV cooling initial opening 02	0~480	350[25, 30)
A25	Main EEV cooling initial opening 03	0~480	300 T<25°C

A26	Main EEV hot water initial opening 00	0~480	350 T≥25℃
A27	Main EEV hot water initial opening 01	0~480	300[10, 25)
A28	Main EEV hot water initial opening 02	0~480	250[-10, 10)
A29	Main EEV hot water initial opening 03	0~480	200 T<-10℃
A30	Main EEV heating automatic adjustment lower limit 00	0~480	80 ambient temp T≥14℃
A31	Main EEV heating automatic adjustment lower limit 01	0~480	80[9, 14)
A32	Main EEV heating automatic adjustment lower limit 02	0~480	80[4, 9)
A33	Main EEV heating automatic adjustment lower limit 03	0~480	80[-5, 4)
A34	Main EEV heating automatic adjustment lower limit 04	0~480	80[-10, -5)
A35	Main EEV heating automatic adjustment lower limit 05	0~480	80[-16, -10)
A36	Main EEV heating automatic adjustment lower limit 06	0~480	80[-23, -16)
A37	Main EEV heating automatic adjustment lower limit 07	0~480	80 T<-23℃
A38	Main EEV exhaust temp adjustment	70℃~125℃	95℃
A39	Main EEV opening under defrost	20~450	450
A40	Main EEV minimum opening under Hot water mode	50~150	60
A41	Main EEV mode selection	0-automatic / 1-manual	0
A42	Main EEV manual steps	20~450	350
A43	Main EEV superheat proportional coefficient	1~6	5
A44	Main EEV superheat differential coefficient	1~180	1
A45	EEV initial adjustment mode	0 fixed/ 1adjustable	1
B01	Auxiliary EEV mode selection	0-auotomatic /1-manual	0

B02	Auxiliary EEV manual steps	20~450	350
B03	EVI electromagnetic expansion valve turn on temp	11°C~45°C	11°C
B04	Auxiliary EEV exhaust proportional coefficient	1~6	2
B05	Auxiliary EEV exhaust differential coefficient	0~180	1
B06	Auxiliary EEV superheat proportional coefficient	1~6	2
B07	Auxiliary EEV superheat differential coefficient	0~180	1
B08	Auxiliary EEV adjustment cycle	10~20	15
B09	Auxiliary EEV target exhaust temp	70~120	90
B10	Close auxiliary EEV exhaust temp	40~70	60
B11	Auxiliary EEV heating target superheat 1	-10~10	4 T _{≥14} °C
B12	Auxiliary EEV heating target superheat 2	-10~10	4 [9, 14)
B13	Auxiliary EEV heating target superheat 3	-10~10	4 [4, 9)
B14	Auxiliary EEV heating target superheat 4	-10~10	4 [-5, 4)
B15	Auxiliary EEV heating target superheat 5	-10~10	4 [-10, -5)
B16	Auxiliary EEV heating target superheat 6	-10~10	4 [-16, -10)
B17	Auxiliary EEV heating target superheat 7	-10~10	4 [-23, -16)
B18	Auxiliary EEV heating target superheat 8	-10~10	4 T < -23°C
B19	Auxiliary EEV heating initial opening 00	0~480	0 Ambient temp T _{≥14} °C
B20	Auxiliary EEV heating initial opening 01	0~480	10 [9, 14)
B21	Auxiliary EEV heating initial opening 02	0~480	30 [4, 9)

B22	Auxiliary EEV heating initial opening 03	0~480	50[-5, 4)
B23	Auxiliary EEV heating initial opening 04	0~480	50[-10, -5)
B24	Auxiliary EEV heating initial opening 05	0~480	50[-16, -10)
B25	Auxiliary EEV heating initial opening 06	0~480	60[-23, -16)
B26	Auxiliary EEV heating initial opening 07	0~480	60 T<-23°C
B27	Auxiliary EEV hot water initial opening 00	0~480	0 T≥25°C
B28	Auxiliary EEV hot water initial opening 01	0~480	0 [10, 25)
B29	Auxiliary EEV hot water initial opening 02	0~480	50 [-10, 10)
B30	Auxiliary EEV hot water initial opening 03	0~480	30 T<-10°C
B31	Auxiliary EEV heating automatic adjustment lower limit 00	0~480	30 Ambient Temp.T≥14°C
B32	Auxiliary EEV heating automatic adjustment lower limit 01	0~480	30 [9, 14)
B33	Auxiliary EEV heating automatic adjustment lower limit 02	0~480	30 [4, 9)
B34	Auxiliary EEV heating automatic adjustment lower limit 03	0~480	30 [-5, 4)
B35	Auxiliary EEV heating automatic adjustment lower limit 04	0~480	30 [-10, -5)
B36	Auxiliary EEV heating automatic adjustment lower limit 05	0~480	30 [-16, -10)
B37	Auxiliary EEV heating automatic adjustment lower limit 06	0~480	30 [-23, -16)
B38	Auxiliary EEV heating automatic adjustment lower limit 07	0~480	30 T<-23°C

B39	Auxiliary EEV opening under defrost	0~480	0
B40	Auxiliary EEV opening under cooling	0~480	0
B41	Auxiliary EEV hot water automatic adjustment lower limit 00	0~480	80 T \geq 25 $^{\circ}$ C
B42	Auxiliary EEV hot water automatic adjustment lower limit 01	0~480	100[10, 25)
B43	Auxiliary EEV hot water automatic adjustment lower limit 02	0~480	120[-10, 10)
B44	Auxiliary EEV hot water automatic adjustment lower limit 03	0~480	80 T<-10 $^{\circ}$ C
B45	Enthalpy valve exhaust temperature under heating (standby)	50~125 $^{\circ}$ C	75 $^{\circ}$ C T \geq 14 $^{\circ}$ C
B46	Enthalpy valve exhaust temperature under heating (standby)	50~125 $^{\circ}$ C	75 $^{\circ}$ C [9, 14)
B47	Enthalpy valve exhaust temperature under heating (standby)	50~125 $^{\circ}$ C	70 $^{\circ}$ C [4, 9)
B48	Enthalpy valve exhaust temperature under heating (standby)	50~125 $^{\circ}$ C	70 $^{\circ}$ C [-5, 4)
B49	Enthalpy valve exhaust temperature under heating (standby)	50~125 $^{\circ}$ C	65 $^{\circ}$ C [-10, -5)
B50	Enthalpy valve exhaust temperature under heating (standby)	50~125 $^{\circ}$ C	60 $^{\circ}$ C [-16, -10)
B51	Enthalpy valve exhaust temperature under heating (standby)	50~125 $^{\circ}$ C	60 $^{\circ}$ C [-23, -16)
B52	Enthalpy valve exhaust temperature under heating	50~125 $^{\circ}$ C	60 $^{\circ}$ C T<-23 $^{\circ}$ C

	(standby)		
B53	Enthalpy valve exhaust temperature under hot water (standby)	75°C 50~125°C	75°C 5 T≥25°C
B54	Enthalpy valve exhaust temperature under hot water (standby)	75°C 50~125°C	75°C [10, 25)
B55	Enthalpy valve exhaust temperature under hot water (standby)	50~125°C	60°C [-10, 10)
B56	Enthalpy valve exhaust temperature under hot water (standby)	50~125°C	60°C T<-10°C
B57	Enthalpy valve exhaust temperature under hot water (standby)	50~125°C	70°C T≥38°C
B58	Enthalpy valve exhaust temperature under hot water (standby)	50~125°C	70°C [30, 38)
B59	Enthalpy valve exhaust temperature under hot water (standby)	50~125°C	65°C [25, 30)
B60	Enthalpy valve exhaust temperature under hot water (standby)	50~125°C	65°C T<25°C
B61	Enthalpy valve turns on delay	0~180S	10S
B62	Auxiliary circuit enable under cooling	0 allow to turn on /1 not allowed	1
B63	Enthalpy valve turns off exhaust temp difference	0~30	5
B64	Auxiliary EEV heating exhaust temp difference	0~125°C	40°C T≥14°C
B65	Auxiliary EEV heating exhaust temp difference	0~125°C	40°C [9, 14)
B66	Auxiliary EEV heating exhaust temp difference	0~125°C	30°C [4, 9)

B67	difference	0~125℃	34℃ [-5, 4)
B68	Auxiliary EEV heating exhaust temp	0~125℃	40℃ [-10, -5)
B69	difference	0~125℃	40℃ [-16, -10)
B70	Auxiliary EEV heating exhaust temp	0~125℃	40℃ [-23, -16)
B71	difference	0~125℃	40℃ T<-23℃
B72	Auxiliary EEV hot water exhaust temp difference	0~125℃	35℃ T≥25℃
B73	Auxiliary EEV hot water exhaust temp difference	0~125℃	35℃ [10, 25)
B74	Auxiliary EEV hot water exhaust temp difference	0~125℃	35℃ [-10, 10)
B75	Auxiliary EEV hot water exhaust temp difference	0~125℃	35℃ T<-10℃
B76	Control mode of auxiliary EEV	0 Enthalpy superheat /1 exhaust super heat	0
C01	Water pump mode 1,non-stop;0,stop	0~1	1 (it is effective for heating And cooling mode)
C02	Pressure sensor: 1 effective/ 0 invalid	0~1	0
C03	High pressure protection value	25.0-50.0bar	42.0bar
C04	High pressure recovery value	25.0-50.0bar	36.0bar
C05	Low pressure protection value	0-20.0bar	0.5bar
C06	Low pressure recovery value	0-20.0bar	1.5bar
D01	AC wind speed switching ambient temp	-10~50℃	28
D02	AC wind speed switching ambient temp	-10~50℃	26
D03	Maximum speed 1 of DC motor under heating	0~1000	T≥14℃ 400
D04	Maximum speed 2 of DC motor under heating	0~1000	[9, 14) 700
D05	Maximum speed 3 of DC motor under heating	0~1000	[4, 9) 800
D06	Maximum speed 4 of DC motor under heating	0~1000	[-5, 4) 900
D07	Maximum speed 5 of DC motor under	0~1000	[-10, -5) 900

	heating		
D08	Maximum speed 6 of DC motor under heating	0~1000	[-16, -10) 900
D09	Maximum speed 7 of DC motor under heating	0~1000	[-23, -16) 900
D10	Maximum speed 8 of DC motor under heating	0~1000	T<-23℃ 900
D11	Heating Tw-Tp (Tlp) target value 1	0~30	T≥14℃ 2
D12	Heating Tw-Tp (Tlp) target value 2	0~30	[9, 14) 2
D13	Heating Tw-Tp (Tlp) target value 3	0~30	[4, 9) 2
D14	Heating Tw-Tp (Tlp) target value 4	0~30	[-5, 4) 2
D15	Heating Tw-Tp (Tlp) target value 5	0~30	[-10, -5) 2
D16	Heating Tw-Tp (Tlp) target value 6	0~30	[-16, -10) 2
D17	Heating Tw-Tp (Tlp) target value 7	0~30	[-23, -16) 2
D18	Heating Tw-Tp (Tlp) target value 8	0~30	T<-23℃ 2
D19	DC motor speed regulation cycle	10~180 S	30S
D20	Motor adjust speed per cycle	0~100 R	10 R
D21	Maximum speed 1 of DC motor under hot water mode	0~1000	T≥25℃ 500
D22	Maximum speed 2 of DC motor under hot water mode	0~1000	[10, 25) 700
D23	Maximum speed 3 of DC motor under hot water mode	0~1000	[-10, 10) 900
D24	Maximum speed 4 of DC motor under hot water mode	0~1000	T<-10℃ 900
D25	Hot water Tw-Tp (Tlp) target value 1	0~30	T≥25℃ 2
D26	Hot water Tw-Tp (Tlp) target value 2	0~30	[10, 25) 2
D27	Hot water Tw-Tp (Tlp) target value 3	0~30	[-10, 10) 2
D28	Hot water Tw-Tp (Tlp) target value 4	0~30	T<-10℃ 2
D29	Maximum speed 1 of DC motor under cooling mode	0~1000	T≥38℃ 900
D30	Maximum speed 2 of DC motor under cooling mode	0~1000	[30, 38) 800
D31	Maximum speed 3 of DC motor under cooling mode	0~1000	[25, 30) 700

D32	Maximum speed 4 of DC motor under cooling mode	0~1000	T<25℃ 500
D33	Heating valve function selection (stand by)	0 not allowed / 1 allow to turn on	1
D34	Four-way valve polarity	0: Power on cooling 1: Power on when heating	0
D35	The ambient temp when electric heating on	-30℃~20℃	-5℃
D36	How water setting max. parameter	20℃~60℃	55
D37	Cooling water setting Min. parameter	5℃~30℃	12
D38	Heating water setting Max. parameter	20℃~60℃	50

Note: The parameters B04 and B06 are actually divided by 10 (that is, the range is 0.1~0.6)

4. "-" minus key

When powering on, in the main interface, single press "-" to adjust the current mode setting temperature;

In the main interface, long press the "-" key for 3 seconds to enter the unit status parameter query, cooperate with the "+" and "-" keys to browse the parameters, and press the "power" key to exit the parameter query.











Machine status table 1: Long press "-" Key for 3 seconds

Query code	Description	Display range
01	Inlet water temp	-30~99℃
02	Outlet water temp	-30~99℃
03	Ambient temp	-30~99℃
04	Exhaust temp	0~125℃
05	Suction temp	-30~99℃
06	External coil temp	-30~99℃
07	Economizer inlet temp	-30~99℃
08	Economizer outlet temp	-30~99℃
09	Cooling coil temp	-30~99℃
10	Water tank temp	-30~99℃
11	Main EEV temp	
12	Auxiliary EEV temp	
13	Compressor current	
14	Heat sink temp	
15	DC bus voltage value	

16	Compressor actual frequency	
17	Low pressure sensor gauge pressure value(R410 gas)	measured (bar)
18	High pressure sensor gauge pressure value(R410 gas)	measured (bar)
19	DC Motor 1 speed	
20	DC Motor 2 speed	
21	Low pressure pressure conversion temperature	
22	High pressure pressure conversion temperature	





5. Setting button







Clock settings:

Press the  button to enter the clock setting state. First, the hour digit flashes, indicating that the hour value of the current time can be adjusted through the  and  buttons. Each time you press the  key, the hour increases by one, and each time you press the  key, the hour decreases by one. If you hold down the  or  key for a long time, the hour will automatically increase or decrease. After setting the hour digit, press the  button again; at this time, the minute digit flashes, indicating that the current time's minute value can be adjusted through the  and  buttons. After setting the minute value, press the  key again to end.

Timing setting:

Long press the  button for 3 seconds to enter the timing setting:

Enter the timing selection. At this time, the "timing on 1" clock "hour" flashes, and the hours can be set with  and ; press the  button again to switch to the clock "minutes", and the  and  buttons can be used to set the minutes. ;

Press the  button again to switch to the "timing off 1" setting: the clock "hour" flashes, and the hours can be set with the  and  keys; press the  button again to switch to the clock "minutes", with  ,  Key can set points;

Other time periods are set by analogy;

Press  to exit or confirm.

Press on the main interface, it will display the current number of set timing periods;

Cancel timing setting:

When the set power-on time and power-off time are the same, the timing setting of the current time period is cancelled.

6. Forced defrosting:

Press the "M" and "-" keys to enter the forced defrost mode.

When entering defrost, "❄️" is displayed.

7. Frequency parameter setting

Long press the "⏻" + "⚙️" key for 5 seconds to enter the password input state, the time display position displays "0000", press the "+" or "-" key to enter the password, and then press the "⚙️" key to switch the password digits. When the last password is entered, And then press "⚙️" to confirm the password.

Enter the 4-digit password "9615", and enter the manual frequency setting state after the input is completed, directly press the "+" "-" keys on the main page to adjust the manual frequency.

Enter the 4-digit password "8866", and enter the frequency view state after the input is completed, the original "hour" displays "target frequency", and the original "minute" displays "operating frequency".





Enter the 4-digit password "4180", after the input is completed, the buzzer will beep twice and enter the frequency conversion parameter setting

⦿ Frequency parameter table: long press [⏻] + [⚙️], enter "4180"

Code	Parameter name	Adjustment range	default	Remark
R00	Hot water frequency 1	30~120Hz	60 Hz	T≥25℃
R01	Hot water frequency 2	30~120Hz	60 Hz	[10, 25)
R02	Hot water frequency 3	30~120Hz	75 Hz	[-10, 10)
R03	Hot water frequency 4	30~120Hz	80 Hz	T<-10℃
R04	Heating frequency 1	30~120Hz	60 Hz	T≥14℃
R05	Heating frequency 2	30~120Hz	70 Hz	[9, 14)
R06	Heating frequency 3	30~120Hz	75 Hz	[4, 9)
R07	Heating frequency 4	30~120Hz	75 Hz	[-5, 4)
R08	Heating frequency 5	30~120Hz	80 Hz	[-10, -5)
R09	Heating frequency 6	30~120Hz	80 Hz	[-16, -10)
R10	Heating frequency 7	30~120Hz	85 Hz	[-23, -16)
R11	Heating frequency 8	30~120Hz	85 Hz	T<-23℃
R12	Cooling frequency 1	30~120Hz	75 Hz	T≥38℃
R13	Cooling frequency 2	30~120Hz	70 Hz	[30, 38)
R14	Cooling frequency 3	30~120Hz	70 Hz	[25, 30)
R15	Cooling frequency 4	30~120Hz	65 Hz	T<25℃

R16	Exhaust setting TP0	50~125℃	95℃	
R17	Exhaust setting TP1	50~125℃	100℃	
R18	Exhaust setting TP2	50~125℃	105℃	
R19	Exhaust setting TP3	50~125℃	110℃	
R20	Exhaust setting TP4	50~125℃	120℃	
R21	Lower limit of FM point 01	0~125Hz	125	
R22	Lower limit of FM point 02	0~125Hz	125	
R23	Lower limit of FM point 03	0~125Hz	125	
R24	Lower limit of FM point 04	0~125Hz	125	
R25	Upper limit of FM point 01	0~125Hz	125	
R26	Upper limit of FM point 02	0~125Hz	125	
R27	Upper limit of FM point 03	0~125Hz	125	
R28	Upper limit of FM point 04	0~125Hz	125	

8. Restore factory settings

In the shutdown state, press and hold the " " key + " " key + " " key + " " key at the same time for 3 seconds to restore the factory setting parameters by wire control. At this time, the buzzer will sound twice in succession, and all the parameter values will return to the default value.

5.4 FAULT CODE/ SYSTEM PROTECTION

Fault code	Description	Reason	Solution
Er 03	Water flow fault	1.The water system is blocked; 2.Improper installation of the inlet and outlet water temperature sensor detection position leads to inaccurate detection of water temperature; 3,The pump size is inappropriate	1. Clean the water pipe; 2. Check whether the probe position of the inlet and outlet water temperature sensor is correctly installed and reinforced; 3.Change the water pump;
Er 04	Anti-freezer in winter	The ambient temperature is lower than the antifreeze setting value.	1. Start the antifreeze cycle and start the antifreeze protection. 2. Drain the internal water and shut down if you don't use it for a long time .

Er 05	High pressure fault	<ol style="list-style-type: none"> 1. The external machine is dirty and blocked, affecting heat exchange; 2. The heat exchanger is dirty and blocked, which affects heat exchange; 3. The interface between the sensor and the motherboard is loose or falls off; 4. The sensor probe falls off; 5. The sensor connection line is open or short-circuited; 6. The sensor is damaged; 	<ol style="list-style-type: none"> 1. Clean the external coil 2. Clean or replace the heat exchanger. 3. Check and reinforce the interface between the sensor and the motherboard; 4. Re-fix the sensor probe; 5. Repair the sensor connection line; 6. Replace the sensor;
Er 06	Low pressure fault	<ol style="list-style-type: none"> 1. Insufficient refrigerant; 2. The evaporator is blocked or the fin surface is dirty; 3. The low pressure switch is broken; 	<ol style="list-style-type: none"> 1,Inject the refrigerant . 2,Clean evaporator . 3,Change the low pressure switch .
Er 09	Communication fault	<ol style="list-style-type: none"> 1. The communication wiring between the compressor drive and the main control board is loose; 2. The communication wiring between the compressor drive and the main control board is broken; 3. The connection position of the drive end or the main control end is incorrectly selected; 4. The compressor drive is damaged and not powered on. 	<ol style="list-style-type: none"> 1. Check whether the connection position of the communication line at both ends of the driver and the main control is correct; 2. Check whether the communication wiring is broken or loose, if so, replace the communication line; 3. Check whether the compressor drive is normally powered on; (the LED flashes when the compressor drive is working normally);
Er 10	Communication failure between inverter modules(main board is disconnected with drive board)	<ol style="list-style-type: none"> 1. The communication wiring between the compressor drive and the main controller is loose; 2. The communication wiring between the compressor drive and the main controller is disconnected; 3. The connection position of the drive end or the main control end is incorrectly selected; 4. The compressor drive is damaged and not powered on. 	<ol style="list-style-type: none"> 1. Check whether the connection position of the communication line at both ends of the driver and the main control is correct; 2. Check whether the communication wiring is broken or loose, if so, replace the communication line; 3. Check whether the compressor drive is normally powered on; (the LED flashes when the compressor drive is working normally);

Er 12	Overheating protection of exhaust temp	<ol style="list-style-type: none"> 1. Insufficient refrigerant. 2. The system is blocked 	<ol style="list-style-type: none"> 1. Leak detection and repair of the system and charge refrigerant according to the parameters. 2. Check the system and troubleshoot.
Er 14	Water tank sensor fault	<ol style="list-style-type: none"> 1, The set temperature is too high. 2. The interface between the sensor and the main board is loose or falls off; 3. The sensor probe falls off; 4. The sensor connection wire is open or short-circuited; 5. The sensor is damaged; 	<ol style="list-style-type: none"> 1. Lower the set temperature 2. Check and reinforce the interface between the sensor and the main board; 3. Re-fix the sensor probe; 4. Repair the sensor connection line; 5. Replace the sensor;
Er 15	Inlet water temp sensor fault	<ol style="list-style-type: none"> 1. The interface between the sensor and the main board is loose or falls off; 2. The sensor probe falls off; 3. The sensor connection wire is open or short-circuited; 4. The sensor is damaged; 	<ol style="list-style-type: none"> 1. Check and reinforce the interface between the sensor and the main board; 2. Re-fix the sensor probe; 3. Repair the sensor connection line; 4. Replace the sensor;
Er 16	External coil sensor fault	<ol style="list-style-type: none"> 1. The interface between the sensor and the main board is loose or falls off; 2. The sensor probe falls off; 3. The sensor connection wire is open or short-circuited; 4. The sensor is damaged; 	<ol style="list-style-type: none"> 1. Check and reinforce the interface between the sensor and the main board; 2. Re-fix the sensor probe; 3. Repair the sensor connection line; 4. Replace the sensor;
Er 18	Exhaust temp sensor fault	<ol style="list-style-type: none"> 1. The interface between the sensor and the main board is loose or falls off; 2. The sensor probe falls off; 3. The sensor connection wire is open or short-circuited; 4. The sensor is damaged; 	<ol style="list-style-type: none"> 1. Check and reinforce the interface between the sensor and the main board; 2. Re-fix the sensor probe; 3. Repair the sensor connection line; 4. Replace the sensor;
Er 20	Inverter modules abnormal protection	<ol style="list-style-type: none"> 1. The fan is not working properly; 2. Dirty fins cause poor heat dissipation; 3. The drive module is damaged; 	<ol style="list-style-type: none"> 1. Check whether the fan is working normally; 2. Clean the outer fins; 3. Replace the drive module;

Er 21	Ambient temp fault	<ol style="list-style-type: none"> 1. The interface between the sensor and the main board is loose or falls off; 2. The sensor probe falls off; 3. The sensor connection wire is open or short-circuited; 4. The sensor is damaged; 	<ol style="list-style-type: none"> 1. Check and reinforce the interface between the sensor and the main board; 2. Re-fix the sensor probe; 3. Repair the sensor connection line; 4. Replace the sensor;
Er 23	Over-cooling protection of outlet water under cooling mode	<ol style="list-style-type: none"> 1. The interface between the sensor and the main board is loose or falls off; 2. The sensor probe falls off; 3. The sensor connection wire is open or short-circuited; 4. The sensor is damaged; 	<ol style="list-style-type: none"> 1. Check and reinforce the interface between the sensor and the main board; 2. Re-fix the sensor probe; 3. Repair the sensor connection line; 4. Replace the sensor;
Er 26	Heat sink temp fault	<ol style="list-style-type: none"> 1. The fan is not working properly; 2. Dirty fins cause poor heat dissipation; 3. The drive module is damaged; 	<ol style="list-style-type: none"> 1. Check whether the fan is working normally; 2. Clean the outer fins; 3. Replace the drive module;
Er 27	Outlet water temp sensor fault	<ol style="list-style-type: none"> 1. The interface between the sensor and the main board is loose or falls off; 2. The sensor probe falls off; 3. The sensor connection wire is open or short-circuited; 4. The sensor is damaged; 	<ol style="list-style-type: none"> 1. Check and reinforce the interface between the sensor and the main board; 2. Re-fix the sensor probe; 3. Repair the sensor connection line; 4. Replace the sensor;
Er 29	Suction temp sensor fault	<ol style="list-style-type: none"> 1. The interface between the sensor and the main board is loose or falls off; 2. The sensor probe falls off; 3. The sensor connection wire is open or short-circuited; 4. The sensor is damaged; 	<ol style="list-style-type: none"> 1. Check and reinforce the interface between the sensor and the main board; 2. Re-fix the sensor probe; 3. Repair the sensor connection line; 4. Replace the sensor;
Er 32	Overheating protection of outlet water temp under heating mode	<ol style="list-style-type: none"> 1. The temperature setting is too high 2. Insufficient water flow 3. Sensor failure 	<ol style="list-style-type: none"> 1. <i>Lower the set temperature</i> 2. <i>Increase water flow</i> 3. <i>Check the sensor and replace or repair it.</i>

Er 33	Overheating for coil temp	<ol style="list-style-type: none"> 1. The sensor is faulty. 2. Dirty coils and insufficient heat exchange. 3. Insufficient water flow or blockage of heat exchanger 	<ol style="list-style-type: none"> 1. Check the sensor and replace or repair it. 2. Cleaning the coil 3. Increase the water flow and check the heat exchanger.
Er 34	Overheating for inverter modules	<ol style="list-style-type: none"> 1. The fan is not working properly; 2. Dirty fins cause poor heat dissipation; 3. The drive module is damaged; 	<ol style="list-style-type: none"> 1. Check whether the fan is working normally; 2. Clean the outer fins; 3. Replace the drive module;
Er 42	Cooling coil temp sensor fault	<ol style="list-style-type: none"> 1. The sensor is faulty. 2. Dirty coils and insufficient heat exchange. 3. Insufficient water flow or blockage of heat exchanger 	<ol style="list-style-type: none"> 1. Check the sensor and replace or repair it. 2. Cleaning the coil 3. Increase the water flow and check the heat exchanger.
Er 62	Economizer inlet temp sensor fault	<ol style="list-style-type: none"> 1. The interface between the sensor and the main board is loose or falls off; 2. The sensor probe falls off; 3. The sensor connection wire is open or short-circuited; 4. The sensor is damaged; 	<ol style="list-style-type: none"> 1. Check and reinforce the interface between the sensor and the main board; 2. Re-fix the sensor probe; 3. Repair the sensor connection line; 4. Replace the sensor;
Er 63	Economizer outlet temp sensor fault	<ol style="list-style-type: none"> 1. The interface between the sensor and the main board is loose or falls off; 2. The sensor probe falls off; 3. The sensor connection wire is open or short-circuited; 4. The sensor is damaged; 	<ol style="list-style-type: none"> 1. Check and reinforce the interface between the sensor and the main board; 2. Re-fix the sensor probe; 3. Repair the sensor connection line; 4. Replace the sensor;
Er 64	DC motor 1 fault	<ol style="list-style-type: none"> 1. The DC fan wire is damaged; 2. The DC fan is jammed and blocked; 3. The main board is damaged; 	<ol style="list-style-type: none"> 1. Check whether the DC fan wiring is correct and whether it is broken; 2. Check whether the DC fan blades are stuck and whether it can rotate normally, otherwise change the fan; 3. Change the main board;

Er 66	DC motor 2 fault	<ol style="list-style-type: none"> 1. The DC fan wire is damaged; 2. The DC fan is jammed and blocked; 3. The main board is damaged; 	<ol style="list-style-type: none"> 1. Check whether the DC fan wiring is correct and whether it is broken; 2. Check whether the DC fan blades are stuck and whether it can rotate normally, otherwise change the fan; 3. Change the main board;
Er 67	Low pressure sensor fault	<ol style="list-style-type: none"> 1. The low pressure switch is damaged. 2. Insufficient refrigerant. 3. The evaporator is blocked or the fin surface is dirty. 	<ol style="list-style-type: none"> 1. Replace the low pressure switch. . 2. Increase refrigerant. 3. Clean the evaporator.
Er 68	High pressure sensor fault	<ol style="list-style-type: none"> 1. The system is blocked 2. Sensor failure 3. Insufficient water flow 	<ol style="list-style-type: none"> 1. Check the system and troubleshoot. 2. Replace the sensor. 3. Check the waterway and increase the water flow
Er 69	Low pressure protection	<ol style="list-style-type: none"> 1. The temperature sensor probe is faulty 2. Insufficient refrigeration system 	<ol style="list-style-type: none"> 1. Replace the temperature sensor 2. Increase the refrigeration system
Er 70	High pressure protection	<ol style="list-style-type: none"> 1. The system is blocked; 2. The compressor is worn out; 	<ol style="list-style-type: none"> 1. Leak detection and repair of the system and charge refrigerant according to the parameters. 2. Check the system and troubleshoot.

©E20 fault will display the following fault serial numbers at the same time, and switch the fault code every 3 seconds; among them, faults 1~128 are displayed first.



No. 257~384 will be displayed when there are no 1~128 faults. If two or more faults of the same priority occur at the same time, it will show serial number accumulation. For example, if the 16th and 32nd faults occur at the same time, 48 will be displayed.



Code serial No	Name	Description	Handling suggestion
1	IPM over current	IPM module problem	Replace the inverter module
2	Abnormal compressor synchronization	Compressor fault	Replace the compressor
4	Standby	--	--
8	Compressor output lack phase	Poor connection of compressor wiring	Check the compressor input wire

16	Low DC bus voltage	Input voltage is too low, PFC module fault	Check the input voltage, replace the module
32	High DC bus voltage	Input voltage is too high, PFC module fault	Replace the inverter module
64	Heat sink temp is too high	Fan motor fault, blocked air duct	Check the fan motor and air duct
128	Heat sink sensor fault	Heat sink sensor short circuit or open circuit fault	Replace inverter module
257	Communication fault and heat sink temp is too high	The inverter module did not receive the command from main board	Check the communication wire between inverter module and main board
258	Power input lack phase	Input lack phase (it is valid for three phase)	Check the input cable
260	Power input over current	Input three-phase unbalanced (it is valid for three-phase module)	Check the input three phase voltage
264	Power input voltage is too low	Input voltage is too low	Check the input voltage
272	High pressure fault	Compressor high pressure fault(standby)	
288	IPM temp is too high	Fan motor fault, blocked air duct	Check the fan motor and air duct
320	compressor peak current is too high	The line current of the compressor is too large, and the driver does not match the compressor	Replace the inverter module
384	PFC module temp is too high	PFC module temp is too high	Check the PFC module

5.5. WIFI CONTROL FUNCTION

WIFI settings

Press the  key +  key at the same time for 3 seconds to enter the "default mode" network configuration, the  icon flashes quickly when entering;

At the same time, press the  button + the  key for 3 seconds to enter the "compatibility mode" network configuration, the  icon flashes slowly when entering;

1. Software download and installation:

Enter " Multi-Machine" in Google Play and App Store, search for Multi-Machine APP, download and install;

2. Software start

After the installation is complete, click the "" icon on the desktop to start the software.



Multi-Machine

2. 1 Configure the device

2.1.1 Add device

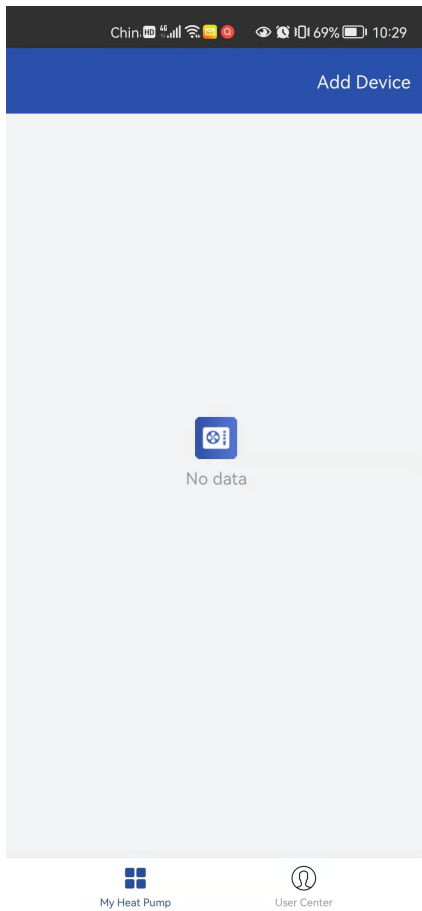

After entering the interface for adding a device, click "Add Device" to select the device type:

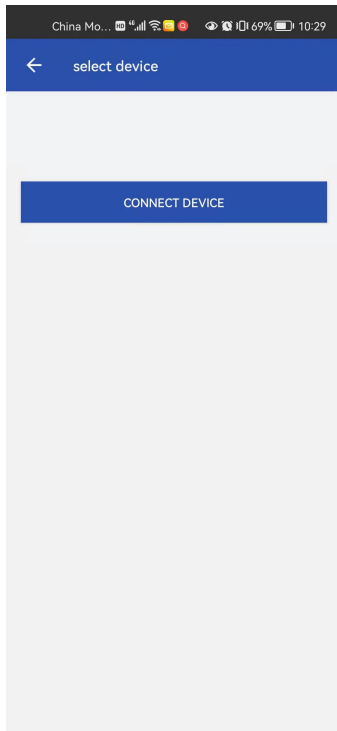

Select device type

2.6.3 Device matching

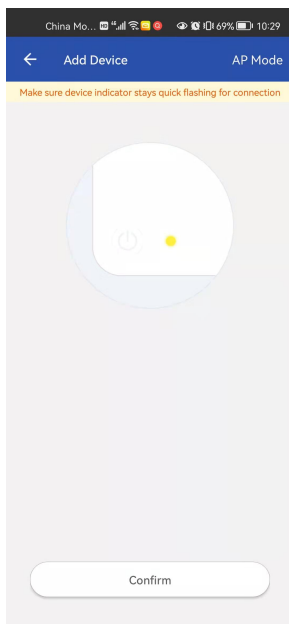

When the WIFI connection mode is selected and the WIFI indicator of the device flashes quickly, click Connect

After entering the device matching interface, the WIFI connection mode is selected by default, and the operation is performed according to the actual situation of the device;
The connection mode can also choose the hotspot mode;

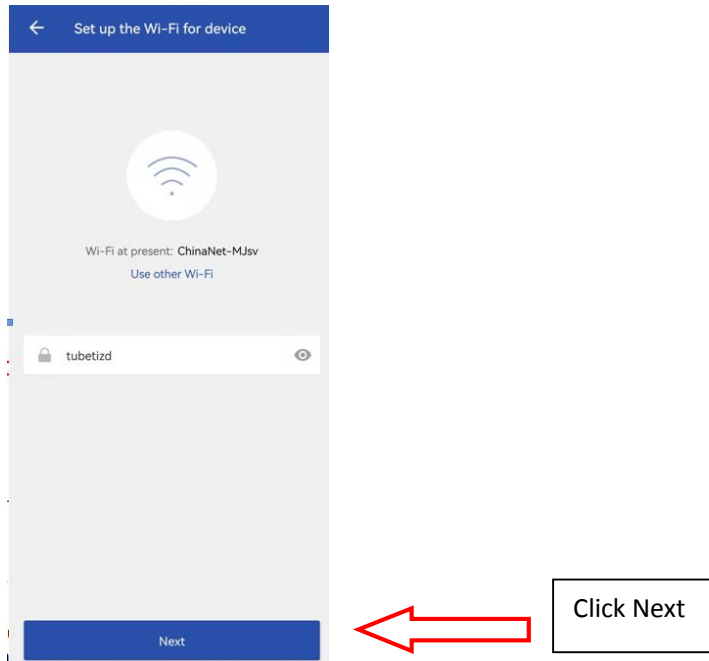

After connecting the corresponding WIFI, you can complete the device matching

2.7 Menu interface

After the APP and the device are matched, the home interface can select the device to operate

2.7.1 Menu main interface

The main interface of the menu can display the current system operating mode, water tank temperature, working status of various outputs, function keys and adjustable setting parameters;

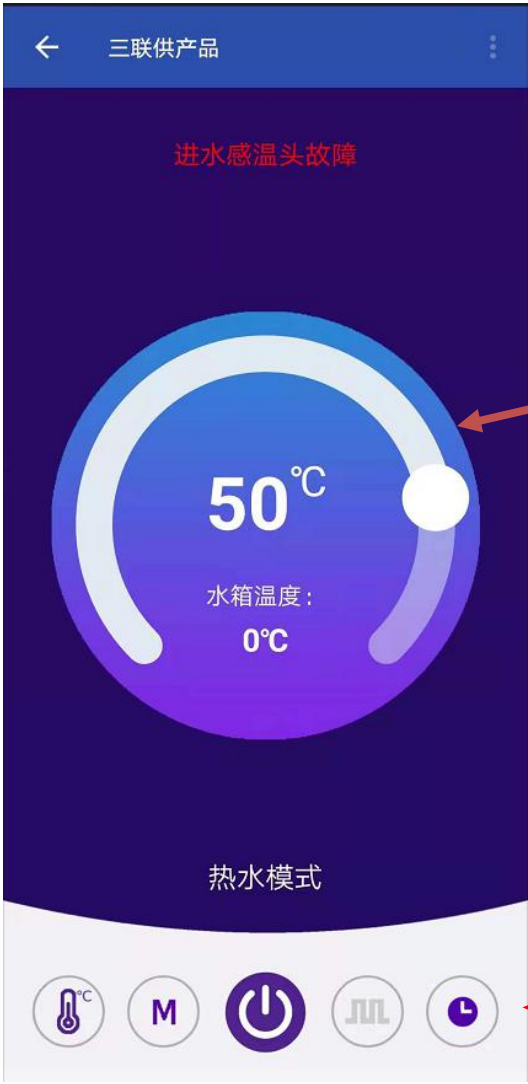

By sliding the button, you can adjust the setting parameters

Function buttons

VI SYSTEM OPERATION AND MAINTENANCE

6.1 SYSTEM DIAGNOSTIC TEST

6.1.1 ELCTRICAL MAINTENANCE

Inspect and handle the electrical connections according to the following items.

1. Complete electrical insulation test: Find unqualified contacts and handle them. The cutouts of control parts or the air switches should on disconnect state during the test to avoid damage to the control panels by high voltage;
2. Statically check whether the contact of each contactor is flexible and has no jamming;
3. Dust off electrical and control components with a brush or dry compressed air;
4. Check whether the contacts of the contactor contacts with arcing or burning marks. Replace it if needed;
5. Tighten the electrical connection terminals;
6. Check that whether the plug-in quick connector is in good contact. If it is found to be loose, replace the terminal.

6.1.2 CONTROL MAINTENANCE

Perform visual inspection, simple function detection, and handling the control section according to the following items.

1. Check the appearance of the power transformer and isolation transformer, and detect the output voltage of them;
2. Check that it the surface of the control interface board, display control board, sensor board, etc. with aging phenomenon.
3. Clean dust and dirt on each electrical control component and control panel by brush and electronic dust remover;
4. Check and tighten the output and input plug interfaces of the control interface board, including the connection between the display control board & the control interface board, and the connection between the control interface board & the temperature-humidity sensor board;
5. Check the connection between the user terminal and the control interface board;
6. Check the output connection of the control interface board to each contactor & to the input connection of the fan overload protector & to high and low voltage switch, etc. Should focus on inspection high-low voltage switches and electronic expansion valves, etc.. If any loose or poor contact occurs, replace them immediately;
7. Replace electrical components such as control panels that have been tested for problems;
8. Check the specifications and aging of the power connection, and replace the connection if necessary;

6.2 CREAMING SYSTEM

Parts of the refrigeration system must be inspected monthly to see if the system is functioning properly and if there are signs of wear. Unit failures usually occur before the device fails or damage, therefore periodic inspections are the primary means of preventing most system failures. When the refrigeration system fails, the fault can be judged according to some parameters of the system operation.

6.2.1 PLATE HEAT EXCHANGER

Brazed plate heat exchanger has self-cleaning function thanks to the high-strength turbulence in the channel of it. However, in some applications fouling is more likely to occur. For example when the water is hard water with high temperature. In this case, it is necessary to use a circulating flushing device to clean the heat exchanger. Pump weak acid -- 5% phosphoric acid or 5% oxalic acid (If the heat exchanger is frequently cleaned) into the heat exchanger and clean it.

Plate cleaning is not included in the company's maintenance, if necessary, you can consult the company's service personnel.

6.2.2 COMPRESSOR REPLACEMENT

WARNING

When changing the compressor, you must avoid touching the refrigerant and lubricating oil. If touched, it can cause severe skin burns or frostbite. Long-sleeved gloves must be worn when handling contaminated parts.

Build-in high efficiency scroll compressor in the system with high reliability. If the construction carry out strictly in accordance with the correct procedures, the probability of failure during operation is very low. Compressor motors rarely burn out due to insulation failure. In the events that the motor is indeed burnt out, most of them were caused by not good mechanical or not good lubrication, namely, high temperature overheating.

If problems that could cause compressor failure can be detected and corrected early, most compressor failures can be avoided. Maintenance personnel regularly perform maintenance inspections on situations in which abnormal operation may occur. Instead of replacing them after a compressor failure, it is better to take necessary steps to ensure proper system operation. It is not only more easier but also the cost will be more lower.

When diagnosing the compressor, check that all the electrical components of the compressor are functioning properly:

1. Check all fuses and circuit breakers;
2. Check the operation of high pressure switches and low pressure switches;
3. If the compressor fails, find out that the compressor failure is caused by electrical faults or mechanical faults.

6.2.3 MECHANICAL FAULTS

The mechanical failure of the compressor cannot be judged by smelling the burning odor. Try rotating the motor and if a mechanical fault is confirmed, the compressor must be replaced. If the motor burnt out, correct the factors that cause the motor to burn out and clean the system. It should be noted that the compressor motor burnout is usually caused by improper cleaning of the system.

6.2.4 ELECTRICAL FAULT

Electrical faults can be judged by a noticeable pungent odor. In the event of a severe burn, the oil will turn black and acidic. In the event of electrical failure and the refrigeration compressor motor is completely burned out, measures must be taken to clean the system to eliminate acid in the system and to prevent such failures in the system.

NOTE:

Damage of compressor replacement parts which caused by improper cleaning, according to the applicable warranty is not binding.

When the compressor is completely burned, replace the compressor and replace the filter, and check the throttling components. If there is a fault, it should be replaced. Before the replacement, the cleaning system is necessary. If the cleaning method is not clear, please consult our professional and technical personnel.

6.2.5 PROCEDURE FOR REPLACING THE COMPRESSOR

Cut off the power;

Connect the interface of the pressure gauge to the needle valve on the suction pipe for refrigerant recovery;

NOTE:

The refrigerant must be recycled or disposed of in accordance with relevant regulations. The release of refrigerant into the atmosphere is harmful to the environment and is illegal.

-
1. Remove the electrical connection to the compressor;
 2. Loosen the nozzle on the suction and exhaust ports of the compressor;
 3. Remove the faulty compressor;
 4. If the compressor is completely burned, the refrigeration system piping should be cleaned and the filter should be replaced;

NOTE:

The new compressor should not unplug the rubber plug of the suction and exhaust ports too early. The compressor without plug in the air should no more than 15 minutes to prevent the compressor from absorbing water and bringing it to the system.

-
5. Install the new compressor in place and connect the pipe nozzle. Connecting electrical lines;
 6. Vacuum the system and add refrigerant; the vacuuming time is more than 60 minutes, and the vacuum should be kept more than 10 minutes. After ensuring normal of the vacuum, the refrigerant can be added according to the rating plate parameters.
 7. Power on the system according to the normal start up debugging process, and check whether the system running parameters are normal.

VI FAULT DIAGNOSE AND TREATMENT

This part introduce fault diagnose and treatment.

Note: Certain circuits have lethal high voltages that allow only professional technicians to perform maintenance operations on the unit. Special care must be taken when troubleshooting with power on.

See Table 7-1 for fault diagnosis and treatment of each component.

Figure 7-1 Trouble shooting of compressor and cooling system

ERRO CODE	Fault name	Reasons	Measures
F2	Inlet water temp Twi sensor fault	1. The interface between the sensor and the main board is loose or detached. 2. The sensor probe comes off. 3. The sensor connection line is open or shorted. 4. The sensor is damaged.	1. Check and reinforce the interface between the sensor and the main board. 2. Re-fix the sensor probe. 3. Repair the sensor cable. 4. Replace the sensor.
F3	Liquid pipe temp sensor fault	1. The interface between the sensor and the main board is loose or detached. 2. The sensor probe comes off. 3. The sensor connection line is open or shorted. 4. The sensor is damaged.	1. Check and reinforce the interface between the sensor and the main board. 2. Re-fix the sensor probe. 3. Repair the sensor cable. 4. Replace the sensor.
F4	Outlet water temp Two sensor fault	1. The interface between the sensor and the main board is loose or detached. 2. The sensor probe comes off. 3. The sensor connection line is open or shorted. 4. The sensor is damaged.	1. Check and reinforce the interface between the sensor and the main board. 2. Re-fix the sensor probe. 3. Repair the sensor cable. 4. Replace the sensor.
F1	Tw temp sensor fault (reserved)	1. The interface between the sensor and the main board is loose or detached. 2. The sensor probe comes off.	1. Check and reinforce the interface between the sensor and the main board. 2. Re-fix the sensor probe. 3. Repair the sensor cable.

		3. The sensor connection line is open or shorted. 4. The sensor is damaged.	4. Replace the sensor.
F5	Protection for water flow switch off	1. Insufficient water flow. 2. There is air in the circulating water inlet pipe. 3. The circulation pump is damaged. 4. The water flow switch is damaged.	1. Clean the Y filter and increase the water flow. 2. Vent the air in the circulating water inlet pipe. 3. Check the circulation pump and capacitor and repair it. 4. Replace the water flow switch.
F9	Protection for anti-freezing switch off under cooling mode	/	/
FA	Insufficient water flow protection	1. Dirty waterway blocked; 2. Improper installation of inlet and outlet water temperature sensor detection position leads to inaccurate water temperature detection 3. Water pump is too small;	1. Cleaning the waterway; 2. Check whether the position of the water temperature sensor is correctly installed and reinforced; 3. Change the water pump.
"8888"flash	Communication failure between controller and main board	1. The interface between the operation panel and main board is loose. 2. The signal line is open.	1. Check the operation panel and motherboard. 2. Strengthen the interface. 3. Replace the signal cable.
A4	Discharge temp TD temp sensor fault	1. The interface between the sensor and the main board is loose or detached. 2. The sensor probe comes off. 3. The sensor connection line is open or shorted. 4. The sensor is damaged.	1. Check and reinforce the interface between the sensor and the main board. 2. Re-fix the sensor probe. 3. Repair the sensor cable. 4. Replace the sensor.
A7	Suction temp Ts temp sensor fault	1. The interface between the sensor and the main board is loose or detached. 2. The sensor probe comes off. 3. The sensor connection	1. Check and reinforce the interface between the sensor and the main board. 2. Re-fix the sensor probe. 3. Repair the sensor cable. 4. Replace the sensor.

		line is open or shorted. 4. The sensor is damaged.	
A2	Defrost coil temp Tdef temp sensor fault	1.The interface between the sensor and the main board is loose or detached. 2.The sensor probe comes off. 3.The sensor connection line is open or shorted. 4. The sensor is damaged.	1. Check and reinforce the interface between the sensor and the main board. 2. Re-fix the sensor probe. 3. Repair the sensor cable. 4. Replace the sensor.
		1.	1.
A1	Outdoor ambient temp Tao temp sensor fault	1.The interface between the sensor and the main board is loose or detached. 2. The sensor probe comes off. 3.The sensor connection line is open or shorted. 4.The sensor is damaged.	1.Check and reinforce the interface between the sensor and the main board. 2. Re-fix the sensor probe. 3. Repair the sensor cable. 4. Replace the sensor.
A8	Coil temp Tcm temp sensor fault	1.The interface between the sensor and the main board is loose or detached. 2.The sensor probe comes off. 3.The sensor connection line is open or shorted. 4.The sensor is damaged.	1.Check and reinforce the interface between the sensor and the main board. 2. Re-fix the sensor probe. 3. Repair the sensor cable. 4. Replace the sensor.
Ab	High pressure Pd sensor fault	1.The interface between the sensor and the main board is loose or detached. 2. The sensor probe comes off. 3.The sensor connection line is open or shorted. 4. The sensor is damaged.	1. Check and reinforce the interface between the sensor and the main board. 2. Re-fix the sensor probe. 3. Repair the sensor cable. 4. Replace the sensor.
H3	outdoor unit EEPROM fault	1. The memory chip is damaged;	1. Replace the main control board;
P6	High-pressure switch disconnect protection	1. The external machine is dirty and blocked, which affects the heat exchange; 2,The heat exchanger is dirty and blocked, affecting	Check the system for troubleshooting;

		heat exchange;	
P9	Low-pressure switch disconnect protection	1. Insufficient refrigerant; 2. The evaporator is blocked or the fin surface is dirty; 3. The low pressure switch is broken;	1. Inject suitable refrigerant . 2. Clean evaporator 3. Replace of low pressure switch .
P1	High pressure is too high protection under cooling mode	The machine is dirty and blocked ,affecting heat exchanger	Check the system for troubleshooting;
LC	Communication failure between main board and compressor drive	1.Communication wiring between compressor drive and main board is loose or broken; 2. The drive terminal or main board terminal connection position is not selected correctly; 3.Compressor drive is damaged and not powered on.	1. Check whether the connection position of the communication cable at both ends of the driver and the main control board is correct; 2. Check whether the communication wiring is broken or loose. If so, replace the communication cable; 3.Check whether the compressor drive is powered on normally (the LED will flash when the compressor drive is working normally);
C4	Discharge temp Td is too high protection	1.Insufficient refrigerant; 2.The system is blocked; 3.The compressor is worn;	1.System leak detection and repair and charge refrigerant according to parameters; 2.Check the system for troubleshooting; 3.Replace the compressor;
C7	Exhaust overheating is too low protection	/	/
Y3	DC motor 1 fault	1. The DC motor line is damaged; 2. The DC motor is blocked and causes stall; 3.Main board is damaged;	1. Check whether the DC motor wiring is correct and whether it is disconnected; 2. Check whether the fan of the DC motor is stuck and whether it can turn normally, otherwise change the fan; 3.Change the main board
H5	Four way valve fault	1. The four-way valve is incorrectly connected to the main controller; 2. The four-way valve is disconnected; 3. The parameters are not set correctly;	1. Check whether the four-way valve is connected correctly and whether it is disconnected; 2.Check whether the No. 13 parameter of the remote controller is set correctly;
b9	Drive IPM over temperature protection	1. The fan is not working properly; 2. Poor heat dissipation due to dirty blockage of external machine fins; 3.The drive module is damaged;	1. Check if the fan is working normally; 2. Clean up the external fins; 3. Replace the drive module;
b5	Drive input overcurrent protection	1. When reporting B6, the input voltage is abnormal and wait for the power grid	1. When reporting B6, if the power grid is normal, replace the drive;

b5	Drive compressor phase current overcurrent protection	to be normal; 2. The U / V / W phase wiring at the compressor is loose; 3. U / V / W phase connection at the compressor end is reversed or falls off 4. The compressor driving parameters are incorrect; 5. Compressor is damaged;	2. Check whether the U / V / W three-phase of the compressor is correctly connected; 3. Check whether the compressor driving parameters are correctly matched with the running compressor; 4. Replace the compressor drive; 5. If the compressor still does not start after the drive is replaced, and a "click" sound is issued, the compressor is damaged and the compressor is replaced.
b6	Drive DC bus voltage over and under voltage protection		
b7	Drive heatsink temperature sensor failure		
b1	Drive module protection (FO)		
b2	Drive module hardware protection		
b4	Compressor is not connected		
bA	Compressor out of step or failed to start		

Note 1: In the event of compressor high-pressure, low-pressure, overload, excessive exhaust temperature protection, or drive failure, after the fault is locked, it needs to be restored after power-off and power-on.

Product warranty card

User		User address	
Phone No.		Postal Code	
Saler name		Invoice No.	
Purchase date		Installed date	
Unit model			
Unit Series No.			
<p>Dear customers, please tick \checkmark below. Thank you for your valuable comments.</p> <p>1、 Install service: Very good <input type="checkbox"/> Good <input type="checkbox"/> Ordinary <input type="checkbox"/> Bad <input type="checkbox"/></p> <p>2、 The effect of cooling or heating: Very good <input type="checkbox"/> Good <input type="checkbox"/> Ordinary <input type="checkbox"/> Bad <input type="checkbox"/></p> <p>3、 The effect of hot water: Very good <input type="checkbox"/> Good <input type="checkbox"/> Ordinary <input type="checkbox"/> Bad <input type="checkbox"/></p> <p>Your suggestion:</p>			
Installed name (Stamp)		Technical service centre (Stamp)	
