



PM135 Powermeter Series PM135P/PM135E/PM135EH

Installation and Operation Manual



LIMITED WARRANTY

The manufacturer offers the customer a 24-month functional warranty on the instrument for faulty workmanship or parts from date of dispatch from the distributor. In all cases, this warranty is valid for 36 months from the date of production. This warranty is on a return to factory basis.

The manufacturer does not accept liability for any damage caused by instrument malfunction. The manufacturer accepts no responsibility for the suitability of the instrument to the application for which it was purchased.

Failure to install, set up or operate the instrument according to the instructions herein will void the warranty.







Only a duly authorized representative of the manufacturer may open your instrument. The unit should only be opened in a fully anti-static environment. Failure to do so may damage the electronic components and will void the warranty.

The greatest care has been taken to manufacture and calibrate your instrument. However, these instructions do not cover all possible contingencies that may arise during installation, operation or maintenance, and all details and variations of this equipment are not covered by these instructions.

For additional information regarding installation, operation or maintenance of this instrument, contact the manufacturer or your local representative or distributor.

WARNING

Read the instructions in this manual before performing installation and take note of the following precautions:

	Ensure that all incoming AC power and other power sources are turned OFF before performing any work on the instrument. Protect the measurement AC Inputs voltage (V1, V2, V3) with 2A external overcurrent protection device and the power supply source inputs with 5A external overcurrent protection device, located close to the equipment.
	Before connecting the instrument to the power source, check the labels on the back of the instrument to ensure that your instrument is equipped with the appropriate power supply voltage, input voltages and currents. Failure to do so may result in serious or even fatal injury and/or equipment damage.
	Under no circumstances should the instrument be connected to a power source if it is damaged.
	To prevent potential fire or shock hazard, do not expose the instrument to rain or moisture.
	The secondary of an external current transformer must never be allowed to be open circuit when the primary is energized. An open circuit can cause high voltages, possibly resulting in equipment damage, fire and even <u>serious or fatal injury</u>. Ensure that the current transformer wiring is secured using an external strain relief to reduce mechanical strain on the screw terminals, if necessary.
	Only qualified personnel familiar with the instrument and its associated electrical equipment must perform setup procedures.
	Do not open the instrument under any circumstances when it is connected to a power source.



Do not use the instrument for primary protection functions where failure of the device can cause fire, injury or death. The instrument can only be used for secondary protection if needed.



Read this manual thoroughly before connecting the device to the current carrying circuits. During operation of the device, hazardous voltages are present on input terminals. Failure to observe precautions can result in serious or even fatal injury or damage to equipment.



This equipment does not require cleaning for proper operation

All trademarks are property of their respective owners.

Copyright © 2007-2012

Quick Start Guide

This section can be used by a licensed electrician to install and perform basic PM135 setup. For more detailed PM135 setup and use instructions, see the following chapters in this manual.

This quick start guide will assist you to have the unit running for the first time.

During the operation of the meter, hazardous voltages are present in the input terminals. Failure to observe precautions can result in serious or even fatal injury or damage to equipment.

For complete and accurate in-depth instructions, refer to the following chapters in this manual.

1. Installing the PM135

Mounting the PM135 Unit

To mount the PM135:

1. Position the PM135 unit in the square or round cutout. If two PM135 are positioned side by side, take care of proper interval between them.
2. Attach the PM135 unit using washers and nuts. Make sure that the unit is securely attached into the wall or cabinet fixture.

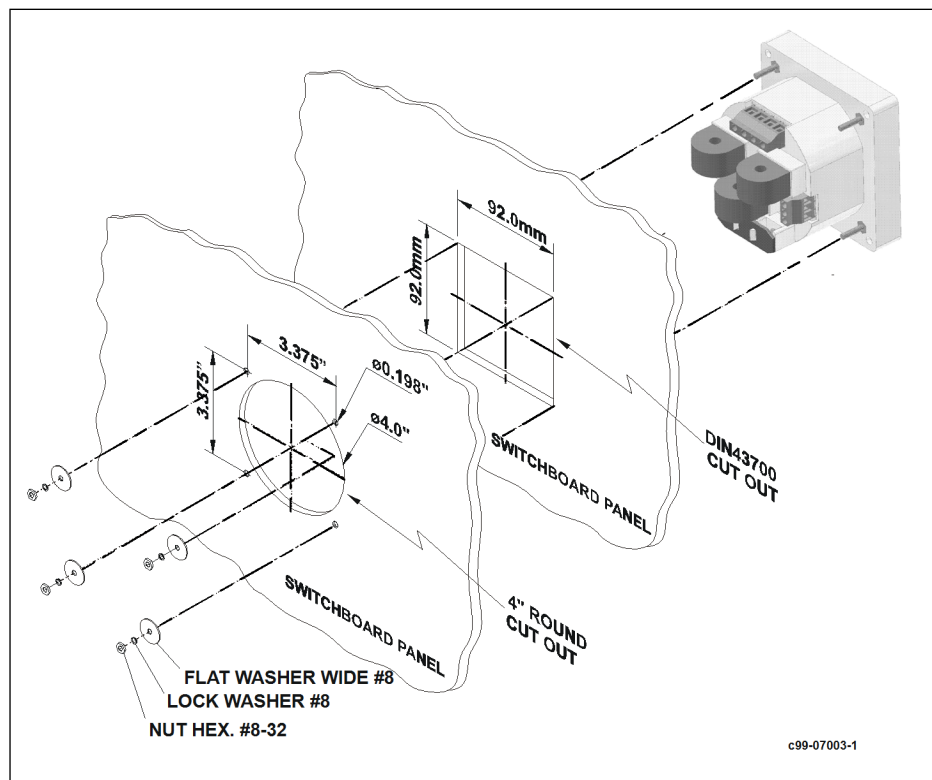

Mounting the PM135 (Square or Round Cut-out)

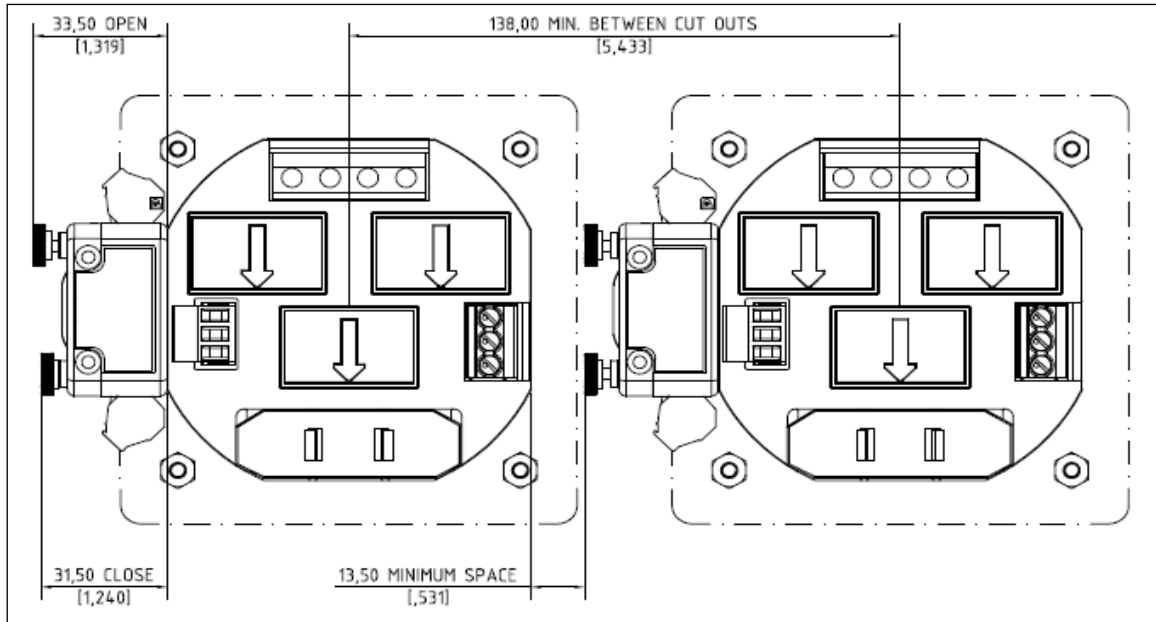

Mounting two PM135 side by side

Connecting the PM135 Unit

To connect the PM135:

1. Ensure that all incoming power sources are OFF.
2. Check that you have the appropriate power supply.
3. Connect to the external CT by passing the external CT wire through the meter CT core. Observe the arrow that indicates the current direction.
4. In case of a retrofit application where each external CT ends with two wires:
 - Pass one wire through the meter CT core.
 - Connect the wire to one of the meter termination screws.
 - Connect the second wire from the external CT to the termination screw.
5. Connect the measured voltage inputs
6. Connect COM1 – RS-485 communication port
7. Connect the Power Supply inputs using 1.5 mm²/14AWG-dedicated wires.

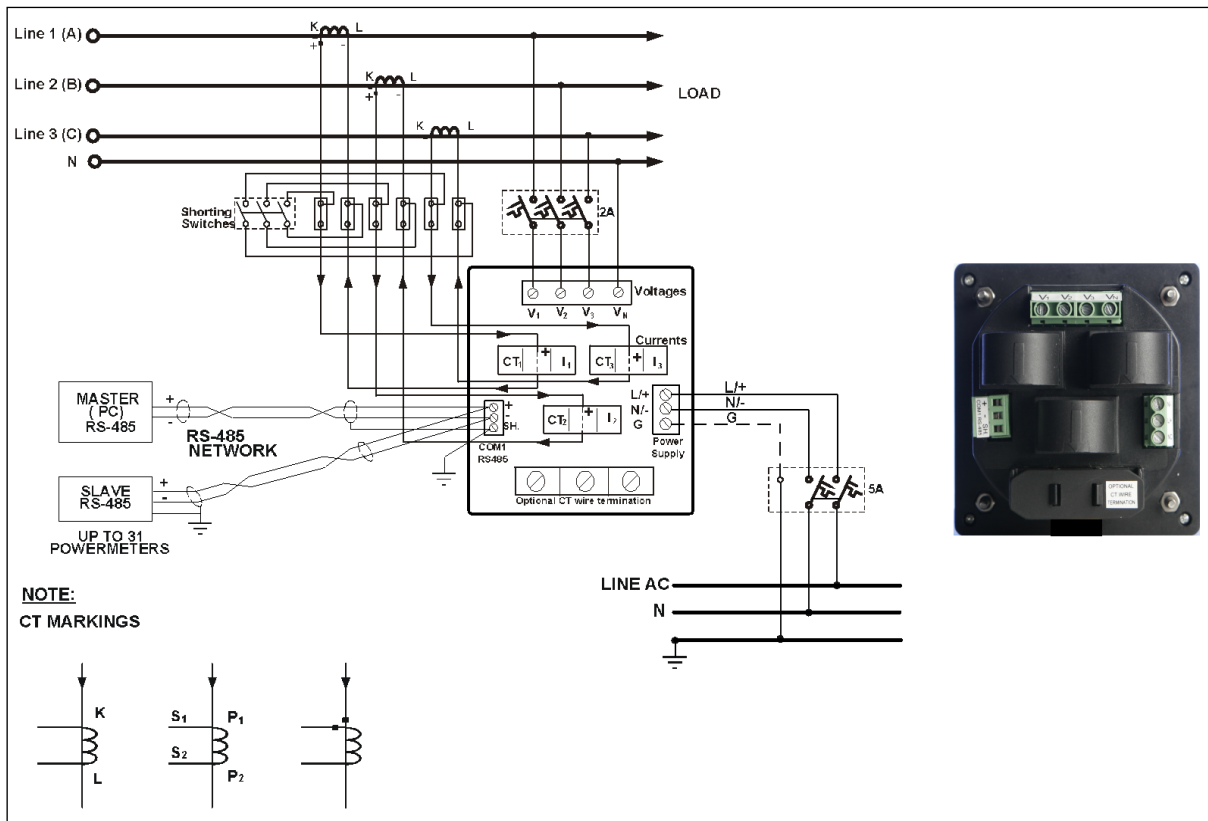

Common Wiring Mode: 4LL3 or 4Ln3

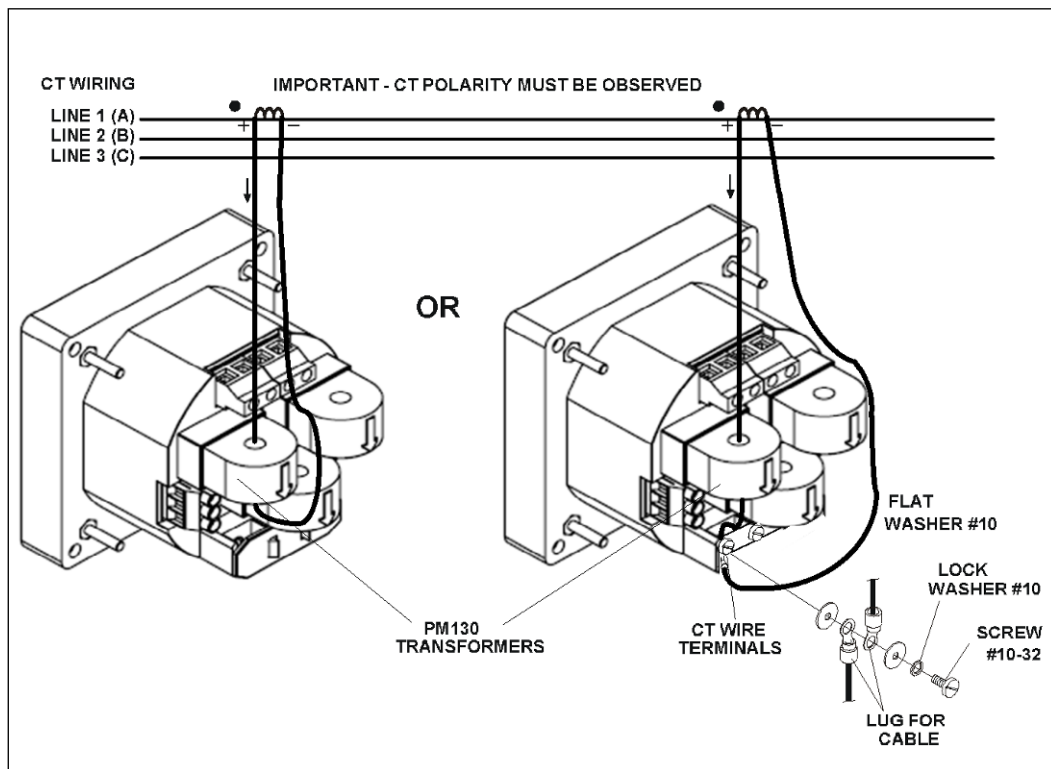

CT wiring

To connect an Option module:

1. Assemble the module on the meter.
2. Power the PM135 unit on.

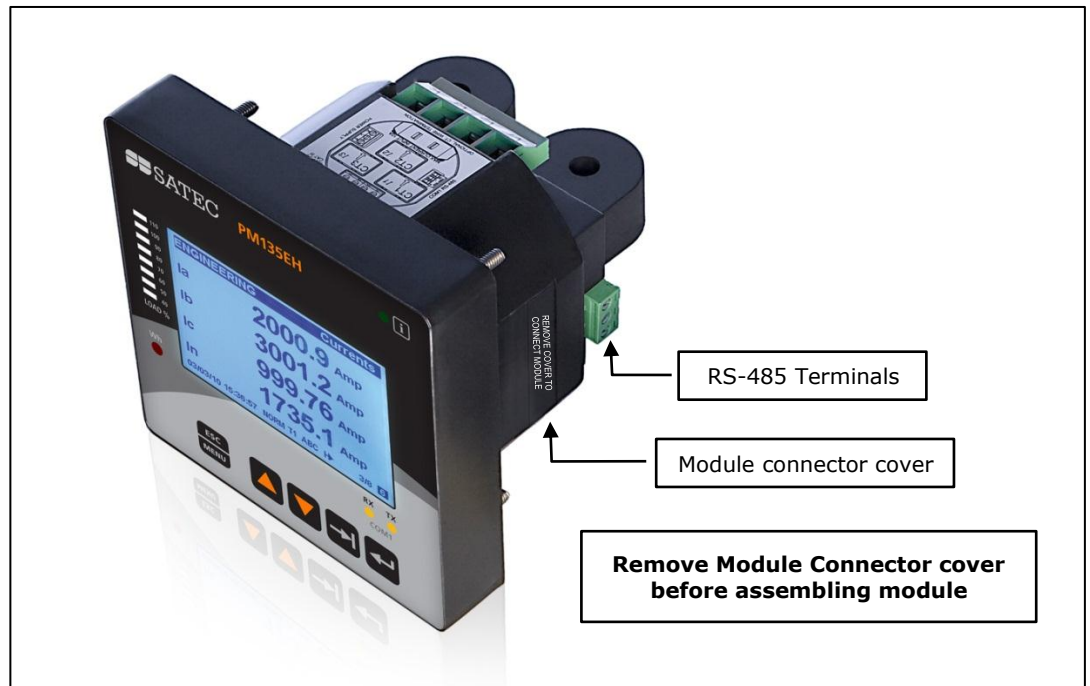

Assembling a module

To operate the PM135:

1. Perform device diagnostics.
2. Configure the device through the PM135 unit front panel display.

2. Configuring the PM135 remotely

1. Install the PAS application software on your PC.
2. Configure the PAS database for your meter.
3. Configure the PAS communications settings.
4. Upgrade the meter firmware if a new version is available.
5. Set up the meter using the PAS application software.
6. Configure your security settings through the meter security setup.
7. Configure your communication protocol settings.
8. Configure Billing/TOU registers.

At this stage, the PM135 should be ready for operation.

Table of Contents

Chapter 1 General Information	12
1.1 Features.....	13
1.2 Available Options	14
Digital I/O	15
Analog Output	15
Additional Communication Port – COM2.....	15
TOU - Battery-Operated Clock Unit.....	15
1.3 Customized Options	15
Device Resolution.....	16
Energy Rollover	16
Display Options.....	16
1.4 Measured Parameters	16
Chapter 2 Installation	19
2.1 Site Requirements	19
2.2 Package Contents.....	19
2.3 Mechanical Installation.....	19
Panel Mounting	20
DIN Rail Mounting	20
2.4 Electrical Installation.....	22
Typical Installation	22
Terminals	23
Power Source Connection.....	23
Voltage Input connection	24
Current Input Connection.....	24
Wiring Diagrams	25
2.5 I/O Connections	30
4DI/2DO Module.....	30
12DI/4RO Module	31
4AO Module - Analog Outputs.....	33
TOU module – RTC and 4 Digital Inputs.....	33
2.6 Communications Connections.....	35
COM1 RS-485 Connection	36
ETH module – COM2 Ethernet Connection.....	36
PRO module – COM2 PROFIBUS Connection.....	37
RS-232/422-485 module – COM2 Connection	38
GPRS/GSM modem module – COM2 GPRS connection	39
Chapter 3 Using Front Display	40
3.1 Display Operations	40
Navigation Buttons.....	41
Navigating in Data Display Mode.....	42
Status Indicators.....	42
Display Features	43
3.2 Data Displays.....	45
TEST Mode Data Display	45
Billing Period Data Displays	46
Measurements Maximum Demand Data Display	49
Measurements Data Display	50
Measurements Minimum/Maximum Data Display.....	53

Measurements Energy Data Display	54
Harmonics Display	55
Waveform Display	56
Phasor Display	56
Digital I/O	56
Device Control Display	57
Basic Settings Display	58
Device Info Display	58
Load Bar Graph	58
Energy Pulse LED	59
Port Activity LEDs.....	59
3.3 Device Setup.....	60
Entering the Password	60
Viewing and Changing Setup Options	60
Viewing and Changing Setup Options	61
Chapter 4 Using PAS Software.....	62
4.1 Installing PAS.....	62
4.2 Creating a New Site for your Meter	62
4.3 Setting up Communications	63
Communicating through a Serial Port	64
Communicating through the Internet	65
4.4 Setting Up the Meter	66
Preparing Setups for the Meter	66
Downloading Setups to the Meter	67
Uploading Setups from the Meter.....	68
4.5 Authorization	68
Chapter 5 Configuring the PM135	70
5.1 Configuring Communications.....	70
Setting Up Serial Communication Ports.....	70
Setting Up Ethernet.....	72
Setting Up GPRS Network	73
Setting Up eXpertPower Client.....	75
Setting Up TCP Notification Client.....	76
5.2 General Meter Setup	78
Basic Meter Setup	78
Transformer Correction.....	80
Device Options	81
Configuring Digital Inputs.....	82
Configuring Relay Outputs.....	84
Configuring Analog Outputs.....	85
Configuring Counters.....	87
Configuring Alarm/Control Setpoints.....	88
Configuring the Display	92
Updating the meter Clock.....	93
Local Time Settings	93
5.3 Configuring Meter Security	95
5.4 Configuring Billing/TOU	98
Configuring Billing/Tariff Registers.....	98
Configuring the Daily Tariff Schedule	100
Configuring the Season Tariff Schedule.....	100
5.5 Configuring Recorders.....	103
Configuring Meter Memory	103
Configuring the Event Recorder	105

Configuring the Data Recorder.....	105
5.6 Configuring Communication Protocols.....	109
Configuring Modbus.....	109
Configuring DNP3.....	110
Chapter 6 Device Control and Upgrading	113
6.1 Resetting Accumulators, Maximum Values and Files	113
6.2 Viewing and Clearing Device Diagnostics	115
6.3 Viewing Communication Status and Statistics.....	116
6.4 Remote Relay Control	116
6.5 Upgrading Device Firmware.....	117
Chapter 7 Monitoring Meters.....	120
7.1 Viewing Real-time Data.....	120
7.2 Viewing Real-time Min/Max Log	122
7.3 Viewing Real-time Waveforms	123
7.4 Viewing Real-time Harmonic Spectrum	125
Chapter 8 Retrieving and Storing Files	128
8.1 Uploading Files on Demand	128
8.2 Using the Upload Scheduler.....	129
8.3 Viewing Files On-line.....	131
8.4 Exporting Files.....	131
Exporting Files in COMTRADE and PQDIF Formats.....	131
Exporting Files in Excel Format	133
8.5 Archiving Files	133
Chapter 9 Viewing Files	135
9.1 Operations with Files	135
9.2 Viewing Options.....	135
Customizing Views	135
Working with Tables	136
Working with Graphic Windows.....	137
9.3 Viewing the Event Log	138
9.4 Viewing the Data Log.....	140
Appendix A Technical Specifications	141
Appendix B Analog Output Parameters.....	148
Appendix C Setpoint Triggers and Actions	150
Appendix D Parameters for Data Monitoring and Logging.....	153
Appendix E Billing/TOU Profile Log File.....	162
Appendix F Data Scales	164
Appendix G Device Diagnostic Codes.....	165
Index	166

Designations used throughout the manual:

E - available in the PM135E

EH - available in the PM135EH

Chapter 1 General Information

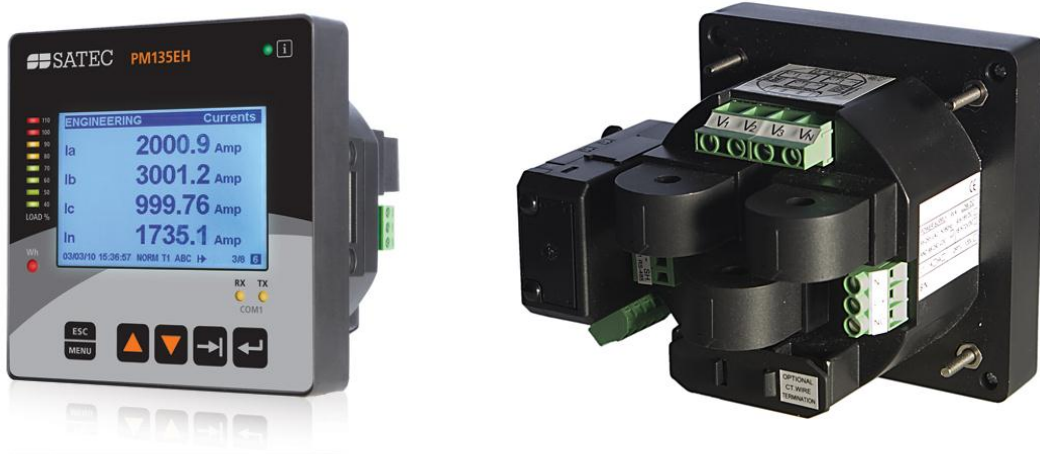

The PM135 is a compact, multi-function, three-phase AC Powermeter specially designed to meet the requirements of users ranging from electrical panel builders to substation operators.

⇒ The PM135 measuring and power supply inputs comply with Measuring Category II

The PM135 comprises of three types of models:

- **PM135P:** the basic model which offers standard voltage, current, power and frequency measurements, and control capabilities. A special amp-demand version can be ordered with a simplified display layout especially suitable for current measurements.
- **PM135E:** offers all the features of the basic model energy measurements and data logging.
- **PM135EH:** offers all the features of the **PM135E** with harmonic analysis capabilities.

The PM135 units include:

- A 3.5" Monochrome Graphic LCD display enabling easy reading of local meters, and can be provided in different languages¹.
- A standard RS-485 communication port and a second optional Ethernet, PROFIBUS or RS-232/RS-422/RS-485 port. These ports allow local and remote automatic meter readings and setup through the supplemental communication or user data acquisition software.
- Different communication options for remote communications with the meter. These options enable LAN and Internet communication with the unit.

All models are suitable for mounting on both 4-inch round and 92×92mm square cutouts.

¹ Contact your local distributor for the desired Display languages support.

1.1 Features

Multifunctional 3-phase Power Meter

- 3 voltage inputs and 3 current transformer-isolated AC inputs for direct connection to power line or via potential and current transformers
- True RMS, volts, amps, power, power factor, neutral current, voltage and current unbalance, frequency
- Ampere/Volt demand meter
- 25/50/60/400 Hz measurement capabilities

Billing/TOU Energy Meter (PM135E and PM135EH)

- Class 0.5S IEC 62053-22 four-quadrant active and reactive energy polyphase static meter
- Three-phase total and per phase energy measurements; active, reactive and apparent energy counters
- Time-of-Use, 4 totalization and tariff energy/demand registers x 8 tariffs, 4 seasons x 4 types of days, 8 tariff changes per day,
- One-time easy programmable tariff calendar schedule
- Automatic daily energy and maximum demand profile log for total and tariff registers

Harmonic Analyzer (PM135EH)

- Voltage and current THD, current TDD and K-Factor, up to 40th order harmonic
- Voltage and current harmonic spectrum and angles

Real-time Waveform Capture

- Real-time "scope mode" waveform monitoring capability
- Simultaneous 6-channel one-cycle waveform capture at a rate of 64 samples per cycle

Programmable Logical Controller

- Embedded programmable controller
- 16 control setpoints; programmable thresholds and delays
- Relay output control (see [Available Options](#))
- 1-cycle response time

Event and Data Recording (PM135E and PM135EH)

- Non-volatile memory for long-term event and data recording
- Event recorder for logging internal diagnostic events and setup changes
- Two data recorders; programmable data logs on a periodic basis; automatic daily energy and maximum demand profile log

Digital I/O

- Optional four digital inputs with 1-ms scan time; automatic recording of last five digital input change events with timestamps (see the PM135 Modbus Reference Guide)
- Optional two relay outputs with 1-cycle update time; unlatched, latched, pulse and KYZ operation; energy pulses

Display

- 3.5 inch Monochrome Graphic LCD display with 240 x 128 dots resolution, adjustable update time backlit and user defined brightness setting
- Auto-scroll option with adjustable page exposition time; auto-return to a default page
- LED bar graph showing percent load with respect to user-definable nominal load current

Real-time Clock

- Internal clock with 20-second retention time
- Optional battery-operated clock unit (see [Available Options](#))

Communications

- Standard 2-wire RS-485 communication port; MODBUS RTU, DNP3, and SATEC ASCII communication protocols
- Optional second communication port (see [Available Options](#)); MODBUS RTU, MODBUS/TCP, DNP3, DNP3/TCP, SATEC ASCII and PROFIBUS DP communication protocols
- eXpertPower™ client for communicating with the SATEC proprietary eXpertPower™ Internet services (with the Ethernet module or with the RS-232 module using an external GPRS modem, see [Setting Up eXpertPower Client](#))
- TCP notification client for communicating with a remote MODBUS/TCP server on events or periodically on a time basis (with the Ethernet module or with the RS-232 module using an external GPRS modem, see [Setting Up TCP Notification Client](#))

Meter Security

- Password security for protecting meter setups and accumulated data from unauthorized changes

Upgradeable Firmware

- Easy upgrading device firmware through a serial or Ethernet port.

Software Support

- PAS – free meter configuration and data acquisition tool
- eXpertPower™ – SATEC proprietary Internet services

1.2 Available Options

The PM135 can be provided with an optional expansion module from the following list:

- Digital I/O
- Analog outputs
- TOU - Battery-operated clock unit
- Ethernet communication port
- PROFIBUS DP communication port
- RS-232/RS-422/RS-485 communication port
- GPRS communication port

Digital I/O

The PM135 digital I/O expansion module provides:

4DI/2DO module

- 4 dry contact digital inputs (DI) for monitoring external contacts and receiving pulses from energy, water, and gas meters
- Programmable de-bounce time; 1-ms scan time.
- 2 electro-mechanical or solid-state relay outputs (RO) for alarms and controls, and for output energy pulses; unlatched, latched and pulse operations, failsafe operation for alarm notifications; programmable pulse width; direct remote relay control through communications; 1-cycle update time.

12DI/4DO module

- 12 dry contact digital inputs (DI) for monitoring external contacts and receiving pulses from energy, water, and gas meters
- Programmable de-bounce time; 1-ms scan time.
- 4 electro-mechanical relay outputs (RO) for alarms and controls, and for output energy pulses; unlatched, latched and pulse operations, failsafe operation for alarm notifications; programmable pulse width; direct remote relay control through communications; 1-cycle update time.

Analog Output

The PM135 analog output (AO) expansion module provides:

- 4 optically isolated analog outputs with an internal power supply;
- Options for 0-20mA, 4-20mA, 0-1mA, and ± 1 mA output; 1-cycle update time.

Additional Communication Port – COM2

A second COM2 communication port can be ordered as an expansion module. COM2 options available:

- Ethernet 10/100BaseT port; MODBUS/TCP , DNP3/TCP and IEC 60870-5-104 communications protocols
- PROFIBUS DP port
- RS-232/RS-422/RS-485 port; MODBUS RTU, DNP3, SATEC ASCII and IEC 60870-5-101 communication protocols;
- GPRS communications port

TOU - Battery-Operated Clock Unit

The TOU module provides:

- A precise clock with battery backup; 6-year clock retention time
- 4 dry contact digital inputs (DI) for monitoring external contacts and receiving pulses from energy, water and gas meters; programmable de-bounce time; 1-ms scan time.

1.3 Customized Options

Presentation of data on the front display and via communications can be customized to best suit the user application.

Device Resolution

A low or high-resolution option can be selected for the presentation of voltage, current, and power for use in high and low power applications. See [Measurement Units](#) for more information.

Energy Rollover

The energy rollover limit can be changed in the meter to provide 4-digit to 9-digit energy resolution. See [Device Options](#) in Chapter 5 for details. The meter display is capable of showing full 9-digit energy counters using two LED windows.

Display Options

Different display options are available for customization to be used in dark or non-safe locations, or in places that are hardly accessible for observation. See [Configuring the Display](#) in Chapter 5 for more information.

1.4 Measured Parameters

Table 1: Measured and Displayed Parameters

Parameter	Display	Comm.	Analog	Pulse	Alarm
1-cycle Real-time Measurements					
RMS Voltage per phase	✓	✓	✓		✓
RMS Current per phase	✓	✓	✓		✓
kW per phase	✓	✓			✓
kvar per phase	✓	✓			✓
kVA per phase	✓	✓			✓
Power Factor per phase	✓	✓			✓
Total kW	✓	✓	✓		✓
Total kvar	✓	✓	✓		✓
Total kVA	✓	✓	✓		✓
Frequency	✓	✓	✓		✓
Neutral Current	✓	✓	✓		✓
Total Power Factor	✓	✓	✓		✓
Voltage & Current unbalance	✓	✓			✓
1-sec Average Measurements					
RMS Voltage per phase	✓	✓	✓		✓
RMS Current per phase	✓	✓	✓		✓
kW per phase	✓	✓			✓
kvar per phase	✓	✓			✓
kVA per phase	✓	✓			✓
Power Factor per phase	✓	✓			✓
Total kW	✓	✓	✓		✓
Total kvar	✓	✓	✓		✓
Total kVA	✓	✓	✓		✓
Total Power Factor	✓	✓	✓		✓
Frequency	✓	✓	✓		✓
Neutral Current	✓	✓	✓		✓
Voltage & Current unbalance	✓	✓			✓
Amps & Volt Demands					
Ampere & Volt Demand per phase	✓	✓			✓

Parameter	Display	Comm.	Analog	Pulse	Alarm
Ampere Maximum Demand per phase	✓	✓			✓
Voltage Maximum Demand per phase	✓	✓			✓
Power Demands E, EH					
kW Accumulated Demand Import & Export		✓	✓		✓
kvar Accumulated Demand Import & Export		✓	✓		✓
kVA Accumulated Demand		✓	✓		✓
kW Demand Import & Export		✓			✓
kvar Demand Import & Export		✓			✓
kVA Demand		✓			✓
kW Sliding Demand Import & Export		✓			✓
kvar Sliding Demand Import & Export		✓			✓
kVA Sliding Demand		✓			✓
kW Predicted Demand Import & Export		✓			✓
kvar Predicted Demand Import & Export		✓			✓
kVA Predicted Demand		✓			✓
kW Maximum Demand Import	✓	✓			
kW Maximum Demand Export	✓	✓			
kvar Maximum Demand Import	✓	✓			
kvar Maximum Demand Export	✓	✓			
kVA Maximum Demand	✓	✓			
Total Energy E, EH					
Total kWh Import & Export	✓	✓		✓	
Total kvarh Import & Export	✓	✓		✓	
Total kvarh Net		✓			
Total kVAh	✓	✓		✓	
Energy per Phase E, EH					
kWh Import per phase	✓	✓			
kvarh Import per phase	✓	✓			
kVAh per phase	✓	✓			
TOU Registers E, EH					
4 TOU energy registers (kWh and kvarh import & export, kVAh, 4 pulse sources)	✓	✓			
4 TOU maximum demand registers	✓	✓			
8 tariffs, 4 seasons x 4 types of day	✓	✓			✓
Harmonic Measurements EH					
Voltage THD per phase	✓	✓			✓
Current THD per phase	✓	✓			✓
Current TDD per phase	✓	✓			✓
K-factor per phase	✓	✓			✓
Voltage harmonics per phase up to order 40	✓	✓			
Current harmonics per phase up to order 40	✓	✓			
Voltage harmonic angles up to order 40	✓	✓			
Current harmonic angles up to order 40	✓	✓			
Fundamental Component EH					
Voltage and Current per phase	✓	✓			
kW, PF per phase	✓	✓			
kvar, KVA per phase	✓	✓			
Total kW, PF	✓	✓			
Total kvar, KVA	✓	✓			
Min/Max Logging					
Min/Max A, V, total kW, kvar, kVA, PF	✓	✓			

Parameter	Display	Comm.	Analog	Pulse	Alarm
Min/Max Frequency, Neutral current	✓	✓			
Phase Rotation	✓	✓			✓
Voltage and Current Phase Angles	✓	✓			
Day and Time	✓	✓			
Pulse Counters	✓	✓			✓
Digital Inputs (optional)	✓	✓			✓
Relay Outputs (optional)	✓	✓			✓
Remote Relay Control (optional)		✓			
Alarm Triggers/Setpoints		✓			✓
Self-diagnostics	✓	✓			

Chapter 2 Installation

This chapter discusses the following types of physical installations for the PM135 Powermeter:

- Mechanical Installation
- Electrical Installation
- I/O Connections
- COM Port Connections.

2.1 Site Requirements

- Environmental conditions: as specified in Technical Specifications in Appendix A
- Electrical requirements: as specified in Technical Specifications in Appendix A

See [Technical Specifications](#) in Appendix A for more details

2.2 Package Contents

The PM135 Powermeter package contains the following items:

- PM135 Powermeter unit
- Technical Documentation CD
- Optional accessories (depending on the options ordered, if any)
- Cables

2.3 Mechanical Installation

Refer to the figures provided in this section to properly perform the mechanical installation.

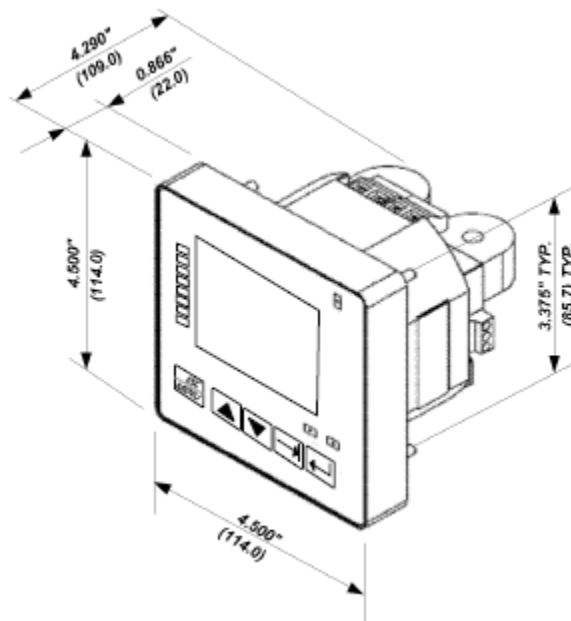

Figure 2-1. Dimensions

Panel Mounting

To mount the meter in cutout (ANSI 4" round or DIN 92x92mm square cutout):

1. Position the meter in the cutout.
2. Affix the meter using washers and nuts. (Add short text on Panel Mounting, a heading should always have text)

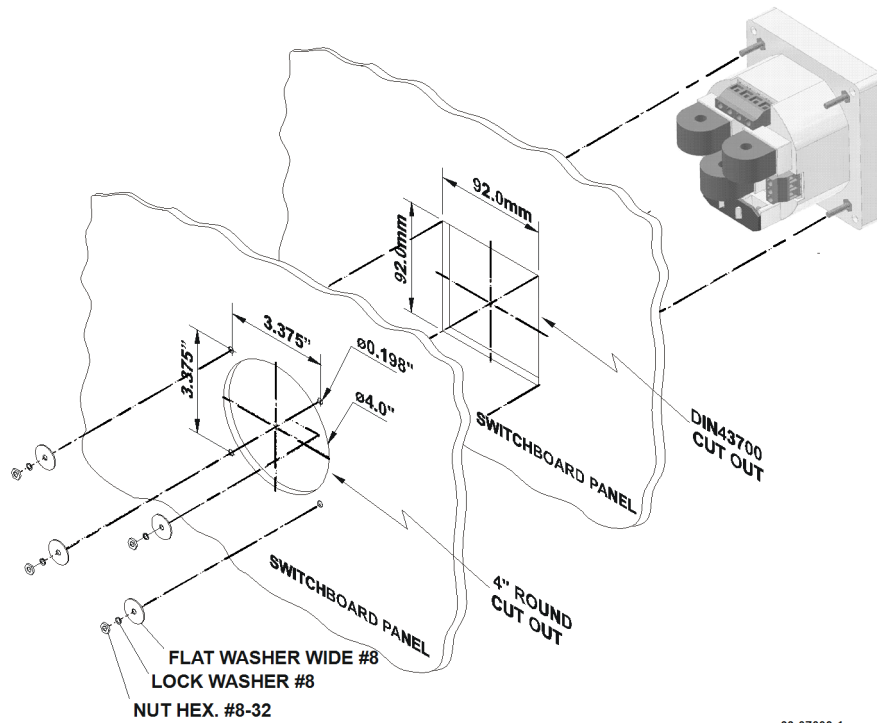

Figure 2-2. Mounting

DIN Rail Mounting

The PM135 can be mounted on a 35-mm DIN rail.

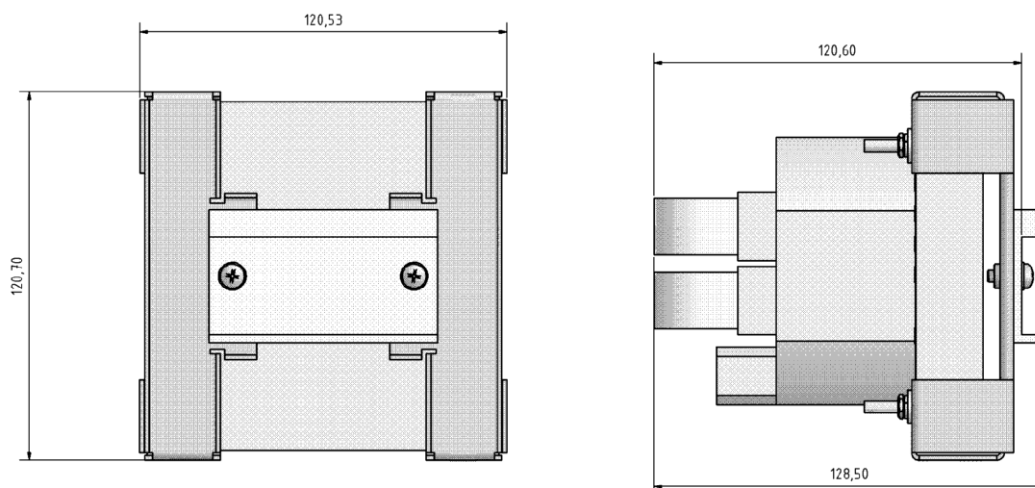

Figure 2-3. Dimensions

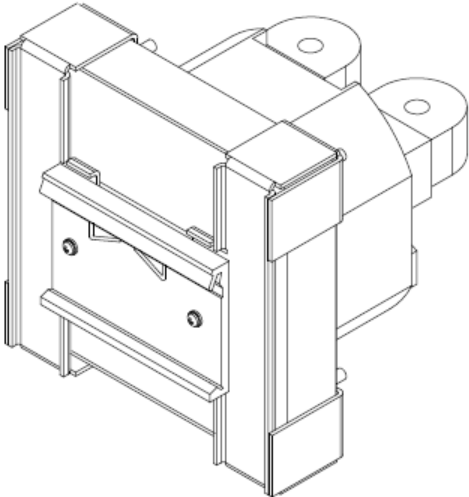

Figure 2-4. DIN Rail Mounting

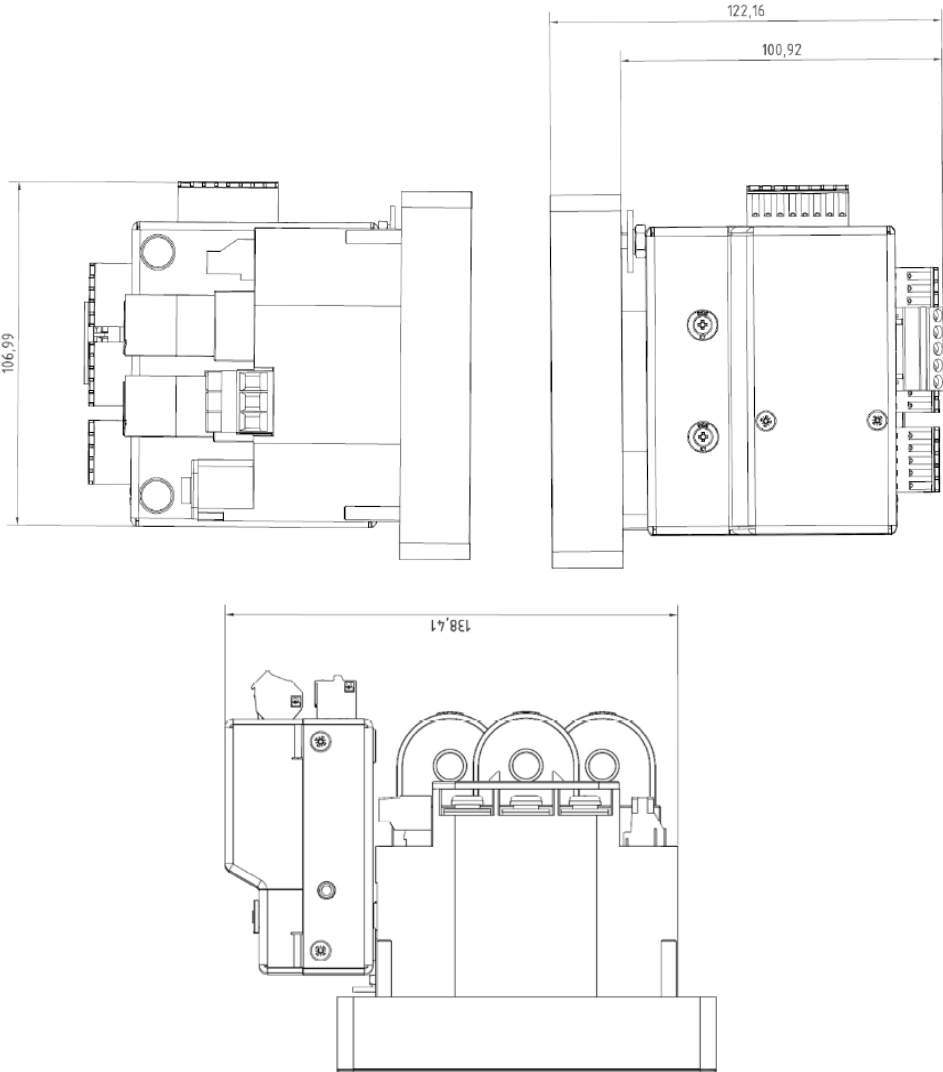

Figure 2-5 PM135 with 12DI/4RO module

2.4 Electrical Installation

The equipment installation shall conform to the following instructions:

- a) a switch or circuit-breaker shall be included in the building installation;
- b) It shall be in close proximity to the equipment and within easy reach of the OPERATOR;
- c) It shall be marked as the disconnecting device for the equipment.



Before installing, ensure that all incoming power sources are shut OFF. Failure to observe this practice can result in serious or even fatal injury and damage to equipment.

Typical Installation

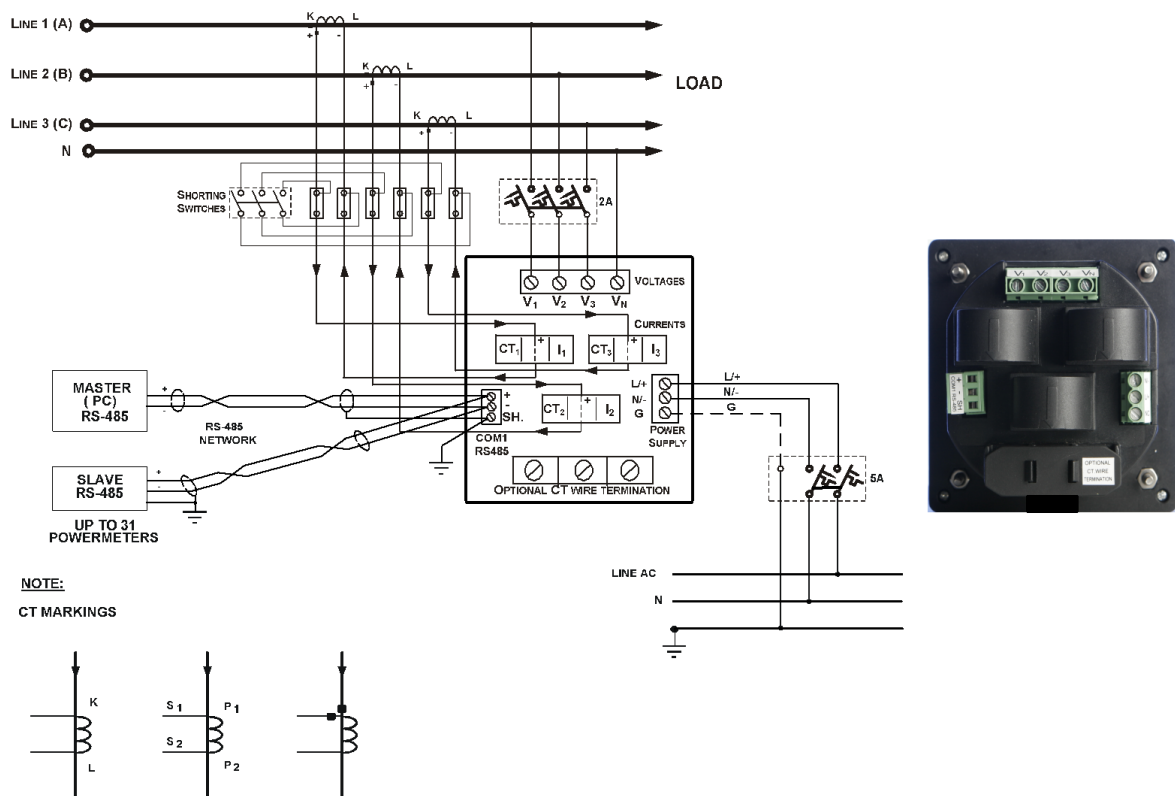

Figure 2-6. Typical Installation Diagram

Terminals



Figure 2-7. Terminals -Rear View

Power Source Connection

The equipment installation shall conform to the following instructions:

a) a switch or circuit-breaker shall be included in the building installation;



b) It shall be in close proximity to the equipment and within easy reach of the OPERATOR;

c) It shall be marked as the disconnecting device for the equipment.

Before installing, ensure that all incoming power sources are shut OFF. Failure to observe this practice can result in serious or even fatal injury and damage to equipment.

The power source can be a dedicated fuse, or a monitored voltage if it is within the instrument power supply range.

To connect an AC power supply:

1. Connect the Line wire to terminal L/+.
2. Connect the Neutral wire to terminal N/-.

To connect to a DC power supply:

1. Connect the positive wire to terminal L/+
2. Connect the negative wire to terminal N/-.

Voltage Input connection

The equipment installation shall conform to the following instructions:



- a switch or circuit-breaker shall be included in the building installation;
- It shall be in close proximity to the equipment and within easy reach of the OPERATOR;
- It shall be marked as the disconnecting device for the equipment.

Before installing, ensure that all incoming power sources are shut OFF. Failure to observe this practice can result in serious or even fatal injury and damage to equipment.

690V Inputs (Standard)

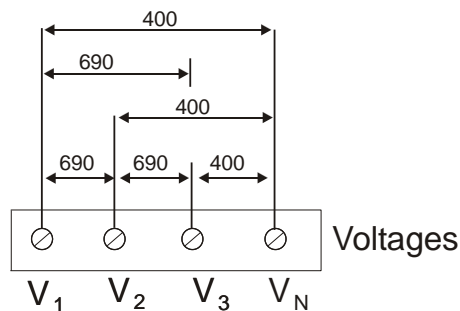

690V inputs are usually used with direct connection. Use any of the seven wiring configurations shown in Figures 2-8 through 2-15.

120V Inputs (Option U)

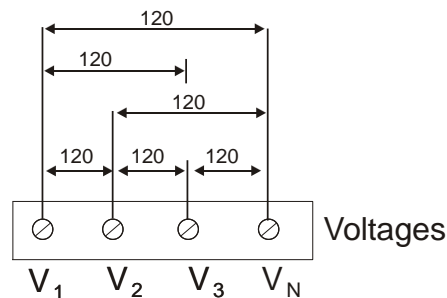

120V inputs usually imply use of a potential transformer (PT). The PT requires use of any of the four wiring configurations shown in Figures 2-7 through 2-10.

Current Input Connection

The PM135 series provide two different CT connections:

- Using internal CT, the PM135 does not have current terminals
- Using external CT (HACS – High Accuracy SATEC Current Sensor), the PM135 provides current terminals

To connect to the external CT, pass the external CT wire through the meter CT core, see Figure 2-8 for details and observe the arrow that indicates the current direction.

In case of a retrofit application where each external CT ends with two wires:

1. Pass one wire through the meter CT core.
2. Connect the wire to one of the meter termination screws.
3. Connect the second wire from the external CT to the termination screw to close the loop.

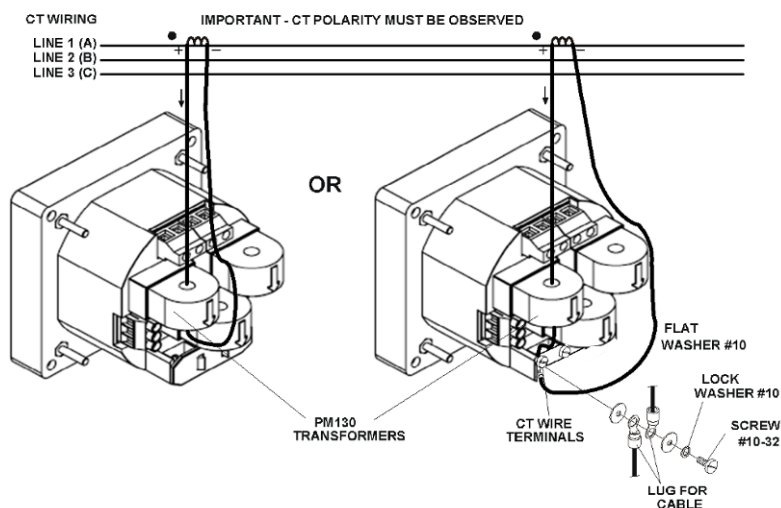

Figure 2-8. Current Input Connection

Wiring Diagrams

For AC input ratings, see [Technical Specifications](#) in Appendix A for more details.

Table 2 presents the available wiring configurations in the meter. For more details, see [Basic Meter Setup](#) in Chapter 5.

Table 2: Wiring Configurations

Wiring Configuration	Setup Code	Figure
3-wire 2-element Delta direct connection using 2 CTs	3dir2	2-8
4-wire 3-element Wye direct connection using 3 CTs	4Ln3 or 4LL3	2-9
4-wire 3-element Wye connection using 3 PTs, 3 CTs	4Ln3 or 4LL3	2-10
3-wire 2-element Open Delta connection using 2 PTs, 2 CTs	3OP2	2-11
4-wire 2½-element Wye connection using 2 PTs, 3 CTs	3Ln3 or 3LL3	2-12
3-wire 2½-element Open Delta connection using 2 PTs, 3 CTs	3OP3	2-13
4-wire 3-element Delta direct connection using 3 CTs	4Ln3 or 4LL3	2-14
3-wire 2½-element Broken Delta connection using 2 PTs, 3 CTs	3bLn3 or 3bLL3	2-15

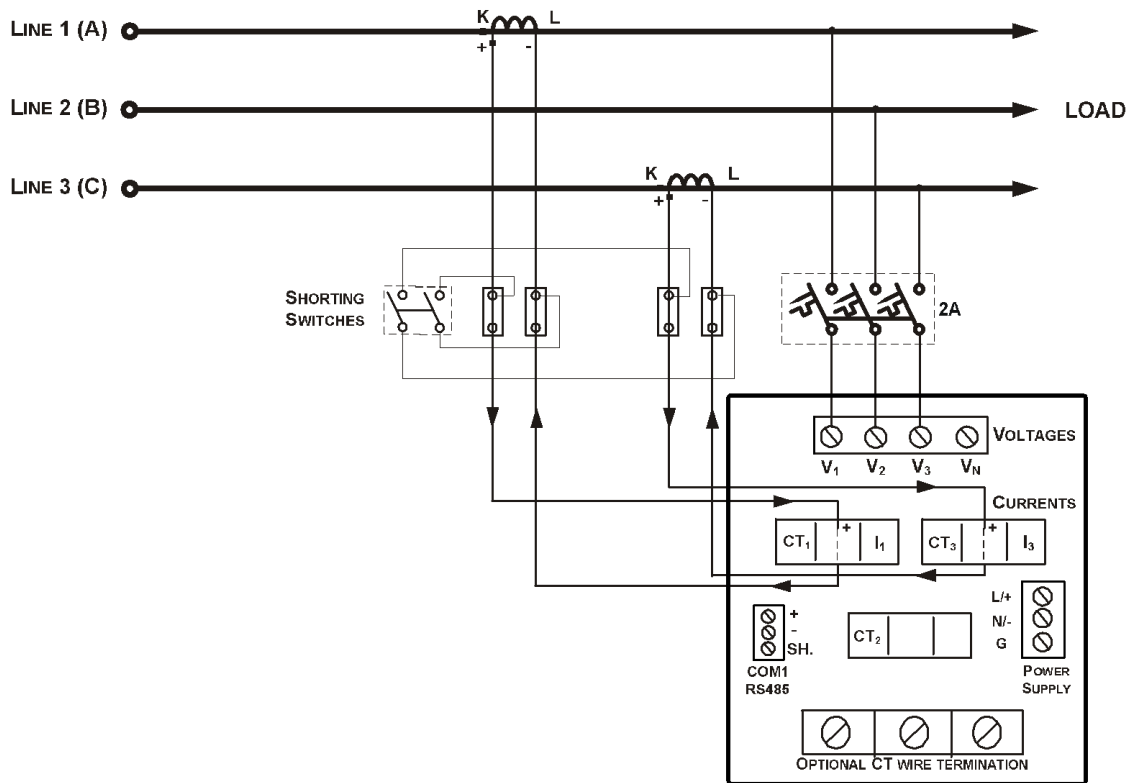

Figure 2-9 3-Wire 2-Element Delta Direct Connection Using 2 CTs (Wiring Mode = 3dir2)

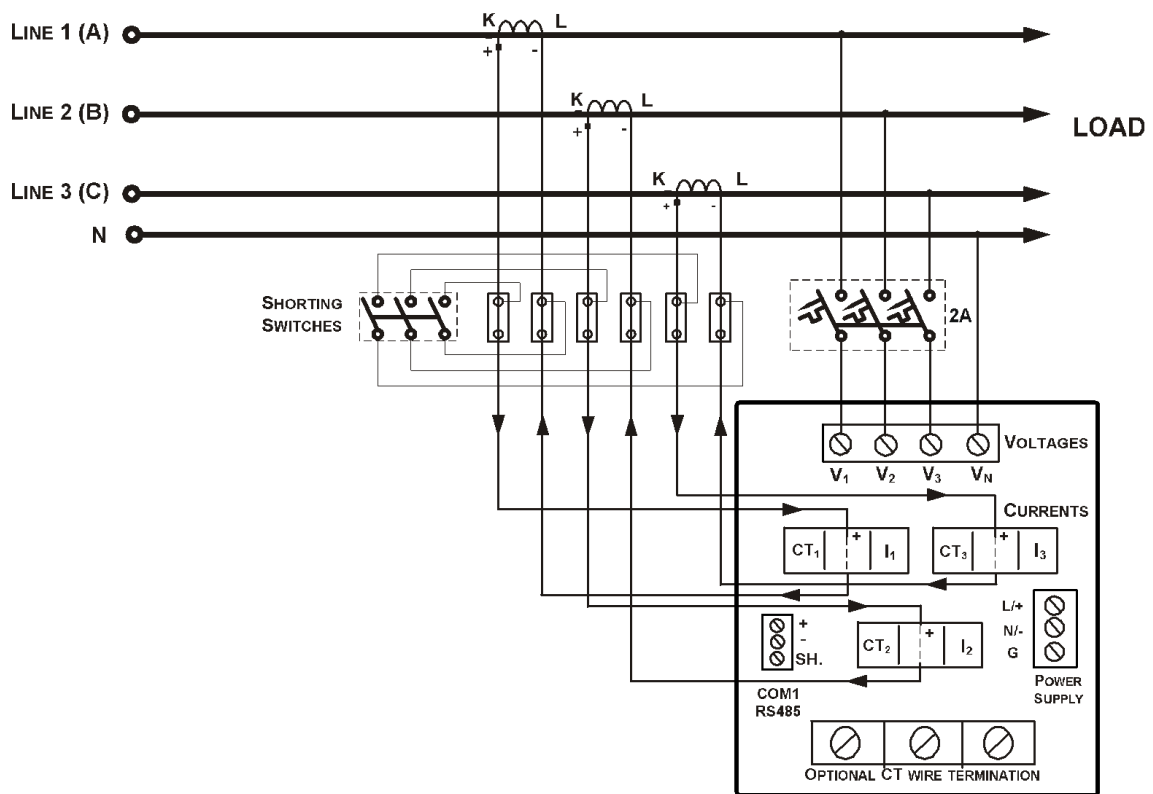

Figure 2-10 4-Wire Wye 3-Element Direct Connection Using 3 CTs (Wiring Mode = 4LL3 or 4Ln3)

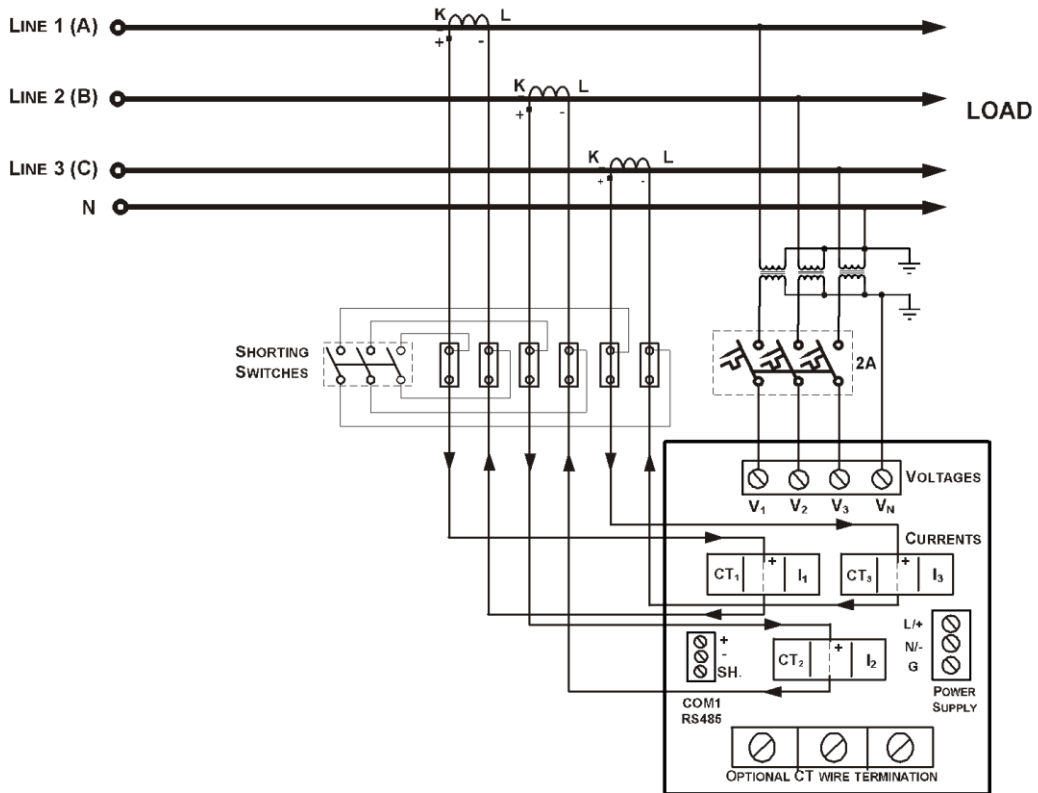

Figure 2-11 4-Wire Wye 3-Element Connection Using 3 PTs, 3 CTs (Wiring Mode = 4LL3 or 4Ln3)

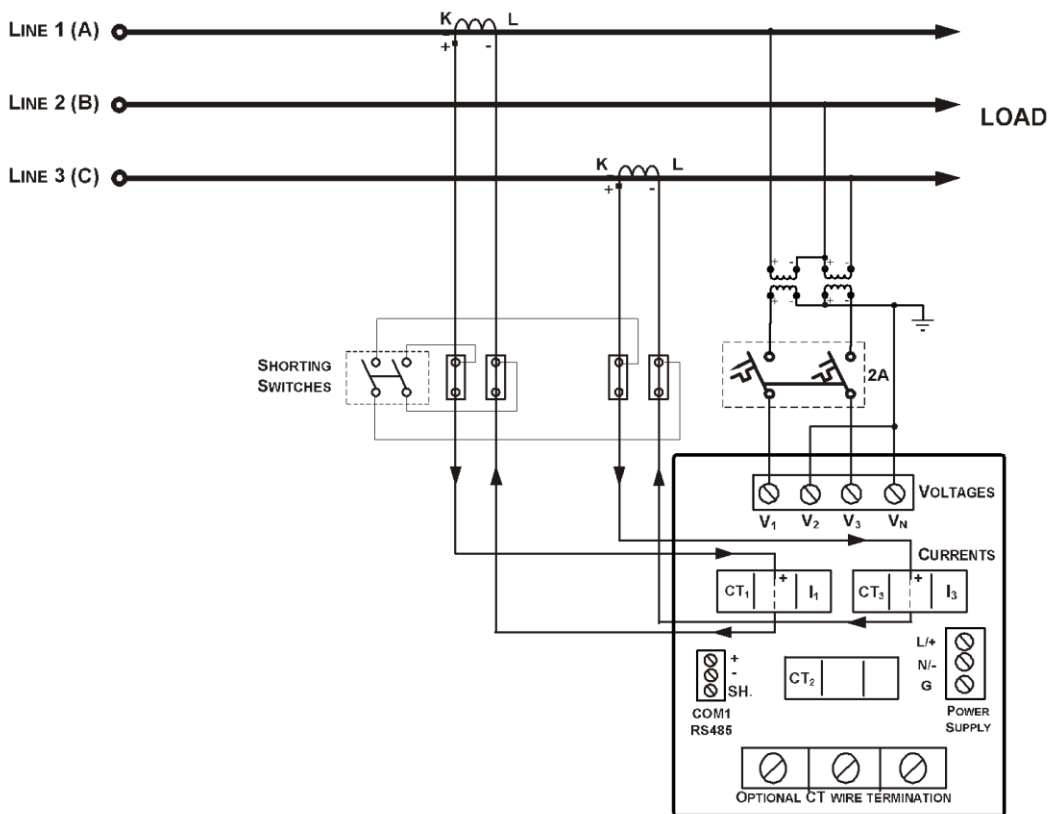
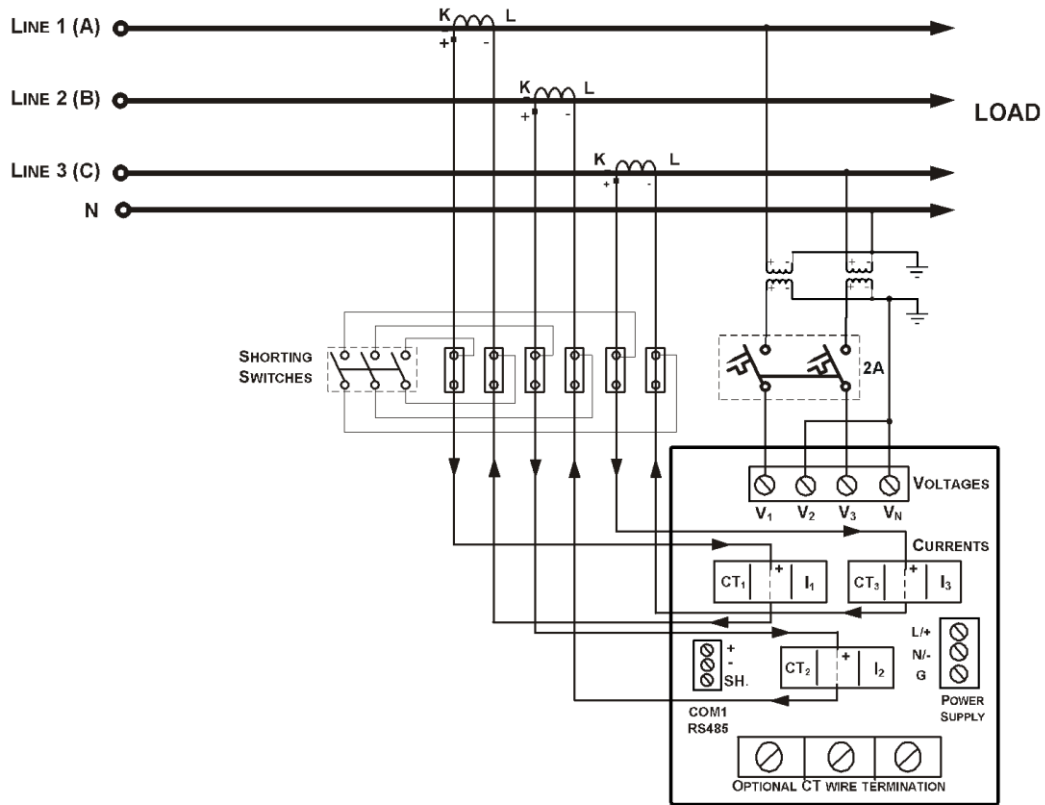

Figure 2-12 3-Wire 2-Element Open Delta Connection Using 2 PTs, 2 CTs (Wiring Mode = 3OP2)



This configuration provides accurate power measurements only if the voltages are balanced.

Figure 2-13 4-Wire Wye 2½-Element Connection Using 2 PTs, 3 CTs (Wiring Mode = 3LL3 or 3Ln3)

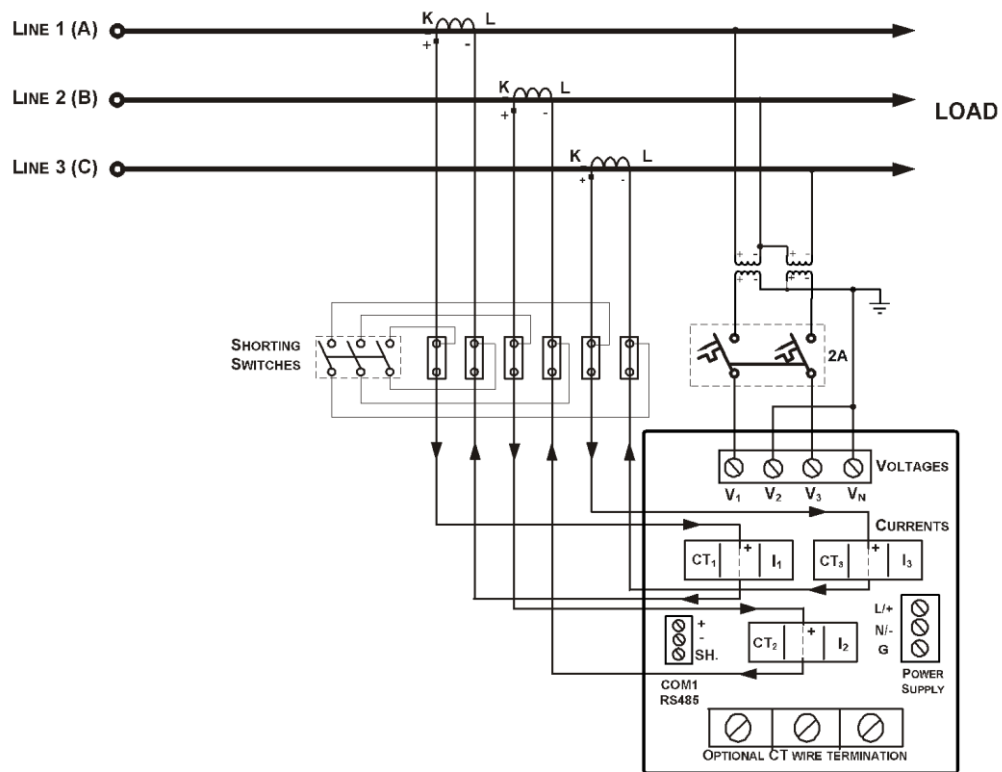

Figure 2-14 3-Wire 2½-Element Open Delta Connection Using 2 PTs, 3 CTs (Wiring Mode = 3OP3)

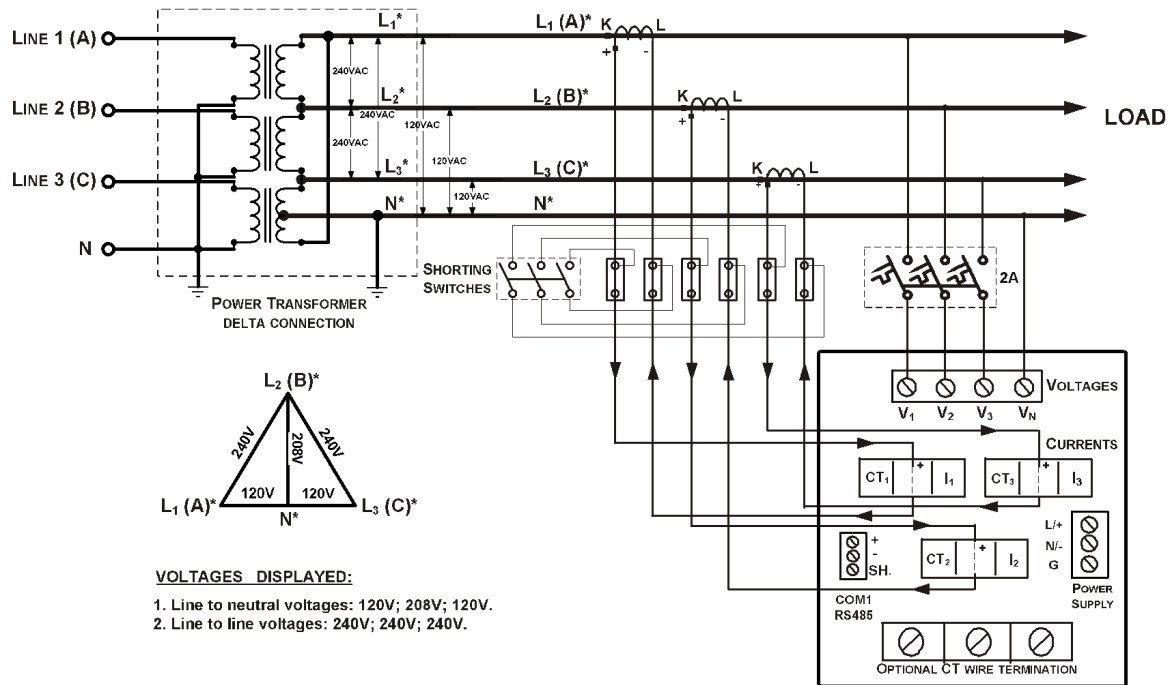

Figure 2-15 4-Wire 3-Element Delta Direct Connection Using 3 CTs (Wiring Mode = 4LL3 or 4Ln3)

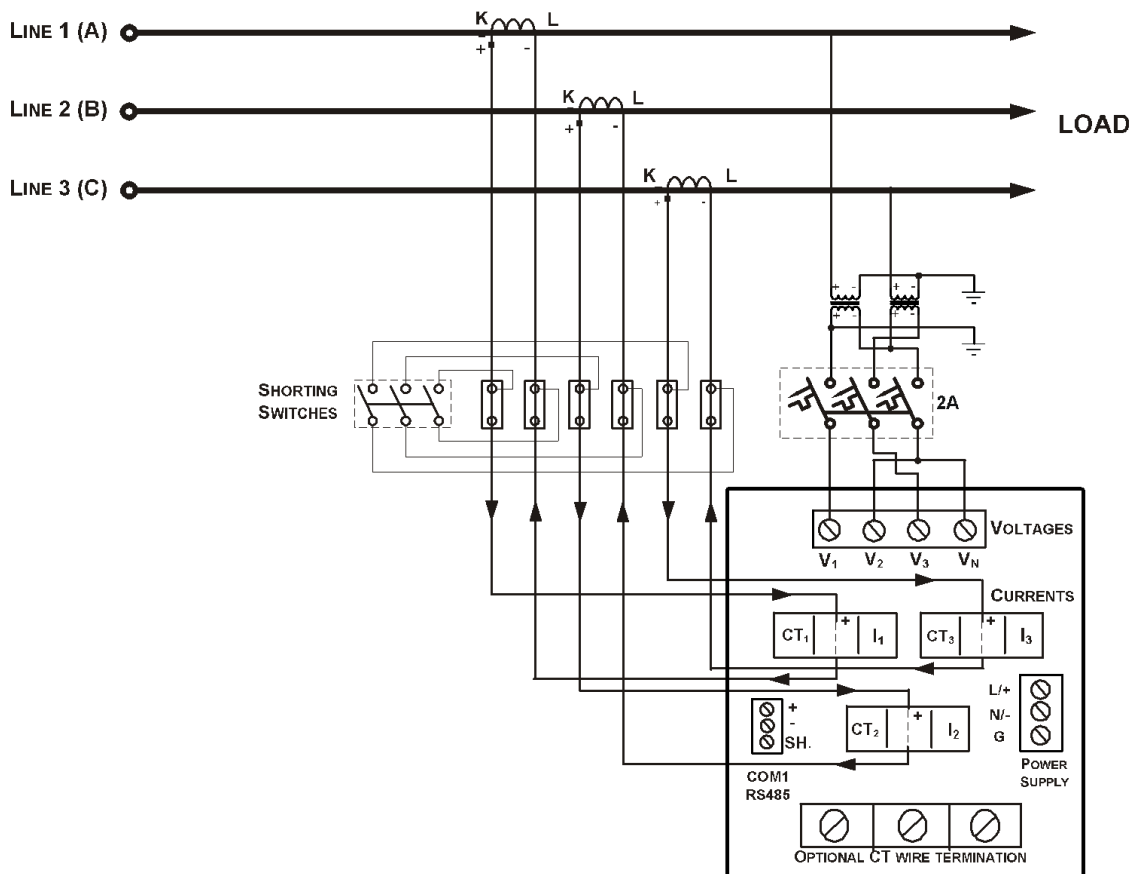

Figure 2-16 3-Wire 2½-Element Broken Delta Connection Using 2 PTs, 3 CTs (Wiring Mode = 3bLn3 or 3bLL3)

2.5 I/O Connections



Before I/O Module installation ensure that all incoming power sources are shut OFF. Failure to observe this practice can result in serious or even fatal injury and damage to equipment.

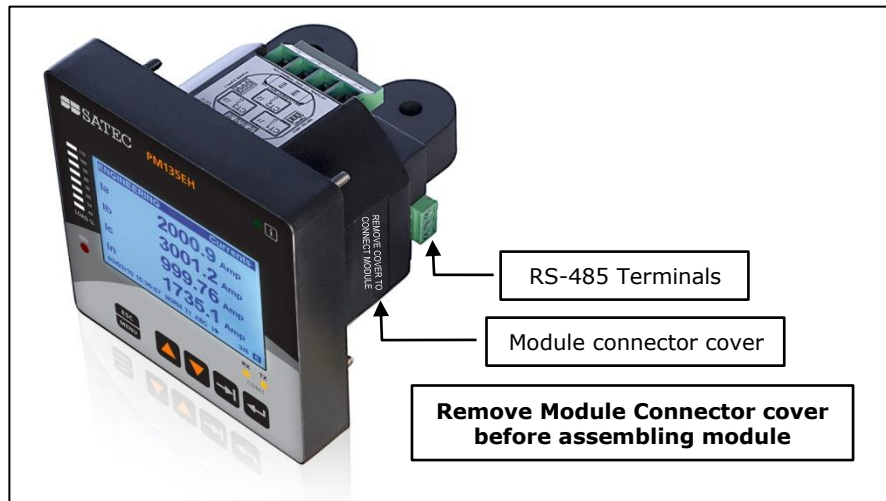

Figure 2-17 Module Connector Cover – Before Module Assembly

For I/O ratings, see [Technical Specifications](#) in Appendix A.

4DI/2DO Module



Figure 2-18 4DI/2DO Module Assembly

Relay Outputs

There are two relay outputs provided for energy pulsing, alarms, or remote control.

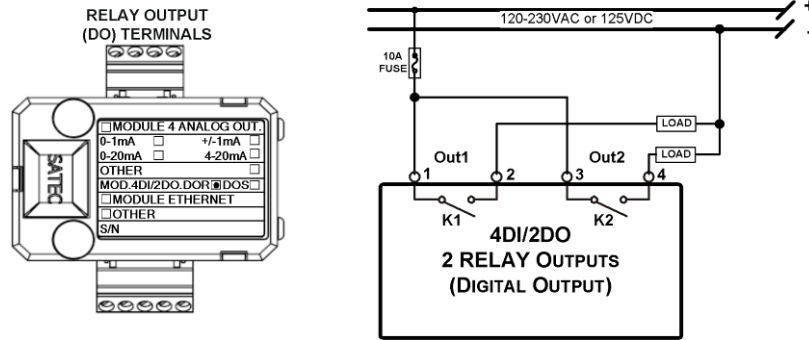

Figure 2-19 Relay Output Connection

Digital Inputs

Four optically isolated status inputs are provided for status monitoring, pulse counting, external power demand period, and time synchronization.

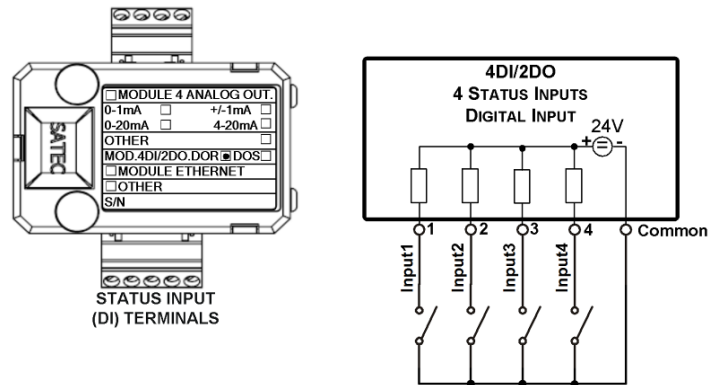

Figure 2-20 Digital Input Connection

12DI/4RO Module

The 12DI/4RO module can be equipped with optional communication port COM2 – ETHERNET or RS-422/485.

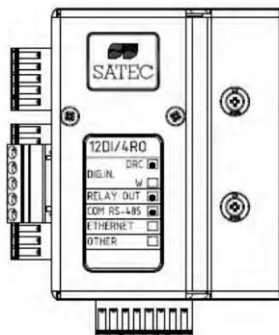

Figure 2-21 12DI/4RO Module



Before I/O Module installation ensure that all incoming power sources are shut OFF. Failure to observe this practice can result in serious or even fatal injury and damage to equipment.

Relay Outputs

There are four electro-mechanic relay outputs provided for energy pulsing, alarms, or remote control.

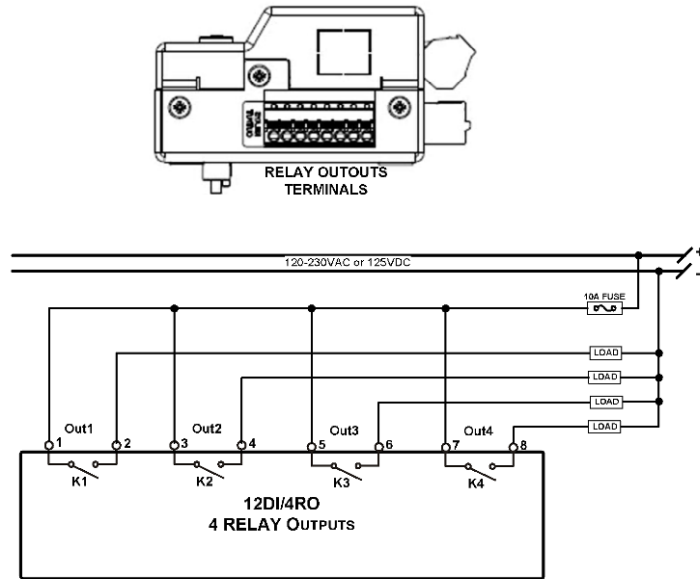

Figure 2-22 Relay Output Connection

Digital Inputs

12 optically isolated status inputs are provided for status monitoring, pulse counting, external power demand period, and time synchronization.

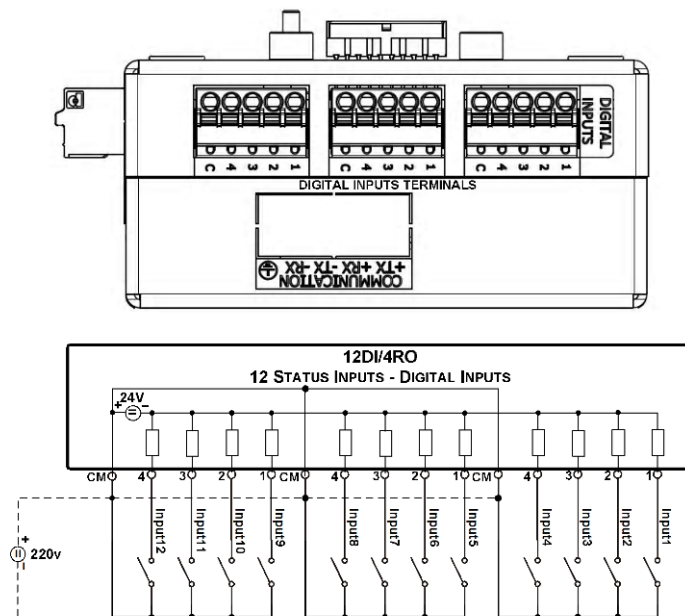

Figure 2-23 12 Digital Input Connection

4AO Module - Analog Outputs

The 4AO module has four optically isolated analog outputs with an internal power supply and current output options of 0-20 mA and 4-20 mA (current loop load of up to 500 Ohm), 0-1 mA and ± 1 mA (2mA 100% overload, current loop load of up to 5 kOhm).

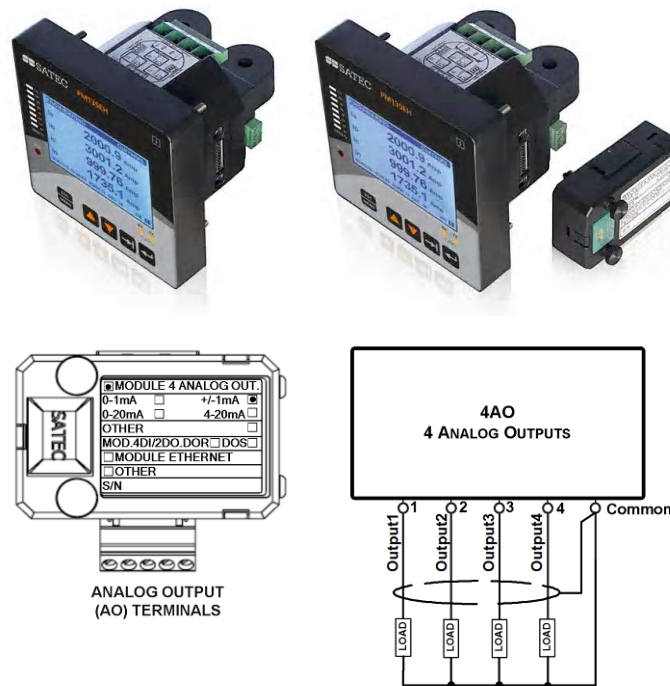

Figure 2-24: Analog Output Connection



It is recommended to connect unused Analog output channels to Common terminal.

- The 4AO module TERMINAL is for use only with equipment which has no live parts which are ACCESSIBLE
- The RATING of the insulation of the external equipment for use with the 4AO module, shall comply according to Installation Category II for insulation to be suitable for SINGLE FAULT CONDITION
- ⇒ • The external equipment TERMINAL connection type is normally terminal block for wire size 14 AWG (up to 1.5 mm²)
- The type of equipment that might be connected to the TERMINAL is:
 - Programmable Logic Controller for automation – PLC
 - Digital or Analog meter

TOU module – RTC and 4 Digital Inputs

The TOU provides a battery-operated real time clock (RTC) with four optically isolated inputs for status monitoring, time synchronization, pulse counting, and external power demand period.

Digital Inputs

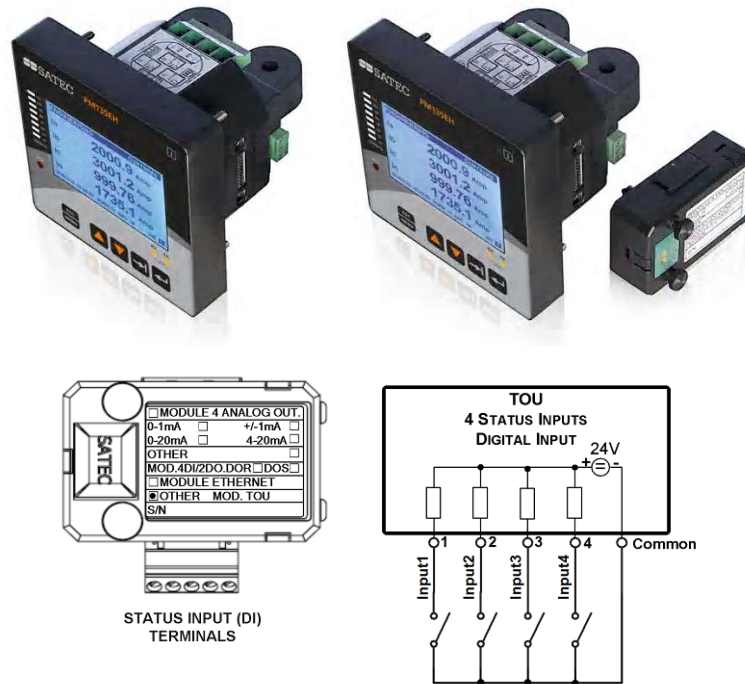

Figure 2-25: TOU Digital Input Connection

TOU – Battery Replacement

WARNING!

Only qualified personnel familiar with the instrument and its associated electrical equipment must perform the RTC battery backup replacement.

To replace the CR1632 RTC battery:

1. Remove the TOU module from the PM135 compartment
2. Open the TOU MODULE case by applying a flat screwdriver at three snap-in slit (1, 2 and 3), as shown in Figure 2-26.
3. Remove the old battery by lifting up the battery holder retractable tab.
4. Place the new CR1632 battery into the battery holder while holding up the battery holder retractable tab in such a way that the (+) battery pole is toward the battery holder, as shown in Figure 2-26.

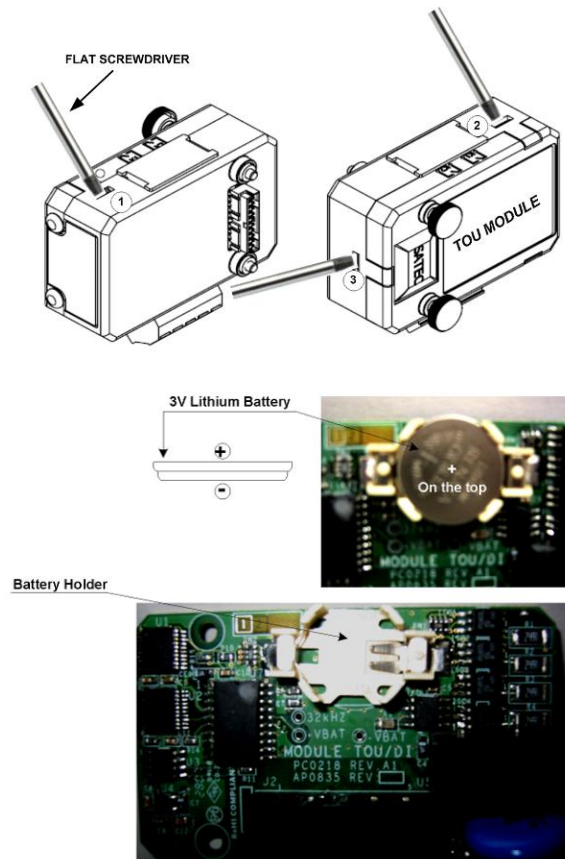

Figure 2-26: TOU RTC Battery Replacement

2.6 Communications Connections



Before installing the Communication Module, ensure that all incoming power sources are shut OFF. Failure to observe this practice can result in serious or even fatal injury and damage to equipment.

Several communication options are available for the PM135:

- **COM1:** RS-485
- **COM2, on optional communication module:**
 - Ethernet 10/100BaseT
 - PROFIBUS DP
 - GPRS
 - RS-232 or RS-422/485
 - RF modem (ISM frequency)

A connection to the Ethernet connector is made through a cable adaptor provided with your meter.

A full description of the communication protocols is found in the PM135 protocol guides that come with your meter.

⇒ The 12DI/4RO module can be equipped with optional communication

port COM2 – ETHERNET or RS-422/485

COM1 RS-485 Connection

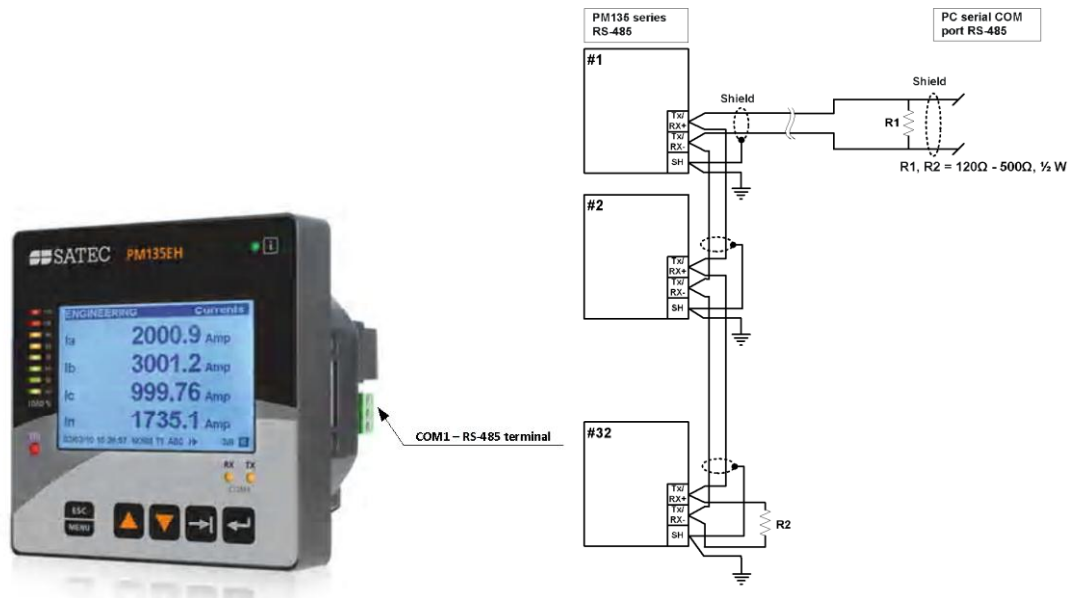

Figure 2-27: COM1 RS-485 2-Wire Connection

The connector is removable with three captured-wire terminals.

ETH module – COM2 Ethernet Connection

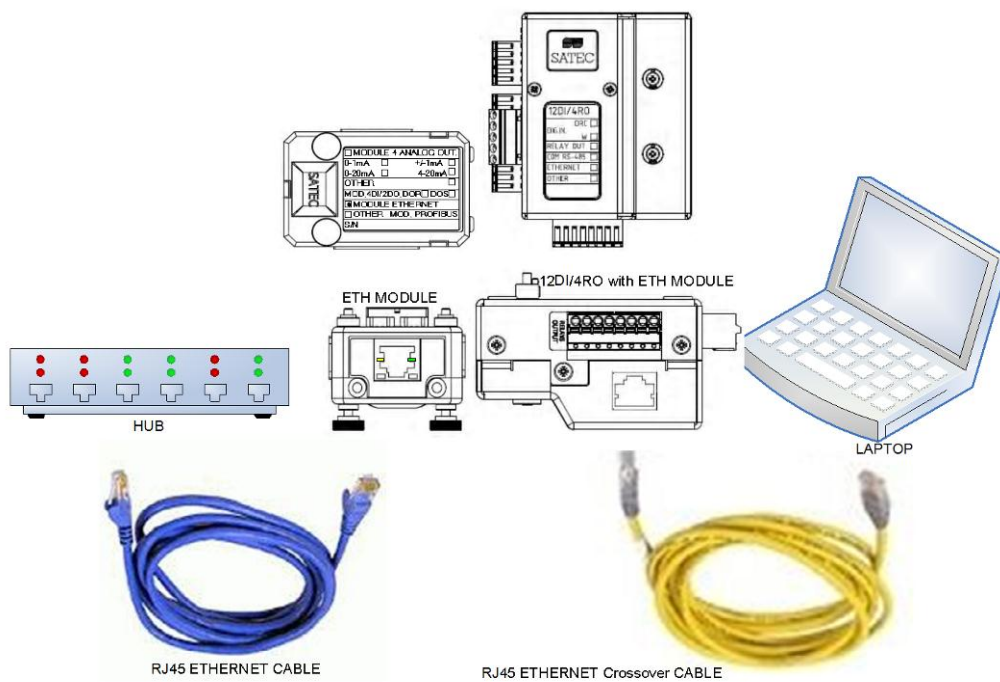

Figure 2-28: COM2 Ethernet Connection

- The ETH module TERMINAL is for use only with equipment which has no live parts which are ACCESSIBLE
 - The RATING of the insulation of the external equipment for use with the ETH module, shall comply according to Installation Category II for insulation to be suitable for SINGLE FAULT CONDITION
- ⇒
- The external equipment TERMINAL connection type is RJ-45
 - The type of equipment that might be connected to the TERMINAL is:
 - Personal Computer – PC or LAPTOP
 - 10/100Base-T LAN HUB and/or Switch

PRO module – COM2 PROFIBUS Connection

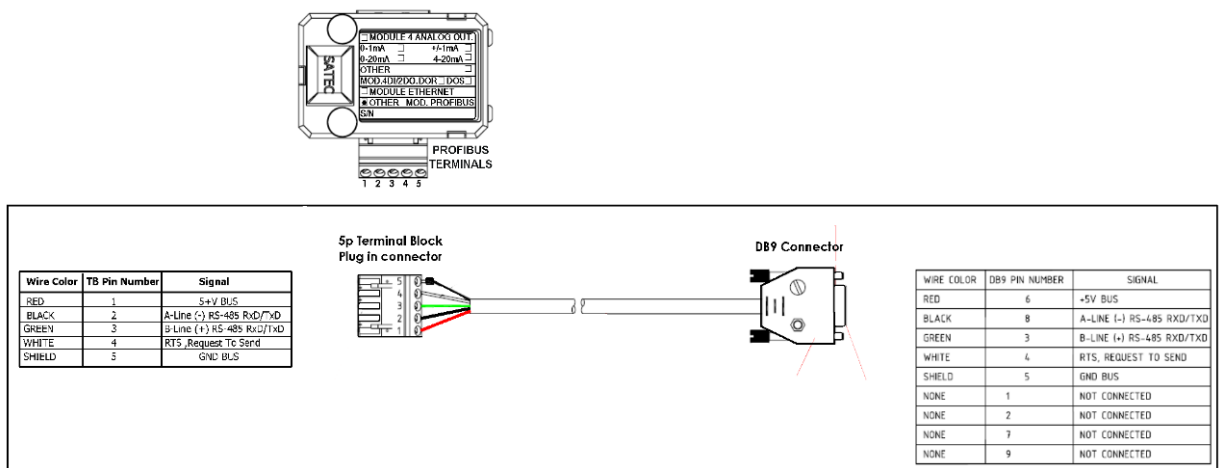

Figure 2-29: COM2 PROFIBUS Connection

- The PRO module TERMINAL is for use only with equipment which has no live parts which are ACCESSIBLE
 - The RATING of the insulation of the external equipment for use with the PRO module, shall comply according to Installation Category II for insulation to be suitable for SINGLE FAULT CONDITION
- ⇒
- The external equipment TERMINAL connection type is DB9
 - The type of equipment that might be connected to the TERMINAL is:
 - Programmable Logic Controller for automation – PLC

RS-232/422-485 module – COM2 Connection

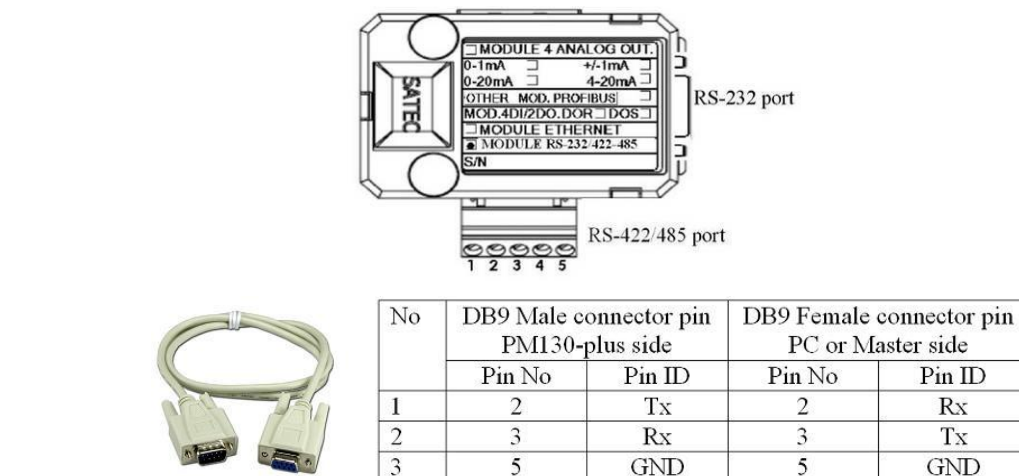

Figure 2-30: COM2 RS-232 connection

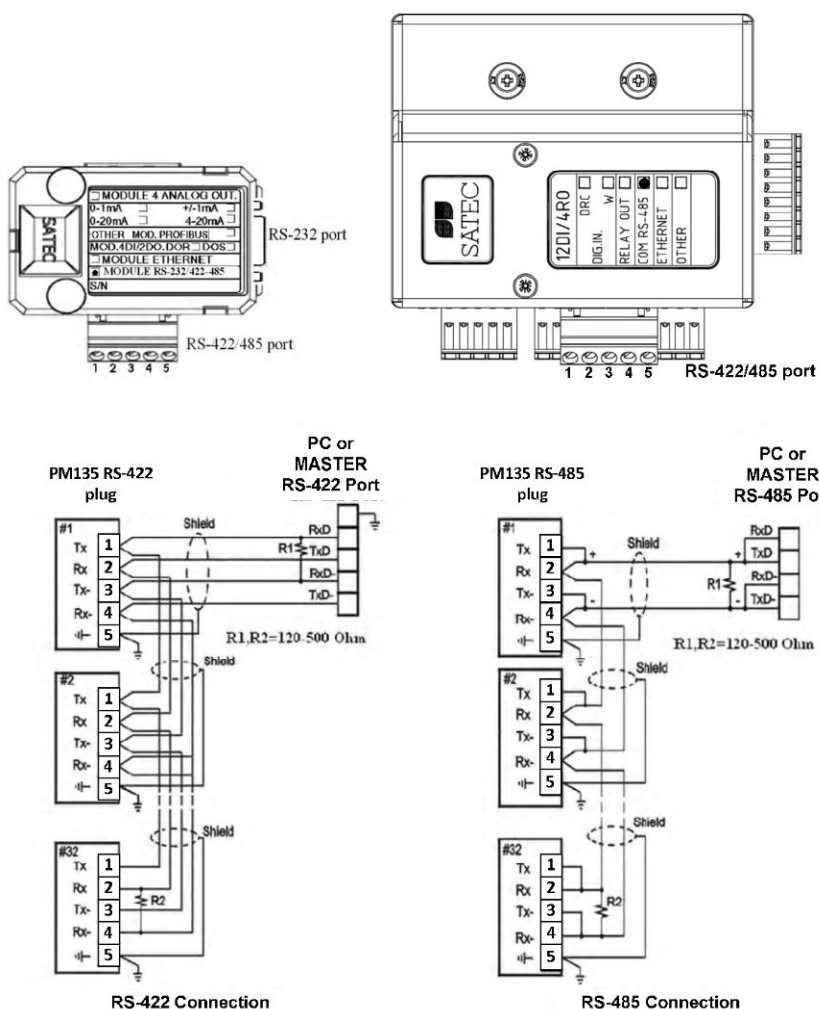

Figure 2-31: COM2 RS-422/485 and 12DI/4RO-RS-422/485 modules connection

- The RS-232/422-485 module TERMINALS are for use only with equipment which has no live parts which are ACCESSIBLE
 - The RATING of the insulation of the external equipment for use with The RS-232/422-485 module, shall comply according to Installation Category II for insulation to be suitable for SINGLE FAULT CONDITION
- ⇒
- The external equipment TERMINAL connection type is normally terminal block for wire size 14 AWG (up to 1.5 mm²) – RS-422/485 port and DB9 male-to-female cable more than 22 AWG (0.3mm²)
 - The type of equipment that might be connected to the TERMINAL is:
 - Personal Computer – PC or LAPTOP

GPRS/GSM modem module – COM2 GPRS connection

A GSM/GPRS modem module can be connected to the meter COM2 port to provide communications with the remote MODBUS/TCP server via a wireless GPRS network.

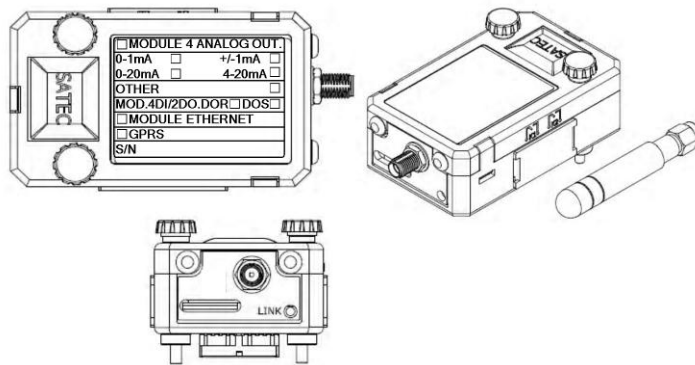

Figure 2-32: GSM/GPRS modem Module

- ⇒ The GSM/GPRS SIM must not have any incoming voice call. The customer must require from the Service Provider for DATA services only
- ⇒ The GPRS modem module can be equipped with two different antennas: internal Antenna for installation into plastic closet or no-metallic environment. For metallic installation use external antenna

See [Setting Up GPRS Network](#) in Chapter 5 for information on configuring GPRS communications in your meter.

Chapter 3 Using Front Display

This chapter provides PM135 Power meter series front panel information and operating procedures.

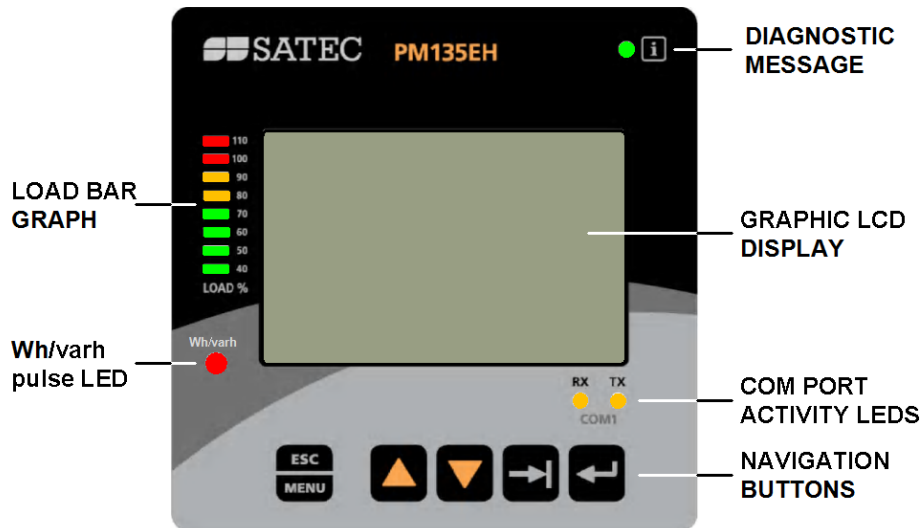

Figure 3-1: PM135 Unit

3.1 Display Operations

The PM135 has a high-contrast graphical LCD display with backlight for local data read outs, meter setup and servicing.





The display operates in two modes:

- Multi-page data display mode with Auto-Scroll feature allows you to scroll through display screens and pages to view various billing, instrumentation and status data.
- Programming mode allows you to enter menu-driven device setups for inspecting and changing factory set meter parameters, or resetting maximum demands, counters and device diagnostics messages.

The display is normally updated once per second.

Navigation Buttons

The PM135 is provided with five navigation buttons as described below:

Button	Operation
	SELECT/ENTER
	TAB - browse from submenu to next submenu or move to required digit setup
	PAGE DOWN- scrolling DOWN
	PAGE UP - scrolling UP
	ESCAPE

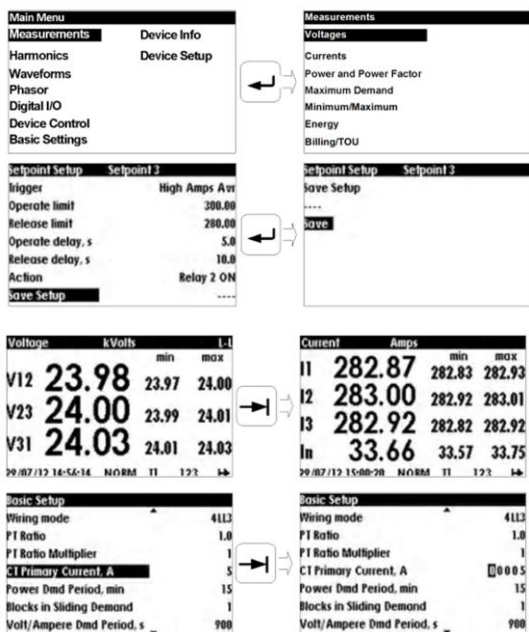



The **SELECT/ENTER** button -  function changes depending on the display mode:

- While navigating to submenus, pressing the **SELECT/ENTER** button selects the highlighted line menu
- In "Basic Setup" or "Device Setup" menus, while changing device parameters pressing the **SELECT/ENTER** button stores the parameter changes into the device

The **TAB** button -  function changes depending on the current display:

- In display data mode - monitoring, pressing the **TAB** button moves from current data display to next data display
- For instance, in "Basic Setup" selecting "CT Primary Current A", pressing the **TAB** button moves to next digit to be set

The **UP/DOWN scroll** buttons -   function changes depending on the current display:

- In display menu mode - pressing the **UP/DOWN scroll** buttons, navigates between each function/parameter in menu screens
- In display data mode - pressing the **UP/DOWN scroll** buttons, navigates from current display data screen to next display data screen

The **ESC/MENU** button -  function changes depending on the current display:

- In display menu mode - while in sub-menu, pressing the **ESC/MENU** button, moves to upper menu screen
- In display data mode - pressing the **ESC/MENU** button, moves to Main Menu screen

Navigating in Data Display Mode

The PM135 provides multiple pages data displays. Your present location is indicated upper bar as shown in the following picture. See [Data Displays](#) for the full displays list.

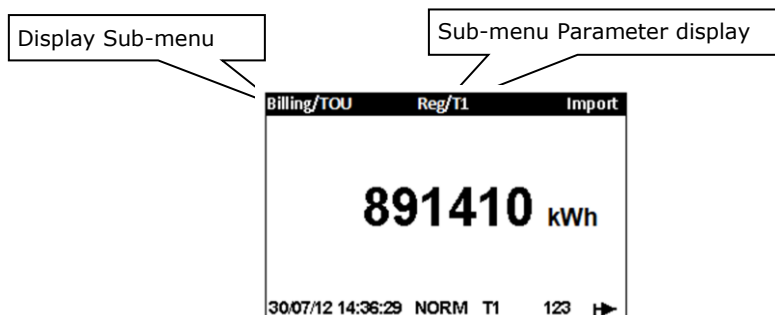

Use **UP/DOWN scroll** buttons to scroll through data displays.

Status Indicators

Graphical icons on the bottom status bar give immediate meter status indication and show the present tariff rate.

The present date and time are indicated at left on the status bar. The date order can be changed according to local rules via the "Real Time Clock" device setup menu.

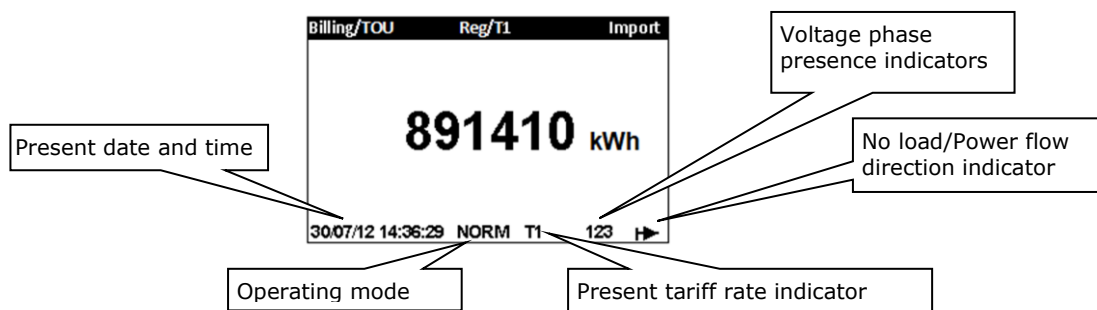

Operating Mode Indicator

The mode indicator gives information on the load presence and shows the direction of active power.

Indicator Icon	Description
NORM	Normal mode
TEST	Test mode

Tariff Rate Indicator

The tariff rate indicator (T1 through T8) shows the currently active tariff rate.

No Load/Power Flow Direction Indicator

The power flow indicator gives information on the load presence and shows the direction of active power.

Indicator Icon	Description
⊗	No load.

➔	Direct active power flow – delivered active energy.
➠	Reversed active power flow – received active energy.

Phase Presence Indicators

Phase presence indicators “123” show the status of either V1-V2-V3 phase-to-neutral voltages in line-to-neutral wiring modes, or V12-V23-V31 phase-to-phase voltages in line-to-line wiring modes.

Indicator Icon	Description
123	All voltages are present and above the voltage dip threshold.
1 3 123	Blinking phase indicator – the phase voltage is below the defined voltage dip threshold. Possibly indicates an incorrect meter nominal voltage setting (see Basic Meter Setup in Chapter 5).
1-3	Dashed phase indicator - the phase voltage is either missing or below the voltage interruption threshold.

If the phase voltage is below the defined voltage dip threshold, its corresponding phase indicator is blinking.

If the phase voltage is either missing or below the voltage interruption threshold, the phase indicator is replaced with a dash

Display Features

While energizing the device the display will show an init screen followed by phase-voltages measurements as described below:

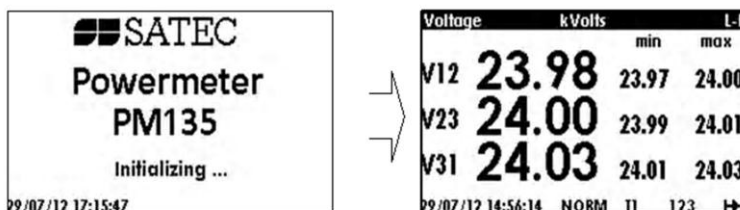

The PM135 display has a number of programmable features that can be disabled, enabled and adjusted via the meter Display Setup (see [Display Setup](#) in Chapter 5).

Backlight

A short press on any button while the display backlight is off switches the backlight on.

The backlight stays on as long as you selected in the display setup and then dims to conserve power. The backlight time is factory set to 1 minute and can be programmed from 1 to 10 minutes. You can temporarily set the backlight to continuous operation if you need to work in dark for more time.

Contrast

The contrast can be adjusted via the meter Display Setup (see [Display Setup](#) in Chapter 5).

Auto-Return

If the Auto-Return feature is enabled and no button is pressed for the programmable Auto-Return interval (1 to 30 minutes for data displays;

fixed at 5 minutes for setup menus), the display automatically returns to the default page from any other data display or a setup menu.

If the Auto-Scroll feature is enabled, the display immediately enters the auto scroll sequence.

Auto-Scroll

If the Auto-Scroll feature is enabled, the data display automatically scrolls through all pages of all data displays that are included into the programmable auto-scroll sequence. The scroll interval is adjustable in the range of 2 to 30 seconds. The scroll sequence may include all or only selected displays.

The display automatically enters auto scrolling if no button is pressed for the Auto-Return interval when the Auto-Return feature is enabled or in 1 minute if this feature is disabled. In the last case, the scroll sequence is restored from the point where it was interrupted.

To stop auto scrolling, press briefly any button if the backlight is on; else press briefly any button twice since the first press only sets the backlight on and does not affect auto scrolling.

Auto-Scroll is not operational in TEST mode.

Measurement Units

The PM135 has a selectable resolution for volts, amps and powers presented on the front display and via communications. See [Device Options](#) in Chapter 5 for information on selecting the data resolution in the PM135 .

Low Resolution Option

Currents are displayed in whole amperes below 10,000 A, and in kilo amperes above 10,000 A.

Measurement units for voltage and power depend on the voltage connection scheme:

- For direct wiring (PT=1) or wiring via PT with the PT ratio up to and including 4.0, voltages are displayed in volts, and power in kilowatts.
- For the PT ratio above 4.0, voltages are displayed in kilovolts with three decimal places, and power in megawatts with three decimal places.

High Resolution Option

Currents are displayed in amperes with up to two decimal places below 10,000 A, and in kilo amperes above 10,000 A.

Measurement units for voltage and power depend on the voltage connection scheme:

- When direct wiring is used (PT=1), voltages are displayed in volts with one decimal place, and power in kilowatts with three decimal places.
- When wiring via PT is used with the PT ratio up to and including 4.0, voltages are displayed in volts, and power in whole kilowatts.
- For the PT ratio above 4.0, voltages are displayed in kilovolts with three decimal places, and power in megawatts with three decimal places.

The small round "Kilo" and "Mega" LEDs light up showing the appropriate measurement units for a displayed page.

Primary and Secondary Volts

Volts can be displayed in primary (default) or secondary units. The volts display mode can be changed through the display setup (see [Configuring the Display](#)).

Phase Power Readings

In configurations with the neutral wire, in addition to total three-phase powers, the meter can show per-phase power readings. By default, they are disabled. See [Configuring the Display](#) on how to enable per-phase power readings in your meter.

Fundamental Component

The PM135EH can display total displacement power factor and active power for the fundamental component if it is enabled through the display setup (see [Configuring the Display](#)).

When phase power readings are allowed, the PM135EH also displays per-phase displacement power factor and active power for the fundamental component.

3.2 Data Displays

The PM135 has 8 multi-page data displays listed in the following table.

Main Menu	
Measurements	Device Info
Harmonics	Device Setup
Waveforms	
Phasor	
Digital I/O	
Device Control	
Basic Settings	

Data Display Menu Sequence	Display Label	Display Contents
1	Measurements	Present 7 Measurements Data Displays: V, I, P, S, Q, PF, Max. DMD, MIN/MAX, Energy and Billing/TOU
2	Harmonics	V/I individual harmonics and Harmonics Spectrum
3	Waveforms	Vn/In Waveforms with THD value
4	Phasor	Voltage and current phasors diagram
5	Digital I/O	Status of counters, Digital IN and relays out
6	Device Control	Diagnostics and Alarms displays
7	Basic Settings	Device configuration display
8	Device Info	Device model, identification, firmwares version, COM1,COM2

TEST Mode Data Display

The TEST data display is shown in TEST mode in place of the billing period data displays.

<table border="1"> <thead> <tr> <th>Energy</th> <th>Total Import</th> </tr> </thead> <tbody> <tr> <td>335510 kWh</td> <td></td> </tr> <tr> <td>220 kvarh</td> <td></td> </tr> <tr> <td>336000 kVAh</td> <td></td> </tr> <tr> <td colspan="2">30/07/12 14:36:29 TEST T1 123 ▶</td> </tr> </tbody> </table>	Energy	Total Import	335510 kWh		220 kvarh		336000 kVAh		30/07/12 14:36:29 TEST T1 123 ▶		<p>TEST mode display: test LED pulse rate in secondary Wh/imp; test kWh and kvarh energy readings in primary units with an extended 0.001 kWh resolution.</p> <p>TEST mode setup menu is enabled in Device Setup/Device Options menu.</p>
Energy	Total Import										
335510 kWh											
220 kvarh											
336000 kVAh											
30/07/12 14:36:29 TEST T1 123 ▶											

Billing Period Data Displays

The PM135 provides billing period data displays for energy and general purpose volume data as m³, cf or Ccf calculated using Digital Input for water and/or gas meter application.

Only registers you selected in the billing/TOU register setup and tariff rates listed in the TOU daily profiles are included (see [Configuring Billing/Tariff Registers](#) and [Configuring the Daily Tariff Schedule](#) in Chapter 5).

The following example demonstrates the present billing period displays for two configured billing registers (kWh imported and kvarh imported) and for three active tariff rates. The actual register contents in your installation may be different depending on your selection of register sources.

Each billing period display lists all total and tariff energy, maximum demand and cumulative maximum demand registers for all configured billing registers and all active tariffs. Use the UP/DOWN button to scroll to the desired Billing/TOU period register display

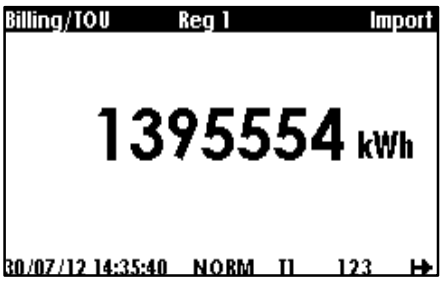
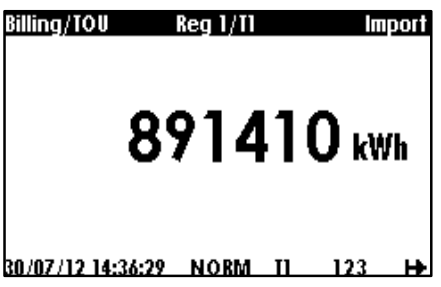
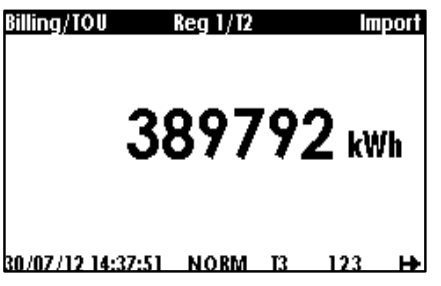
 <p>Billing/TOU Reg 1 Import 1395554 kWh 30/07/12 14:35:40 NORM T1 123</p>	<p>Register 1 - total readings: Total Import Active energy data. Billing period according to TOU predefined profile (Reg1 for TOU active energy and Reg2 for TOU reactive energy are predefined TOU/Register factory setup, can be changed by user, see Configuring Billing/Tariff Registers and Configuring the Daily Tariff Schedule in Chapter 5)</p>
 <p>Billing/TOU Reg 1/T1 Import 891410 kWh 30/07/12 14:36:29 NORM T1 123</p>	<p>Register 1 – tariff 1 readings: Total Import Active energy data.</p>
 <p>Billing/TOU Reg 1/T2 Import 389792 kWh 30/07/12 14:37:51 NORM T3 123</p>	<p>Register 1 – tariff 2 readings: Total Import Active energy data.</p>

<p>Billing/TOU Reg 1/T3 Import</p> <p style="text-align: center;">114352 kWh</p> <p>30/07/12 14:38:03 NORM T3 123 →</p>	<p>Register 1 – tariff 3 readings: Total Import Active energy data.</p>
<p>Billing/TOU Reg 2 Export</p> <p style="text-align: center;">88878 kWh</p> <p>30/07/12 14:36:00 NORM T1 123 →</p>	<p>Register 2 - total readings: Total Export Active energy data.</p>
<p>Billing/TOU Reg 2/T1 Export</p> <p style="text-align: center;">53536 kWh</p> <p>30/07/12 14:36:52 NORM T1 123 →</p>	<p>Register 2 – tariff 1 readings: Total Export Active energy data.</p>
<p>Billing/TOU Reg 2/T2 Export</p> <p style="text-align: center;">14186 kWh</p> <p>30/07/12 14:38:16 NORM T3 123 →</p>	<p>Register 2 – tariff 2 readings: Total Export Active energy data.</p>
<p>Billing/TOU Reg 2/T3 Export</p> <p style="text-align: center;">21156 kWh</p> <p>30/07/12 14:38:29 NORM T3 123 →</p>	<p>Register 2 – tariff 3 readings: Total Export Active energy data.</p>
<p>Billing/TOU Reg 3 Import</p> <p style="text-align: center;">688 kvarh</p> <p>30/07/12 14:36:11 NORM T1 123 →</p>	<p>Register 3 - total readings: Total Import Reactive energy data</p>

<p>Billing/TOU Reg 3/T1 Import</p> <p style="text-align: center;">410 kvarh</p> <p>30/07/12 14:37:00 NORM T1 123 →</p>	<p>Register 3 – tariff 1 readings: Total Import Reactive energy data.</p>
<p>Billing/TOU Reg 3/T2 Import</p> <p style="text-align: center;">110 kvarh</p> <p>30/07/12 14:38:41 NORM T3 123 →</p>	<p>Register 3 – tariff 2 readings: Total Import Reactive energy data.</p>
<p>Billing/TOU Reg 3/T3 Import</p> <p style="text-align: center;">168 kvarh</p> <p>30/07/12 14:38:53 NORM T3 123 →</p>	<p>Register 3 – tariff 3 readings: Total Import Reactive energy data.</p>
<p>Billing/TOU Reg 4 Export</p> <p style="text-align: center;">10561 kvarh</p> <p>30/07/12 14:36:19 NORM T1 123 →</p>	<p>Register 4 - total readings: Total Export Reactive energy data</p>
<p>Billing/TOU Reg 4/T1 Export</p> <p style="text-align: center;">6759 kvarh</p> <p>30/07/12 14:37:09 NORM T1 123 →</p>	<p>Register 4 – tariff 1 readings: Total Export Reactive energy data.</p>
<p>Billing/TOU Reg 4/T2 Export</p> <p style="text-align: center;">2939 kvarh</p> <p>30/07/12 14:39:02 NORM T3 123 →</p>	<p>Register 4 – tariff 2 readings: Total Export Reactive energy data.</p>

<table border="1" style="width: 100%; border-collapse: collapse;"> <tr> <td style="background-color: black; color: white; padding: 2px;">Billing/TOU</td> <td style="background-color: black; color: white; padding: 2px;">Reg 4/T3</td> <td style="background-color: black; color: white; padding: 2px;">Export</td> </tr> <tr> <td colspan="3" style="text-align: center; padding: 20px;">863 kvarh</td> </tr> <tr> <td colspan="3" style="font-size: small; padding: 2px;">30/07/12 14:39:15 NORM T3 123 ⇄</td> </tr> </table>	Billing/TOU	Reg 4/T3	Export	863 kvarh			30/07/12 14:39:15 NORM T3 123 ⇄			Register 4 – tariff 3 readings: Total Export Reactive energy data.
Billing/TOU	Reg 4/T3	Export								
863 kvarh										
30/07/12 14:39:15 NORM T3 123 ⇄										

Measurements Maximum Demand Data Display

Maximum demand displays show measurements maximum demands (not billing maximum demands) for powers, voltages, currents and total harmonics. Each quantity is displayed with the date and time of the last update. Use the UP/DOWN button to scroll to the desired Max. DMD data display

<table border="1" style="width: 100%; border-collapse: collapse;"> <tr> <td style="background-color: black; color: white; padding: 2px;">Max. Demand</td> <td style="background-color: black; color: white; padding: 2px;">Power Import</td> </tr> <tr> <td style="padding: 2px;">P 11.25 MW</td> <td style="padding: 2px;">29/07/12 14:30:00</td> </tr> <tr> <td style="padding: 2px;">Q 3.590 Mvar</td> <td style="padding: 2px;">29/07/12 14:57:00</td> </tr> <tr> <td style="padding: 2px;">S 11.64 MVA</td> <td style="padding: 2px;">29/07/12 14:30:00</td> </tr> <tr> <td colspan="2" style="font-size: small; padding: 2px;">29/07/12 15:04:38 NORM T1 123 ⇄</td> </tr> </table>	Max. Demand	Power Import	P 11.25 MW	29/07/12 14:30:00	Q 3.590 Mvar	29/07/12 14:57:00	S 11.64 MVA	29/07/12 14:30:00	29/07/12 15:04:38 NORM T1 123 ⇄		Import kW maximum demand Import (inductive) kvar maximum demand Import kVA maximum demand								
Max. Demand	Power Import																		
P 11.25 MW	29/07/12 14:30:00																		
Q 3.590 Mvar	29/07/12 14:57:00																		
S 11.64 MVA	29/07/12 14:30:00																		
29/07/12 15:04:38 NORM T1 123 ⇄																			
<table border="1" style="width: 100%; border-collapse: collapse;"> <tr> <td style="background-color: black; color: white; padding: 2px;">Max. Demand</td> <td style="background-color: black; color: white; padding: 2px;">Power Export</td> </tr> <tr> <td style="padding: 2px;">P 0 MW</td> <td style="padding: 2px;">19/07/12 14:40:00</td> </tr> <tr> <td style="padding: 2px;">Q 0.075 Mvar</td> <td style="padding: 2px;">19/07/12 14:40:00</td> </tr> <tr> <td style="padding: 2px;">S 11.64 MVA</td> <td style="padding: 2px;">29/07/12 14:30:00</td> </tr> <tr> <td colspan="2" style="font-size: small; padding: 2px;">29/07/12 15:04:56 NORM T1 123 ⇄</td> </tr> </table>	Max. Demand	Power Export	P 0 MW	19/07/12 14:40:00	Q 0.075 Mvar	19/07/12 14:40:00	S 11.64 MVA	29/07/12 14:30:00	29/07/12 15:04:56 NORM T1 123 ⇄		Export kW maximum demand Export (inductive) kvar maximum demand Export kVA maximum demand								
Max. Demand	Power Export																		
P 0 MW	19/07/12 14:40:00																		
Q 0.075 Mvar	19/07/12 14:40:00																		
S 11.64 MVA	29/07/12 14:30:00																		
29/07/12 15:04:56 NORM T1 123 ⇄																			
<table border="1" style="width: 100%; border-collapse: collapse;"> <tr> <td style="background-color: black; color: white; padding: 2px;">Max. Demand</td> <td style="background-color: black; color: white; padding: 2px;">kVolts</td> <td style="background-color: black; color: white; padding: 2px;">Voltage</td> </tr> <tr> <td style="padding: 2px;">V1 13.87</td> <td style="padding: 2px;"></td> <td style="padding: 2px;">29/07/12 14:59:00</td> </tr> <tr> <td style="padding: 2px;">V2 13.85</td> <td style="padding: 2px;"></td> <td style="padding: 2px;">29/07/12 14:59:00</td> </tr> <tr> <td style="padding: 2px;">V3 13.89</td> <td style="padding: 2px;"></td> <td style="padding: 2px;">29/07/12 15:01:00</td> </tr> <tr> <td colspan="3" style="font-size: small; padding: 2px;">29/07/12 15:05:24 NORM T1 123 ⇄</td> </tr> </table>	Max. Demand	kVolts	Voltage	V1 13.87		29/07/12 14:59:00	V2 13.85		29/07/12 14:59:00	V3 13.89		29/07/12 15:01:00	29/07/12 15:05:24 NORM T1 123 ⇄			V1-V3 maximum demand Indicate V12-V31 voltage in line-to-line configurations.			
Max. Demand	kVolts	Voltage																	
V1 13.87		29/07/12 14:59:00																	
V2 13.85		29/07/12 14:59:00																	
V3 13.89		29/07/12 15:01:00																	
29/07/12 15:05:24 NORM T1 123 ⇄																			
<table border="1" style="width: 100%; border-collapse: collapse;"> <tr> <td style="background-color: black; color: white; padding: 2px;">Max. Demand</td> <td style="background-color: black; color: white; padding: 2px;">Amps</td> <td style="background-color: black; color: white; padding: 2px;">Current</td> </tr> <tr> <td style="padding: 2px;">I1 282.92</td> <td style="padding: 2px;"></td> <td style="padding: 2px;">29/07/12 14:59:00</td> </tr> <tr> <td style="padding: 2px;">I2 282.98</td> <td style="padding: 2px;"></td> <td style="padding: 2px;">29/07/12 14:59:00</td> </tr> <tr> <td style="padding: 2px;">I3 282.92</td> <td style="padding: 2px;"></td> <td style="padding: 2px;">29/07/12 14:59:00</td> </tr> <tr> <td style="padding: 2px;">In 45.82</td> <td style="padding: 2px;"></td> <td style="padding: 2px;">29/07/12 13:45:00</td> </tr> <tr> <td colspan="3" style="font-size: small; padding: 2px;">29/07/12 15:05:11 NORM T1 123 ⇄</td> </tr> </table>	Max. Demand	Amps	Current	I1 282.92		29/07/12 14:59:00	I2 282.98		29/07/12 14:59:00	I3 282.92		29/07/12 14:59:00	In 45.82		29/07/12 13:45:00	29/07/12 15:05:11 NORM T1 123 ⇄			I1-I3 and In maximum demand
Max. Demand	Amps	Current																	
I1 282.92		29/07/12 14:59:00																	
I2 282.98		29/07/12 14:59:00																	
I3 282.92		29/07/12 14:59:00																	
In 45.82		29/07/12 13:45:00																	
29/07/12 15:05:11 NORM T1 123 ⇄																			

Measurements Data Display

Measurements data represent general instrumentation data you can use while installation and inspecting the meter. Use phase angles displays to check the order of phases when connecting wires to the meter terminals. Use the UP/DOWN button to scroll to the desired data display

<table border="1"> <thead> <tr> <th>Voltage</th> <th>kVolts</th> <th colspan="2">L-N</th> </tr> <tr> <th></th> <th></th> <th>min</th> <th>max</th> </tr> </thead> <tbody> <tr> <td>V1</td> <td>13.87</td> <td>13.86</td> <td>13.87</td> </tr> <tr> <td>V2</td> <td>13.85</td> <td>13.84</td> <td>13.86</td> </tr> <tr> <td>V3</td> <td>13.88</td> <td>13.87</td> <td>13.89</td> </tr> <tr> <td colspan="4">29/07/12 14:56:32 NORM TI 123 ⇄</td> </tr> </tbody> </table>	Voltage	kVolts	L-N				min	max	V1	13.87	13.86	13.87	V2	13.85	13.84	13.86	V3	13.88	13.87	13.89	29/07/12 14:56:32 NORM TI 123 ⇄				<p>Phase-to-neutral voltages. Only displayed in 4-wire configurations with a neutral.</p>
Voltage	kVolts	L-N																							
		min	max																						
V1	13.87	13.86	13.87																						
V2	13.85	13.84	13.86																						
V3	13.88	13.87	13.89																						
29/07/12 14:56:32 NORM TI 123 ⇄																									
<table border="1"> <thead> <tr> <th>Voltage</th> <th>kVolts</th> <th colspan="2">L-L</th> </tr> <tr> <th></th> <th></th> <th>min</th> <th>max</th> </tr> </thead> <tbody> <tr> <td>V12</td> <td>23.98</td> <td>23.97</td> <td>24.00</td> </tr> <tr> <td>V23</td> <td>24.00</td> <td>23.99</td> <td>24.01</td> </tr> <tr> <td>V31</td> <td>24.03</td> <td>24.01</td> <td>24.03</td> </tr> <tr> <td colspan="4">29/07/12 14:56:14 NORM TI 123 ⇄</td> </tr> </tbody> </table>	Voltage	kVolts	L-L				min	max	V12	23.98	23.97	24.00	V23	24.00	23.99	24.01	V31	24.03	24.01	24.03	29/07/12 14:56:14 NORM TI 123 ⇄				<p>Phase-to-phase voltages</p>
Voltage	kVolts	L-L																							
		min	max																						
V12	23.98	23.97	24.00																						
V23	24.00	23.99	24.01																						
V31	24.03	24.01	24.03																						
29/07/12 14:56:14 NORM TI 123 ⇄																									
<table border="1"> <thead> <tr> <th>Voltage</th> <th>kVolts</th> <th colspan="2">Max. Demand</th> </tr> </thead> <tbody> <tr> <td>V1</td> <td>13.87</td> <td colspan="2">29/07/12 14:59:00</td> </tr> <tr> <td>V2</td> <td>13.85</td> <td colspan="2">29/07/12 14:59:00</td> </tr> <tr> <td>V3</td> <td>13.88</td> <td colspan="2">29/07/12 14:59:00</td> </tr> <tr> <td colspan="4">29/07/12 14:59:38 NORM TI 123 ⇄</td> </tr> </tbody> </table>	Voltage	kVolts	Max. Demand		V1	13.87	29/07/12 14:59:00		V2	13.85	29/07/12 14:59:00		V3	13.88	29/07/12 14:59:00		29/07/12 14:59:38 NORM TI 123 ⇄				<p>Phase-to-neutral voltages maximum demand with time stamp</p>				
Voltage	kVolts	Max. Demand																							
V1	13.87	29/07/12 14:59:00																							
V2	13.85	29/07/12 14:59:00																							
V3	13.88	29/07/12 14:59:00																							
29/07/12 14:59:38 NORM TI 123 ⇄																									
<table border="1"> <thead> <tr> <th>Voltage</th> <th colspan="3">Angles</th> </tr> </thead> <tbody> <tr> <td>V1</td> <td>0°</td> <td>I1</td> <td>-17.9°</td> </tr> <tr> <td>V2</td> <td>-120°</td> <td>I2</td> <td>-138°</td> </tr> <tr> <td>V3</td> <td>120°</td> <td>I3</td> <td>102°</td> </tr> <tr> <td colspan="4">29/07/12 14:58:10 NORM TI 123 ⇄</td> </tr> </tbody> </table>	Voltage	Angles			V1	0°	I1	-17.9°	V2	-120°	I2	-138°	V3	120°	I3	102°	29/07/12 14:58:10 NORM TI 123 ⇄				<p>Phase voltage/current angle</p>				
Voltage	Angles																								
V1	0°	I1	-17.9°																						
V2	-120°	I2	-138°																						
V3	120°	I3	102°																						
29/07/12 14:58:10 NORM TI 123 ⇄																									
<table border="1"> <thead> <tr> <th>Voltage</th> <th colspan="2">Frequency</th> </tr> <tr> <th></th> <th>min</th> <th>max</th> </tr> </thead> <tbody> <tr> <td>Hz</td> <td>50.00</td> <td>50.00</td> </tr> <tr> <td colspan="3">29/07/12 14:57:53 NORM TI 123 ⇄</td> </tr> </tbody> </table>	Voltage	Frequency			min	max	Hz	50.00	50.00	29/07/12 14:57:53 NORM TI 123 ⇄			<p>Line frequency</p>												
Voltage	Frequency																								
	min	max																							
Hz	50.00	50.00																							
29/07/12 14:57:53 NORM TI 123 ⇄																									

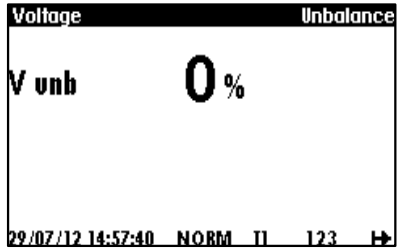
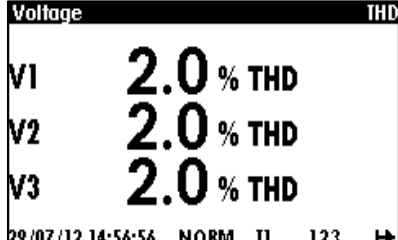
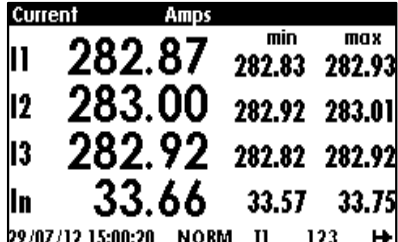
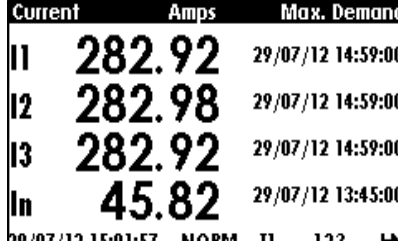
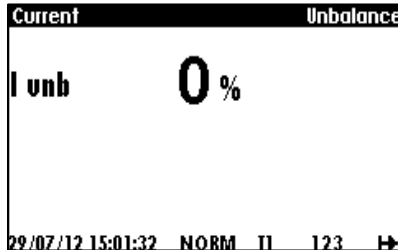
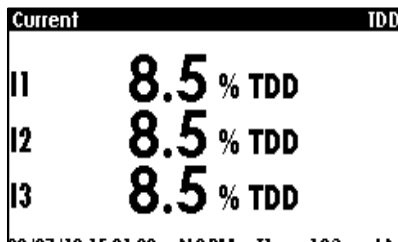
 <p>Voltage Unbalance V unb 0% 29/07/12 14:57:40 NORM TI 123</p>	<p>Voltage unbalance, %</p>
 <p>Voltage THD V1 2.0% THD V2 2.0% THD V3 2.0% THD 29/07/12 14:56:56 NORM TI 123</p>	<p>Phase voltage THD Indicate phase-to-phase voltage THD in line-to-line configurations</p>
 <p>Current Amps I1 282.87 min 282.83 max 282.93 I2 283.00 282.92 283.01 I3 282.92 282.82 282.92 In 33.66 33.57 33.75 29/07/12 15:00:20 NORM TI 123</p>	<p>Phase and neutral currents</p>
 <p>Current Amps Max. Demand I1 282.92 29/07/12 14:59:00 I2 282.98 29/07/12 14:59:00 I3 282.92 29/07/12 14:59:00 In 45.82 29/07/12 13:45:00 29/07/12 15:01:57 NORM TI 123</p>	<p>Phase and neutral currents maximum demand with time stamp</p>
 <p>Current Unbalance I unb 0% 29/07/12 15:01:32 NORM TI 123</p>	<p>Current unbalance, %</p>
 <p>Current TDD I1 8.5% TDD I2 8.5% TDD I3 8.5% TDD 29/07/12 15:01:20 NORM TI 123</p>	<p>Phase Current Total Demand Distorsion, %</p>

<table border="1"> <thead> <tr> <th colspan="2">Current</th> <th colspan="2">THD</th> </tr> </thead> <tbody> <tr> <td>I1</td> <td>15.2</td> <td>% THD</td> <td></td> </tr> <tr> <td>I2</td> <td>15.3</td> <td>% THD</td> <td></td> </tr> <tr> <td>I3</td> <td>15.3</td> <td>% THD</td> <td></td> </tr> <tr> <td colspan="4">29/07/12 15:00:47 NORM TI 123 ↔</td> </tr> </tbody> </table>	Current		THD		I1	15.2	% THD		I2	15.3	% THD		I3	15.3	% THD		29/07/12 15:00:47 NORM TI 123 ↔				<p>Phase Current THD, %</p>								
Current		THD																											
I1	15.2	% THD																											
I2	15.3	% THD																											
I3	15.3	% THD																											
29/07/12 15:00:47 NORM TI 123 ↔																													
<table border="1"> <thead> <tr> <th colspan="2">Power</th> <th colspan="2">Total</th> </tr> <tr> <th></th> <th></th> <th>min</th> <th>max</th> </tr> </thead> <tbody> <tr> <td>P</td> <td>11.07</td> <td>MW</td> <td>11.07 11.08</td> </tr> <tr> <td>Q</td> <td>3.588</td> <td>Mvar</td> <td>3.583 3.592</td> </tr> <tr> <td>S</td> <td>11.64</td> <td>MVA</td> <td>11.63 11.64</td> </tr> <tr> <td>PF</td> <td>0.951</td> <td></td> <td>0.951 0.951</td> </tr> <tr> <td colspan="4">29/07/12 15:02:22 NORM TI 123 ↔</td> </tr> </tbody> </table>	Power		Total				min	max	P	11.07	MW	11.07 11.08	Q	3.588	Mvar	3.583 3.592	S	11.64	MVA	11.63 11.64	PF	0.951		0.951 0.951	29/07/12 15:02:22 NORM TI 123 ↔				<p>Total powers and power factor</p>
Power		Total																											
		min	max																										
P	11.07	MW	11.07 11.08																										
Q	3.588	Mvar	3.583 3.592																										
S	11.64	MVA	11.63 11.64																										
PF	0.951		0.951 0.951																										
29/07/12 15:02:22 NORM TI 123 ↔																													
<table border="1"> <thead> <tr> <th colspan="2">Power</th> <th colspan="2">Max. Demand Export</th> </tr> </thead> <tbody> <tr> <td>P</td> <td>0</td> <td>MW</td> <td>19/07/12 14:40:00</td> </tr> <tr> <td>Q</td> <td>0.075</td> <td>Mvar</td> <td>19/07/12 14:40:00</td> </tr> <tr> <td>S</td> <td>11.64</td> <td>MVA</td> <td>29/07/12 14:30:00</td> </tr> <tr> <td colspan="4">29/07/12 15:04:17 NORM TI 123 ↔</td> </tr> </tbody> </table>	Power		Max. Demand Export		P	0	MW	19/07/12 14:40:00	Q	0.075	Mvar	19/07/12 14:40:00	S	11.64	MVA	29/07/12 14:30:00	29/07/12 15:04:17 NORM TI 123 ↔				<p>Total powers maximum demand export</p>								
Power		Max. Demand Export																											
P	0	MW	19/07/12 14:40:00																										
Q	0.075	Mvar	19/07/12 14:40:00																										
S	11.64	MVA	29/07/12 14:30:00																										
29/07/12 15:04:17 NORM TI 123 ↔																													
<table border="1"> <thead> <tr> <th colspan="2">Power</th> <th colspan="2">Max. Demand Import</th> </tr> </thead> <tbody> <tr> <td>P</td> <td>11.25</td> <td>MW</td> <td>29/07/12 14:30:00</td> </tr> <tr> <td>Q</td> <td>3.590</td> <td>Mvar</td> <td>29/07/12 14:57:00</td> </tr> <tr> <td>S</td> <td>11.64</td> <td>MVA</td> <td>29/07/12 14:30:00</td> </tr> <tr> <td colspan="4">29/07/12 15:03:55 NORM TI 123 ↔</td> </tr> </tbody> </table>	Power		Max. Demand Import		P	11.25	MW	29/07/12 14:30:00	Q	3.590	Mvar	29/07/12 14:57:00	S	11.64	MVA	29/07/12 14:30:00	29/07/12 15:03:55 NORM TI 123 ↔				<p>Total powers maximum demand import</p>								
Power		Max. Demand Import																											
P	11.25	MW	29/07/12 14:30:00																										
Q	3.590	Mvar	29/07/12 14:57:00																										
S	11.64	MVA	29/07/12 14:30:00																										
29/07/12 15:03:55 NORM TI 123 ↔																													
<table border="1"> <thead> <tr> <th colspan="2">Power</th> <th colspan="2">Fundamental Phase L1</th> </tr> </thead> <tbody> <tr> <td>P L1</td> <td>3.688</td> <td>MW</td> <td></td> </tr> <tr> <td>Q L1</td> <td>1.195</td> <td>Mvar</td> <td></td> </tr> <tr> <td>S L1</td> <td>3.877</td> <td>MVA</td> <td></td> </tr> <tr> <td>PF L1</td> <td>0.951</td> <td></td> <td></td> </tr> <tr> <td colspan="4">29/07/12 15:03:29 NORM TI 123 ↔</td> </tr> </tbody> </table>	Power		Fundamental Phase L1		P L1	3.688	MW		Q L1	1.195	Mvar		S L1	3.877	MVA		PF L1	0.951			29/07/12 15:03:29 NORM TI 123 ↔				<p>Phase 1 powers and power factor</p>				
Power		Fundamental Phase L1																											
P L1	3.688	MW																											
Q L1	1.195	Mvar																											
S L1	3.877	MVA																											
PF L1	0.951																												
29/07/12 15:03:29 NORM TI 123 ↔																													
<table border="1"> <thead> <tr> <th colspan="2">Power</th> <th colspan="2">Fundamental Phase L2</th> </tr> </thead> <tbody> <tr> <td>P L2</td> <td>3.683</td> <td>MW</td> <td></td> </tr> <tr> <td>Q L2</td> <td>1.197</td> <td>Mvar</td> <td></td> </tr> <tr> <td>S L2</td> <td>3.872</td> <td>MVA</td> <td></td> </tr> <tr> <td>PF L2</td> <td>0.951</td> <td></td> <td></td> </tr> <tr> <td colspan="4">29/07/12 15:03:41 NORM TI 123 ↔</td> </tr> </tbody> </table>	Power		Fundamental Phase L2		P L2	3.683	MW		Q L2	1.197	Mvar		S L2	3.872	MVA		PF L2	0.951			29/07/12 15:03:41 NORM TI 123 ↔				<p>Phase 2 powers and power factor</p>				
Power		Fundamental Phase L2																											
P L2	3.683	MW																											
Q L2	1.197	Mvar																											
S L2	3.872	MVA																											
PF L2	0.951																												
29/07/12 15:03:41 NORM TI 123 ↔																													

<table border="1"> <thead> <tr> <th colspan="2">Power</th> <th colspan="2">Fundamental Phase L3</th> </tr> </thead> <tbody> <tr> <td>P L3</td> <td>3.693</td> <td>MW</td> <td></td> </tr> <tr> <td>Q L3</td> <td>1.199</td> <td>Mvar</td> <td></td> </tr> <tr> <td>S L3</td> <td>3.882</td> <td>MVA</td> <td></td> </tr> <tr> <td>PF L3</td> <td>0.951</td> <td></td> <td></td> </tr> <tr> <td colspan="4">29/07/12 15:03:47 NORM II 123</td> </tr> </tbody> </table>	Power		Fundamental Phase L3		P L3	3.693	MW		Q L3	1.199	Mvar		S L3	3.882	MVA		PF L3	0.951			29/07/12 15:03:47 NORM II 123				<p>Phase 3 powers and power factor</p>
Power		Fundamental Phase L3																							
P L3	3.693	MW																							
Q L3	1.199	Mvar																							
S L3	3.882	MVA																							
PF L3	0.951																								
29/07/12 15:03:47 NORM II 123																									

Measurements Minimum/Maximum Data Display

Minimum/Maximum displays show measurements minimum/maximum for powers, voltages, currents, power factor and frequency. Each quantity is displayed with the date and time of the last update. Use the UP/DOWN button to scroll to the desired Min/Max data display

<table border="1"> <thead> <tr> <th>Min/Max</th> <th colspan="2">Amps</th> <th>Current</th> </tr> <tr> <td></td> <th>min</th> <th></th> <th>max</th> </tr> </thead> <tbody> <tr> <td>I1</td> <td>282.83</td> <td></td> <td>282.93</td> </tr> <tr> <td></td> <td>29/07/12 15:00:13</td> <td></td> <td>29/07/12 15:00:13</td> </tr> <tr> <td>I2</td> <td>282.92</td> <td></td> <td>283.01</td> </tr> <tr> <td></td> <td>29/07/12 15:00:13</td> <td></td> <td>29/07/12 15:00:13</td> </tr> <tr> <td>I3</td> <td>282.82</td> <td></td> <td>282.92</td> </tr> <tr> <td></td> <td>29/07/12 15:00:14</td> <td></td> <td>29/07/12 15:00:13</td> </tr> <tr> <td colspan="4">29/07/12 15:06:12 NORM II 123</td> </tr> </tbody> </table>	Min/Max	Amps		Current		min		max	I1	282.83		282.93		29/07/12 15:00:13		29/07/12 15:00:13	I2	282.92		283.01		29/07/12 15:00:13		29/07/12 15:00:13	I3	282.82		282.92		29/07/12 15:00:14		29/07/12 15:00:13	29/07/12 15:06:12 NORM II 123				<p>Phase currents minimum/maximum values with time stamp.</p>
Min/Max	Amps		Current																																		
	min		max																																		
I1	282.83		282.93																																		
	29/07/12 15:00:13		29/07/12 15:00:13																																		
I2	282.92		283.01																																		
	29/07/12 15:00:13		29/07/12 15:00:13																																		
I3	282.82		282.92																																		
	29/07/12 15:00:14		29/07/12 15:00:13																																		
29/07/12 15:06:12 NORM II 123																																					
<table border="1"> <thead> <tr> <th>Min/Max</th> <th colspan="2">Amps</th> <th>Neutral Current</th> </tr> <tr> <td></td> <th>min</th> <th></th> <th>max</th> </tr> </thead> <tbody> <tr> <td>In</td> <td>33.47</td> <td></td> <td>33.75</td> </tr> <tr> <td></td> <td>29/07/12 15:01:52</td> <td></td> <td>29/07/12 15:00:13</td> </tr> <tr> <td colspan="4">29/07/12 15:06:24 NORM II 123</td> </tr> </tbody> </table>	Min/Max	Amps		Neutral Current		min		max	In	33.47		33.75		29/07/12 15:01:52		29/07/12 15:00:13	29/07/12 15:06:24 NORM II 123				<p>Neutral current minimum/maximum values with time stamp.</p>																
Min/Max	Amps		Neutral Current																																		
	min		max																																		
In	33.47		33.75																																		
	29/07/12 15:01:52		29/07/12 15:00:13																																		
29/07/12 15:06:24 NORM II 123																																					
<table border="1"> <thead> <tr> <th>Min/Max</th> <th colspan="2">kVolts</th> <th>Voltage L-N</th> </tr> <tr> <td></td> <th>min</th> <th></th> <th>max</th> </tr> </thead> <tbody> <tr> <td>V1</td> <td>13.86</td> <td></td> <td>13.87</td> </tr> <tr> <td></td> <td>29/07/12 15:00:13</td> <td></td> <td>29/07/12 15:00:24</td> </tr> <tr> <td>V2</td> <td>13.83</td> <td></td> <td>13.86</td> </tr> <tr> <td></td> <td>29/07/12 15:01:51</td> <td></td> <td>29/07/12 15:03:15</td> </tr> <tr> <td>V3</td> <td>13.87</td> <td></td> <td>13.90</td> </tr> <tr> <td></td> <td>29/07/12 15:03:20</td> <td></td> <td>29/07/12 15:00:14</td> </tr> <tr> <td colspan="4">29/07/12 15:06:04 NORM II 123</td> </tr> </tbody> </table>	Min/Max	kVolts		Voltage L-N		min		max	V1	13.86		13.87		29/07/12 15:00:13		29/07/12 15:00:24	V2	13.83		13.86		29/07/12 15:01:51		29/07/12 15:03:15	V3	13.87		13.90		29/07/12 15:03:20		29/07/12 15:00:14	29/07/12 15:06:04 NORM II 123				<p>Phase-to-neutral voltages minimum/maximum values with time stamp.</p>
Min/Max	kVolts		Voltage L-N																																		
	min		max																																		
V1	13.86		13.87																																		
	29/07/12 15:00:13		29/07/12 15:00:24																																		
V2	13.83		13.86																																		
	29/07/12 15:01:51		29/07/12 15:03:15																																		
V3	13.87		13.90																																		
	29/07/12 15:03:20		29/07/12 15:00:14																																		
29/07/12 15:06:04 NORM II 123																																					
<table border="1"> <thead> <tr> <th>Min/Max</th> <th colspan="2">kVolts</th> <th>Voltage L-L</th> </tr> <tr> <td></td> <th>min</th> <th></th> <th>max</th> </tr> </thead> <tbody> <tr> <td>V12</td> <td>23.96</td> <td></td> <td>24.01</td> </tr> <tr> <td></td> <td>29/07/12 15:01:51</td> <td></td> <td>29/07/12 15:03:23</td> </tr> <tr> <td>V23</td> <td>23.98</td> <td></td> <td>24.01</td> </tr> <tr> <td></td> <td>29/07/12 15:01:57</td> <td></td> <td>29/07/12 15:00:45</td> </tr> <tr> <td>V31</td> <td>24.01</td> <td></td> <td>24.05</td> </tr> <tr> <td></td> <td>29/07/12 15:05:20</td> <td></td> <td>29/07/12 15:00:24</td> </tr> <tr> <td colspan="4">29/07/12 15:05:37 NORM II 123</td> </tr> </tbody> </table>	Min/Max	kVolts		Voltage L-L		min		max	V12	23.96		24.01		29/07/12 15:01:51		29/07/12 15:03:23	V23	23.98		24.01		29/07/12 15:01:57		29/07/12 15:00:45	V31	24.01		24.05		29/07/12 15:05:20		29/07/12 15:00:24	29/07/12 15:05:37 NORM II 123				<p>Phase-to-phase voltages minimum/maximum values with time stamp.</p>
Min/Max	kVolts		Voltage L-L																																		
	min		max																																		
V12	23.96		24.01																																		
	29/07/12 15:01:51		29/07/12 15:03:23																																		
V23	23.98		24.01																																		
	29/07/12 15:01:57		29/07/12 15:00:45																																		
V31	24.01		24.05																																		
	29/07/12 15:05:20		29/07/12 15:00:24																																		
29/07/12 15:05:37 NORM II 123																																					

<p>Min/Max Power</p> <table border="1"> <thead> <tr> <th></th> <th>min</th> <th>max</th> <th>Unit</th> </tr> </thead> <tbody> <tr> <td>P</td> <td>11.06</td> <td>11.08</td> <td>MW</td> </tr> <tr> <td>Q</td> <td>3.582</td> <td>3.595</td> <td>Mvar</td> </tr> <tr> <td>S</td> <td>11.63</td> <td>11.64</td> <td>MVA</td> </tr> </tbody> </table> <p>29/07/12 15:05:11 29/07/12 15:00:45 29/07/12 15:04:58 29/07/12 15:03:27 29/07/12 15:05:21 29/07/12 15:04:09 29/07/12 15:06:33 NORM II 123</p>		min	max	Unit	P	11.06	11.08	MW	Q	3.582	3.595	Mvar	S	11.63	11.64	MVA	<p>Total powers minimum/maximum values with time stamp.</p>
	min	max	Unit														
P	11.06	11.08	MW														
Q	3.582	3.595	Mvar														
S	11.63	11.64	MVA														
<p>Min/Max PF</p> <table border="1"> <thead> <tr> <th></th> <th>min</th> <th>max</th> </tr> </thead> <tbody> <tr> <td>PF</td> <td>0.951</td> <td>0.951</td> </tr> </tbody> </table> <p>29/07/12 15:00:13 29/07/12 15:00:13 29/07/12 15:06:43 NORM II 123</p>		min	max	PF	0.951	0.951	<p>Total power factor minimum/maximum value with time stamp.</p>										
	min	max															
PF	0.951	0.951															
<p>Min/Max Frequency</p> <table border="1"> <thead> <tr> <th></th> <th>min</th> <th>max</th> </tr> </thead> <tbody> <tr> <td>Hz</td> <td>50.00</td> <td>50.00</td> </tr> </tbody> </table> <p>29/07/12 15:00:13 29/07/12 15:00:13 29/07/12 15:06:53 NORM II 123</p>		min	max	Hz	50.00	50.00	<p>Line frequency minimum/maximum value with time stamp.</p>										
	min	max															
Hz	50.00	50.00															

Measurements Energy Data Display

Energy displays show measurements total import/export for energy and phases energy. Use the UP/DOWN button to scroll to the desired energy data display

<p>Energy Total Import</p> <p>33828 kWh 941 kvarh 33975 kVAh</p> <p>29/07/12 15:07:14 NORM II 123</p>	<p>Total import energy.</p>
<p>Energy Total Export</p> <p>1 kWh 207 kvarh</p> <p>29/07/12 15:07:35 NORM II 123</p>	<p>Total export energy.</p>

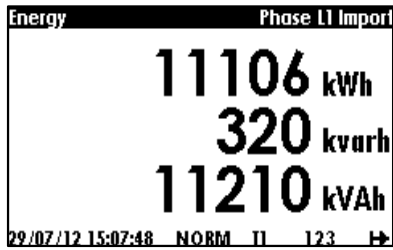
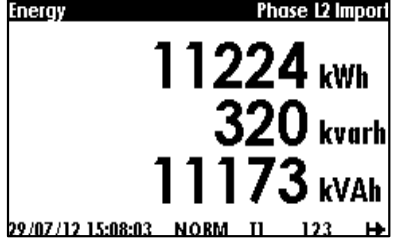
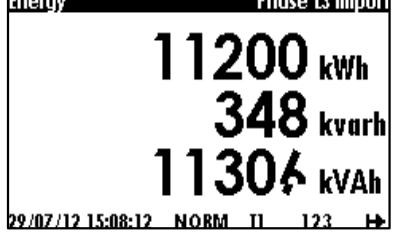
 <p>Energy Phase 1 Import</p> <p>11106 kWh 320 kvarh 11210 kVAh</p> <p>29/07/12 15:07:48 NORM II 123</p>	<p>Phase 1 import energy.</p>
 <p>Energy Phase 2 Import</p> <p>11224 kWh 320 kvarh 11173 kVAh</p> <p>29/07/12 15:08:03 NORM II 123</p>	<p>Phase 2 import energy.</p>
 <p>Energy Phase 3 Import</p> <p>11200 kWh 348 kvarh 11304 kVAh</p> <p>29/07/12 15:08:12 NORM II 123</p>	<p>Phase 3 import energy.</p>

Harmonics Display

Harmonics display shows individual harmonics distortion for phase voltages and current, and phase voltage/current harmonic spectrum graphs. Use the UP/DOWN button to scroll to the specific harmonic number or voltage and current channels harmonic spectrum.

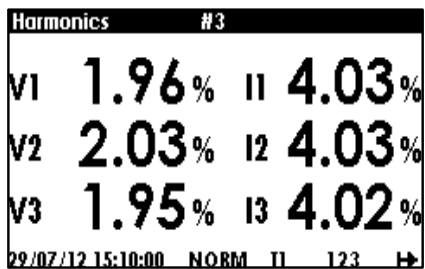
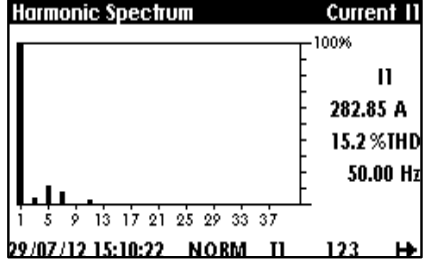
 <p>Harmonics #3</p> <p>V1 1.96% I1 4.03% V2 2.03% I2 4.03% V3 1.95% I3 4.02%</p> <p>29/07/12 15:10:00 NORM II 123</p>	<p>Individual harmonics phase voltages and currents, %</p>
 <p>Harmonic Spectrum Current I1</p> <p>100% I1 282.85 A 15.2%THD 50.00 Hz</p> <p>1 5 9 13 17 21 25 29 33 37</p> <p>29/07/12 15:10:22 NORM II 123</p>	<p>Per-phase current harmonic spectrum I1-I3</p>

Waveform Display

The waveform display shows per-phase voltage and current waveforms and V/I values + THD. Use the UP/DOWN button to scroll through the phases.

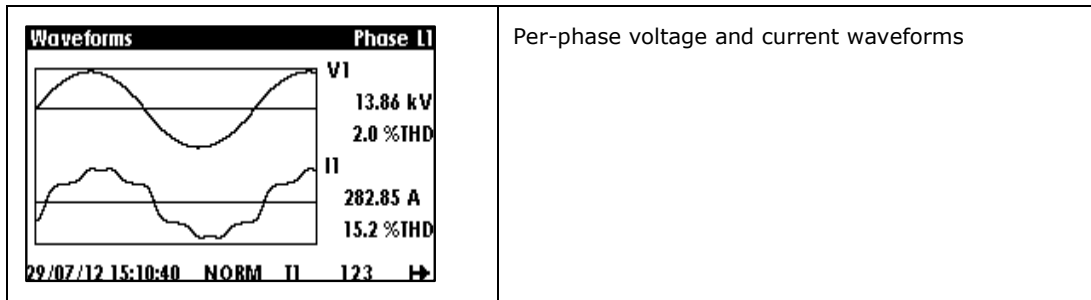

Phasor Display

The Phasor display shows a three-phase network Phasor diagram. All phase angles are given relatively to the V1 channel.

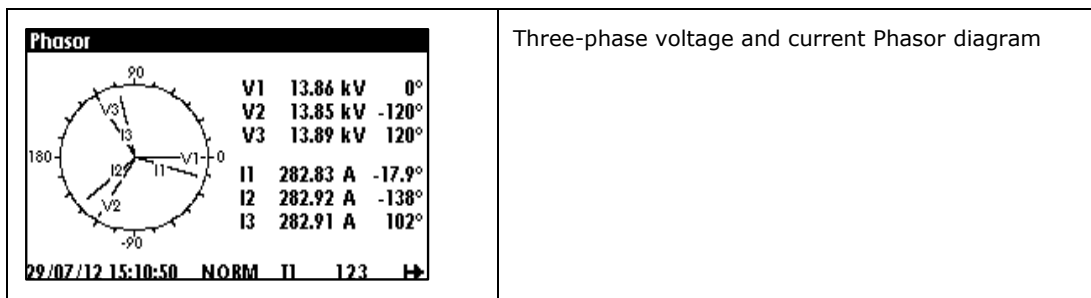

Digital I/O

The Digital I/O display shows three sub-menus: "Digital Inputs" display to show status of each digital input, "Pulse/Event Counters" display to count external pulses or setpoint events, or as time counters to count setpoint operation time, "Relay Outputs" display to show status of each relay output. Use the UP/DOWN button to move from one display to another.

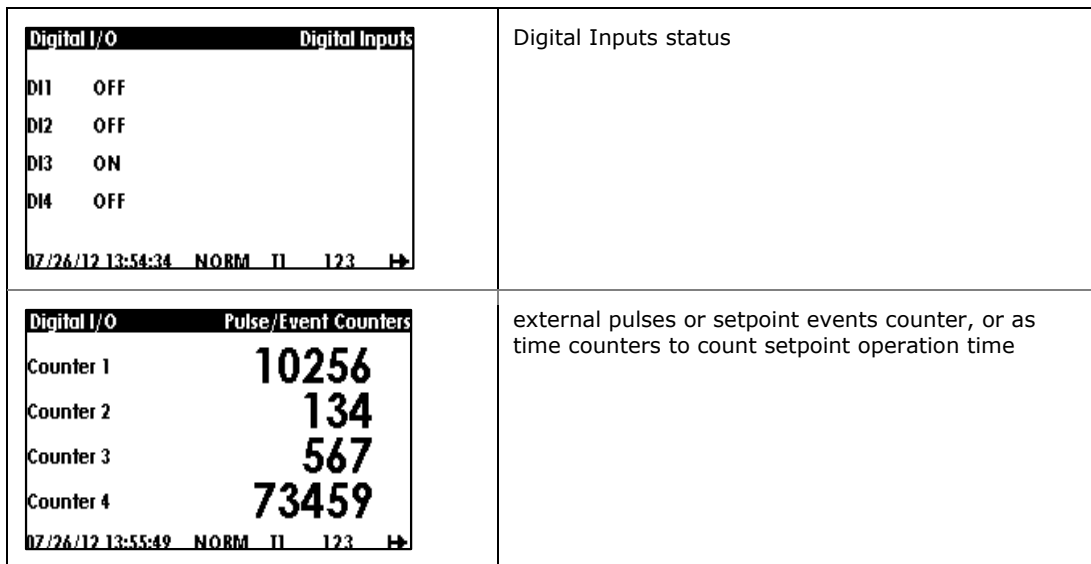

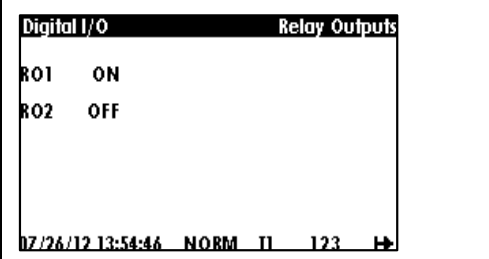
	Relay outputs status
---	----------------------

Device Control Display

The device control display shows two sub-menus: "Diagnostics" and "Alarms". The diagnostics display shows device diagnostic messages recorded as a result of the meter self-test diagnostics during start-up and operation, the alarm display shows a list of operated alarm setpoints along with the alarm trigger labels if there are alarms recorded during meter operation.

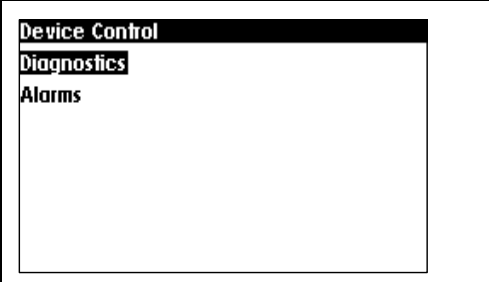
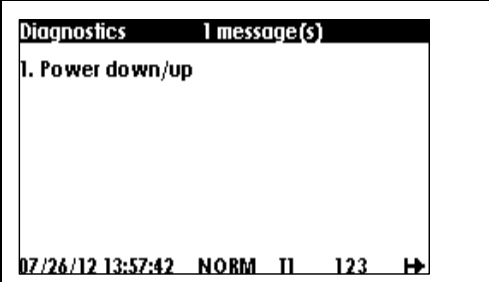
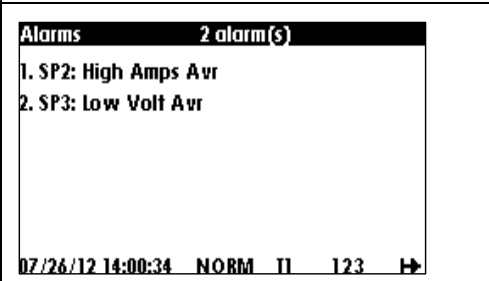
	Device Control sub-menu, use the UP/DOWN button to select whether Diagnostics or Alarms displays
	List of diagnostics messages
	List of alarms messages

If there are diagnostic messages, the  diagnostic green led on the device panel flashes until you clear the device diagnostics. Some of the diagnostics events are cleared automatically as the event source disappears. See [Device Diagnostic Codes](#) in Appendix H for a full list of diagnostic messages and their meanings. See [Clearing Device Diagnostics](#) for information on how to clear the device diagnostics from the display and via PAS.

The diagnostic Led indication can be disabled or enabled via the [Display Setup](#) menu.

Basic Settings Display

The basic settings display shows basic device settings that can be required for immediate inspecting while meter testing and at the time of installation. Use the UP/DOWN button to scroll through the settings

<table border="1"> <thead> <tr> <th>Basic Settings</th> <th>Page 1/2</th> </tr> </thead> <tbody> <tr> <td>Wiring mode</td> <td>4LN3</td> </tr> <tr> <td>PT Ratio</td> <td>1.0</td> </tr> <tr> <td>PT Ratio Multiplier</td> <td>1</td> </tr> <tr> <td>CT Primary Current, A</td> <td>5</td> </tr> <tr> <td>Power Dmd Period, min</td> <td>15</td> </tr> <tr> <td>Blocks in Sliding Demand</td> <td>1</td> </tr> <tr> <td>07/26/12 14:00:56</td> <td>NORM TI 123 ⇄</td> </tr> </tbody> </table>	Basic Settings	Page 1/2	Wiring mode	4LN3	PT Ratio	1.0	PT Ratio Multiplier	1	CT Primary Current, A	5	Power Dmd Period, min	15	Blocks in Sliding Demand	1	07/26/12 14:00:56	NORM TI 123 ⇄	<p>Device wiring mode (see Basic Meter Setup for full list of wiring modes), external potential transformer ratio and the nominal device voltage. Primary ratings of the external current transformers (main and auxiliary current inputs) and the nominal device frequency Power demand period (number of blocks x block demand period), and voltage and ampere demand periods.</p>
Basic Settings	Page 1/2																
Wiring mode	4LN3																
PT Ratio	1.0																
PT Ratio Multiplier	1																
CT Primary Current, A	5																
Power Dmd Period, min	15																
Blocks in Sliding Demand	1																
07/26/12 14:00:56	NORM TI 123 ⇄																
<table border="1"> <thead> <tr> <th>Basic Settings</th> <th>Page 2/2</th> </tr> </thead> <tbody> <tr> <td>Volt/Ampere Dmd Period</td> <td>900</td> </tr> <tr> <td>Nominal Frequency, Hz</td> <td>50</td> </tr> <tr> <td>Max. Dmd Load Current, A</td> <td>CT</td> </tr> <tr> <td>07/26/12 14:01:19</td> <td>NORM TI 123 ⇄</td> </tr> </tbody> </table>	Basic Settings	Page 2/2	Volt/Ampere Dmd Period	900	Nominal Frequency, Hz	50	Max. Dmd Load Current, A	CT	07/26/12 14:01:19	NORM TI 123 ⇄							
Basic Settings	Page 2/2																
Volt/Ampere Dmd Period	900																
Nominal Frequency, Hz	50																
Max. Dmd Load Current, A	CT																
07/26/12 14:01:19	NORM TI 123 ⇄																

Device Info Display

The device info display provides different service information that may be required for meter identification and inspection, like product/module and firmware information, I/O module type, communication settings, and so on. Use the UP/DOWN button to scroll through the device info.

<table border="1"> <thead> <tr> <th>Device Info</th> <th>Features</th> </tr> </thead> <tbody> <tr> <td>Model</td> <td>PMT35EH</td> </tr> <tr> <td>Serial Number</td> <td>952737</td> </tr> <tr> <td>Firmware Ver.</td> <td>V35.1.1</td> </tr> <tr> <td>Bootloader Ver.</td> <td>V1.1.1</td> </tr> <tr> <td>COM Module Ver.</td> <td>V61.1.5</td> </tr> <tr> <td>I/O Module Type</td> <td>N/A</td> </tr> <tr> <td>07/26/12 14:02:11</td> <td>NORM TI 123 ⇄</td> </tr> </tbody> </table>	Device Info	Features	Model	PMT35EH	Serial Number	952737	Firmware Ver.	V35.1.1	Bootloader Ver.	V1.1.1	COM Module Ver.	V61.1.5	I/O Module Type	N/A	07/26/12 14:02:11	NORM TI 123 ⇄	Meter identification info
Device Info	Features																
Model	PMT35EH																
Serial Number	952737																
Firmware Ver.	V35.1.1																
Bootloader Ver.	V1.1.1																
COM Module Ver.	V61.1.5																
I/O Module Type	N/A																
07/26/12 14:02:11	NORM TI 123 ⇄																
<table border="1"> <thead> <tr> <th>Device Info</th> <th>Ports</th> </tr> </thead> <tbody> <tr> <td>COM1</td> <td>1, 115200, Modbus RTU</td> </tr> <tr> <td>COM2</td> <td>Ethernet, 126, Modbus RTU</td> </tr> <tr> <td>MAC</td> <td>0005f00000cc</td> </tr> <tr> <td>IP Address</td> <td>192.168.0.212</td> </tr> <tr> <td>Def. Gateway</td> <td>192.168.0.1</td> </tr> <tr> <td>07/26/12 14:03:38</td> <td>NORM TI 123 ⇄</td> </tr> </tbody> </table>	Device Info	Ports	COM1	1, 115200, Modbus RTU	COM2	Ethernet, 126, Modbus RTU	MAC	0005f00000cc	IP Address	192.168.0.212	Def. Gateway	192.168.0.1	07/26/12 14:03:38	NORM TI 123 ⇄	Meter communication info		
Device Info	Ports																
COM1	1, 115200, Modbus RTU																
COM2	Ethernet, 126, Modbus RTU																
MAC	0005f00000cc																
IP Address	192.168.0.212																
Def. Gateway	192.168.0.1																
07/26/12 14:03:38	NORM TI 123 ⇄																

Load Bar Graph

The load bar graph displays the amount, in percent (40% to 110%), of the present current load with respect to user-defined nominal load current. The reference nominal current can be set up in amps through the display setup (see [Configuring the Display](#)). If it is set to 0 (default), the current load is referenced to the specified CT primary current.

Energy Pulse LED

The PM135E and PM135EH have a red “Energy Pulse” LED. It flashes at a constant rate when a load is applied to the meter.

There are two modes of LED operation:

- **NORMAL mode:** the LED pulses indicate imported Wh at a rate of 1,000 pulses per kWh
- **TEST mode:** the LED pulses indicate either imported Wh, or imported (inductive) varh at a rate of 10,000 pulses per kWh/kvarh

The energy test mode can be enabled through the [Device Options](#) setup. When in test mode, the energy and demand accumulators do not account for consumed energy.

Port Activity LEDs

The meter has two green LEDs “RX” and “TX”, which indicate activity on the COM1 communication port. The LEDs flash when the port is receiving or transmitting data.

3.3 Device Setup

The PM135 setup is menu-driven. The device provides 12 menus that allow local accessing a limited number of meter setups and control functions listed in the following table. Access to particular menus is granted depending on the password you entered if enabled.

Menu Label	Menu Function
Reset	Reset of engineering maximum demands, device diagnostics, meter and battery operation time counters and failure counters
Real Rime Clock	RTC clock setup
Display Setup	Display setup
Basic Setup	Basic device setup
Device options	Device options setup
COM1 Setup	COM1 serial port setup
Local Settings	Local settings
Setpoint Setup	
Password Setup	Meter passwords setup

Entering the Password

The Setup Change menu can be secured by a four-digit user password.

You can change the password and enable password protection through the Access Control menu (see [Configuring Meter Security](#)). The meter is primarily shipped with the password preset to 0 and password protection disabled.

If password protection is enabled, you are prompted for a password when entering the setup change menu.

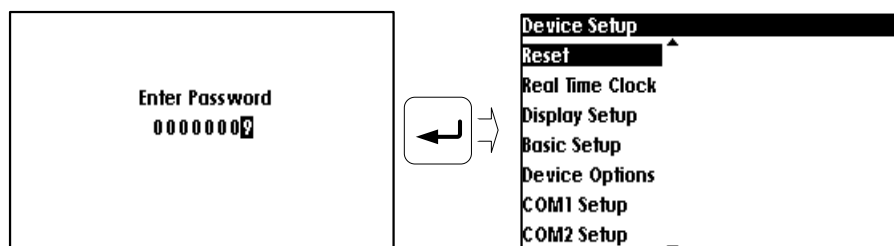

To enter the password:

1. Select the desired digit field using the **TAB** button
2. Select the desired digit using the **UP/DOWN** button
3. Press **ENTER** to confirm the password.

If the password you entered is correct, you are moved to the Main menu, otherwise you return back to the Device Setup menu.

Viewing and Changing Setup Options

Once you entered a correct password you are moved to the Device Setup menu.

The Device Setup menu consists of sub-menus list.

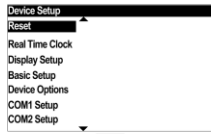

To select a desired menu entry from the menu list:



Use the **UP/DOWN** button -   to scroll through the menu list to the desired menu entry

Press the **SELECT/ENTER** button -  to enter the selected submenu.

Parameters that are represented by values can be changed in two ways:

- By pressing the **SELECT/ENTER** button - , a new sub-menu appears by presenting possible values to be selected
- By pressing the **TAB** button - , the highlight cursor moves to the actual value to be changed

Use the **UP/DOWN** button -   to scroll through the desired value, then press the **SELECT/ENTER** button -  to store the selected value

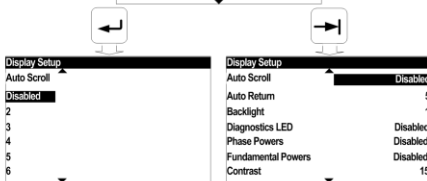

Note: While being in the Device Setup operation mode, the PM135 display will return to normal operation, i.e. move to data display, during idle operation of one minute

Chapter 4 Using PAS Software

The support PAS software is a configuration and data acquisition tool that allows you to configure all of the PM135 features, monitor your meters on-line, retrieve recorded files and view reports. PAS can communicate with your PM135 via a serial port and via the Ethernet.

This chapter gives information on how to install and run PAS on your computer, and how to prepare information for your meter using PAS.

See Chapter 5 [Configuring the PM135](#) for instructions on how to configure particular features in your meter. Refer to Chapters 7 and 8 for instructions on retrieving data from the meters and viewing reports.

4.1 Installing PAS

You need PAS V1.4 Build 4 or higher to take an advantage of the meter data logging options.

To install PAS on your PC:



1. Insert the installation CD supplied with your meter into CD drive.
2. Open **My Computer** on your Desktop.
3. Click on your CD drive icon, select the PAS directory, and then double click on Setup (shown as an Application type file).
4. Follow InstallShield® Wizard instructions on the screen.

PAS is installed by default to the C:\Pas folder.

When installation is complete, the PAS icon appears on your Desktop. Double click on the PAS icon to run PAS.

For general information on how to work with PAS, see the "PAS Getting Started" guide supplied on the installation CD.

4.2 Creating a New Site for your Meter

PAS keeps all communication and configuration data for your meter in a configuration database called a site database. During configuration, store all setup data to the site database so that PAS recognizes device properties regardless of whether the meter is online or offline.

To communicate with the meters, create a separate site database for each device.

To create a new database for your meter:

1. Select **Configuration** from the **Tools** menu.

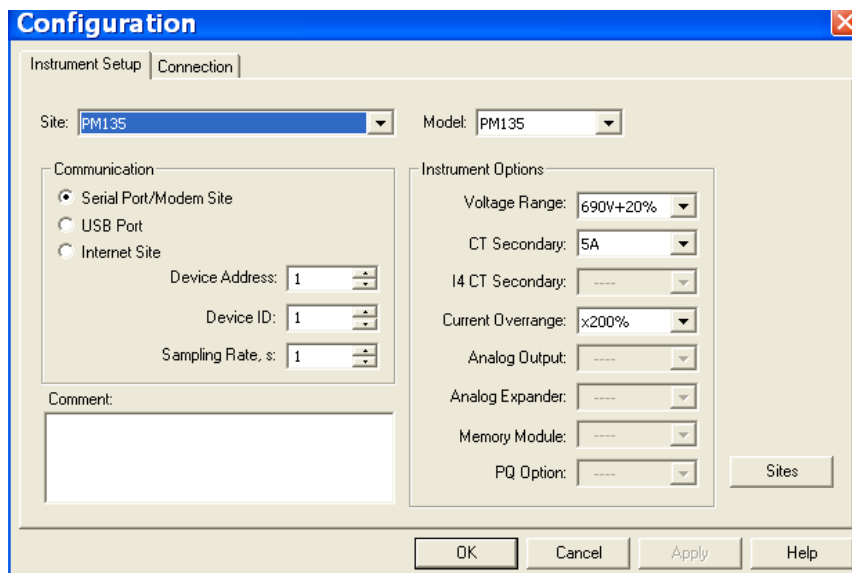
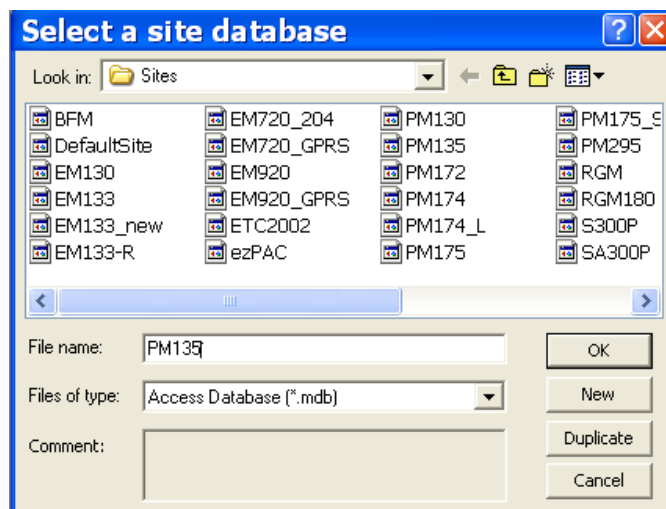

Figure 4-1: Configuration Dialog Box – Instrument Setup Tab

- Click the **Sites** button on the right-hand-side.



- From the **Look in** box, select the directory where a new database will be stored. By default, it is the **Sites** directory.
- Type a site name for your device in the **File name** box, click **New**, and then click **OK**.
- On the **Instrument Setup** tab, select **PM135** in the **Model** box. PAS automatically selects the appropriate instrument options for your meter.
- Select a correct CT secondary current (5A or 1A) for your meter.
- If you wish to add any comments for your meter, type the comments in the **Comment** box.

4.3 Setting up Communications

You can communicate with the PM135 via a PC RS-232 serial port or through the Internet.

To configure communications with the PM135:

1. Select **Configuration** from the **Tools** menu. Under the **Communication** group on the **Instrument Setup** tab, select the type of connection for your device.
2. Set the device communication address you assigned to the PM135 port. When communicating via the Ethernet, the PM135 responds to any address you select.
3. In the **Sampling Rate** box, select a rate at which PAS updates data on your screen when you continuously poll the device in the PAS Data Monitor.

The communication protocol and port settings must match the settings you made in your meter.

Communicating through a Serial Port

Select **Serial Port/Modem Site** on the **Configuration** tab, and then click on the **Connection** tab to configure your serial port settings.

Configuring a Serial Port

1. On the **Connection** tab, select a COM port from the **Device** box, and then click **Configure**.



Figure 4-2: Serial Port Setup Dialog Box

2. Specify the baud rate and data format for the port. Choose the same baud rate and data format as you have set in the meter, and then click OK.

The factory settings for the local PM135 RS-232 and RS-422/485 ports are 9600 baud, 8 bits with no parity.

Selecting the Communications Protocol

1. On the **Connection** tab, click **Protocol**.

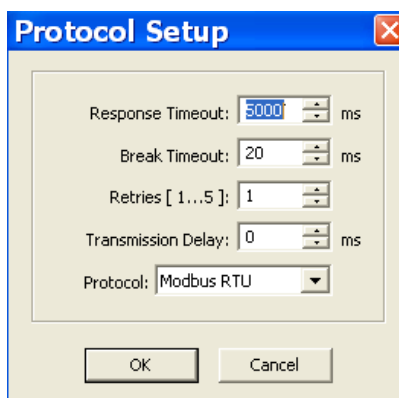

Figure 4-3: Protocol Setup Dialog Box

2. In the **Protocol** box, select the same communications protocol as you have set in your meter.
3. In the **Response Timeout** box, define the maximum time that PAS should wait for the meter response before announcing a failure.
4. In the **Break Timeout** box, define the maximum line idle time that PAS should wait after receiving the last message character before closing a connection with the Modbus RTU or DNP3 protocol. It does not affect ASCII communications. Note that this time is added to the message transfer time, and excessive increasing it may slow down communications. If you frequently receive the "Communication error" message, try to increase **Break Timeout**.
5. In the **Retries** box, define the number of attempts that PAS should use to receive a response from the meter in the event the communication fails, before announcing a communication failure.

Communicating through the Internet

If you are communicating through the Ethernet port, define the IP address of your meter on the network.

To configure the meter IP address:

1. On the Instrument Setup tab, select Internet Site.
2. Click on the **Connection** tab.
3. Click on the **IP address** and type in the IP address of your meter. The default IP address preset in the meter at the factory is 192.168.0.203.
4. In the **Protocol** box, select the communications protocol for the TCP port. The meter provides Modbus/TCP connections on TCP port 502 and DNP3/TCP connections on port 20000. The host port is set automatically as you select the protocol. Select **Modbus RTU/TCP** for Modbus/TCP or **DNP3** for DNP3/TCP.
5. In the **Wait for answer** box, adjust the time that PAS waits for a

connection before announcing an error.

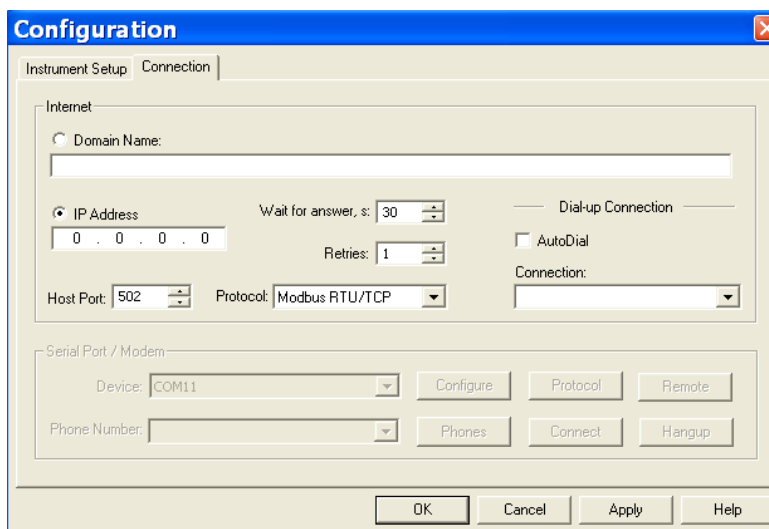

Figure 4-4: Configuration Dialog Box – Connection Tab

6. In the **Retries** box, specify the number of retries PAS will use to receive a response from the meter if communications fail.
7. Click **OK**.

4.4 Setting Up the Meter

Preparing Setups for the Meter

PAS allows you to prepare setup data for your meter off-line without the need to have it connected to your PC.

To prepare a setup for your meter:

1. Select the device site from the list box on the PAS toolbar.
2. Select the desired setup group from the **Meter Setup** menu. Click on the tab with the setup you want to create or modify.
3. Fill in the boxes with the desired configuration data for your meter.
4. Click the **Save as...** button to store the data to the meter site database.
5. Click **OK**.



Always set up and store the Basic Setup data to the site database first. PAS uses this data as a reference when arranging other meter setups.

To save your setup to another site database:

1. Click the **Save as...** button.

2. Select the target database from the file pane.
3. Click **OK**.

You can also reuse a setup from another site by copying it to your present site database.

To copy a setup from another site's database:

1. Click **Open**.
2. Select the desired source site database.
3. Click **OK**. The opened setup is copied to your dialog window.
4. Click the **Save as...** button.
5. Select the target database from the file pane.
6. Click **OK**.

To copy all setups from one site database to another site's database:

1. In the list box on the toolbar, select a source device site from which you wish to copy setups.
2. Select **Copy to...** from the **Meter Setup** menu.
3. Select the target site database to which you wish to copy setups, and click **OK**.

Downloading Setups to the Meter

You can update each setup in your meter one at a time or download all setups together from the site database.

Individual Download

To update a particular setup in your meter:

1. Check the **On-line** button on the PAS toolbar
2. Select a meter site from the list box on the toolbar.
3. Select the desired setup group from the **Meter Setup** menu. Click on the setup tab you want to download to the meter. As the setup dialog box opens, PAS retrieves and displays the present meter setup data.
4. If you wish to download a setup saved in the site database, click **Open**, and then click **OK**, or fill in the boxes with the desired configuration data for your device.
5. Click **Send**.

Batch Download

To download all setups to your device at once:

1. Check the **On-line** button on the PAS toolbar
2. Select the device site from the list box on the toolbar.
3. Select **Download Setups** from the **Meter Setup** menu.

Uploading Setups from the Meter

Individual Upload

To get a particular setup from your device:

1. Check the **On-line** button on the PAS toolbar.
2. Select a meter site from the list box on the toolbar, and then select the desired setup group from the **Meter Setup** menu.
3. Click on the tab of the setup you want to read from the meter. As the dialog box opens, PAS retrieves and displays the present setup data from the meter. Click **Receive** if you wish to retrieve the meter setup once again.
4. To store the setup to the meter site database, click **Save As**, and then click **OK**.

Batch Upload

To upload all setups from the device to the site database at once:

1. Check the **On-line** button on the toolbar.
2. Select the device site from the list box on the toolbar.
3. Select **Upload Setups** from the **Meter Setup** menu.

4.5 Authorization

If communications with your meter is secured, you are prompted for the password when you send new setup data to the meter.

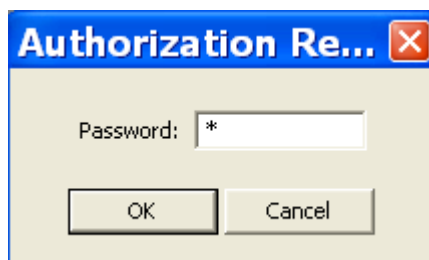

Figure 4-5: Authorization Dialog Box

Enter the password and click **OK**.

If your authorization was successful, you are not prompted for the password again until you close the dialog box.

See [Configuring Meter Security](#) in Chapter 5 for more information on the meter password security.

Chapter 5 Configuring the PM135

This chapter describes how to configure different options in your meter from the front panel display or via PAS.

5.1 Configuring Communications

Setting Up Serial Communication Ports

Using the Front Display

Select **COM1 Setup** or **COM2 Setup** from the Device Setup menu. See [Viewing and Changing Setup Options](#) in Chapter 3 for information on configuring parameters via the front display.

Device Setup
Reset
Real Time Clock
Display Setup
Basic Setup
Device Options
COM1 Setup
COM2 Setup

See below for available communication options.

COM1 Setup	
Protocol	Modbus RTU
Interface	RS485
Device Address	1
Baud Rate	19200
Data Format	8N
Response Delay, ms	5

Using PAS

Select **Communications Setup** from the **Meter Setup** menu, and then click on the **Serial Ports Setup** tab. In the **Port** box, select the desired device port.

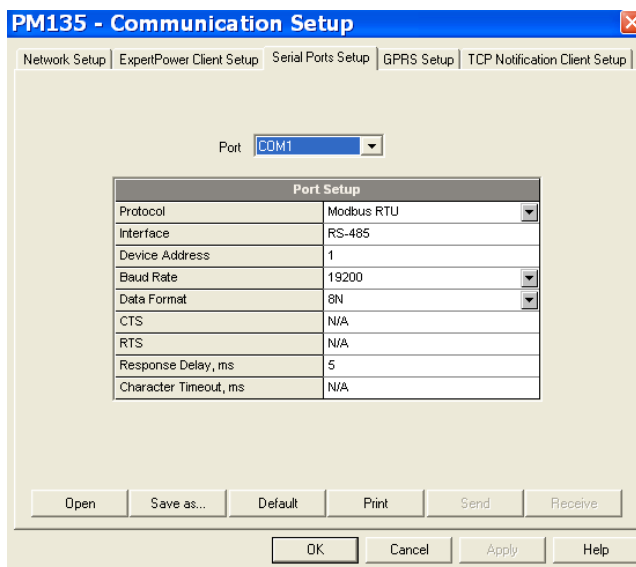

Figure 5-1: Communication Setup Dialog Box – Serial Ports Setup Tab

See Table 3 below for available communication options.

Table 3: COM Port Options

Parameter	Options	Default	Description
Protocol	MODBUS ASCII SATEC ASCII MODBUS RTU DNP3 IEC 60870-5 PROFIBUS DP (COM2)	MODBUS RTU	The communications protocol for the port. Not changeable on COM2 with the PROFIBUS module.
Interface	COM1: 485 = RS-485 COM2: 232 = RS-232 485 = RS-485 422 = RS-422 Eth = Ethernet PRO = PROFIBUS DP GPRS = GPRS modem	RS-485	Communication interface. Not changeable on COM2 with the Ethernet and PROFIBUS modules.
Device address	SATEC ASCII: 0-99 MODBUS: 1-247 DNP3: 0-65532 PROFIBUS: 0-126	1 (126 for PROFIBUS)	Device network address.
Baud rate	300 bps-115.2 kbps	9600 bps	The port baud rate.
Data format	7E, 8N, 8E	8N	Data format and parity. 7E data format should not be used with the MODBUS RTU and DNP3 protocols.
Response delay	0-1000 ms	5 ms	The minimum time after the last request character is received to start the transmission.

NOTES:

1. The meter provides the permanent MODBUS TCP server on port 502.

2. Selecting the DNP3 protocol launches the second DNP3 TCP server in addition to the MODBUS server allowing simultaneous connections on both ports. Selecting the MODBUS protocol disables the DNP3 TCP server.
3. When you change the COM2 settings through the Ethernet port, the device port restarts so communications will be temporarily lost. You may need to wait some additional time until PAS restores a connection with your device.

Setting Up Ethernet

Using the Front Display

Select **Network Setup** from the Device Setup menu. **This menu entry appears only if the optional Ethernet module is plugged into the meter.** It allows you to set up the meter network address and the default gateway.

See [Viewing and Changing Setup Options](#) in Chapter 3 for information on configuring parameters via the front display.

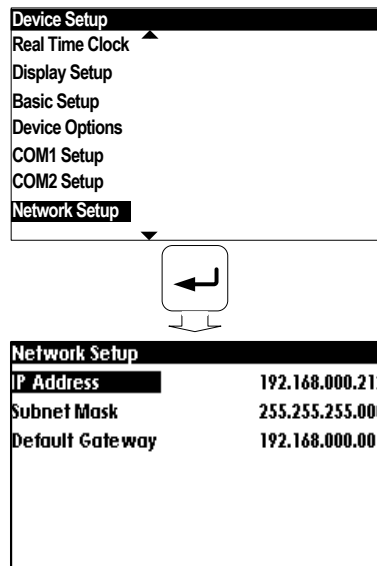

Using PAS

Select **Communications Setup** from the **Meter Setup** menu, and then click on the **Network Setup** tab.

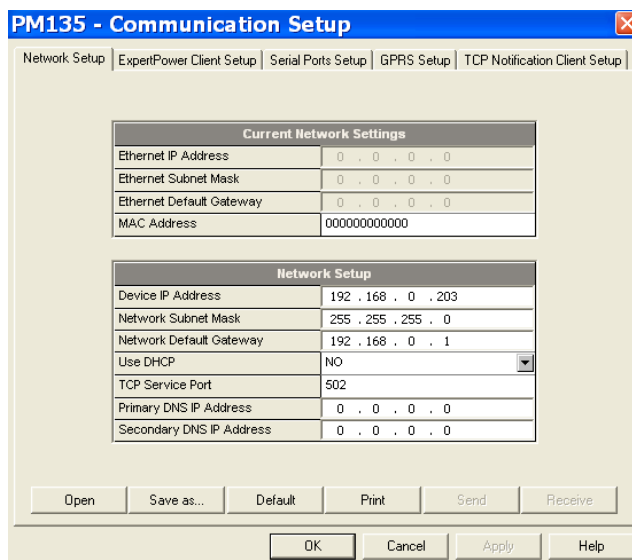

Figure 5-2: Communication Setup Dialog Box – Network Setup Tab

The table below lists available network options.

Table 4: Ethernet Setup Options

Parameter	Options	Default
Device IP Address		192.168.0.203
Network Subnet Mask		255.255.255.0
Network Default Gateway		192.168.0.1
TCP Service Port	502 = Modbus/TCP 20000 = DNP3/TCP	502

NOTES

1. The meter provides the permanent MODBUS TCP server on port 502.
2. Selecting the DNP3 TCP service port launches the second DNP3 TCP server allowing simultaneous connections on both TCP ports. Selecting the MODBUS TCP port disables the DNP3 TCP server.



The TCP service port can also be changed through the COM2 serial port setup. Changing the communication protocol for the port automatically changes the TCP port for the Ethernet.

3. When you change the device network settings through the Ethernet port, the device port restarts so communication will be temporarily lost. You may need to wait some additional time until PAS restores a connection with your device.

Setting Up GPRS Network

The PM135 can provide wireless GPRS communications with the remote MODBUS/TCP server via the GPRS modem module. See [Connecting a](#)

[GSM/GPRS modem](#) in Chapter 2 on how to connect a modem to your meter.

Using the Front Display

Select **GPRS** interface from the COM2 Setup menu. **This menu entry appears only if the optional GPRS module is plugged into the meter.** It allows you to set up the meter network address and the default gateway.

See [Viewing and Changing Setup Options](#) in Chapter 3 for information on configuring parameters via the front display

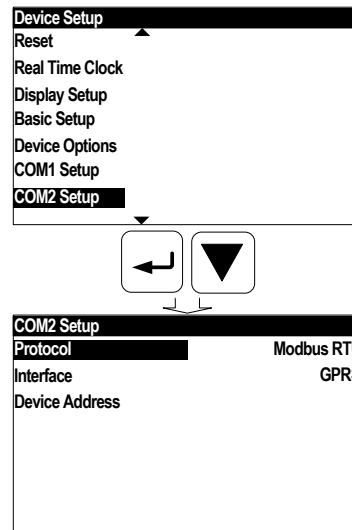

Using PAS

To set up GPRS communications:

1. Select **Communications Setup** from the **Meter Setup** menu, and then click on the **GPRS Setup** tab.

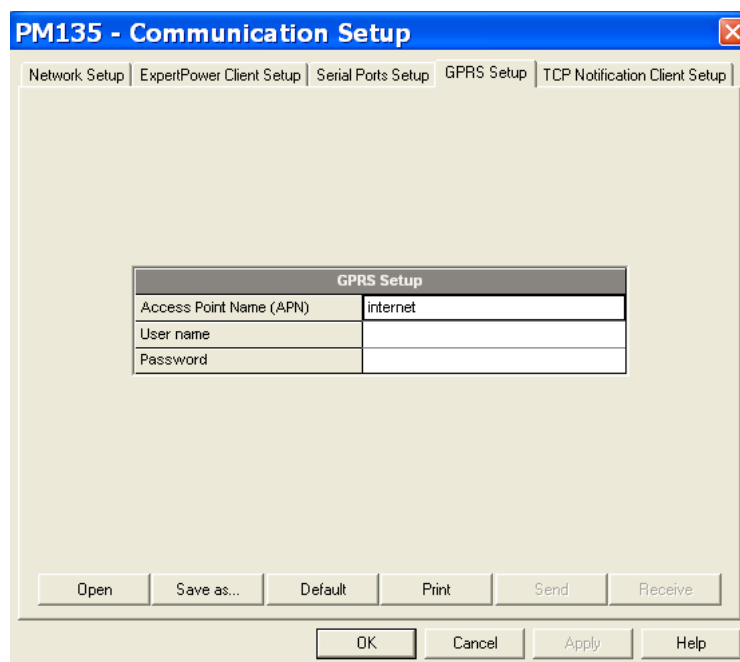

Figure 5-3: Communication Setup Dialog Box – GPRS Setup Tab

The following table lists available GPRS options.

Table 5: GPRS Setup Options

Parameter	Default	Description
Access Point Name (APN)	internetg	The mobile network APN name
User name		Username (if required)
Password		Password (if required)

2. Configure your mobile network APN, username and password. Consult your network operator regarding proper network settings. Leave the username and password fields blank if network authorization is not required.
3. Send your GPRS settings to the meter.
4. Select the GPRS interface in the COM2 port setup (see [Setting Up Serial Communication Ports](#)).
5. Configure your eXpertPower client (see [Setting Up eXpertPower Client](#)) or/and TCP Notification client (see [Setting Up TCP Notification Client](#)) for communicating with a remote server.

You can check the status of the GPRS communications from the front panel via the [Status Display](#) or via the Device Control dialog in PAS (see [Viewing Communication Status and Statistics](#)).

Setting Up eXpertPower Client

The PM135 has an embedded eXpertPower™ client that provides communications with the eXpertPower™ server – the SATEC proprietary Internet services. Connections to the eXpertPower™ server are handled on a periodic basis.

To set up communications with the eXpertPower™ server, select **Communication Setup** from the **Meter Setup** menu, and then click on the **ExpertPower Client Setup** tab.

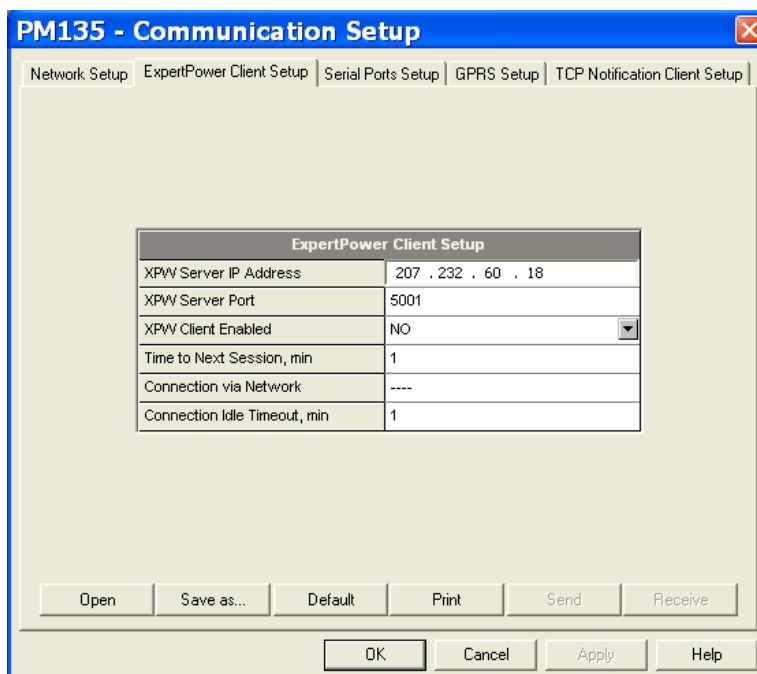

Figure 5-4: eXpertPower Client Setup Tab

The following table lists available options. Refer to your eXpertPower service provider for the correct network settings.

Table 6: eXpertPower Client Setup Options

Parameter	Options	Default	Description
XPW Server IP Address		207.232.60.18	The IP address of the eXpertPower server
XPW Server Port	0-65535	5001	The TCP service port of the eXpertPower server
XPW Client Enabled	NO, YES	NO	Enables operations of the eXpertPower client
Time to Next Session, min	1-99999		The time remaining to the next connection session

NOTES

6. Do not enable the eXpertPower client in your meter if you do not use the eXpertPower™ service.
7. Do not change the connection time setting. It is for information only. The eXpertPower server updates it automatically.

Setting Up TCP Notification Client

The TCP notification client can establish connections with a remote MODBUS/TCP server and send notification messages either on events, or periodically on a time basis.

To set up communications with a remote TCP Notification server, select **Communication Setup** from the **Meter Setup** menu, and then click on the **TCP Notification Client Setup** tab.

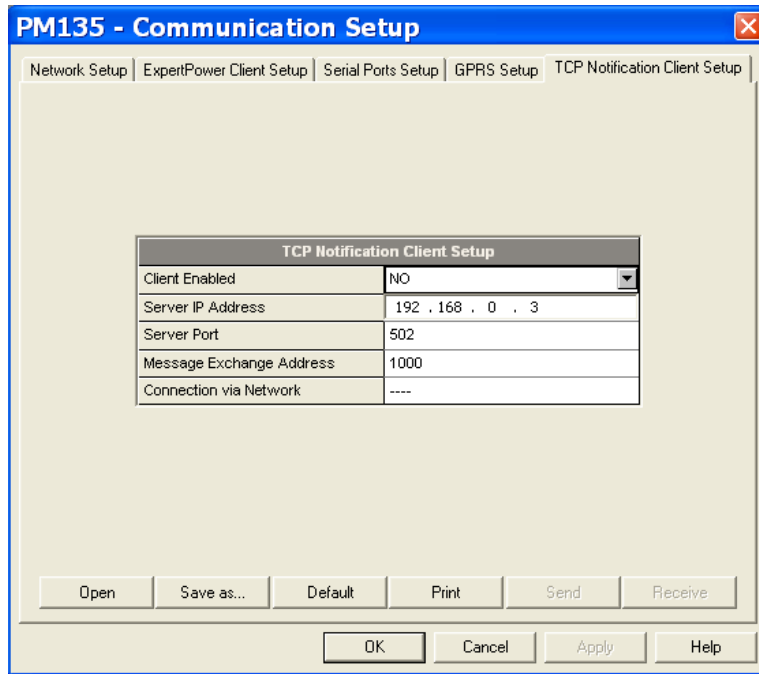

Figure 5-5: TCP Notification Client Setup Tab

The following table lists available client options.

Table 7: TCP Notification Client Setup Options

Parameter	Options	Default	Description
Client Enabled	NO, YES	NO	Enables operations of the notification client
Server IP Address		192.168.0.3	The IP address of the notification server
Server Port	0-65535	502	The TCP service port of the notification server
Message Exchange Address	0-65535	1000	The start address of a block of 16 MODBUS registers for receiving notification messages

Connections with a remote server are triggered via programmable setpoints. To send event notifications to a server, configure a setpoint to respond to desired triggers or to periodic time events and put the "Notification" action to the setpoint action list (see [Configuring Alarm/Control Setpoints](#)).

See the PM135 Modbus Reference guide for more information on operation of the notification client and the notification message structure.

5.2 General Meter Setup

Basic Meter Setup

This section describes how to configure the PM135 for your particular environment and application.

Before operating your meter, provide the device with basic information about your electrical network.

Using the Front Display

Select the **Basic Setup** entry from the Device Setup menu. See [Viewing and Changing Setup Options](#) in Chapter 3 for information on configuring parameters via the front display.

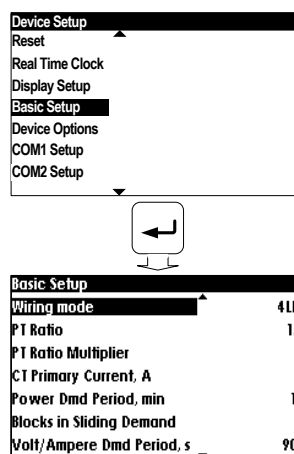

Using PAS

Select **General Setup** from the **Meter Setup** menu. See the table below for the Basic Setup options.

Table 8: Basic Setup Options

Parameter	Options	Default	Description
Basic Configuration			
Wiring Mode	See Table 9	4Ln3	The wiring connection of the device
PT Ratio	1.0-6500.0	1.0	The phase potential transformer's primary to secondary ratio
PT Ratio Multiplier	×1, ×10	×1	PT Ratio multiplication factor. Used in extra high voltage networks to accommodate the PT ratio for 500 kV and higher networks.
CT Primary Current	1-50000 A	5 A	The primary rating of the phase current transformer
Nominal Frequency	50,60,25,400 Hz	60 Hz	The nominal line frequency
Maximum Demand Load Current	0-50000 A	0	The maximum demand load current (0 = CT primary current)
Power block demand period ^{E, EH}	1, 2, 3, 5, 10, 15, 20, 30, 60 min, E=external sync	15 min	The length of the demand period for power demand calculations. If the external synchronization is selected, a pulse front on the digital input DI1 denotes the start of the demand interval.
The number of blocks in the sliding demand window ^{E, EH}	1-15	1	The number of blocks to be averaged for sliding window demands

Parameter	Options	Default	Description
Volt/Ampere Demand Period	0-1800 sec	900 sec	The length of the demand period for ampere and volt demand calculations

1. Always specify the wiring mode and transformer ratings prior to setting up setpoints and analog outputs.
- ⚠ 2. The maximum value for the product of the phase CT primary current and PT ratio is 57,500,000. If the product is greater, power readings are zeroed.

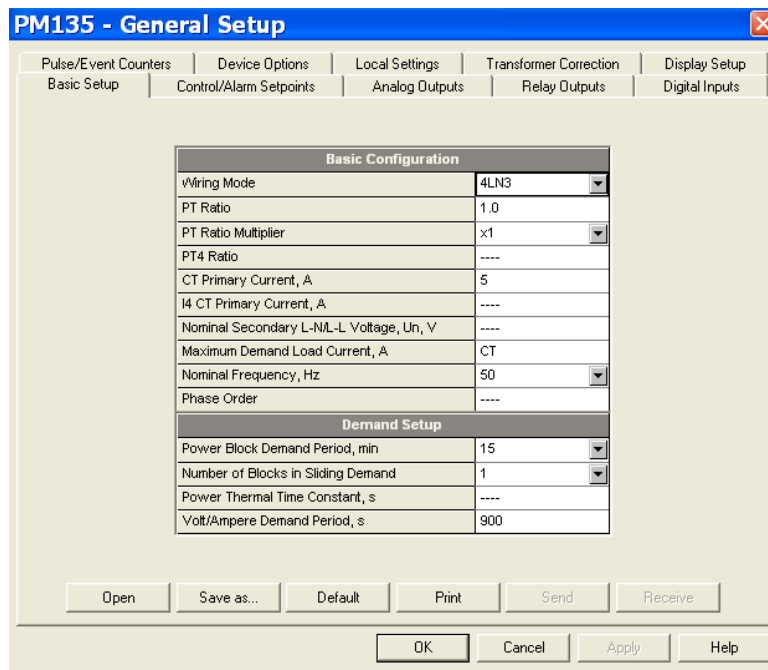

Figure 5-6: General Setup Dialog Box – Basic Setup Tab

Table 9 lists the available wiring modes.

Table 9: Wiring Modes

Wiring Mode	Description
3OP2	3-wire Open Delta using 2 CTs (2 element)
4LN3	4-wire Wye using 3 PTs (3 element), line-to-neutral voltage readings
3DIR2	3-wire Delta Direct Connection using 2 CTs (2 element)
4LL3	4-wire Wye using 3 PTs (3 element), line-to-line voltage readings
3OP3	3-wire Open Delta using 3 CTs (2½ element)
3LN3	4-wire Wye using 2 PTs (2½ element), line-to-neutral voltage readings
3LL3	4-wire Wye using 2 PTs (2½ element), line-to-line voltage readings
3BLN3	3-wire Broken Delta using 2 PTs, 3 CTs (2½ element), line-to-neutral voltage readings
3BLL3	3-wire Broken Delta using 2 PTs, 3 CTs (2½ element), line-to-line voltage readings

⚠ In 4LN3, 3LN3 and 3BLN3 wiring modes, Min/Max volts, volt demands and voltage harmonics represent line-to-neutral

voltages; otherwise, they will be line-to-line voltages.

Transformer Correction

While using external CT meter option, transformer correction allows you to compensate ratio and phase angle inaccuracies of the user voltage and current instrument transformers.

The following table lists available options.

Label	Parameter	Options	Default	Description
Ratio V1-V3	V1-V3 voltage transformer ratio correction factor	0.700 to 1.300	1.000	The ratio of the true transformer ratio to the marked ratio.
Angle V1-V3	V1-V3 transformer phase angle error, minutes	-600 to 600	0	The phase displacement, in minutes, between the primary and secondary values. The phase angle of a voltage transformer is positive when the secondary value leads the primary value.
Ratio I1-I3	I1-I3 current transformer ratio correction factor	0.700 to 1.300	1.000	The ratio of the true transformer ratio to the marked ratio.
Angle I1-I3	I1-I3 transformer phase angle error, minutes	-600 to 600	0	The phase displacement, in minutes, between the primary and secondary values. The phase angle of a current transformer is positive when the secondary value leads the primary value.

Using PAS

Select **General Setup** from the **Meter Setup** menu, and then click on the **Transformer Correction** tab.

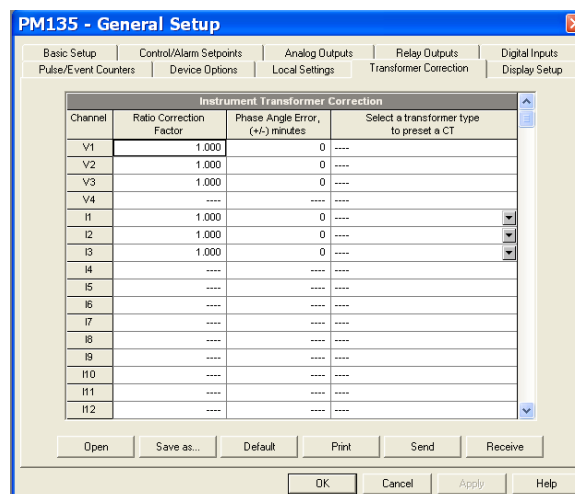

Device Options

The Device Options setup allows changing user-configurable device options or putting the meter into energy test mode.

Using the Front Display

Select **Device Options** from the Device Setup menu. See [Viewing and Changing Setup Options](#) in Chapter 3 for information on configuring parameters via the front display.

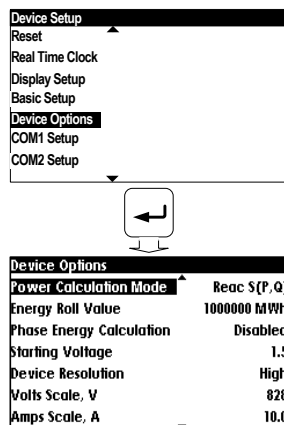

Using PAS

Select **General Setup** from the **Meter Setup** menu, and then click on the **Device Options** tab.

Table 10 lists available device options.

Table 10: User-configurable Device Options

Parameter	Options	Default	Description
Power Calculation Mode	Reac = using reactive power $S=f(P, Q)$, Nact = using non-active power $Q=f(S, P)$	$S=f(P, Q)$	The method used for calculating reactive and apparent powers (see Power Calculation Modes below)
Energy Roll Value E, E_H	10000 kWh 100000 kWh 1000000 kWh 10000000 kWh 100000000 kWh 1000000000 kWh	10000000	The value at which energy counters roll over to zero
Phase Energy Calculation E, E_H	Disabled Enabled	Disabled	Enables phase energy calculations
Energy Test Mode E, E_H	Disabled Wh pulses varh pulses	Disabled	Setting this option puts the meter into the energy test mode (see Energy Pulse LED in Chapter 3)
Starting Voltage	1.5-5.0%	1.5%	The device starting voltage in percent of FS (120V or 400V)
Device Resolution	Low High	Low	The voltage, current and power resolution on the front display (see Measurement Units in Chapter 3) and in communications (see communication guides)
Volts Scale, V	60-828 V	144 V	The maximum voltage scale allowed, in secondary volts. See Data Scales in Appendix F

Parameter	Options	Default	Description
Amps Scale, A	1.0-10.0 A	2 × CT secondary	The maximum current scale allowed, in secondary amps. See Data Scales in Appendix F

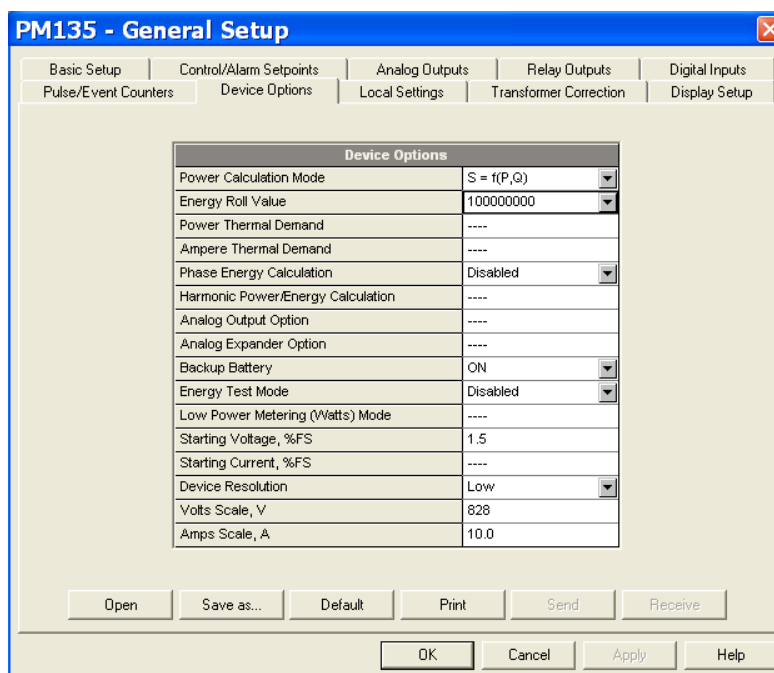

Figure 5-7: General Setup Dialog Box – Device Options Tab

Power Calculation Modes

The power calculation mode option allows you to change the method for calculating reactive and apparent powers in presence of high harmonics. The options work as follows:

- When the reactive power calculation mode is selected, active and reactive powers are measured directly and apparent power is calculated as:

$$S = \sqrt{P^2 + Q^2}$$

This mode is recommended for electrical networks with low harmonic distortion, commonly with THD < 5% for volts, and THD < 10% for currents. In networks with high harmonics, the second method is preferable.

- When the non-active power calculation mode is selected, active power is measured directly, apparent power is taken as product $S = V \times I$, where V and I are the RMS volts and amps, and reactive power (called non-active power) is calculated as:

$$N = \sqrt{S^2 - P^2}$$

Configuring Digital Inputs

The PM135 can be provided with four to twelve (depend on DI/O module type) digital inputs that can be linked to control setpoints to give an indication on input status change (see [Configuring Alarm/Control](#)

[Setpoints](#)), or can be linked to general pulse counters to count incoming pulses (see [Configuring Counters](#)). They can also be linked to the Billing/TOU registers to count pulses from external wattmeters or gas and water meters.

Using PAS

Select **General Setup** from the **Meter Setup** menu, and then click on the **Digital Inputs** tab.

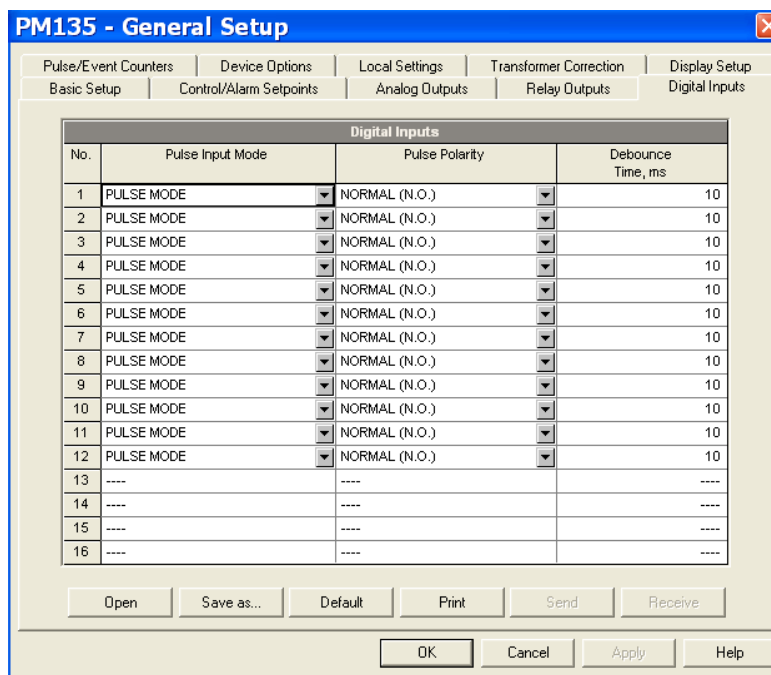

Figure 5-8: General Setup Dialog Box – Digital Inputs Dialog Box

The available options are shown in Table 11.

Table 11: Digital Input Options

Parameter	Options	Default	Description
Pulse Input Mode	PULSE MODE KYZ MODE	PULSE MODE	In pulse mode, either leading, or trailing edge of the input pulse is recognized as an event. In KYZ mode, both leading and trailing edges of the input pulse are recognized as separate events.
Pulse Polarity	NORMAL (N.O.), INVERTING (N.C.)	NORMAL	For the normal polarity, the open to closed transition is considered a pulse. For the inverting polarity, the closed to open transition is considered a pulse. It has no meaning in KYZ mode where both transitions are used.
Debounce Time	1-100 ms	10 ms	The amount of time while the state of the digital input should not change to be recognized as a new state. Too low debounce time could produce multiple events on the input change.

The debounce time is applied the same for all digital inputs. If you change the debounce time for a digital input, the same debounce time is automatically assigned to the others.

Configuring Relay Outputs

The PM135 can be provided with two to four (depend on DI/O module type) optional relay outputs. Each relay can be operated either locally from the alarm/control setpoints in response to an event or by a remote command sent through communications. It can also be linked to an internal pulse source to produce energy pulses.

Using PAS

Select **General Setup** from the **Meter Setup** menu, and then click on the **Relay Outputs** tab.

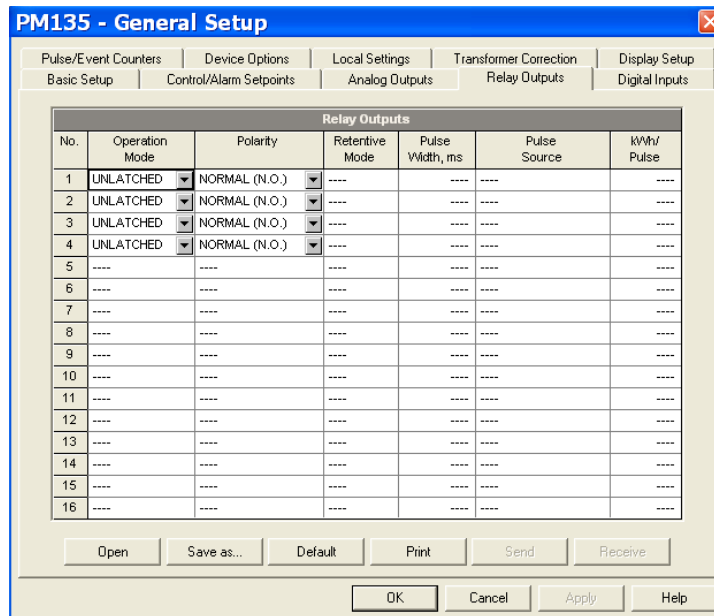

Figure 5-9: General Setup Dialog Box – Relay Outputs Tab

The available relay outputs options are shown in Table 12.

Table 12: Relay Output Options

Parameter	Options	Default	Description
-----------	---------	---------	-------------

Parameter	Options	Default	Description
Operation mode	UNLATCHED LATCHED PULSE KYZ pulse	UNLATCHED	Unlatched mode: the relay goes into its active state when the control setpoint is in active (operated) state, and returns into its non-active state when the setpoint is released. Latched mode: the relay goes into its active state when the control setpoint goes into active state and remains in the active state until it is returned into its non-active state by a remote command. Pulse mode (normal pulse): the relay goes into its active state for the specified time, goes into non-active state for the specified time and remains in the non-active state. KYZ mode (transition pulse): the relay generates transition pulses. The relay changes its output state upon each command and remains in this state until the next command.
Polarity	NORMAL (N.O.) INVERTING (N.C.)	NORMAL	Normal polarity: the relay is normally de-energized in its non-active state and is energized in its active (operated) state. Inverting polarity: the relay is normally energized in its non-active state and is de-energized in its active (operated) state. It is called failsafe relay operation.
Pulse width	20-1000 ms	100 ms	The actual pulse width is a multiple of the 1-cycle time rounded to the nearest bigger value. The pause time between pulses is equal to the pulse width.
Pulse source	NONE kWh IMP kWh EXP kvarh IMP kvarh EXP kvarh TOT AkVAh TOT	NONE	Links a pulse relay to the internal energy pulse source. The relay must be set into either pulse, or KYZ mode.
Pulse rate, kWh/Pulse	0.1-1000.0	1.0 kWh/Pulse	Defines the pulse weight in kWh units per pulse

Generating Energy Pulses through Relay Outputs

To generate energy pulses through a relay output:

1. Set a relay to either pulse, or KYZ mode, and then select a polarity (active pulse edge) for energy pulses and a pulse width.
2. Select a source energy accumulator and the pulse rate for your output.
3. Send your new setup to the meter.

Configuring Analog Outputs

The meter can be ordered with two optional analog outputs with options for 0-1mA, ± 1 mA, 0-20mA and 4-20mA current outputs.

Using PAS

Select **General Setup** from the **Meter Setup** menu, and then click on the **Analog Outputs** tab.

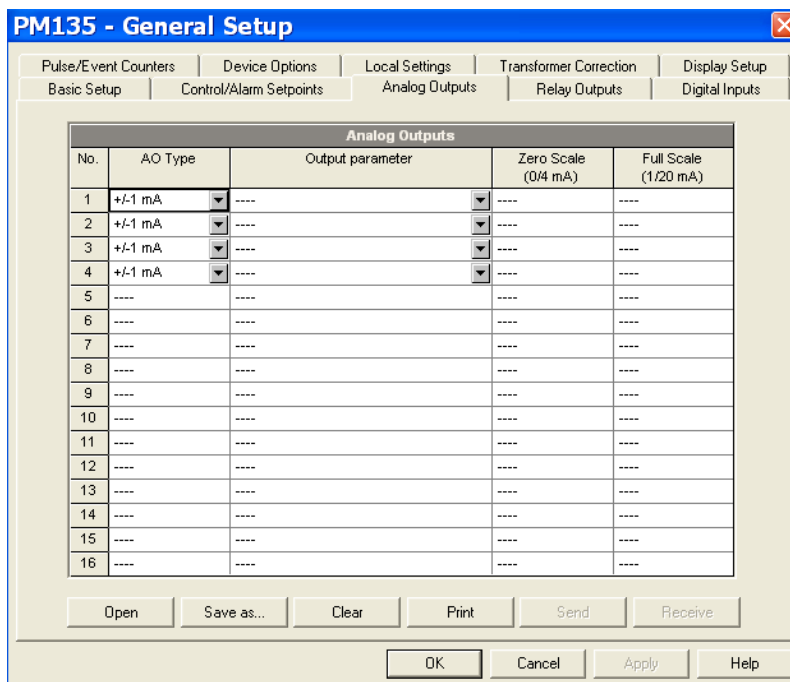

Figure 5-10: General Setup Dialog Box – Analog Outputs Tab

The available analog output options are described in Table 13.

Table 13: Analog Output Options

Option	Range	Description
AO type	0-1mA ±1mA 0-20mA 4-20mA	The analog output type. When connected to the meter, shows the actual AO type received from the device. When working off-line, select the analog output option corresponding to your analog module.
Output parameter	See Appendix B	Selects the measured parameter to be transmitted through the analog output channel.
Zero scale		Defines the low engineering scale (in primary units) for the analog output corresponding to a lowest (zero) output current (0 or 4 mA)
Full scale		Defines the high engineering scale (in primary units) for the analog output corresponding to a highest output current (1 or 20 mA)

When you select an output parameter for the analog output channel, the default engineering scales are set automatically. They correspond to the maximum available scales. If the parameter actually covers a lower range, you can change the scales to provide a better resolution on an analog output.

Scaling Non-Directional Analog Outputs

For non-directional analog outputs with a 0-1mA, 0-20mA or 4-20mA current option, you can change both zero and full engineering scales for any parameter. The engineering scale need not be symmetrical.

Scaling Directional Power Factor

The engineering scale for the signed power factor emulates analog power factor meters.

The power factor scale is -0 to +0 and is symmetrical with regard to ± 1.000 ($-1.000 \equiv +1.000$). The negative power factor is scaled as -1.000 minus the measured value, and non-negative power factor is scaled as $+1.000$ minus the measured value. To define the entire power factor range from -0 to +0, the default scales are specified as -0.000 to 0.000 .

Scaling ± 1 mA Analog Outputs

Programming engineering scales for directional ± 1 mA analog outputs depends on whether the output parameter represents unsigned (as volts and amps) or signed (as powers and power factor) values.

For an unsigned output value, you can change both zero and full engineering scales.

For a signed (directional) value, you should only provide the engineering scale for the +1 mA output current.

The engineering scale for the 0 mA output current is always equal to zero for all values except the signed power factor, for which it is set to 1.000 (see [Scaling Directional Power Factor](#) above).

The meter does not allow access to the low scale setting if the parameter is directional. Whenever the sign of the output parameter is changed to negative, the meter automatically uses the full engineering scale setting for +1 mA with a negative sign.

Scaling Analog Outputs for 0-2 mA and ± 2 mA

The 0-1 mA and ± 1 mA current outputs provide a 100% overload, and actually output currents up to 2 mA and ± 2 mA whenever the output value exceeds the engineering scale you set for the 1 mA or ± 1 mA.

The output scales for 0-1 mA and ± 1 mA analog outputs are programmed for 0 mA and +1 mA regardless of the required output current range.

To use the entire output range of 2 mA or ± 2 mA, set the analog output scales as follows:

- **0-2 mA:** set the 1 mA scale to $\frac{1}{2}$ of the required full scale output for uni-directional parameters, and set the 0 mA scale to the negative full scale and the 1 mA scale to zero for bi-directional parameters.
- **± 2 mA:** set the 1 mA scale to $\frac{1}{2}$ of the required full-scale output for both uni-directional and bi-directional parameters.

For example, to provide the 0 to 2 mA output current range for Volts measured by the meter in the range of 0 to 120V, set the 1 mA scale to 60V; then the 120V reading will be scaled to 2 mA.

Configuring Counters

The PM135 has four six-digit general counters that can count pulses delivered through the device digital inputs with a programmable scale factor. Each counter can also be incremented in response to any internal or external event, checked and cleared through the Control Setpoints.

Using PAS

Select **General Setup** from the **Meter Setup** menu, and then click on the **Pulse/Event Counters** tab.

Table 14 lists available counter options.

Table 14: Counter Options

Option	Range	Default	Description
Pulse Input	None, DIGITAL INPUT #1 - #12	None	Links a digital input to the counter
Multiplier	1-9999	1	The value added to the counter when a pulse is detected on the pulse source input
Counter Value			Displays the present counter contents

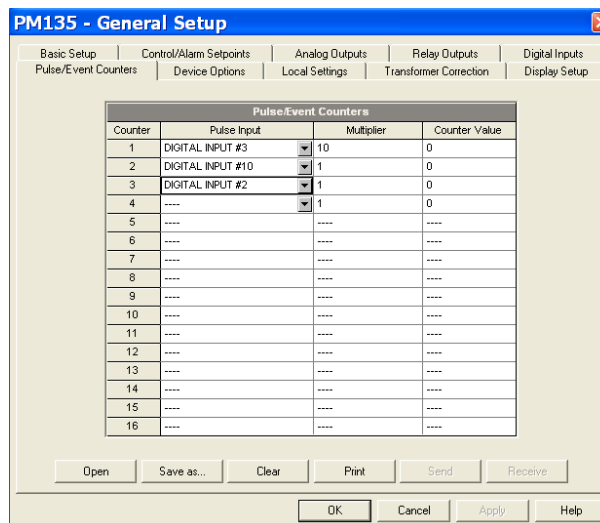
**Figure 5-11: General Setup Dialog Box – Pulse/Event Counters**

You can preset a counter to a required value or clear it without affecting the counter setup.

To preset or clear a counter:

1. Click the Online button on the PAS toolbar before accessing the setup dialog box.
2. Type in the required value into the **Counter Value** field.
3. Click **Send**

Configuring Alarm/Control Setpoints

The PM135 has an embedded logical controller that can perform different actions in response to user-defined internal and external events. Unlike a PLC, the meter uses a simplified programming technique based on setpoints that allows the user to define a logical expression based on measured analog and digital values that produce a required action.

The meter provides 16 control setpoints with programmable operate and release delays. Each setpoint evaluates a logical expression with one trigger argument. Whenever an expression is evaluated as “true”, the setpoint performs a programmable action that can send a command to the output relay, or increment a counter.

The logical controller provides very fast response to events. The scan time for all setpoints is 1 cycle time (16.6 ms at 60Hz and 20 ms at 50/400 Hz).

Using the Front Display

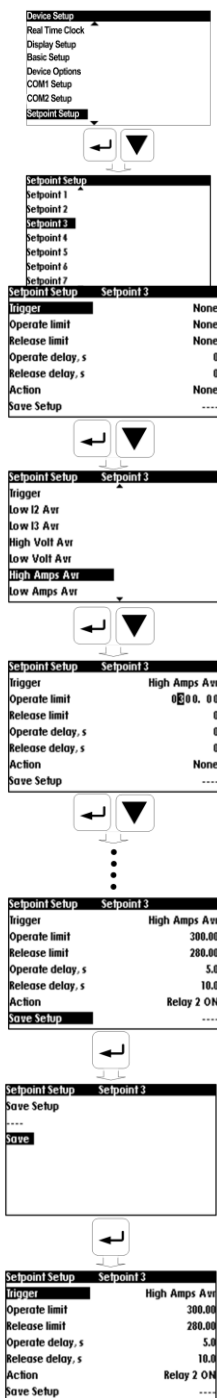

Select **Setpoint Setup** menu from the **Device Setup** menu to enter the setup menu. See [Viewing and Changing Setup Options](#) in Chapter 3 for information on configuring parameters via the front display.

Use the **UP/DOWN** buttons to scroll to the required setpoint.

To select a setpoint parameter:

1. Press **SELECT/ENTER** button to select required setpoint.
2. Use the **UP/DOWN** buttons to scroll to the required parameter.

To change the parameter value:

1. Press **SELECT/ENTER** button to enter the parameter options menu.
2. Use the **UP/DOWN** buttons to select the required value.
3. Press **SELECT/ENTER** button to confirm the new setting

To store your new setpoint settings after you configured all setpoint parameters:

1. SELECT Save Setup function from Setpoint Setup menu and press **SELECT/ENTER** button to enter Save Setup menu

You are returned to the upper window and can select another setpoint or exit the menu.

2. SELECT Save and press **SELECT/ENTER** button to Save Setpoint parameters.

Using PAS

Select **General Setup** from the **Meter Setup** menu, and then click on the **Control/Alarm Setpoints** tab.

The following table lists the available setpoint options.

Table 15: Setpoint Options

Option	Range	Description
Trigger parameter	See Appendix C	The trigger parameter that is used as an argument in the logical expression
Operate limit		The threshold (in primary units) at which the conditional expression would be evaluated to true. Not applicable for digital triggers.

Option	Range	Description
Release limit		The threshold (in primary units) at which the conditional expression would be evaluated to false. Defines the hysteresis for analog triggers. Not applicable for digital triggers.
Operate delay	0.1-999.9 sec	The time delay before operation when the operate conditions are fulfilled
Release delay	0.1-999.9 sec	The time delay before release when the release conditions are fulfilled
Action	See Appendix C	The action performed when the setpoint expression is evaluated to true (the setpoint is in operated state)

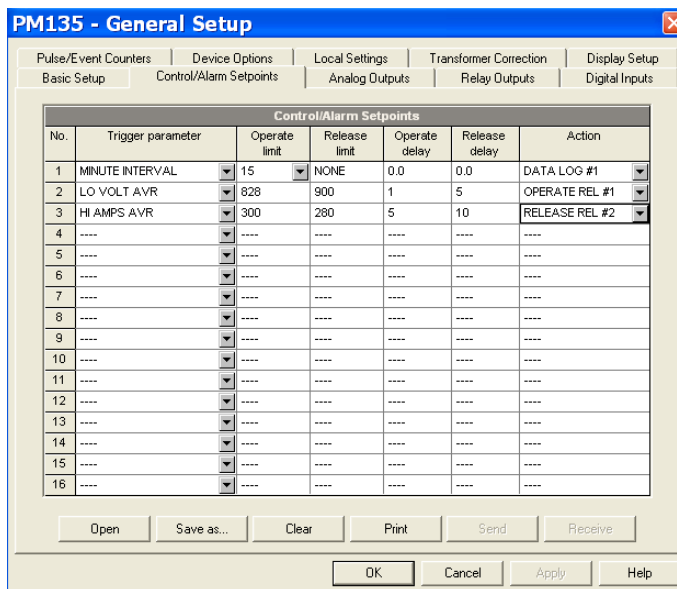

Figure 5-12: General Setup Dialog Box – Control/Alarm Setpoints Tab

Using Numeric Triggers

For numeric (analog) triggers, you can specify two thresholds for each trigger to provide hysteresis (dead band) for setpoint operations.

The Operate Limit defines the operating threshold, and the second Release Limit defines the release threshold for the trigger. The trigger thresholds are specified in primary units.

If you do not want to use hysteresis for the trigger, set the Release Limit to the same value as the Operate Limit.

Using Binary Triggers

Binary (digital) triggers like digital inputs and relays are tested for ON/CLOSED or OFF/OPEN status.

In the PM135, the binary events are level-sensitive events. An event is asserted all the time while the corresponding condition exists.

Delaying Setpoint Operations

Two optional delays can be added to each setpoint to extend monitoring triggers for a longer time before reaching a decision on whether the expected event occurred or not. When a delay is specified, the logical controller changes the setpoint status only if all conditions are asserted for a period of at least as long as the delay time.

Using Setpoint Events and Actions

When a setpoint status changes, i.e., a setpoint event is either asserted or de-asserted, the following happens in your meter:

- The new setpoint status is logged to the setpoint status register that can be monitored through communications from the SCADA system or from a programmable controller in order to give an indication on the expected event.
- The operated setpoint status is latched to the setpoint alarm latch register that can be inspected through communications and via the display (see [Status Display](#) in Chapter 3). The register holds the last setpoint alarm status until it is explicitly cleared through communications or via the display.
- A programmable action is performed on setpoint status transition when a setpoint event is asserted.

Generally, setpoint actions are performed independently for each setpoint and can be repeated a number of times for the same target. The exceptions are relay operations that are shared for each target relay between all setpoints using an OR scheme.

A relay output is operated when one of the setpoints linked to the relay is activated and remains operated until all of these setpoints are released (except for latched relays that require a separate release command to be deactivated).

Using Time Counters

Any of the general counters can be used to count the setpoint operation time. If you select the **TIME CNT n** action for a setpoint, the target counter measures the time while the setpoint is in the operated state. The counter resolution is 0.1 hour. See [Status Display](#) in Chapter 3 on how to examine the counters via the front display.

Configuring the Display

This setup allows configuring the meter display.

Using the Front Display

Select the **Display Setup** entry from the Device Setup menu. See [Viewing and Changing Setup Options](#) in Chapter 3 for information on configuring parameters via the front display.

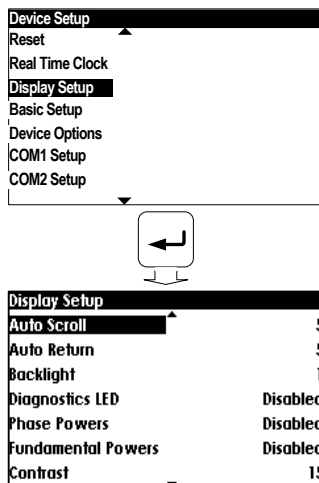

Table 16: Display Setup Options

Display	Parameter	Options	Default	Description
Auto Scroll	Auto Scroll interval	None, 2-15 sec	None	Defines the scroll interval for the main data display or disables auto scroll
Auto Return	Auto Return to Data Display screen	diS = disabled, En = Enabled	Enabled	Enables automatic return to the main display if no buttons are pressed for 5 minutes
Backlight	Display Backlight	Continuous, 1-10 min.	1	Defines the backlight duration to be "ON" in idle operation
Diagnostics LED	Diagnostics indication LED	Disabled, Enabled	Disabled	Enables the diagnostic LED
Phase Powers	Phase Powers display mode	Disabled, Enabled	Disabled	Disables or enables phase powers in the main display
Fundamental Powers	Fundamental component display mode	Disabled, Enabled	Disabled	Disables or enables fundamental values in the main display
Contrast	Display Contrast	1-25	15	Sets LCD contrast
Load Bar Scale, A	Reference load current for LED bar graph	0-10,000A (0 = CT primary current)	0	0 Defines the nominal load (100%) level for the bar graph display

Updating the meter Clock

This setup allows you to setup your local date and time

Using Front Display

Select the **Real Time Clock** entry from the Device Setup menu. See [Viewing and Changing Setup Options](#) in Chapter 3 for information on configuring parameters via the front display.

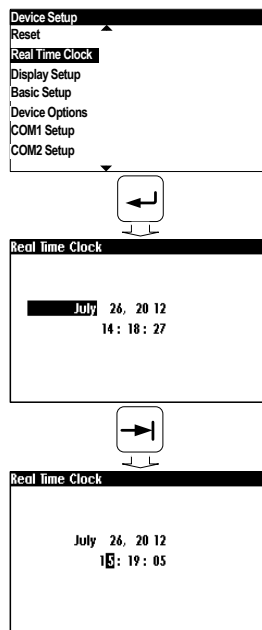

Using PAS

Ensure that the **On-line** button on the PAS toolbar is checked, and then select **RTC** from the **Monitor menu** or click on the PAS toolbar **Real-Time Clock** Button.

The RTC dialog box displays the current PC date and time and the time in your meter.

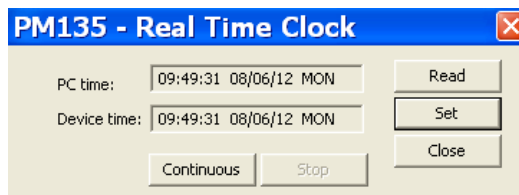

Figure 5-13: Real Time Clock Dialog Box – Time and Date setup

To synchronize the meter clock with the PC clock, click **Set**.

Local Time Settings

This setup allows you to specify your time zone, daylight saving time, and clock synchronization options.

Using the Front Display

Select the **Local Settings** entry from the Device Setup menu. See [Viewing and Changing Setup Options](#) in Chapter 3 for information on configuring parameters via the front display.

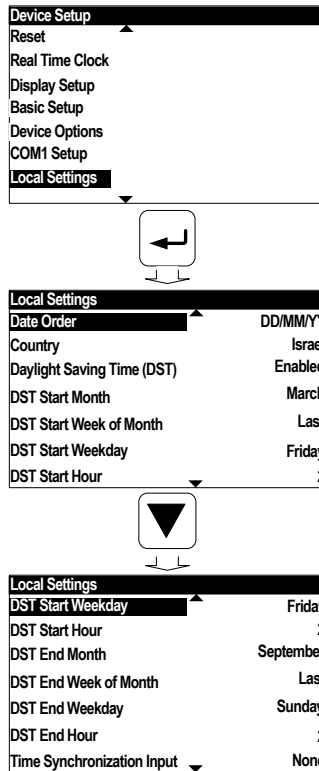

Using PAS

Select **General Setup** from the **Meter Setup** menu, and then click on the **Local Settings** tab.

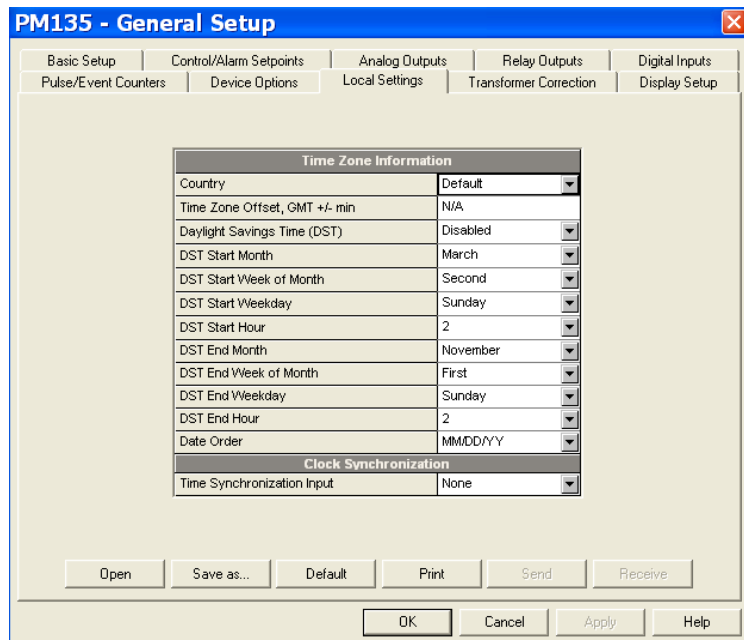

Figure 5-14: General Setup Dialog Box – Local Settings Tab

The available options are described in Table 17.

Table 17: Local Time Options

Display Label	Parameter	Options	Default	Description
Country	Country	Default, or country name	Default	Defines calendar setting. The default setting stands for the U.S.A.
Daylight Saving Time	Daylight Saving Time	Disabled, Enabled	Disabled	When DST is disabled, the RTC operates in standard time only. When enabled, the meter automatically updates the time at the pre-defined DST switch dates.
DST Start Month DST Start Week of Month DST Start Weekday	DST Start Month DST Start Week DST Start Weekday	Jan-Dec Last, 1-4 Monday-Sunday	March Last Sunday	The date when Daylight Saving Time begins.
DST Start Hour	DST Start Hour	1-6	2	The hour when Daylight Saving Time begins.
DST End Month DST End Week of Month DST End Weekday	DST End Month DST End Week DST End Weekday	Jan-Dec Last, 1-4 Monday-Sunday	March Last Sunday	The date when Daylight Saving Time Ends.
DST End Hour	DST End Hour	1-6	2	The hour when Daylight Saving Time begins.
Time Synchronization Input	Time Synchronization Input	None DI1 PPM – DI12 PPM	None	The external port receiving the time synchronization pulses

Daylight Saving Time

When the daylight saving time is enabled, the meter automatically advances the device clock by one hour when daylight saving time begins and puts the clock back one hour when it ends. The default daylight saving time change points are preset for the U.S.A.

The daylight saving time option is disabled in the PM135 by default. If the daylight saving time option is disabled, you need to manually adjust the device clock for daylight saving time.

Time Synchronization Pulses

External time synchronization pulses can be delivered through one of the digital inputs.

If a digital input is selected as the time synchronization source, the edge of an external pulse adjusts the device clock at the nearest whole minute. The time accuracy could be affected by the debounce time of the digital input, and by the operation delay of the external relay.

5.3 Configuring Meter Security

This setup allows changing the user password and enabling or disabling password protection.

The password in your meter is preset to 0 at the factory, and password protection is disabled.

Using the Front Display

Select the **Password Setup** entry from the Device Setup menu. See [Viewing and Changing Setup Options](#) in Chapter 3 for information on configuring parameters via the front display.

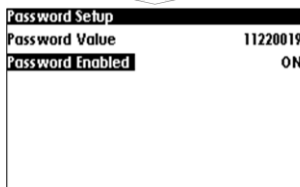
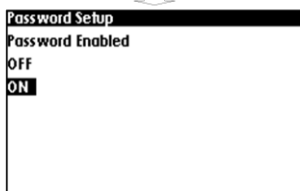
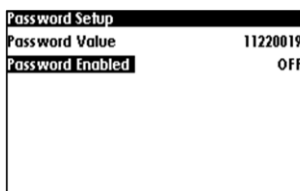
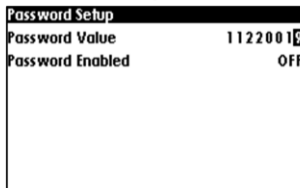
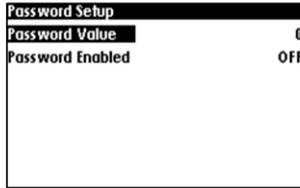
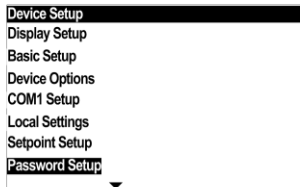

To change the password:

1. Select the **Password Setup** entry from the Device Setup menu using the **UP/ DOWN** buttons.
2. Press the **ENTER** button to enter the "Password Setup" menu.
3. Select "Password Value" with the **UP /DOWN** and **ENTER** buttons to access the password value field.
4. select the desired digit using the **UP/DOWN** button and move to next digit by pressing the **TAB** button
5. Press **ENTER** button when desired password value is achieved that returns to "Password Value" field



The new password is effective for both the display and communication ports.

To enable or disable password protection:

1. Select "Password Enabled" field using the **UP /DOWN** buttons.
2. Press the **ENTER** button to enter the "OFF/ON Password Enabled" display.
3. Use the **UP/DOWN** buttons to select the option:
 - ON** enables password protection and
 - OFF** disables password protection.
4. Press **ENTER** to confirm your new setting.
5. Press **ESC** to exit the menu.



When password protection is enabled, you are not able to change the device settings through the display or communications unless you provide a correct password.

If you cannot provide a proper password, contact your local distributor for the appropriate password to override password protection.

Using PAS

Ensure that the **On-line** button on the PAS toolbar is checked, select **Administration** from the **Monitor** menu, and then select **Change Password -> Password 1**.

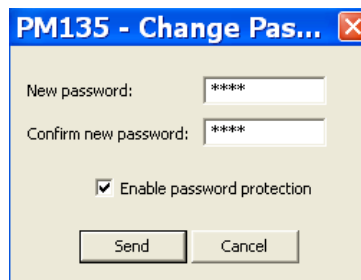

Figure 5-15: Password Setup Dialog Box

To change the password:

1. Type in a new 4-digit password
2. Repeat the password in the **Confirm new password** box
3. Check **Enable password protection** to enable password checking
4. Click **Send**.

5.4 Configuring Billing/TOU

The TOU battery-backed clock unit is highly recommended in case of using time-scheduled tariff rates, otherwise a long power outage may cause the meter clock to lose time so your tariff counters would not comply with the calendar schedule.

Billing Energy Registers

The PM135E/EH has 4 fully programmable billing energy registers that can be linked to any internal energy source or to an external pulse source that delivers pulses through the meter digital inputs.

Any energy register can provide either a single-tariff energy accumulation or be individually linked to the TOU system providing both total and multi-tariff energy billing.

Tariff Rates

The meter tariff structure supports 8 different tariff rates using an arbitrary tariff schedule. A total of 4 types of days and 4 seasons are supported with up to eight tariff changes per day.

Maximum Demand Registers

Any of billing energy registers can be individually linked to the maximum demand register providing the same demand tariff structure as you selected for energy registers.

Recording Billing Data and Load Profiling

The PM135E/EH can provide automatic recording of the daily energy and maximum demand profile to a data log file. Maximum demand profiling can be individually configured for every register.

See [Factory Preset Data Log Files](#) in Chapter 5 and [Billing Profile Log File](#) in Appendix E for more information on the file layout and contents.

To configure the billing registers and the tariff system in your meter:

1. Link the billing registers to the respective energy sources.
2. Configure the options for the registers to whether the only totalization or both total and tariff registers would be used, and whether daily profiling should be enabled for the energy usage and maximum demand registers.
3. Configure the daily tariff schedule using the TOU daily profiles for all types of days and seasons.
4. Configure the season tariff schedule using the TOU calendar.

Configuring Billing/Tariff Registers

To configure the billing/TOU registers in your meter:

1. Select **Energy/TOU** from the **Meter Setup** menu.

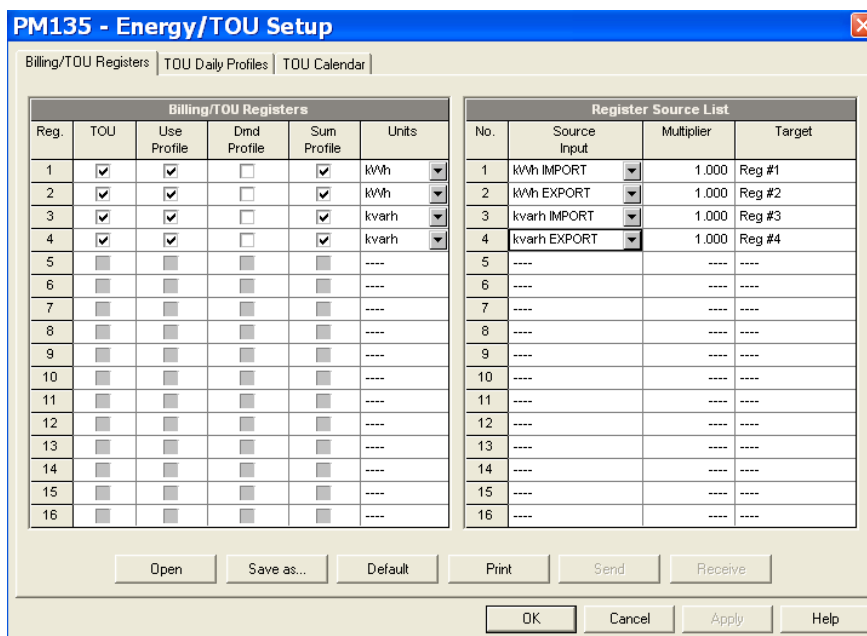

Figure 5-16: Energy/TOU Setup Dialog Box – Billing/TOU Registers tab

2. Configure the register options according to the valid parameters shown in Table 18.

Table 18: Billing/TOU Register Options

Parameter	Options	Default	Description
Billing/TOU Registers			
TOU	Unchecked Checked	Unchecked	Links tariff registers to the selected energy source
Use Profile	Unchecked Checked	Checked	Enables recording energy registers in a daily billing profile file (both total and tariff registers if TOU is enabled).
Dmd Profile	Unchecked Checked	Unchecked	Enables recording maximum demand registers in a daily billing profile file (both total and tariff registers if TOU is enabled)
Sum Profile	Unchecked Checked	Checked	Enables recording total (summary) registers in a daily billing profile file.
Units	kWh, kvarh, kVAh, m ³ , CF (cubic foot), CCF (hundred cubic feet)	None	The register measurement units. When a register is linked to an internal energy source, it is set automatically. When an external pulse source is used, the user can select a measurement unit for the register.
Register Source List			
Source Input	None kWh Import kWh Export kvarh Import kvarh Export kVAh, DI1-DI12	None	Links an energy source to the register
Multiplier	0.001 to 100.000	1.000	The multiplication factor for the energy source. Unchangeable for internal energy sources.
Target	Reg# 1- Reg#4	None	Defines the target billing register for the energy source. It is set automatically.

Configuring the Daily Tariff Schedule

To configure your daily tariff schedule, select **Energy/TOU** from the **Meter Setup** menu, and then click on the **TOU Daily Profiles** tab.

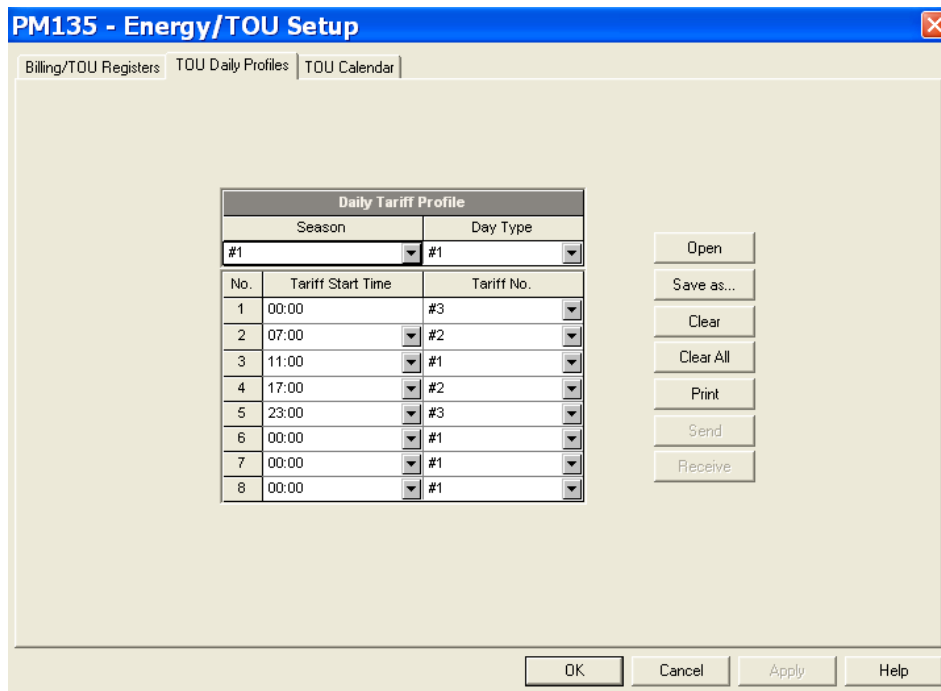

Figure 5-17: Energy/TOU Setup Dialog Box – TOU Daily Profiles Tab

The daily profile setup allows you to specify the daily tariff change points with a 15-minute resolution for 4 seasons using 4 different daily schedules for each season.

To configure your daily profiles:

1. Select the desired season and day type.
2. Select the start time for each tariff change point and the corresponding active tariff number.
3. Repeat the setup for all active profiles.

The first tariff change point is fixed at 00:00 hours, and the last tariff change you specified will be in use until 00:00 hours on the next day.

NOTE

The billing daily profile log file is automatically configured for the number of active tariffs you defined in the meter TOU daily profiles.

Configuring the Season Tariff Schedule

To configure your season tariff schedule, select **Energy/TOU** from the **Meter Setup** menu, and then click on the **TOU Calendar** tab.

No.	Season/ Period	Day Type	Week of Month	Weekday	Till Weekday	Month	Day	Till Month	Till Day
1	#1	#1	----	Sunday	Thursday	July	----	August	----
2	#1	#2	----	Friday	----	July	----	August	----
3	#1	#3	----	Saturday	----	July	----	August	----
4	#2	#1	----	Sunday	Thursday	December	----	February	----
5	#2	#2	----	Friday	----	December	----	February	----
6	#2	#3	----	Saturday	----	December	----	February	----
7	#3	#1	----	Sunday	Thursday	March	----	June	----
8	#3	#2	----	Friday	----	March	----	June	----
9	#3	#3	----	Saturday	----	March	----	June	----
10	#3	#1	----	Sunday	Thursday	September	----	November	----
11	#3	#2	----	Friday	----	September	----	November	----
12	#3	#3	----	Saturday	----	September	----	November	----
13	----	----	----	----	----	----	----	----	----
14	----	----	----	----	----	----	----	----	----
15	----	----	----	----	----	----	----	----	----
16	----	----	----	----	----	----	----	----	----

Figure 5-18: TOU Calendar Setup Dialog Box – TOU Calendar Tab

The meter TOU calendar allows you to configure any tariff schedule based on any possible utility regulation. The calendar provides 32 entries that allow you to specify profiles for working days and holidays through all seasons in any order that is convenient for you, based on simple intuitive rules.

To configure your season tariff schedule:

1. In the **Season/Period** box, select the season, and in the **Day Type** box, select a day type for this calendar entry.
2. Define the time interval when this daily tariff schedule is effective, based on the start and end weekdays and, for a multi-season schedule, on the start and end month for the selected season. It does not matter which order of weekdays or months you select: the meter recognizes the correct order.
3. For exception days like weekends and designated holidays, define a specific day either by a month and a month day, or by selecting a month, a week and a weekday within the month.

There are no limitations on how to build your schedule. A common recommendation is to use minimum time constraints and only when it is needed to avoid ambiguity. You need not to define month days if a daily schedule is effective all days of the month, or to define the start and end months if it is effective through all the year. If you wish to define a specific period within a month using the start and end days, put this entry before allocating the remaining days to another daily schedule without specified month days, so it would be checked first for a match.

The above picture shows a typical single-season tariff schedule with two daily tariff profiles configured for working days, and weekends and the designated U.S.A. holidays.

5.5 Configuring Recorders

The PM135E/EH has a 125-KByte onboard non-volatile memory for data and event recording. The memory is fully configurable and can be freely partitioned between log files.

The meter provides memory for a total of 3 log files:

- Event log
- Two data logs

The two data log files are pre-configured at the factory for recording a 15-minute energy and demand profile and for the daily billing energy data profile. If you wish to change the factory settings, follow the guidelines in the next section.

Configuring Meter Memory

To view the present memory settings, select **Memory/Log** from the **Meter Setup** menu, and then click on the **Log Memory** tab.

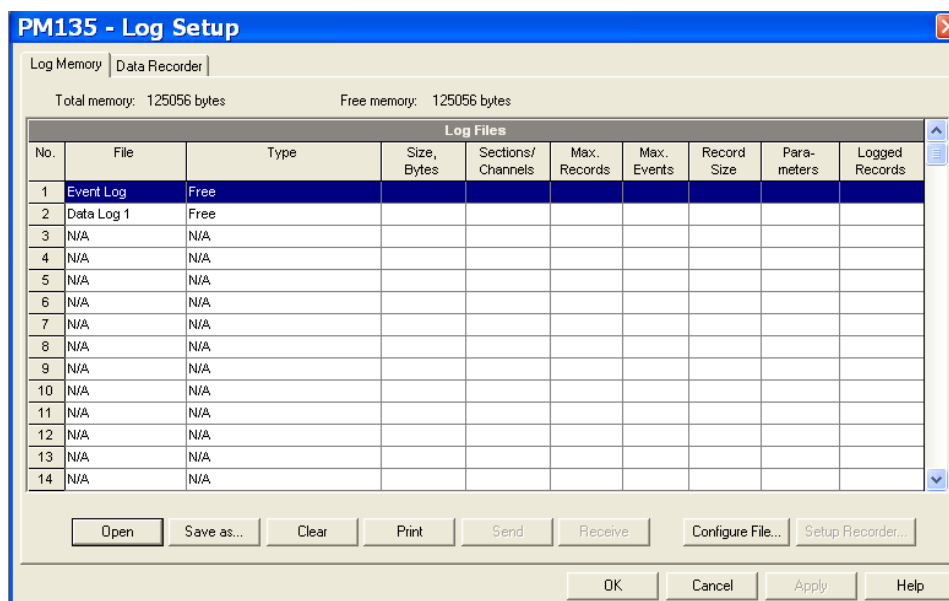

Figure 5-19: Log Setup Dialog Box – Log Memory Tab

The following table describes file options.

Option	Range	Description
Type	Wrap-around Non-wrap	Wrap-around: recording continues over the oldest records. Non-wrap: recording is stopped until the file is cleared.
Size		The size of memory allocated to the file.
Sections/Channels	0-8	The numbers of sections in a multi-section profile data log file
Num. of Records	0-65535	Allocates the file memory for predefined number of records
Record size		The size of the file record for a single channel or a single section. It is set automatically depending on the file and on the number of parameters in the data records
Parameters	0-9	The number of parameters in a single data log record

To change the file properties or to create a new file:

1. Double click on the file you want to change.

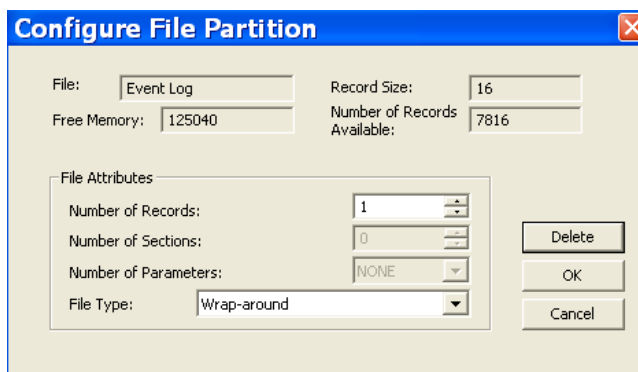

2. Select desired parameters for your log.
3. Click **OK**.

For your reference, the record size and the number of records available for your file are reported in the dialog box.

To delete an existing file partition:

1. Click on **Delete**.
2. Click **OK**.

NOTES

1. Memory is allocated for a file statically when you set up your files and will not change unless you re-organize files.
2. The meter automatically performs de-fragmentation of the memory each time you re-organize your files. This prevents possible leakage of memory caused by fragmentation. It may take a couple of seconds.

For more information on configuring specific files, see the following sections.

The following table can help you calculate an estimated file size when planning your memory allocation.

File	Record Size, Bytes	File Size, Bytes
Event Log	16	Record size × Number of records
Conventional data Log	12 + 4 × Number of parameters	Record size × Number of records
Billing/TOU daily profile log	12 + 4 × (Number of season tariffs + 1 for the TOU summary/total register)	Record size × Number of billing registers (× 2 for the maximum demand profile) × Number of records

The factory pre-set file configuration is shown in the following table.

No.	File	Size, Bytes	Channels	Number of Records	Number of Events	Factory-set Configuration
1	Event log	3200		200	200	200 last events
2	Data log #1	103680		4320	4320	15-min data profile for 15 days
17	Data log #16	8640	4	90	90	Daily billing/TOU profile for 90 days, 4 registers, totals + 3 tariffs

Configuring the Event Recorder

To configure the Event log file:

3. Double click on the Event Log file partition with the left mouse button.

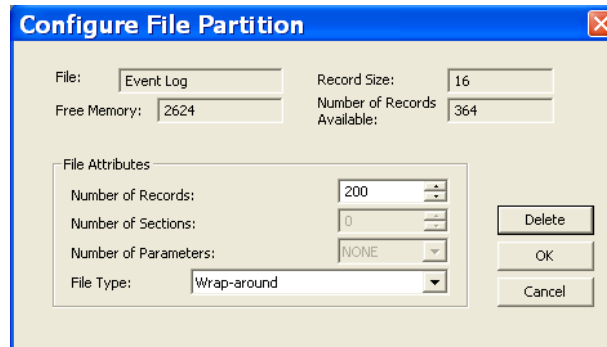

4. Select a desired file type for your file.
5. Select the maximum number of records you want to be recorded in the file.
6. Click OK, then send your new setup to the meter or save to the device database.

By default, the Event recorder stores all events related to configuration changes, resets, and device diagnostics.

Configuring the Data Recorder

Conventional Data Log Files

The Data recorder is programmable for recording up to 9 data parameters per record in each of the conventional data log files. The list of parameters to be recorded to a data log is configurable individually for each file.

To create a new data log file or re-configure an existing file:

1. Double click on the file partition with the left mouse button.

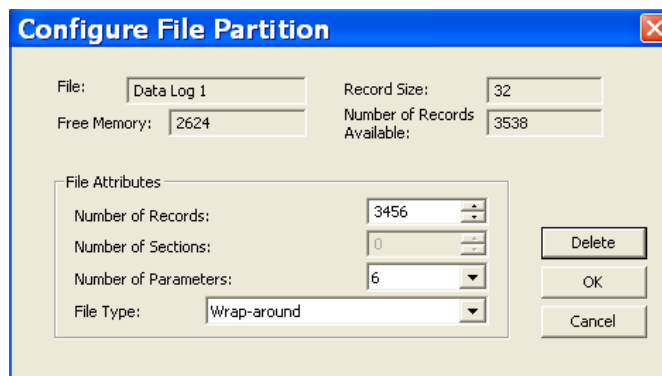

2. Select a partition type for your file.
3. Select the number of parameters you want to be recorded in the file records.

4. Select the maximum number of records you want to be recorded in the file.
5. Click **OK**, and then send your new setup to the meter, or save to the device database.

To define the contents of the file:

1. Highlight the data log file row with the left mouse button, and then click on the **Setup Recorder** button, or click on the **Data Recorder** tab and select the corresponding log number.

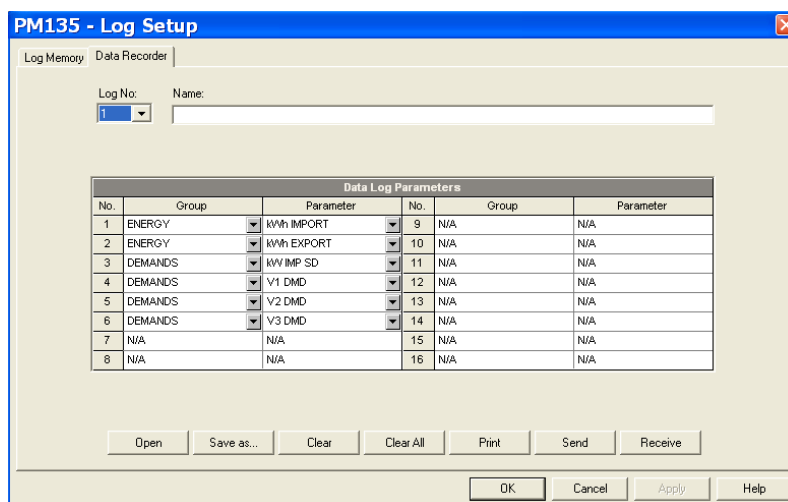

Figure 5-20: Log Setup Dialog Box – Data Recorder Tab

2. Configure the list of parameters to be recorded in a log file. You are not allowed to select more parameters than you defined when configuring your file. Refer to Appendix D for a list of available parameters.
3. For your convenience, PAS follows your selection and helps you configure a series of the neighboring parameters: when you open the **Group** box for the next parameter, PAS highlights the same group as in your previous selection; if you select this group again, PAS automatically updates the **Parameter** box with the following parameter in the group.
4. Add the name for your data log file in the **Name** box. It will appear in the data log reports.
5. Save your new setup to the device database, and send it to the meter.

Billing/TOU Daily Profile Log File

Data log #16 is configurable to store TOU daily profile log records on a daily basis.

The file is organized as a multi-section file that has a separate section of the same structure for each billing energy and maximum demand register. The number of sections is taken automatically from the Billing/TOU Registers setup (see [Configuring Billing/Tariff Registers](#)). If the maximum demand profiling is used, then the number of sections in the file will be twice the number of the allocated billing registers.

To configure a daily profile log file:

1. Configure your Billing/TOU registers and tariff schedule in the meter (see [Configuring Billing/Tariff Registers](#)) first.
2. Double click on the **Data Log#16** partition with the left mouse button.

3. Select the **TOU Daily Profile** file type.
4. Select the number of season tariffs in your TOU schedule. Add one additional parameter if you selected to record the Summary (TOU total) registers as well.
5. Select the maximum number of records you want to be recorded in the file assuming that a new record will be added once a day.
6. Click **OK** and send your setup to the meter or save to the meter database.

Factory Preset Data Log Files

Conventional Data Log #1

Data log #1 is factory preset for 15-min periodic recording of the standard energy and demand quantities. You can freely change the list of recorded parameters and the file update rate.

The default list of parameters is shown in the following table.

No.	Parameter
1	kWh import
2	kWh export
3	kW import sliding demand
4	V1 demand
5	V2 demand
6	V3 demand

Periodic recording data is triggered by Setpoint #1 that is linked to the meter clock. To change the periodic rate at which data is recorded,

change the time interval for the MINUTE INTERVAL trigger in Setpoint #1 (see [Configuring Alarm/Control Setpoints](#)).

Billing/TOU Profile Data Log #16

Data log #16 is pre-configured for daily billing energy and maximum demand recording for the last 90 days. It is automatically updated once a day.

See [Billing Profile Log File](#) in Appendix E for the file record structure.

5.6 Configuring Communication Protocols

This section describes how to customize protocol options for use with your application software.

Configuring Modbus

Modbus Point Mapping

The PM135 provides 120 user assignable registers at addresses 0 to 119. You can re-map any register available in the meter to any assignable register so that registers found at different locations may be accessed with a single request by re-mapping them to adjacent addresses.

Initially these registers are reserved and none of them points to an actual data register. To build your Modbus register map:

1. Select **Protocol Setup** from the **Meter Setup** menu, and click on the **Modbus Registers** tab.
2. Click on the **Default** button to cause the assignable registers to reference the actual default meter register 6656 (0 through 119 are not allowable register addresses for re-mapping).

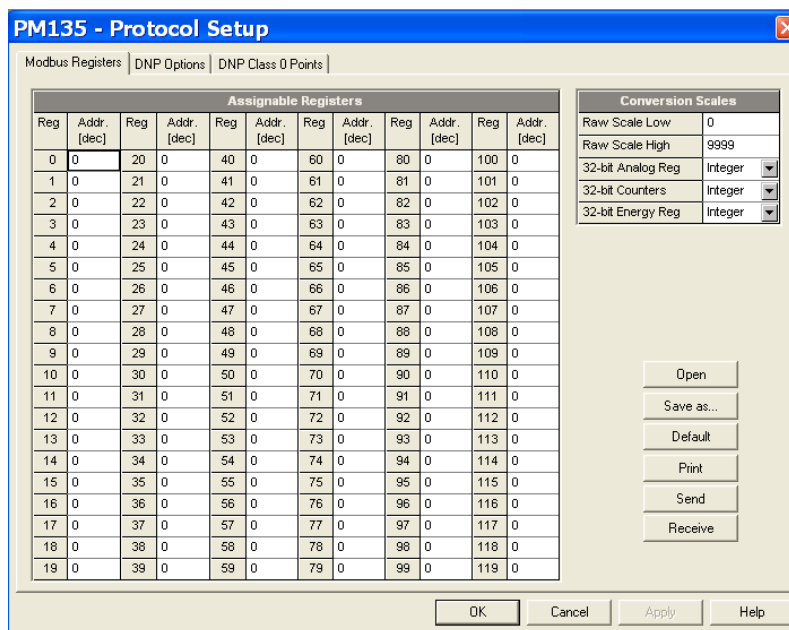

Figure 5-21: Protocol Setup Dialog Box – Modbus Registers Tab

3. Type in the actual addresses you want to read from or write to via the assignable registers. Refer to the PM135 Modbus Reference Guide for a list of the available registers. Note that 32-bit Modbus registers should always start at an even register address.
4. Click **Send** to download your setup to the meter.

Changing 32-bit Register Format

The PM135 allows you to read 32-bit Modbus analog registers, energy counters and binary counters either in integer format, or in IEEE single precision floating point format.

The 32-bit Modbus registers are factory-set to integer format. To change the register format:

1. Select **Protocol Setup** from the **Meter Setup** menu, and click on the **Modbus Registers** tab.
2. Change the 32-bit register format in the **Modbus Options** pane.
3. Click **Send** to download your setup to the meter.

Configuring DNP3

Refer to the PM135 DNP3 Reference guide for information on the DNP3 protocol implementation and a list of the available data points.

DNP Options

Select **Protocol Setup** from the **Meter Setup** menu and click on the **DNP Options** tab.

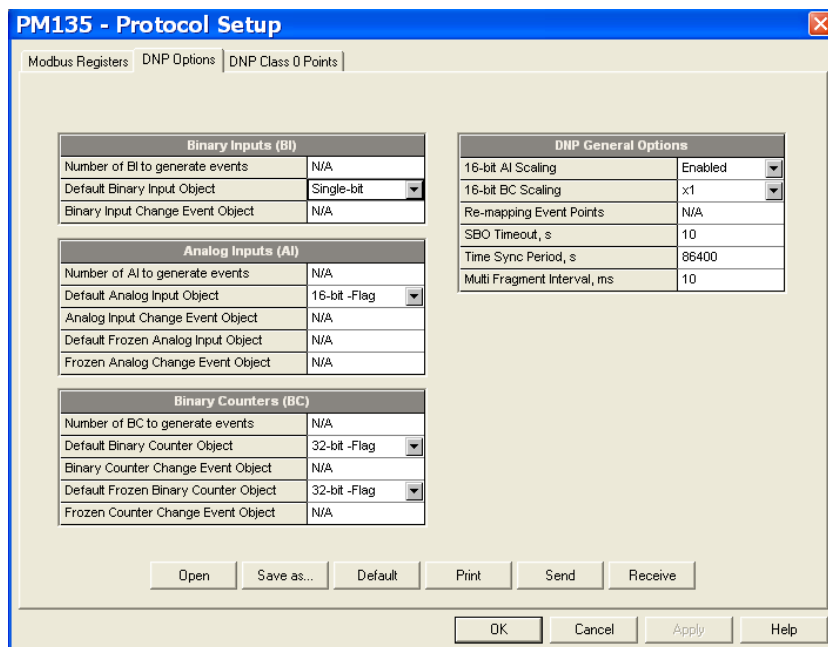

Figure 5-22: Protocol Setup Dialog Box – DNP Options Tab

The following table describes available options. Refer to the DNP3 Data Object Library document available from the DNP User's Group on the DNP3 object types.

Table 19: DNP Options

Parameter	Options	Default	Description
Binary Inputs (BI)			

Parameter	Options	Default	Description
Binary Input Object	Single-bit With Status	Single-bit	The default BI object variation for requests with qualifier code 06 when no specific variation is requested
Analog Inputs (AI)			
Analog Input Object	32-bit 32-bit-Flag 16-bit 16-bit-Flag	16-bit-Flag	The default AI object variation for requests with qualifier code 06 when no specific variation is requested
Binary Counters (BC)			
Binary Counter Object	32-bit+Flag 32-bit-Flag 16-bit+Flag 16-bit-Flag	32-bit-Flag	The default BC object variation for requests with qualifier code 06 when no specific variation is requested
DNP General Options			
16-bit AI Scaling	Disabled Enabled	Enabled	Allows scaling 16-bit analog input objects (see description below)
16-bit BC Scaling	x1, x10, x100, x1000	x1	Allows scaling 16-bit binary counter objects (see description below)
SBO Timeout ²	2-30 sec	10	Defines the Select Before Operate (SBO) timeout when using the Control-Relay-Output-Block object
Time Sync Period ³	0-86400 sec	86400	Defines the time interval between periodic time synchronization requests
Multi Fragment Interval	50-500 ms	50	Defines the time interval between fragments of the response message when it is fragmented

Scaling 16-bit AI objects

Scaling 16-bit AI objects allows accommodating native 32-bit analog input readings to 16-bit object format; otherwise it may cause an over-range error if the full-range value exceeds a 16-bit point limit.

Scaling is enabled by default. It is not related to points that are read using 32-bit AI objects.

Refer to the PM135 DNP3 Reference Guide for information on the data point scales and a reverse conversion that should be applied to the received scaled values.

Scaling 16-bit Binary Counters

Scaling 16-bit Binary Counters allows changing a counter unit in powers of 10 to accommodate a 32-bit counter value to 16-bit BC object format.

If the scaling unit is greater than 1, the counter value is reported being divided by the selected scaling unit from 10 to 1000. To get the actual value, multiply the counter reading by the scaling unit.

Configuring DNP Class 0 Responses

The most common method of getting static object information from the meter via DNP is to issue a read Class 0 request. The PM135 allows you to configure the Class 0 response by assigning ranges of points to be polled via Class 0 requests.

² The Select Before Operate command causes the meter to start a timer. The following Operate command must be sent before the specified timeout value expires.

³ The meter requests time synchronization by bit 4 in the first octet of the internal indication word being set to 1 when the time interval specified by the Time Sync Period elapses. The master should synchronize the time in the meter by sending the Time and Date object to clear this bit. The meter does not send time synchronization requests if the Time Sync Period is set to 0.

To view or build a DNP Class 0 response message:

1. Select **Protocol Setup** from the **Meter Setup** menu and click on the **DNP Class 0 Points** tab.
2. Select the object and variation type for a point range.
3. Specify the start point index and the number of points in the range. Refer to the PM135 DNP3 Reference Guide for available data points.
4. Repeat these steps for all point ranges you want to be included into the Class 0 response.
5. Click **Send** to download your setup to the meter.

The factory-set Class 0 point ranges are shown in the picture below.

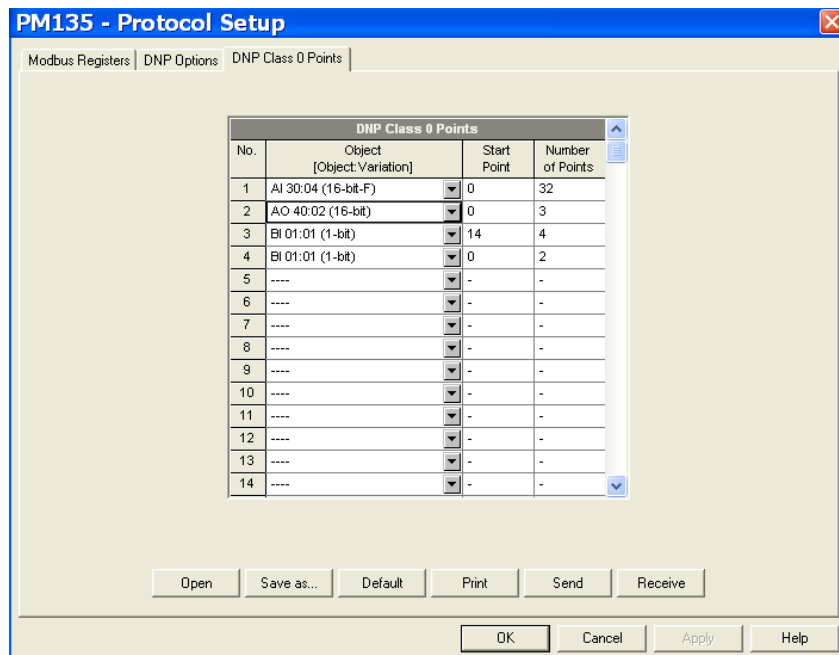

Figure 5-23: Protocol Setup Dialog Box – DNP Class 0 Points Tab

Chapter 6 Device Control and Upgrading

This section describes operations on the meter you can perform from the front display or via PAS. To access device control options from PAS, you should have your meter online.

6.1 Resetting Accumulators, Maximum Values and Files

Using the Front Display

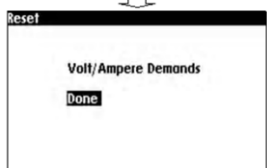
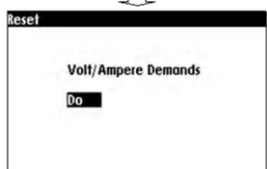
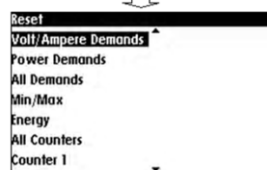
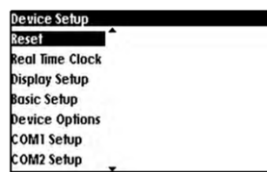

Select the **RESET** entry from the Device Setup menu. See [Viewing and Changing Setup Options](#) in Chapter 3 for information on configuring parameters via the front display.

To reset the desired values:

1. Select the desired parameter to be cleared using the **UP/DOWN** button then press the **ENTER** button.
2. Press the **ENTER** button for approximately 5 sec until the "Do" notification is changed to "Done"

Table 20 shows the reset options available from the front display.

Table 20: Front Display Reset Options

Display Label	Description
Volt/Ampere Demands	Clears ampere and volt maximum demands
Power Demands	Clears power maximum demands
All Demands	Clears all maximum demands
Min/Max	Clears Min/Max log
Energy	Clears all total energies
Counters	Clears all counters
Counter 1	Clears counter #1
Counter 2	Clears counter #2
Counter 3	Clears counter #3
Counter 4	Clears counter #4
Diagnostics	Clears device diagnostics

Using PAS

Ensure that the **On-line** button on the PAS toolbar is checked, and then select **Reset** from the **Monitor menu**.

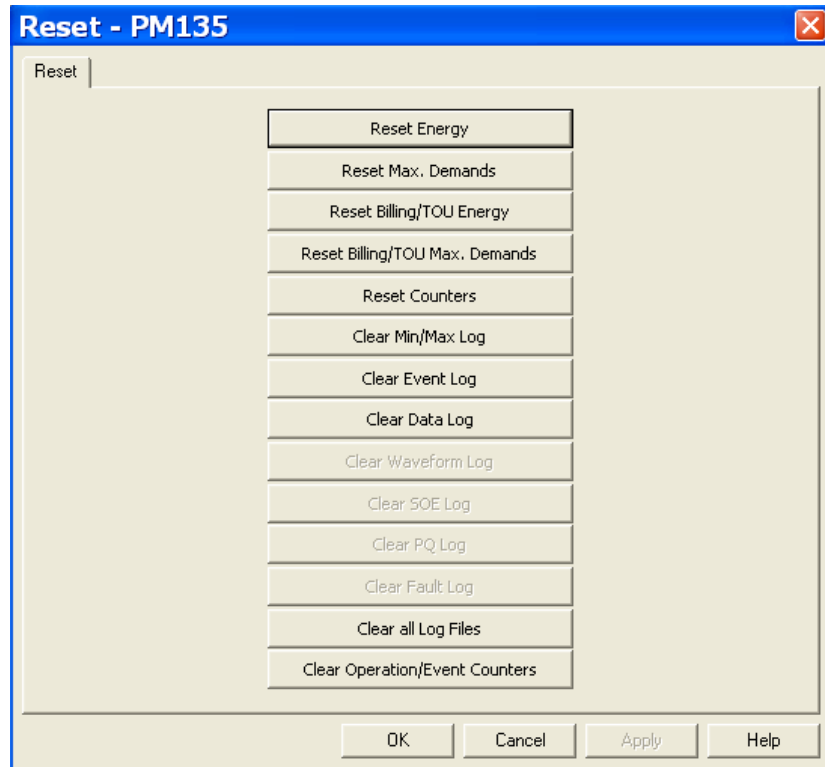

Figure 6-1: Reset Dialog

To reset the desired values or files:

1. Click on the corresponding button, and then confirm your command.
2. If an entry has more than one target, you are allowed to select targets to reset.
3. Check the corresponding boxes, and then click OK.

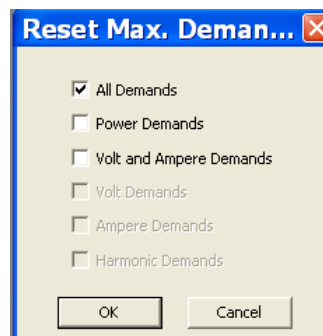
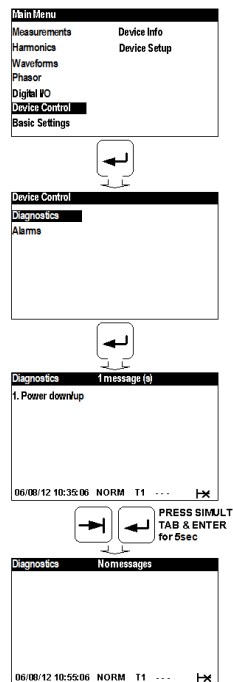

Figure 6-2: Reset Maximum Demands Dialog Box

6.2 Viewing and Clearing Device Diagnostics

Using the Front Display

See [Diagnostics Display](#) in Chapter 3 on how to view and clear device diagnostics from the front display.



Using PAS

Ensure that the **On-line** button on the PAS toolbar is checked, select **Device Control** from the Monitor menu, and then click on the **Device Diagnostics** tab.

See [Device Diagnostic Codes](#) in Appendix G for the list of diagnostic codes and their meaning.

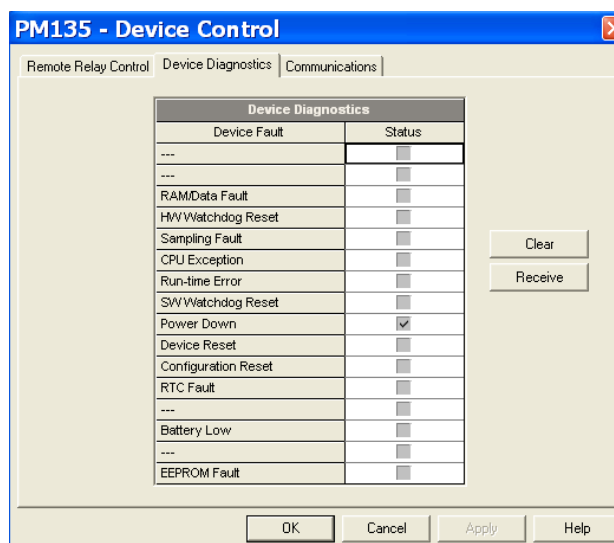

Figure 6-3: Device Control Dialog Box – Device Diagnostics Tab

To clear the device diagnostics events, click on **Clear**.

6.3 Viewing Communication Status and Statistics

Ensure that the **On-line** button on the PAS toolbar is checked, select **Device Control** from the Monitor menu, and then click on the **Communications** tab.

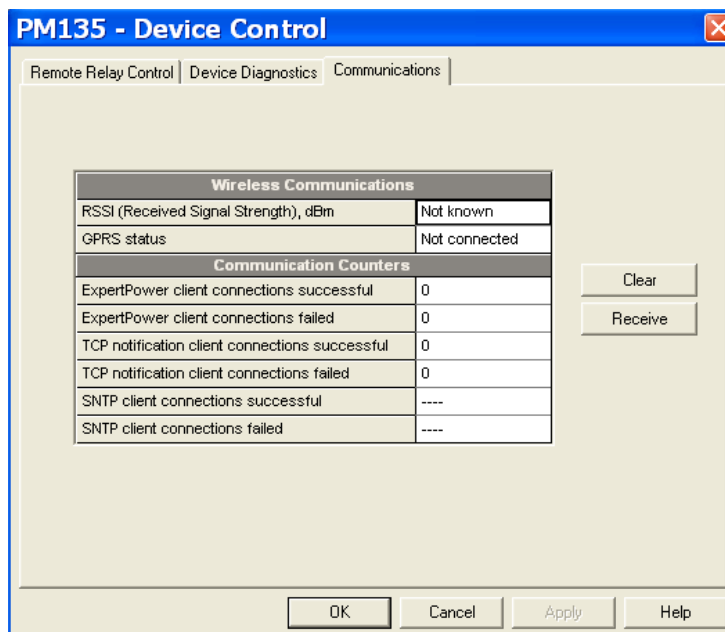

Figure 6-4: Device Control Dialog Box – Communications Tab

This window indicates the present GPRS communication status (see [Setting Up GPRS Network](#) in Chapter 5) and connection statistics of the TCP clients (see [Setting Up eXpertPower Client](#) and [Setting Up TCP Notification Client](#) in Chapter 5).

To clear the communication counters, click on **Clear**.

You can also clear the communications counters via the PAS Reset dialog (see [Resetting Accumulators, Maximum Values and Files](#)).

6.4 Remote Relay Control

You can use PAS to send a remote command to your meter to operate any relay output or release a latched relay, except of the relays linked to an internal pulse source. These relays are blocked for operating from outside of the meter.

To access the relay control dialog, ensure that the **On-line** button on the PAS toolbar is checked, select **Device Control** from the Monitor menu, and then click on the **Remote Relay Control** tab.

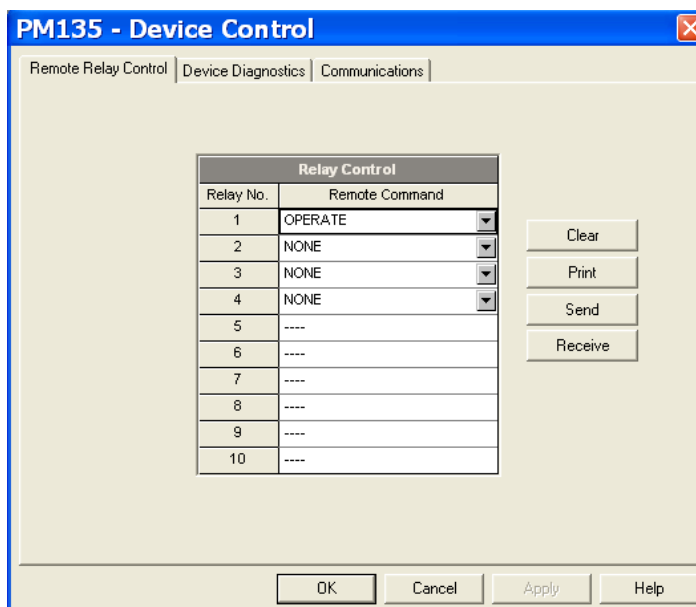

Figure 6-5: Device Control Dialog Box – Remote Relay Control Tab

To send a remote command to a relay:

1. Select a desired command in the **Relay Command** box for a relay:

OPERATE – to operate a relay

RELEASE – to remove your remote command, or to release a latched relay

2. Click **Send**.

6.5 Upgrading Device Firmware

Your meter has upgradeable firmware. If you need to upgrade your device, download a new firmware file to the meter through PAS.

Firmware can be downloaded via the Modbus RTU or Modbus/TCP protocol through any communication port.

To download a new firmware file to your device:

1. Ensure that the communication port you are connected through to the meter operates in Modbus mode.
2. If you are connected to the meter through a serial interface, it is recommended to set the port baud rate to 115,200 bps. See [Setting Up Serial Communication Ports](#) on how to remotely change the protocol and baud rate in your meter.
3. Ensure that the **On-line** button on the PAS toolbar is checked, and then select **Flash Downloader** from the **Monitor menu** and confirm downloading.
4. Point to the firmware upgrade file for your meter, click Open, and then confirm upgrading the meter.

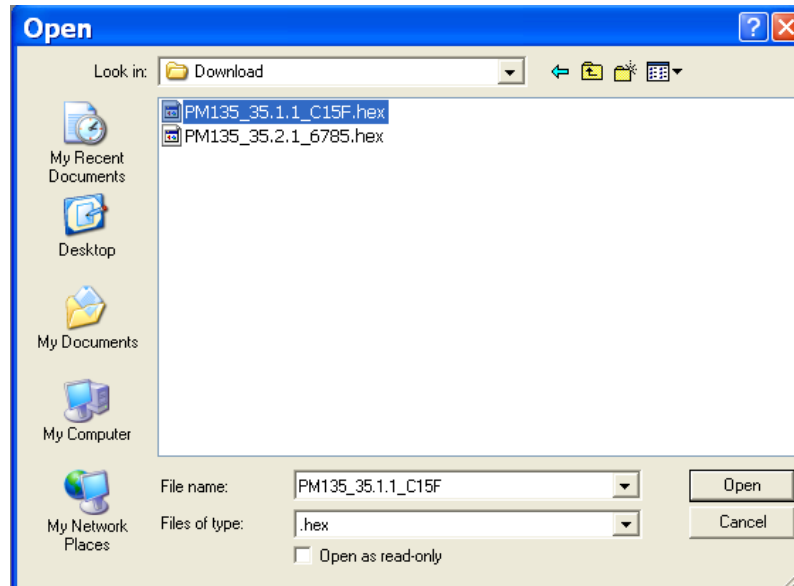

5. You are asked for the password regardless of the password protection setting in your meter. Type the meter password, and click OK. If you did not change the password in the meter, enter the default password 0.

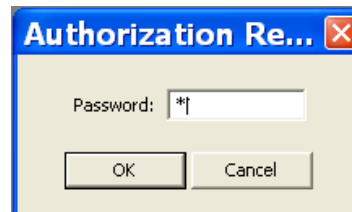

6. Observe the PM135 Display screen with "Flash Loader Running..." notification as below

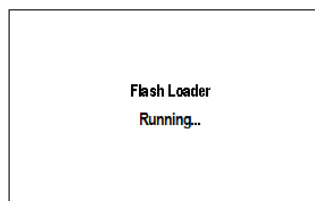

7. Wait until PAS completes upgrading your device. It takes about 3-4 minutes at 115,200 bps to download the file to the meter.

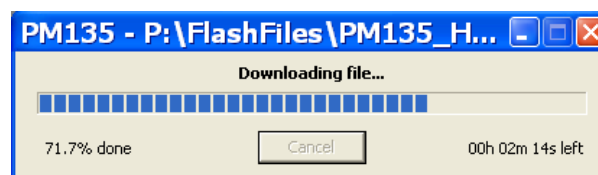

8. After upgrading firmware is completed, the meter restarts, so communications can be temporarily

lost. You may need to wait a short duration until PAS restores a connection with your device.

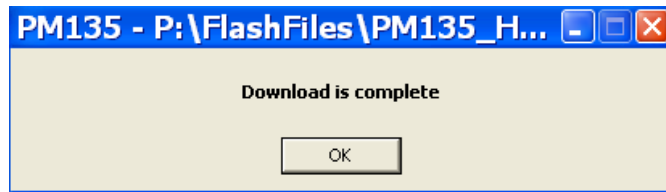

Chapter 7 Monitoring Meters



7.1 Viewing Real-time Data

Real-time data can be continuously retrieved from your devices and updated on the screen at the rate you defined in the Instrument Setup.

To get real-time data from your meter:

9. Ensure that the **On-line** button on the PAS toolbar is checked.
10. Select the device site from the list box on the PAS toolbar.
11. Point to **RT Data Monitor** on the **Monitor** menu, and then select a data set you want to view.

Polling Devices

Click on the "Poll"  or "Continuous poll"  button to poll the meter once or continuously.

Click on the **Stop** button  to stop continuous polling.

The following picture shows a typical data monitor window.

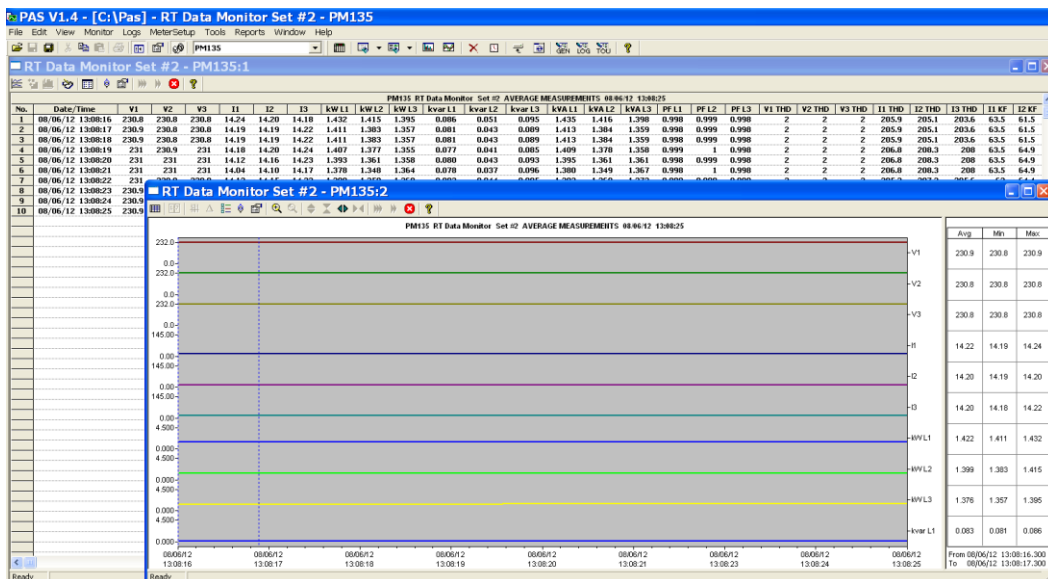



Figure 7-1: RT Data Monitor Window

You can open as many monitor windows as you wish, either for different sites, or for the same site using different data sets. An open data monitor window is linked to the current site and does not change if you select another site in the site list.

You can view acquired data in a tabular form or in a graphical form as a data trend.

Organizing Data Sets

PAS supports 33 programmable data sets with up to 40 data parameters. Set #0 is intended for simple meters, which have a limited number of parameters, and is not recommended for the use with the PM135. To re-organize data sets, select **RT Data Sets** from the **Monitor** menu or click on the button  on the local toolbar.

Some data sets are preset for your convenience and others are empty. You can freely modify data sets.

See Appendix D for a list of data available in your meter.

Polling Options

To change the polling options, click on the Data Monitor window with the right mouse button and select Options.

If you check **Do not stop on errors**, polling is resumed automatically when a communication error occurs, otherwise polling stops until you restart it manually.

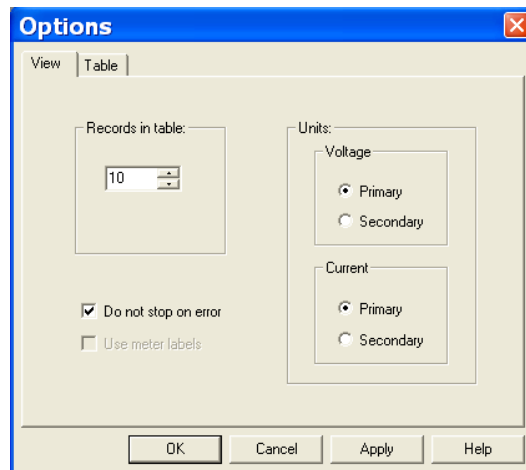

Viewing a Data Table

Changing the Data View

PAS displays data in either a single record or multi-record view. To change the view, click on the **Data Monitor** window with the right mouse button and select either **Wrap** to see a single record, or **UnWrap** to go to the multi-record view.

Adjusting the Number of Rows in a Multi-Record View

Click the window with the right mouse button, select Options, adjust the number of records you want to see in the window, and then click OK. When the number of retrieved records exceeds the number of rows in the window, the window scrolls up so that older records are erased.

See [Working with Tables](#) in Chapter 9 for more information on working with tables.

Viewing Data Trend

To view a data trend, click on the  button on the local toolbar.

To change the time range for your graph, click on the  button on the local toolbar, and then select the desired date and time range.

See [Working with Graphic Windows](#) in Chapter 9 for more information on working with graphs.

Saving Data to a File

To save retrieved data to a file for later analysis, click on the Save button , select an existing database or type the name for a new database, and then click Save.

To avoid confusion, do not store data files into the **Sites** directory where site databases are located.

Printing Data

To check the report, as it will look when printed, select **Print Preview** from the **File** menu.

To print retrieved data, click on the  button on the PAS toolbar, select a printer, and then click **OK**.

Real-time Data Logging

PAS allows you to store data records to a database automatically at the time it updates data on the screen.

To setup the real-time logging options:



1. Open the **Data Monitor** window.
2. Click on the **RT Logging On/Off**  button on the local toolbar, or select **RT Logging Options** from the Monitor menu.
3. Select a database, or type the name for a new database and select a directory where you want to save it.
4. Select the number of tables, and the number of records in each table you want recorded.
5. Adjust the file update rate for automatic recording. It must be a multiple of the sampling rate that you defined in the Instrument Setup dialog.
6. Click **Save**.

When you run real-time data polling, PAS automatically saves retrieved records to a database at the rate you specified.

The **RT Logging On/Off** button  on the toolbar should be checked all the time. You can suspend logging by un-checking the button, and then resume logging by checking it again.

7.2 Viewing Real-time Min/Max Log

To retrieve the real-time Min/Max log data from your meter:



1. Select the device site from the list box on the PAS toolbar.
2. Point to **RT Min/Max Log** on the **Monitor** menu, and then select a data set you want to view.
3. Ensure that the **On-line** button  on the PAS toolbar is checked.
4. Click on the **Poll** button .



PAS supports 9 programmable data sets that you can organize as you wish. To build your data sets, select **MinMax Data Sets** from the **Monitor** menu or click on the  button on the local toolbar.

See [Working with Tables](#) in Chapter 9 for more information on working with tables.

7.3 Viewing Real-time Waveforms

To retrieve real-time waveforms from your meter:

1. Ensure that the **On-line** button  on the PAS toolbar is checked.
2. Select the device site from the list box on the toolbar.
3. Select **RT Waveform Monitor** from the **Monitor** menu or click on the  button on the PAS toolbar.

Use the Poll button  for a single-step poll or the Continuous poll  button for continuous polling.

To stop continuous polling, click on the Stop button .

The meter provides simultaneous capture of six one-cycle voltage and current AC waveforms at a rate of 64 samples per cycle. To give you a more representative picture, PAS extends the waveforms across the window up to eight cycles by repeating the captured waveforms.

To select the channels you want to view, click with the right mouse button on the waveform window, select **Channels...**, check the channels for the phase you want displayed, and then click **OK**.

See [Working with Graphic Windows](#) in Chapter 9 for more information on working with waveforms.

Retrieved waveforms can be displayed in different views as overlapped or non-overlapped waveforms, as RMS cycle-by-cycle plot, or as a harmonic spectrum chart or table.

Viewing a Waveform Graph

When you open a new file, PAS shows you a waveform graph with non-overlapped waveforms as shown in the picture above.

Click on the  button on the local toolbar to see overlapped waveforms.

Click on the  button for non-overlapped waveforms.

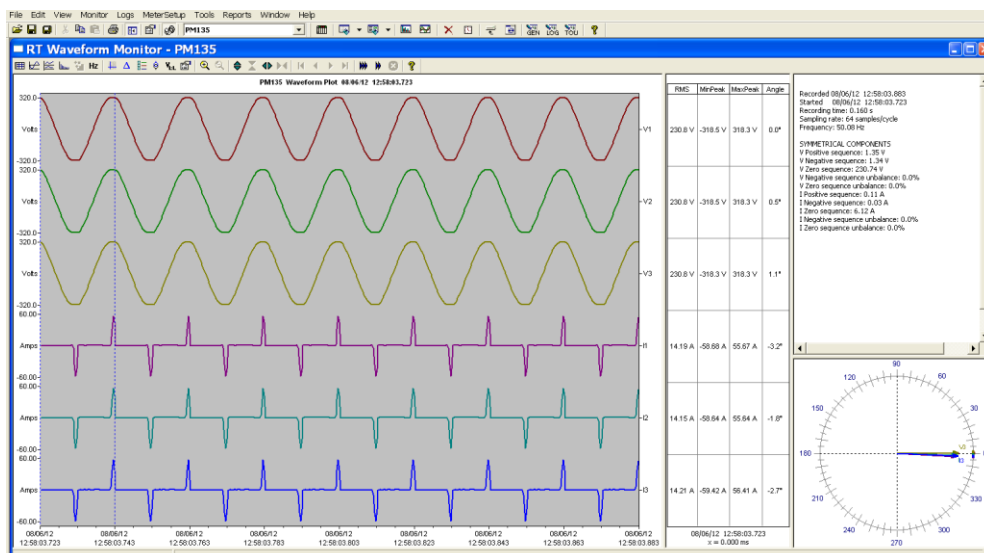



Figure 7-2: RT Waveform Monitor Window

Viewing a Frequency Plot

Click on the **Hz** button to view a cycle-by-cycle frequency plot for the sampled voltage waveforms.

Viewing a Harmonic Spectrum

Click on the  button to view a spectrum chart for the selected waveform channel. PAS provides voltage, current, active power and reactive power spectrum charts. See [Viewing Real-time Harmonic Spectrum](#) for more information on viewing options.

Viewing Phasor Diagrams

The phasor diagrams show you relative magnitudes and angles of the three-phase voltage and current fundamental component. All angles are shown relative to the reference voltage channel.

To change the reference channel, click on the waveform window with the right mouse button, select **Options...**, click on the **Phasor** tab, check the channel you want to make a reference channel, and then click **OK**.

Viewing Symmetrical Components

Waveform views have an additional pane at the right where PAS displays the symmetrical components for voltages and currents, calculated for the point indicated by the left marker line.

To enable or disable the symmetrical components, click on the waveform window with the right mouse button, select **Options...**, check or uncheck the **Symmetrical components** box on the **Channels** tab, and then click **OK**.



Viewing Phase-to-phase Voltages



PAS can transform phase-to-neutral voltage waveforms in configurations with a neutral into phase-to-phase waveforms allowing you to view the waveshape, angle relationships and harmonics of the phase-to-phase voltages.

Click on the  button on the waveform window toolbar. Click the button once again to return to phase-to-neutral waveforms.

7.4 Viewing Real-time Harmonic Spectrum

To retrieve real-time harmonic spectrum from your meter:

4. Ensure that the **On-line** button  on the PAS toolbar is checked.
5. Select the device site from the list box on the toolbar.
6. Select **RT Harmonic Monitor** from the Monitor menu or click on the  button on the PAS toolbar.

Click on the "Poll"  or "Continuous poll"  button to poll the meter once or continuously. Click on the **Stop** button  to stop continuous polling.

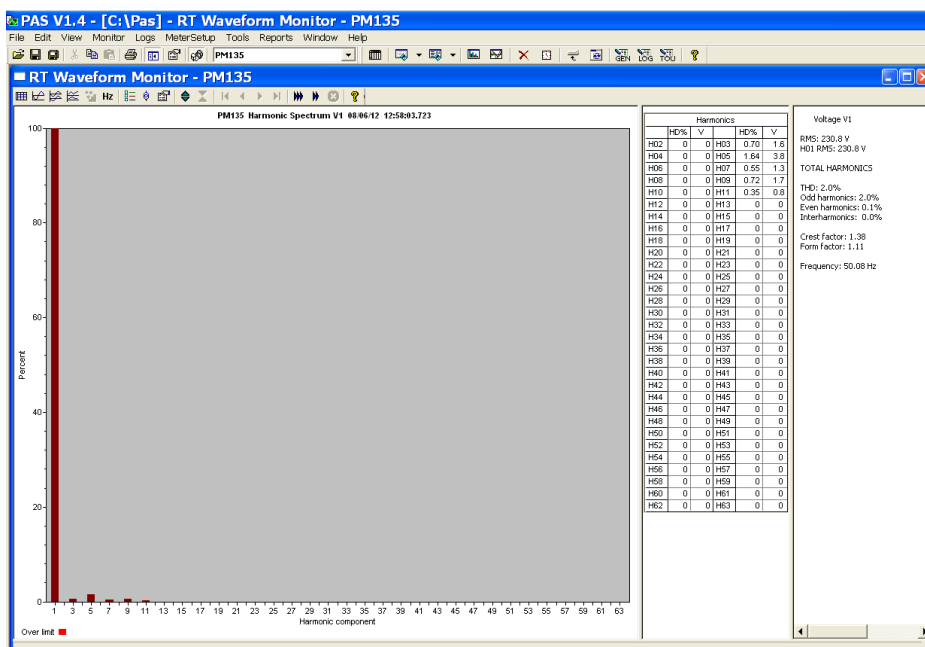



Figure 7-3: RT Harmonic Monitor – Spectrum Chart

PAS retrieves harmonic spectrum for V1-V3 and I1-I3 channels. Harmonics can be displayed as a spectrum chart for a selected channel or in a table. PAS can also synthesize waveforms based on the harmonic spectrum to let you view a shape of the voltage and current waveforms in your network.

Viewing a Spectrum Chart

Click on the  button to view a spectrum chart for the selected channel. To change a channel, click on the window with the right mouse button, select **Channels...**, check the channel you want displayed, and then click **OK**. PAS provides voltage, current, active power and reactive power spectrum charts.

PAS can give you indication on whether harmonic levels in the sampled waveforms exceed compliance limits defined by the power quality standards or local regulations.

To review or change harmonic limits:

1. Click on the spectrum window with the right mouse button and select **Limits...**
2. Select a known harmonics standard, or select **Custom** and specify your own harmonic limits.
3. Check the **Enabled** box to visualize harmonic faults on the spectrum graph and in harmonic tables.

Harmonics that exceed selected compliance levels are colored in red on the graph and in the tables.

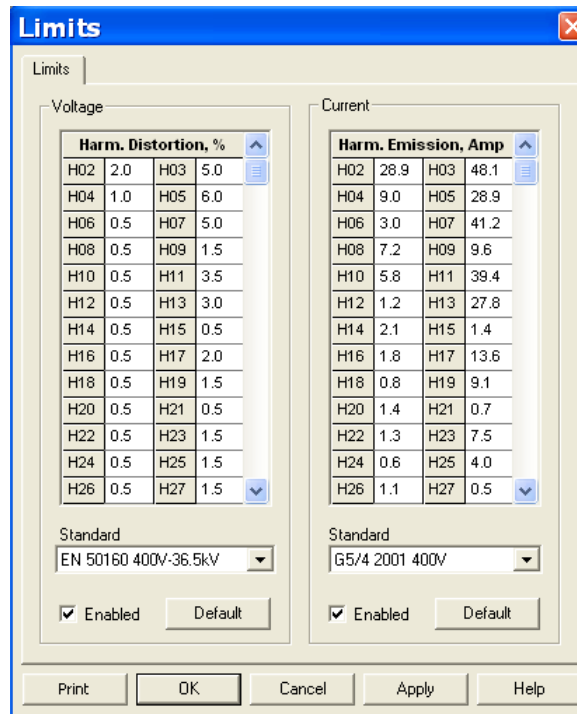

Figure 7-4: Harmonic Limits

Viewing a Spectrum Table

Click on the  button on the local toolbar to display the harmonics spectrum in a tabular view for a selected phase or for all phases together.

The spectrum table shows voltage, current, active power and reactive power harmonic components both in percent of the fundamental and in natural units, and harmonic phase angles.

To change a phase, click on the window with the right mouse button, select **Options...**, check the phase you want displayed, and then click **OK**.

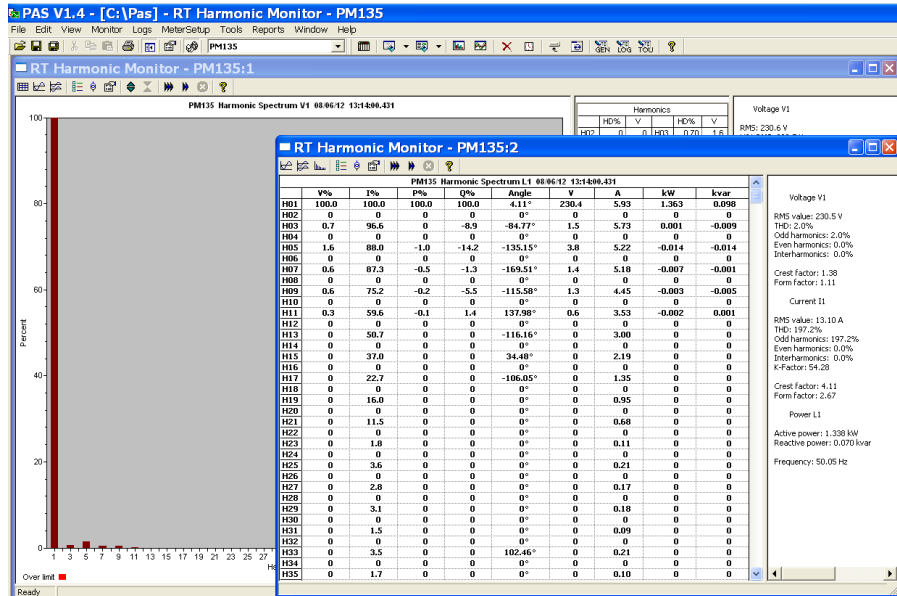

Figure 7-5: RT Harmonic Monitor – Spectrum Table

Viewing Synthesized Waveforms

To view the synthesized waveforms based on the sampled harmonic spectrum, click on the button on the local toolbar to view non-overlapped voltage and current waveforms, or click on the button to view them overlapped.

PAS shows a pair of 4-cycle voltage and current synthesized AC waveforms for a single phase.

To select the channels you want to view, click with the right mouse button on the waveform window, select "Channels...", check the channels for the phase you want displayed, and then click OK.

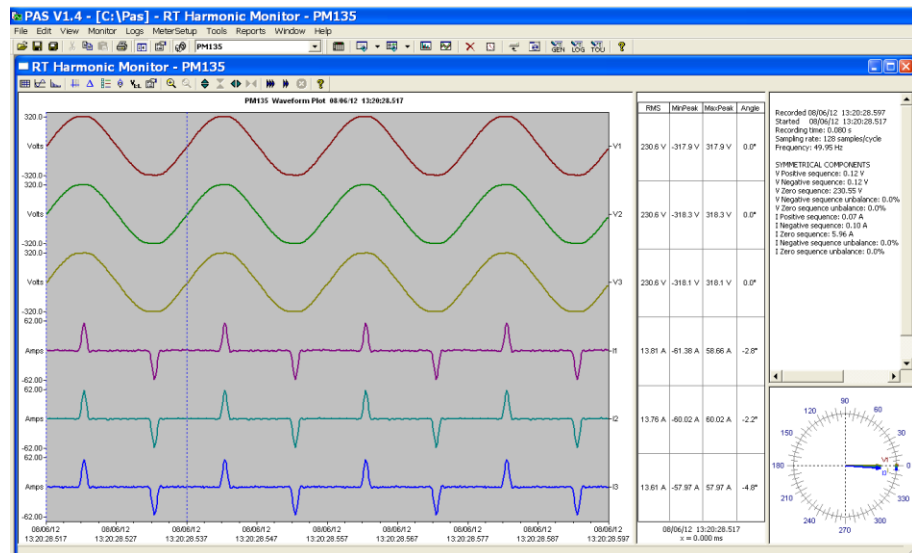

Figure 7-6: RT Harmonic Monitor – Synthesized Waveforms

Chapter 8 Retrieving and Storing Files

PAS allows you to retrieve recorded events and data from your meters and to save them to files on your PC in the Microsoft Access database format.

Historical data can be uploaded on demand any time you need it, or periodically through the Upload Scheduler that retrieves data automatically on a predefined schedule, for example, daily, weekly or monthly.

If you do not change the destination database location, new data is added to the same database so you can store long-term data profiles in one database regardless of the upload schedule you selected.

8.1 Uploading Files on Demand

To retrieve the log files from your meter:

1. Ensure that the On-line button  on the PAS toolbar is checked.
2. Select a device site from the list box on the PAS toolbar.
3. Select **Upload Logs** from the **Logs** menu.

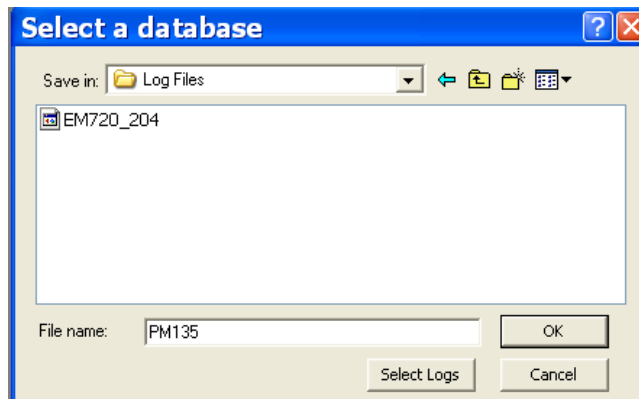

4. Select a database, or type the name for a new database, and select a directory where you want to save it.
5. Click on the **Select Logs** button and check boxes for logs you want to be retrieved from the meter.
6. If you wish to retrieve data starting with a known date, check the **"From"** box and select the start date for retrieving data.
7. If you wish to retrieve data recorded before a known date, check the **"To"** box and select the last date for retrieving data.
8. Click **OK**.

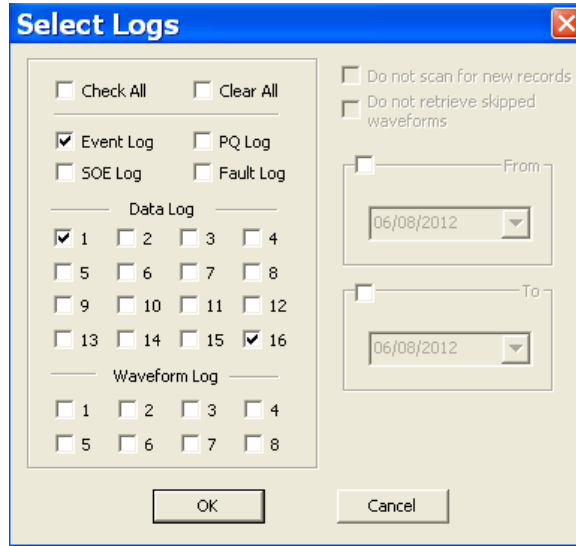

8.2 Using the Upload Scheduler

To setup the Upload Scheduler:

1. Select **Upload Scheduler** from the **Logs** menu.

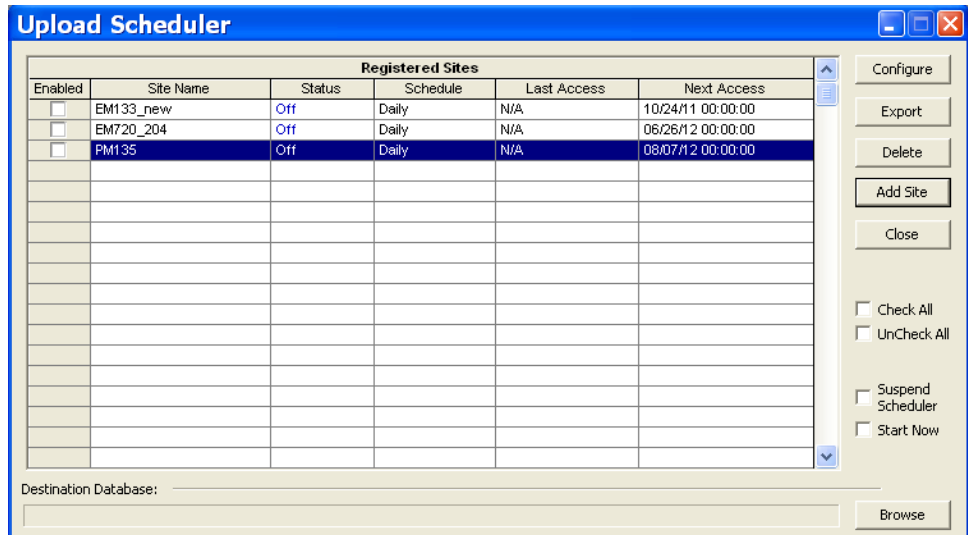
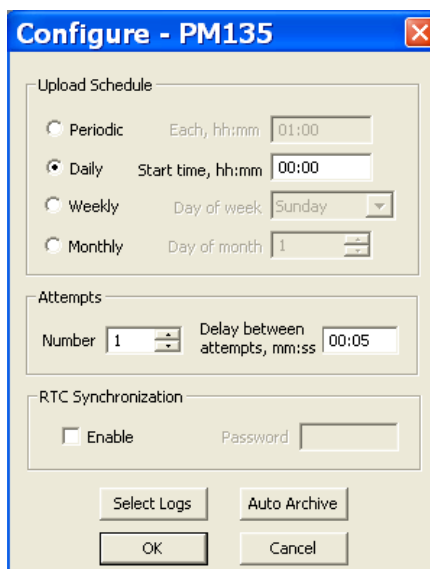



Figure 8-1: Upload Scheduler Setup Dialog Box

2. Click **Add Site**, point to the site database for which you want to organize the schedule, and then click **OK**.
3. Click **Browse** and select a database for storing retrieved data, or type the name for a new database, select a directory where you want to save it, and then click **OK**.
4. Click **Configure** or double click on the site row.



5. Select a daily, weekly or monthly schedule, and adjust the start time. If you wish to upload data periodically in predefined intervals, click on **Periodic** and define the time period in hours and minutes.
6. Select the number of attempts to upload data in the event of temporary communication problems or unavailability of your device, and the delay between attempts in minutes and seconds.
7. If you wish to use the schedule to synchronize the device clock with your PC, check the **RTC Synchronization Enable** box. If your device is password protected by a communications password, type in the password you set in the device to allow PAS to update the clock.
8. Click on the **Select Logs** button, check the boxes for logs you want to upload on a schedule, and then click **OK**.
9. Check the **Enabled** box at left to activate a schedule for the device.
10. Click **Close** to store your schedule.

To keep the Upload Scheduler running, the On-line button  on the PAS toolbar must be checked all the time. If you uncheck it, the scheduler stops operations. This does not cause loss of data, since the scheduler will resume operations when you check this button again.

Suspending the Scheduler

To suspend the Upload Scheduler, check the **Suspend Scheduler** box at right. To activate the Upload Scheduler, leave this box unchecked.

Running the Scheduler on Demand





You can run the scheduler at any time outside the schedule by checking the **Start Now** box at right. This is a one-time action. After uploading is completed, the Upload Scheduler un-checks this box automatically.

Reviewing Upload Problems

When the Upload Scheduler fails to retrieve data from the device, or some data is missing, or another problem occurs, it puts an error message to the log file. To review this file, select **System Log** from the **View** menu.

8.3 Viewing Files On-line

Sometimes, it is useful to review a particular piece of historical data on-line at the time you expect new events to appear in the log. PAS allows you to retrieve historical data from a particular log without storing it to a file. The data appears only in the window on your screen. You can save it manually to the database.

To view the log data on-line, check the **On-line** button  on the PAS toolbar, select the log you want to retrieve in the **Logs** menu, and then click on the **Poll** button . Only new log records are retrieved from the device. If you want to review the entire log from the beginning, click on the **Restore log** button , and then click on the **Poll** button .

NOTE

When reading multi-section profile data, only the first section is available for reading online.

See Chapter 9 [Viewing Files](#) for information on using different log views.

8.4 Exporting Files

Exporting Files in COMTRADE and PQDIF Formats

The COMTRADE and PQDIF file converters allow you to convert saved real-time waveforms into COMTRADE or PQDIF file format, and data log tables – into PQDIF format.

Manual Converting

To manually convert your waveforms or a data log into COMTRADE or PQDIF format:

1. Click on the Export  button on the PAS toolbar.

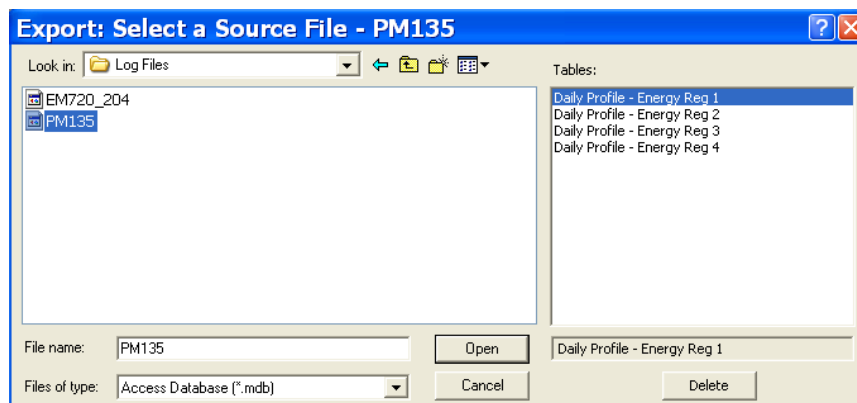

2. Select the database and a data log table you want to export, and then click Open.

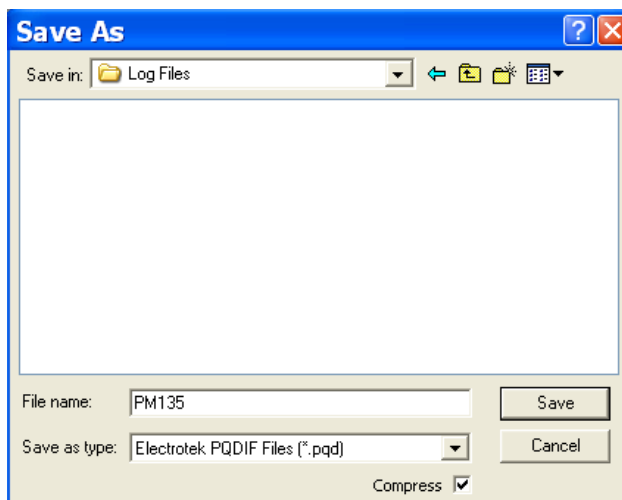

3. Select a folder where you want to store your exported files, type a file name that identifies your files, select a file output format, and then click on the **Save** button.
4. The PQDIF files are commonly recorded in compressed format. If you do not want your files to be compressed, uncheck the **Compress** box before saving the file.

In COMTRADE format, each waveform event is recorded into a separate file.

PQDIF file names are followed by a timestamp of the first event recorded to the file, and may look like follows:

12KVSUB_20040928T133038.pqd.

Automatic Converting

PAS allows you to automatically convert data logs into PQDIF format at the time you upload data from your devices via the Upload Scheduler.

To automatically convert your data log tables into PQDIF format:

1. Open the Upload Scheduler.
2. Highlight a desired device site with the left mouse button, and then click on the **Export** button.
3. Check the **Enabled** box for a data log or a waveform log table you want to automatically convert at the upload time.
4. Highlight the **Record to...** row for the selected table and click on the **Browse** button.
5. Select a folder where you want to store converted files, type in the converted file's name, select a

desired output file format, and then click on **Save**.

6. Repeat the same for all tables you wish to be converted.
7. Click **OK**.

Exporting Files in Excel Format

PAS allows you to convert data tables into the Microsoft Excel workbook format, either manually, or automatically while retrieving data from your meters via the Upload Scheduler.

To store files in Excel format, follow instructions in the previous section and select **Excel Workbook** as the output file format.

The first row of the Excel table lists data names (see Appendix D) and the second row provides data codes, which identify recorded data points (see Modbus communications guide for data codes) that may be useful for automated table processing.

Each table row is provided with the device identifier that you can define in the meter database (see [Creating a New Site for your Meter](#)).

8.5 Archiving Files

Microsoft Access databases tend to grow fast. Databases above 0.5 Gigabytes can drastically slow down file operations.

To avoid enormous growing files, you can either periodically change the target database, or use the Upload Scheduler's file archiver to automatically move older data to archives.

The Upload Scheduler archives files upon a weekly, monthly or yearly schedule. When archiving data, a new database is created to where older data from your present database with the expired archiving date is moved.

An archive file keeps the original database name to which the date of the oldest database record is added, so you can easily identify your archives and work with them as you work with a regular database.

To provide a schedule for archiving files:

1. When defining a schedule for uploading files from your meter, click on **Configure** or double click on the site row.
2. Click **Auto Archive**.

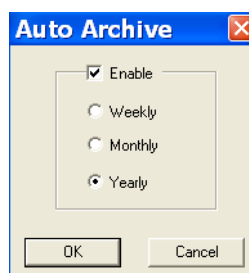

3. Check the **Enable** box and select a periodic schedule for archiving your files for this site.
4. Click **OK**.

To avoid archiving partially updated data, archiving is performed in a day after expiring a scheduled period and not before 2 hours a.m.

Chapter 9 Viewing Files

9.1 Operations with Files

Files you read from the meters are stored in one or in a number of tables in the meter database. Sections of multi-section files like energy load profiles are stored in multiple tables – each file section in a separate database table.

Opening a Database Table

To open a database table:

1. Click on the **Open** button  on the PAS toolbar, or select **Open...** from the File menu.
2. Select **Access Database (*.mdb)** in the **Files of type** box; select a directory where your files are located, and point to the file you wish to open.
3. Select a desired table on the right pane, and then click **Open**, or double click on the table name.

Names of the last 16 files you opened are stored in the **File** menu, so you can select them directly from the menu.

Saving Data to a File

To save data from the open database table to a file:

1. Click on the **Save** button , and select a directory where you want your file to be stored.
2. Select a database or type the name for a new database.
3. Click **Save**.

To avoid confusion, do not store data files into the **Sites** directory where site databases are located.

9.2 Viewing Options

Customizing Views

Changing Date Order

To change the way PAS displays the date:

1. Select **Options** from the **Tools** menu and click on the **Preferences** tab.
2. Select the preferred date order.
3. Click **OK**.

Selecting Timestamp Format

The timestamp is normally recorded and displayed on the screen at a 1-ms resolution. If you have an application that does not support this format, you may instruct PAS to drop milliseconds.

To change the way PAS records and displays the timestamp:

1. Select **Options** from the **Tools** menu and click on the **Preferences** tab.
2. Select the preferred timestamp format.
3. Click **OK**.

Working with Tables

Selecting Font and Grid

To change the table font or a type of the grid lines:

1. Click with right mouse button on the table, select **Options** and click on the **Table** tab.
2. Select the font type and size and how you wish the table grid to be shown.
3. Click **OK**.



Selecting Primary and Secondary Units

Voltages and currents can be displayed in primary or secondary units.

To change units, click on the table with the right mouse button, select **Options**, select the desired units for voltages and currents, and then click **OK**.

Copying a Table

To copy the entire table, or its part, into the Clipboard or into another application such as Microsoft Excel or Word:

1. Click on the data window with the right mouse button and choose **Select All**, or click on the upper-left corner of the table (where the "No." label is commonly displayed).
2. Click with the right mouse button on the window again and choose **Copy**, or click on the **Copy** button  on the PAS toolbar.
3. Run the application to which you want to copy data, position the cursor at the correct place.
4. Click the **Paste** button  on the application's toolbar or select **Paste** from the **Edit** menu.

When copying, table columns are separated by a tab character.

Printing a Table

To check how your document appears on a printed page, select **Print Preview** from the **File** menu.

To print a table to a printer, click on the print button  on the toolbar, select a printer and click **OK**.

Working with Graphic Windows

Selecting Channels

To select the channels you want to view on the screen, click on the graph window with the right mouse button, select **Channels...**, check the channels you want displayed, and then click **OK**.

Checkboxes for channels that are not available in the present view are dimmed.

Selecting Primary and Secondary Units

Voltages and currents can be displayed in primary or secondary units.

To change units, click on the table with the right mouse button, select **Options**, select the desired units for voltages and currents, and then click **OK**.

Selecting the Time Axis

In waveform views, the horizontal axis can be displayed either in absolute time with date and time stamps, or in milliseconds relatively to the beginning of a waveform.

To change the time units, click on the waveform window with the right mouse button, select **Options...**, click on the **Axes** tab, select the desired units, and then click **OK**.

Selecting Line Styles and Colors

Channel waveforms can be displayed using different colors and line styles.

To change the colors or line styles, click on the graph window with the right mouse button, select **Options...**, click on the **Display** tab, adjust colors and styles, and then click **OK**.

Selecting Grid and Frame Colors

Click on the graph window with the right mouse button, select **Options...**, and click on the **Display** tab

To change the color or style of the grid lines, click on the **Grid** line on the left pane, and then select the color and style for the grid. To disable the grid, uncheck the **Grid Visible** box.

To change the window frame color to white, check the **White Frame** box at right.

Using Marker Lines

The waveform and trend windows have two blue dashed marker lines. The left marker indicates the starting position and the right marker indicates the end position for calculating the average and peak values.

The minimum distance between the two markers is exactly one cycle.

To change the marker position, click on the  button, or click on the window with the right mouse button and select **Set Marker**, and then click on the point where you want to put the marker.

You can also drag both markers with the mouse, or use the right and left arrow keys on your keyboard to change the marker position. Click on the graph pane to allow the keyboard to get your input before using the keyboard.

Delta Measurements



To measure the distance between two waveform or trend points, click on the **Delta** button , then click on the first point, and then click on the second point.

The first reference point is still frozen until you uncheck and check the **Delta** button again, while the second point can be placed anywhere within the graph line by clicking on the graph to the left or right from the reference point.

To disable delta measurements, click on the **Delta** button once again.

Using a Zoom

You can use a horizontal and, for waveforms, also a vertical, zoom to change size of your graph.

Use the  buttons on your local toolbar to zoom in and zoom out. One click gives you a 100-percent horizontal or 50-percent vertical zoom. Two buttons  representing magnifying glasses give you a proportional zoom in both directions.

Copying a Graph

To copy a graph, or its part, into the Clipboard or into another application such as Microsoft Excel or Word:

1. Click on the graph window with the right mouse button and choose **Copy All**, or **Copy Waveform**. Some windows may have additional options.
2. Position the cursor at the place where you wish to copy the graph.
3. Click the **Paste** button  on the application's toolbar or select Paste from the **Edit** menu.

Printing a Graph

To check how the graph appears on a printed page, select **Print Preview** from the **File** menu.

To print a graph to a printer, click on the **Print** button  on the PAS toolbar, select a printer and click **OK**.

9.3 Viewing the Event Log

The Event log contains time-tagged events related to configuration changes, resets and device diagnostics.

The Event log is displayed in a tabular view, one event per row. Use the scroll bar to view the entire log contents.

The screenshot shows the 'Event Log - PM135' window with a table of events. The table has columns for No., Date/Time, Event, Cause, Point/Source, Value, Effect, and Target. The events are listed in chronological order, starting from 01/01/00 and ending at 01/18/38.

No.	Date/Time	Event	Cause	Point/Source	Value	Effect	Target
1	01/01/00 00:00:00.000		SELF-CHECK	Data memory		Cleared Event Log	
2	01/01/00 00:00:00.000		SELF-CHECK	Data memory		Cleared Data Log 1	
3	01/01/00 00:00:00.000		SELF-CHECK	Data memory		Cleared Data Log 16	
4	08/06/12 08:49:31.552		COMM	RTC	01/01/70 00:00:00	RTC set	
5	08/06/12 10:31:58.037		EXTERNAL	Power down			
6	08/06/12 10:32:03.000		EXTERNAL	Power up			
7	08/06/12 10:42:32.612		FRONT PANEL	Data memory		Cleared diagnostic	
8	08/06/12 10:54:18.131		EXTERNAL	Power down			
9	08/06/12 10:54:39.000		EXTERNAL	Power up			
10	08/06/12 11:27:05.401		EXTERNAL	Device reset			
11	08/06/12 11:28:58.902		EXTERNAL	Device reset			
12	08/06/12 12:45:14.147		EXTERNAL	Power down			
13	08/06/12 12:45:15.000		SELF-CHECK	RTC	08/06/12 12:45:14	RTC set	
14	08/06/12 12:45:15.000		EXTERNAL	Power up			
15	08/06/12 12:47:49.623		COMM	User options		Setup change	
16	08/06/12 12:48:51.486		COMM	Basic setup		Setup change	
17	08/06/12 12:51:32.999		EXTERNAL	Power down			
18	08/06/12 12:52:41.000		EXTERNAL	Power up			
19	01/18/38 00:00:00.000		EXTERNAL	Power up			
20	01/18/38 00:00:00.000		EXTERNAL	Power up			
21	01/18/38 00:00:00.000		EXTERNAL	Power up			
22	01/18/38 00:00:00.000		EXTERNAL	Power up			
23	01/18/38 00:00:00.000		EXTERNAL	Power up			
24	01/18/38 00:00:00.000		EXTERNAL	Power up			
25	01/18/38 00:00:00.000		EXTERNAL	Power up			
26	01/18/38 00:00:00.000		EXTERNAL	Power up			
27	01/18/38 00:00:00.000		EXTERNAL	Power up			
28	01/18/38 00:00:00.000		EXTERNAL	Power up			
29	01/18/38 00:00:00.000		FRONT PANEL	RTC	01/01/70 00:00:00	RTC set	
30	01/18/38 00:00:00.028		FRONT PANEL	Setpoints setup		Setpoint set	#3
31	01/18/38 00:00:00.053		SELF-CHECK	DNP setups		Reset	
32	01/18/38 00:00:00.061		EXTERNAL	Power down			
33	01/18/38 00:00:00.075		FRONT PANEL	Data memory		Cleared Min/Max	
34	01/18/38 00:00:00.080		EXTERNAL	Power down			
35	01/18/38 00:00:00.092		FRONT PANEL	Display setup		Setup change	
36	01/18/38 00:00:00.094		EXTERNAL	Power down			
37	01/18/38 00:00:00.115		EXTERNAL	Power down			
38	01/18/38 00:00:00.163		FRONT PANEL	Access setup		Setup change	
39	01/18/38 00:00:00.169		SELF-CHECK	IEC 60870-5 setup		Reset	
40	01/18/38 00:00:00.187		FRONT PANEL	Access setup		Setup change	
41	01/18/38 00:00:00.197		SELF-CHECK	IEC 60870-5 setup		Setup change	

Figure 9-1: Event Log Window

See [Working with Tables](#) for more information on viewing options.

Filtering and Sorting Events

You can use filtering to find and work with a subset of events that meet the criteria you specify.

Click on the Filter button , or click on the report window with the right mouse button and select **Filter...** Check the causes of events you want to display, and then click **OK**. PAS temporarily hides rows you do not want displayed.

To change the default sorting order based on the date and time, click on the **Sort** button , or click on the report window with the right mouse button and select **Sort...**, check the desired sort order, and then click **OK**.

9.4 Viewing the Data Log

Data log files can be displayed in a tabular view, one data record per row, or in a graphical view as a data trend graph.

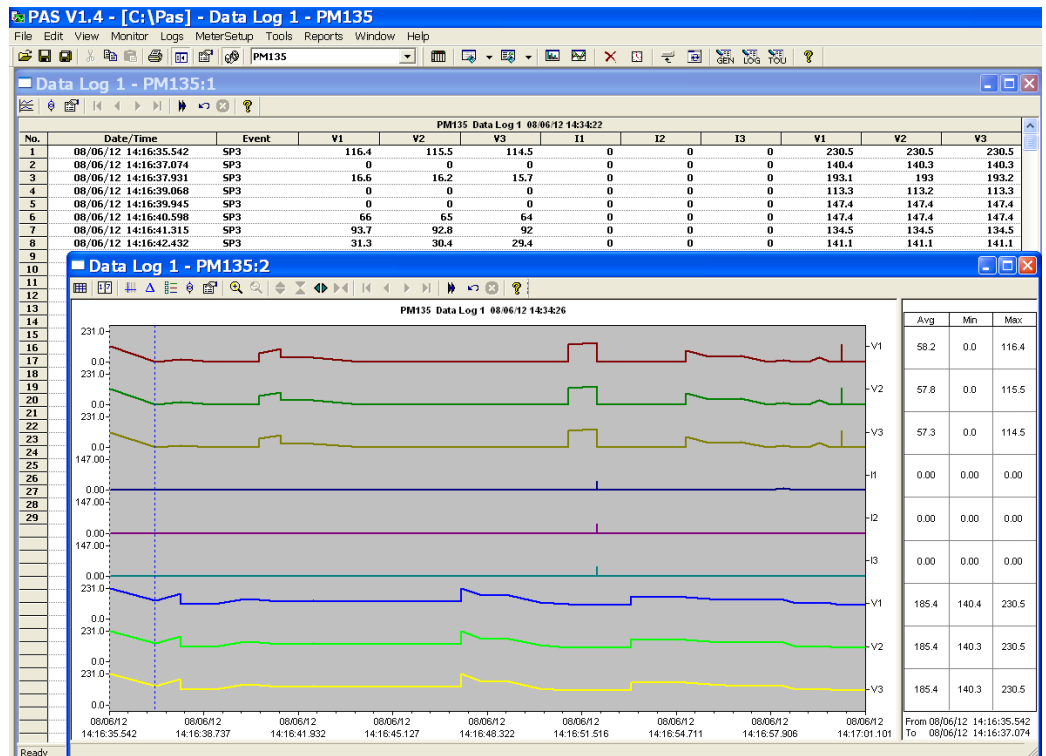



Figure 9-2: Data Log Window

Viewing Data Trend

To view data in a graphical form, click on the **Data Trend**  button on the local toolbar.

To change the time range for your graph, click on the **Time Range** button  on the local toolbar, and then select the desired date and time range.

Appendix A Technical Specifications

A.1 Environmental Conditions

Operating temperature: -30°C to 60°C (-22°F to 140°F)

Storage temperature: -30°C to 85°C (-40°F to 185°F)

Humidity: 0 to 95% non-condensing

A.2 Construction

Dimensions see Figure 2-1

Weight: 0.70 kg (1.54 lb.)

Materials

Case enclosure: plastic PC/ABS blend

Front panel: plastic PC

PCB: FR4 (UL94-V0)

Terminals: PBT (UL94-V0)

Connectors-Plug-in type: Polyamide PA6.6 (UL94-V0)

Packaging case: Carton and Stratocell® (Polyethylene Foam) brackets

Labels: Polyester film (UL94-V0)

A.3 Power Supply

120/230 VAC-DC Option:

Rated input: 85-265VAC 50/60/400 Hz, 88-290VDC, Burden 9VA

Isolation:

Input to ground: 2500 VAC

12 VDC Option:

Rated input: 9.5-18 VDC, Burden 4VA

Isolation: 1500VDC

24/48 VDC Option:

Rated input: 18.5-58 VDC, Burden 4VA

Isolation: 1500VDC

Wire size: up to 12 AWG (up to 3.5 mm²)

A.4 Input Ratings

Voltage Inputs

Operating range: 690VAC line-to-line, 400VAC line-to-neutral

Direct input and input via PT (up to 828VAC line-to-line, up to 480VAC line-to-neutral)

Input impedance: 1000 k Ω

Burden for 400V: < 0.4 VA

Burden for 120V: < 0.04 VA

Over-voltage withstands: 1000 VAC continuous, 2000 VAC for 1 second

Wire size: up to 12 AWG (up to 3.5mm²)

Current Inputs (via CT)

Wire size: 12 AWG (up to 3.5 mm²)

Galvanic isolation: 3500 VAC

5A secondary (standard)

Operating range: continuous 10A RMS

Burden: < 0.2 VA @ In=5A (with 12AWG wire and 1 m long)

Overload withstand:

15A RMS continuous, 300A RMS for 1 second (with 12AWG section wire)

1A secondary (option)

Operating range: continuous 2A RMS

Burden: < 0.02 VA @ In=1A (with 12AWG wire and 1 m long)

Overload withstand:

3A RMS continuous, 80A RMS for 1 second (with 12AWG section wire)

40mA secondary – External Solid or Split core CT (option)

External CT Operating range: continuous 10, 100-1200A RMS

Burden: < 0.02 VA @ nominal current

Sampling Rate measurement

128 samples/cycle

A.5 Optional Relay Outputs

Electromechanical relay - DRY contact, option (4DI/2DO or 12DI/4DO Optional module)

2 or 4 relays rated at 5A/250 VAC; 5A/30 VDC, 1 contact (SPST Form A)

Galvanic isolation:

Between contacts and coil: 3000 VAC 1 min

Between open contacts: 750 VAC

Operate time: 10 ms max.

Release time: 5 ms max.

Update time: 1 cycle

Wire size: 14 AWG (up to 1.5 mm²)

Solid State relay option (4DI/2DO only)

2 relays rated at 0.15A/250 V AC/DC, 1 contact (SPST Form A)

Galvanic isolation: 3750 VAC 1 min

Operate time: 1 ms max.

Release time: 0.25 ms max.

Update time: 1 cycle

Connector type: removable, 4 pins.

Wire size: 14 AWG (up to 1.5 mm²)

A.6 Optional Digital Inputs

4 or 12 Digital Inputs (4DI/2DO or 12DI/4DO Optional module)

Dry Contacts, internally wetted @ 24VDC

Wet contact @ 250VDC (12DI/4DO only)

Sensitivity: Open @ input resistance >100 k Ω , Closed @ Input resistance < 100 Ω

Galvanic isolation: 3750 VAC 1 min

Internal power supply: 24VDC

Scan time: 1 ms

Connector type: removable, 5 pins.

Wire size: 14 AWG (up to 1.5 mm²)

A.7 Optional Analog Outputs

4 Analog Outputs optically isolated (AO Optional module)

Ranges (upon order):

± 1 mA, maximum load 5 k Ω (100% overload)

0-20 mA, maximum load 510 Ω

4-20 mA, maximum load 510 Ω

0-1 mA, maximum load 5 k Ω (100% overload)

Isolation: 2500 VAC 1 min

Power supply: internal

Accuracy: 0.5% FS

Update time: 1 cycle

Connector type: removable, 5 pins.

Wire size: 14 AWG (up to 1.5 mm²)

A.8 Communication Ports

COM1

RS-485 optically isolated port

Isolation: 3000 VAC 1 min

Baud rate: up to 115.2 kbps.

Supported protocols: MODBUS RTU, DNP3, SATEC ASCII, IEC 60870-5-101

Connector type: removable, 3 pins.

Wire size: up to 14 AWG (up to 1.5 mm²).

COM2 (Optional module)

Ethernet Port

Transformer-isolated 10/100BaseT Ethernet port

Supported protocols: MODBUS/TCP (Port 502), DNP3/TCP (Port 20000), IEC 60870-5-104

Number of simultaneous connections: 4 (2 MODBUS/TCP + 2 DNP3/TCP).

Connector type: RJ45 modular.

PROFIBUS DP (IEC 61158)

RS-485 optically isolated PROFIBUS interface.

Connector type: removable, 5 pins.

Baud rate: 9600 bit/s – 12 Mbit/s (auto detection).

32 bytes input, 32 bytes output.

Supported protocols: PROFIBUS

RS-232/422-485 Port

RS-232 or RS-422/485 optically isolated port

Isolation: 3000 VAC 1 min

Baud rate: up to 115.2 kbps.

Supported protocols: MODBUS RTU, DNP3, and SATEC ASCII, IEC 60870-5-101

Connector type: removable, 5 pins for RS-422/485 and DB9 for RS-232.

Wire size: up to 14 AWG (up to 1.5 mm²).

A.9 Real-time Clock

Standard Meter Clock

Non-backed clock

Accuracy: typical error 1 minute per month @ 25°C

Typical clock retention time: 30 seconds

TOU Module Meter Clock

Battery-backed clock

Accuracy: typical error 5 seconds per month @ 25°C (±2.5ppm)

Typical clock retention time: 36 months

A.10 Display

3.5" LCD Monochrome Display, 240 x 128 dots resolution

Tri-color LED load bar graph (40-110%)

COM1 RX/TX activity LED

Diagnostics indication LED

kWh/kvarh Pulse LED (for E and EH models)

Keypad: 5 push buttons

A.11 Standards Compliance

Accuracy:

Complies IEC62053-22, class 0.5S

Meets ANSI C12.20 –1998, class 10 0.5%

Electromagnetic Immunity:

Comply with IEC 61000-6-2:

IEC 61000-4-2 level 3: Electrostatic Discharge

IEC 61000-4-3 level 3: Radiated Electromagnetic RF Fields

IEC 61000-4-4 level 3: Electric Fast Transient

IEC 61000-4-5 level 3: Surge

IEC 61000-4-6 level 3: Conducted Radio Frequency

IEC 61000-4-8: Power Frequency Magnetic Field

Meets ANSI/IEEE C37.90.1: Fast Transient SWC

Electromagnetic Emission:

Comply with IEC 61000-6-4: Radiated/Conducted class A

Comply with IEC CISPR 22: Radiated/Conducted class A

Safety/Construction:

Meets IEC 61010-1: 2006

AC and Impulse Insulation:

Comply with IEC 62052-11:

2500 VAC during 1 minute

6KV/500Ω @ 1.2/50 μs impulse

A.12 Measurement Specifications

Table 21: Measurement Specifications Parameters

Parameter	Full Scale @ Input Range	Accuracy			Range
		% Reading	% FS	Conditions	
Voltage	120V×PT @ 120V 400V×PT @ 690V	0.2	0.02	10% to 120% FS	0 to 1,150,000 V Starting voltage 1.5-5.0% FS (selectable)
Line current	CT	0.2	0.02	For In = 5A 1% to 200% FS For In = 1A 5% to 200% FS	0 to 50,000 A Starting current 0.1% FS
Active power	0.36×PT×CT @ 120V 1.2×PT×CT @ 690V	0.3	0.02	PF ≥ 0.5 ¹	-10,000,000 kW to +10,000,000 kW
Reactive power	0.36×PT×CT @ 120V 1.2×PT×CT @ 690V	0.3	0.04	PF ≤ 0.9 ¹	-10,000,000 kvar to +10,000,000 kvar
Apparent power	0.36×PT×CT @ 120V 1.2×PT×CT @ 690V	0.3	0.02	PF ≥ 0.5 ¹	0 to 10,000,000 kVA
Power factor	1.000		0.2	PF ≥ 0.5, I ≥ 2% FSI	-0.999 to +1.000
Frequency	50 Hz 60 Hz 25 Hz 400 Hz	0.02 0.04		V _{L-N} > 25V	15 Hz to 70 Hz 15 Hz to 70 Hz 15 Hz to 70 Hz 320 Hz to 480 Hz
Total Harmonic Distortion, THD V (I), %V _f (%I _f)	999.9	1.5	0.2	THD ≥ 1%, V ≥ 10% FSV and V _{L-N} > 25V, I ≥ 10% FSI	0 to 999.9
Total Demand Distortion, TDD, %	100		1.5	TDD ≥ 1%, I ≥ 10% FSI, V _{L-N} > 25V	0 to 100
Active energy Import & Export		Class 0.5S under conditions as per IEC 62053-22:2003			0 to 999,999,999 kWh
Reactive energy Import & Export		Class 0.5S under conditions as per IEC 62053-22:2003, PF ≤ 0.9			0 to 999,999,999 kvarh
Apparent energy		Class 0.5S under conditions as per IEC 62053-22:2003			0 to 999,999,999 kVAh

PT - external potential transformer ratio

CT - primary current rating of the external current transformer

FSV - voltage full scale

FSI - current full scale

V_f - fundamental voltage

I_f - fundamental current

NOTES

1. Accuracy is expressed as ± (percentage of reading + percentage of full scale) ± 1 digit. This does not include inaccuracies introduced by the user's potential and current transformers. Accuracy calculated at 1second average.

¹ @ 80% to 120% of voltage FS, 1% to 200% of current FS and frequency 50/60 Hz

2. Specifications assume: voltage and current waveforms with $\text{THD} \leq 5\%$ for kvar, kVA and PF, and reference operating temperature $20^{\circ}\text{C} - 26^{\circ}\text{C}$.
3. Measurement error is typically less than the maximum error indicated.

Appendix B Analog Output Parameters

The following table lists parameters that can be provided on the meter's analog outputs.

Table 22: Analog Output Parameters

Display Code	Designation	Description
none	NONE	None (output disabled)
		1-Cycle Phase Values
rt.U1	V1/12 RT ¹	V1/V12 Voltage
rt.U2	V2/23 RT ¹	V2/V23 Voltage
rt.U3	V3/31 RT ¹	V3/V31 Voltage
rt.U12	V12 RT	V12 Voltage
rt.U23	V23 RT	V23 Voltage
rt.U31	V31 RT	V31 Voltage
rt.C1	I1 RT	I1 Current
rt.C2	I2 RT	I2 Current
rt.C3	I3 RT	I3 Current
		1-Cycle Total Values
rt. P	kW RT	Total kW
rt. q	kvar RT	Total kvar
rt. S	kVA RT	Total kVA
rt. PF	PF RT	Total PF
r.PF.LG	PF LAG RT	Total PF Lag
r.PF.Ld	PF LEAD RT	Total PF Lead
		1-Cycle Auxiliary Values
r.nEU.C	In RT	In Current
rt. Fr	FREQ RT	Frequency
		1-Sec Phase Values
Ar.U1	V1/12 AVR ¹	V1/V12 Voltage
Ar.U2	V2/23 AVR ¹	V2/V23 Voltage
Ar.U3	V3/31 AVR ¹	V3/V31 Voltage
Ar.U12	V12 AVR	V12 Voltage
Ar.U23	V23 AVR	V23 Voltage
Ar.U31	V31 AVR	V31 Voltage
Ar.C1	I1 AVR	I1 Current
Ar.C2	I2 AVR	I2 Current
Ar.C3	I3 AVR	I3 Current
		1-Sec Total Values
Ar. P	kW AVR	Total kW
Ar. q	kvar AVR	Total kvar
Ar. S	kVA AVR	Total kVA
Ar. PF	PF AVR	Total PF
A.PF.LG	PF LAG AVR	Total PF Lag
A.PF.Ld	PF LEAD AVR	Total PF Lead
		1-Sec Auxiliary Values
A.nEU.C	In AVR	In Current
Ar. Fr	FREQ AVR	Frequency
		Demands E, EH
AcD.P.i	kW IMP ACD	Accumulated kW import demand
AcD.P.E	kW EXP ACD	Accumulated kW export demand

Display Code	Designation	Description
Acc.q.i	kvar IMP ACD	Accumulated kvar import demand
Acc.q.E	kvar EXP ACD	Accumulated kvar export demand
Acc.S	kVA ACD	Accumulated kVA demand

¹ In 4LN3, 3LN3 and 3BLN3 wiring modes, the voltages will be line-to-neutral; for any other wiring mode, they will be line-to-line voltages.

Appendix C Setpoint Triggers and Actions

Table 23: Setpoint Triggers

Display Code	Designation	Description
None	NONE	None (condition is not active)
		Status Inputs
DI1 On	STAT INP #1 ON	Status input #1 ON
DI2 On	STAT INP #2 ON	Status input #2 ON
DI3 On	STAT INP #3 ON	Status input #3 ON
DI4 On	STAT INP #4 ON	Status input #4 ON
DI5 On	STAT INP #5 ON	Status input #5 ON
DI6 On	STAT INP #6 ON	Status input #6 ON
DI7 On	STAT INP #7 ON	Status input #7 ON
DI8 On	STAT INP #8 ON	Status input #8 ON
DI9 On	STAT INP #9 ON	Status input #9 ON
DI10 On	STAT INP #10 ON	Status input #10 ON
DI11 On	STAT INP #11 ON	Status input #11 ON
DI12 On	STAT INP #12 ON	Status input #12 ON
DI1 OFF	STAT INP #1 OFF	Status input #1 OFF
DI2 OFF	STAT INP #2 OFF	Status input #2 OFF
DI3 OFF	STAT INP #3 OFF	Status input #3 OFF
DI4 OFF	STAT INP #4 OFF	Status input #4 OFF
DI5 OFF	STAT INP #5 OFF	Status input #5 OFF
DI6 OFF	STAT INP #6 OFF	Status input #6 OFF
DI7 OFF	STAT INP #7 OFF	Status input #7 OFF
DI8 OFF	STAT INP #8 OFF	Status input #8 OFF
DI9 OFF	STAT INP #9 OFF	Status input #9 OFF
DI10 OFF	STAT INP #10 OFF	Status input #10 OFF
DI11 OFF	STAT INP #11 OFF	Status input #11 OFF
DI12 OFF	STAT INP #12 OFF	Status input #12 OFF
		Relays
RO1 ON	RELAY #1 ON	Relay #1 ON
RO2 ON	RELAY #2 ON	Relay #2 ON
RO3 ON	RELAY #3 ON	Relay #3 ON
RO4 ON	RELAY #4 ON	Relay #4 ON
RO1 OFF	RELAY #1 OFF	Relay #1 OFF
RO2 OFF	RELAY #2 OFF	Relay #2 OFF
RO3 OFF	RELAY #3 OFF	Relay #3 OFF
RO4 OFF	RELAY #4 OFF	Relay #4 OFF
		Phase Reversal
Pos Phase Reversal	POS PHASE REVERSAL	Positive phase rotation reversal
Neg Phase Reversal	NEG PHASE REVERSAL	Negative phase rotation reversal
		Low/High 1-Cycle Values on any Phase
High Volt RT	HI VOLT RT ¹	High voltage
Low Volt RT	LO VOLT RT ¹	Low voltage
High Amps RT	HI AMPS RT	High current
Low Amps RT	LO AMPS RT	Low current

Display Code	Designation	Description
High Volt THD RT	HI V THD ²	High voltage THD
High Current THD RT	HI I THD ²	High current THD
High KF RT	HI KF RT	High K-Factor
High Current TDD RT	HI I TDD	High current TDD
		1-Cycle Auxiliary Values
High Freq RT	HI FREQ RT	High frequency
Low Freq RT	LO FREQ RT	Low frequency
High Volt Unb% RT	HI V UNB% RT ¹	High voltage unbalance
High Curr Unb% RT	HI I UNB% RT	High current unbalance
		1-Sec Phase Values
High I1 Avr	HI I1 AVR	High I1 current
High I2 Avr	HI I2 AVR	High I2 current
High I3 Avr	HI I3 AVR	High I3 current
Low I1 Avr	LO I1 AVR	Low I1 current
Low I2 Avr	LO I2 AVR	Low I2 current
Low I3 Avr	LO I3 AVR	Low I3 current
		1-Sec Values on any Phase
High Volt Avr	HI VOLT AVR ¹	High voltage
Low Volt Avr	LO VOLT AVR ¹	Low voltage
High Amps Avr	HI AMPS AVR	High current
Low Amps Avr	LO AMPS AVR	Low current
		1-Sec Total Values
High kW Imp Avr	HI kW IMP AVR	High total kW import
High kW Exp Avr	HI kW EXP AVR	High total kW export
High kvar Imp Avr	HI kvar IMP AVR	High total kvar import
High kvar Exp Avr	HI kvar EXP AVR	High total kvar export
High kVA Avr	HI kVA AVR	High total kVA
Low PF Lag Avr	HI PF LAG AVR	Low total PF Lag
Low PF Lead Avr	HI PF LEAD AVR	Low total PF Lead
		1-Sec Auxiliary Values
High In Avr	HI In AVR	High neutral current
High Freq Avr	HI FREQ RT	High frequency
Low Freq Avr	LO FREQ RT	Low frequency
		Demands
High V1/12 Dmd	HI V1/12 DMD ¹	High V1/V12 Volt demand
High V2/23 Dmd	HI V2/23 DMD ¹	High V2/V23 Volt demand
High V3/31 Dmd	HI V3/31 DMD ¹	High V3/V31 Volt demand
High I1 Dmd	HI I1 DMD	High I1 Ampere demand
High I2 Dmd	HI I2 DMD	High I2 Ampere demand
High I3 Dmd	HI I3 DMD	High I3 Ampere demand
High kW Imp BD	HI kW IMP BD	High block kW import demand
High kVA BD	HI kVA BD	High block kVA demand
High kW Imp SD	HI kW IMP SD	High sliding window kW import demand
High kVA SD	HI kVA SD	High sliding window kVA demand
High kW Imp Acc Dmd	HI kW IMP ACD	High accumulated kW import demand
High kVA Imp Acc Dmd	HI kVA ACD	High accumulated kVA demand
High kW Imp Prd Dmd	HI kW IMP PRD	High predicted kW import demand
High kVA Imp Prd Dmd	HI kVA PRD	High predicted kVA demand

Display Code	Designation	Description
		Time and Date Parameters
Day of Week	DAY OF WEEK	Day of week
Year	YEAR	Year
Month	MONTH	Month
Day of Month	DAY OF MONTH	Day of month
Hours	HOURS	Hours
Minutes	MINUTES	Minutes
Seconds	SECONDS	Seconds
Minute Interval	MINUTE INTERVAL	Minute interval: 1-5, 10, 15, 20, 30, 60 min

¹ In 4LN3, 3LN3 and 3BLN3 wiring modes, the voltages will be line-to-neutral; for any other wiring mode, they will be line-to-line voltages.

Table 24: Setpoint Actions

Display Code	Designation	Description
None	NONE	None (no action)
Relay 1 ON	OPERATE RELAY #1	Operate relay RO1
Relay 2 ON	OPERATE RELAY #2	Operate relay RO2
Relay 3 ON	OPERATE RELAY #3	Operate relay RO3
Relay 4 ON	OPERATE RELAY #4	Operate relay RO4
Relay 1 OFF	RELEASE RELAY #1	Release latched relay RO1
Relay 2 OFF	RELEASE RELAY #2	Release latched relay RO2
Relay 3 OFF	RELEASE RELAY #3	Release latched relay RO3
Relay 4 OFF	RELEASE RELAY #4	Release latched relay RO4
Increment counter 1	INC CNT #1	Increment counter #1
Increment counter 2	INC CNT #2	Increment counter #2
Increment counter 3	INC CNT #3	Increment counter #3
Increment counter 4	INC CNT #4	Increment counter #4
Time counter 1	TIME CNT #1	Count operation time using counter #1
Time counter 2	TIME CNT #2	Count operation time using counter #2
Time counter 3	TIME CNT #3	Count operation time using counter #3
Time counter 4	TIME CNT #4	Count operation time using counter #4
Notification	NOTIFICATION	Send a notification message
Data Log 1	DATA LOG #1	Record data to Data Log #1

Appendix D Parameters for Data Monitoring and Logging

The following table lists parameters measured by the meter that are available for monitoring through communications and for recording to a data log file. The left column shows data abbreviations used in PAS. Parameter groups are highlighted in bold.

Table 25: Data Monitoring and Logging Parameters

Designation	Description
NONE	None (stub, read as zero)
DIGITAL INPUTS	Digital Inputs
DI1:16	Digital Inputs Status DI1:DI12
RELAYS	Relays
RO1:16	Relay Status RO1:RO4
COUNTERS	Pulse Counters
COUNTER 1	Counter #1
COUNTER 2	Counter #2
COUNTER 3	Counter #3
COUNTER 4	Counter #4
RT PHASE	1-Cycle Phase Values
V1	V1/V12 Voltage ¹
V2	V2/V23 Voltage ¹
V3	V3/V31 Voltage ¹
I1	I1 Current
I2	I2 Current
I3	I3 Current
kW L1	kW L1
kW L2	kW L2
kW L3	kW L3
kvar L1	kvar L1
kvar L2	kvar L2
kvar L3	kvar L3
kVA L1	kVA L1
kVA L2	kVA L2
kVA L3	kVA L3
PF L1	Power factor L1
PF L2	Power factor L2
PF L3	Power factor L3
V1 THD	V1/V12 Voltage THD ¹
V2 THD	V2/V23 Voltage THD ¹
V3 THD	V3/V31 Voltage THD ¹
I1 THD	I1 Current THD
I2 THD	I2 Current THD
I3 THD	I3 Current THD
I1 KF	I1 K-Factor
I2 KF	I2 K-Factor
I3 KF	I3 K-Factor
I1 TDD	I1 Current TDD
I2 TDD	I2 Current TDD

Designation	Description
I3 TDD	I3 Current TDD
V12	V12 Voltage
V23	V23 Voltage
V31	V31 Voltage
RT TOTAL	1-Cycle Total Values
kW	Total kW
kvar	Total kvar
kVA	Total kVA
PF	Total PF
PF LAG	Total PF lag
PF LEAD	Total PF lead
kW IMP	Total kW import
kW EXP	Total kW export
kvar IMP	Total kvar import
kvar EXP	Total kvar export
V AVG	3-phase average L-N/L-L voltage
V LL AVG	3-phase average L-L voltage
I AVG	3-phase average current
RT AUX	1-Cycle Auxiliary Values
In	In (neutral) Current
FREQ	Frequency
V UNB%	Voltage unbalance ²
I UNB%	Current unbalance ²
AVR PHASE	1-Second Phase Values
V1	V1/V12 Voltage
V2	V2/V23 Voltage
V3	V3/V31 Voltage
I1	I1 Current
I2	I2 Current
I3	I3 Current
kW L1	kW L1
kW L2	kW L2
kW L3	kW L3
kvar L1	kvar L1
kvar L2	kvar L2
kvar L3	kvar L3
kVA L1	kVA L1
kVA L2	kVA L2
kVA L3	kVA L3
PF L1	Power factor L1
PF L2	Power factor L2
PF L3	Power factor L3
V1 THD	V1/V12 Voltage THD ¹
V2 THD	V2/V23 Voltage THD ¹
V3 THD	V3/V31 Voltage THD ¹
I1 THD	I1 Current THD
I2 THD	I2 Current THD
I3 THD	I3 Current THD
I1 KF	I1 K-Factor
I2 KF	I2 K-Factor

Designation	Description
I3 KF	I3 K-Factor
I1 TDD	I1 Current TDD
I2 TDD	I2 Current TDD
I3 TDD	I3 Current TDD
V12	V12 Voltage
V23	V23 Voltage
V31	V31 Voltage
AVR TOTAL	1-Second Total Values
kW	Total kW
kvar	Total kvar
kVA	Total kVA
PF	Total PF
PF LAG	Total PF lag
PF LEAD	Total PF lead
kW IMP	Total kW import
kW EXP	Total kW export
kvar IMP	Total kvar import
kvar EXP	Total kvar export
V AVG	3-phase average L-N/L-L voltage ¹
V LL AVG	3-phase average L-L voltage
I AVG	3-phase average current
AVR AUX	1-Second Auxiliary Values
In	In (neutral) Current
FREQ	Frequency
V UNB%	Voltage unbalance ²
I UNB%	Current unbalance ²
PHASORS	Phasors
V1 Mag	V1/V12 Voltage magnitude ¹
V2 Mag	V2/V23 Voltage magnitude ¹
V3 Mag	V3/V31 Voltage magnitude ¹
I1 Mag	I1 Current magnitude
I2 Mag	I2 Current magnitude
I3 Mag	I3 Current magnitude
V1 Ang	V1/V12 Voltage angle ¹
V2 Ang	V2/V23 Voltage angle ¹
V3 Ang	V3/V31 Voltage angle ¹
I1 Ang	I1 Current angle
I2 Ang	I2 Current angle
I3 Ang	I3 Current angle
DEMANDS	Present Demands (Power Demands E, EH)
V1 DMD	V1/V12 Volt demand ¹
V2 DMD	V2/V23 Volt demand ¹
V3 DMD	V3/V31 Volt demand ¹
I1 DMD	I1 Ampere demand
I2 DMD	I2 Ampere demand
I3 DMD	I3 Ampere demand
kW IMP BD	kW import block demand
kvar IMP BD	kvar import block demand
kVA BD	kVA block demand
kW IMP SD	kW import sliding window demand

Designation	Description
kvar IMP SD	kvar import sliding window demand
kVA SD	kVA sliding window demand
kW IMP ACD	kW import accumulated demand
kvar IMP ACD	kvar import accumulated demand
kVA ACD	kVA accumulated demand
kW IMP PRD	kW import predicted sliding window demand
kvar IMP PRD	kvar import predicted sliding window demand
kVA PRD	kVA predicted sliding window demand
PF IMP@kVA DMD	PF (import) at Maximum kVA sliding window demand
kW EXP BD	kW export block demand
kvar EXP BD	kvar export block demand
kW EXP SD	kW export sliding window demand
kvar EXP SD	kvar export sliding window demand
kW EXP ACD	kW export accumulated demand
kvar EXP ACD	kvar export accumulated demand
kW EXP PRD	kW export predicted sliding window demand
kvar EXP PRD	kvar export predicted sliding window demand
In DMD	In (neutral) current demand
SUMM ACC DMD	Billing Summary (Total) Accumulated Demands E, EH
REG1 ACD	Register #1 accumulated demand
REG2 ACD	Register #2 accumulated demand
REG3 ACD	Register #3 accumulated demand
REG4 ACD	Register #4 accumulated demand
SUMM BLK DMD	Billing Summary (Total) Block Demands E, EH
REG1 BD	Register #1 block demand
REG2 BD	Register #2 block demand
REG3 BD	Register #3 block demand
REG4 BD	Register #4 block demand
SUMM SW DMD	Billing Summary (Total) Sliding Demands E, EH
REG1 SD	Register #1 sliding demand
REG2 SD	Register #2 sliding demand
REG3 SD	Register #3 sliding demand
REG4 SD	Register #4 sliding demand
ENERGY	Total Energy E, EH
kWh IMPORT	kWh import
kWh EXPORT	kWh export
kvarh IMPORT	kvarh import
kvarh EXPORT	kvarh export
kVAh TOTAL	kVAh total
SUMMARY REGS	Billing Summary (Total) Energy Registers E, EH
SUM REG1	Summary energy register #1
SUM REG2	Summary energy register #2
SUM REG3	Summary energy register #3
SUM REG4	Summary energy register #4
PHASE ENERGY	Phase Energy E, EH
kWh IMP L1	kWh import L1
kWh IMP L2	kWh import L2
kWh IMP L3	kWh import L3
kvarh IMP L1	kvarh import L1
kvarh IMP L2	kvarh import L2
kvarh IMP L3	kvarh import L3

Designation	Description
kVAh L1	kVAh total L1
kVAh L2	kVAh total L2
kVAh L3	kVAh total L3
%HD V1	V1/V12 Harmonic Distortions ^{EH 1}
V1 %HD01	H01 Harmonic distortion
V1 %HD02	H02 Harmonic distortion
...	...
V1 %HD40	H40 Harmonic distortion
%HD V2	V2/V23 Harmonic Distortions ^{EH 1}
V2 %HD01	H01 Harmonic distortion
V2 %HD02	H02 Harmonic distortion
...	...
V2 %HD40	H40 Harmonic distortion
%HD V3	V3/V31 Harmonic Distortions ^{EH 1}
V3 %HD01	H01 Harmonic distortion
V3 %HD02	H02 Harmonic distortion
...	...
V3 %HD40	H40 Harmonic distortion
%HD I1	I1 Harmonic Distortions ^{EH}
I1 %HD01	H01 Harmonic distortion
I1 %HD02	H02 Harmonic distortion
...	...
I1 %HD40	H40 Harmonic distortion
%HD I2	I2 Harmonic Distortions ^{EH}
I2 %HD01	H01 Harmonic distortion
I2 %HD02	H02 Harmonic distortion
...	...
I2 %HD40	H40 Harmonic distortion
%HD I3	I3 Harmonic Distortions ^{EH}
I3 %HD01	H01 Harmonic distortion
I3 %HD02	H02 Harmonic distortion
...	...
I3 %HD40	H40 Harmonic distortion
ANG V1	V1/V12 Harmonic Angles ^{EH 1}
V1 H01 ANG	H01 Harmonic angle
V1 H02 ANG	H02 Harmonic angle
...	...
V1 H40 ANG	H40 Harmonic angle
ANG V2	V2/V23 Harmonic Angles ^{EH 1}
V2 H01 ANG	H01 Harmonic angle
V2 H02 ANG	H02 Harmonic angle
...	...
V2 H40 ANG	H40 Harmonic angle
ANG V3	V3/V31 Harmonic Angles ^{EH 1}
V3 H01 ANG	H01 Harmonic angle
V3 H02 ANG	H02 Harmonic angle
...	...
V3 H40 ANG	H40 Harmonic angle
ANG I1	I1 Harmonic Angles ^{EH}
I1 H01 ANG	H01 Harmonic angle

Designation	Description
I1 H02 ANG	H02 Harmonic angle
...	...
I1 H40 ANG	H40 Harmonic angle
ANG I2	I2 Harmonic Angles ^{EH}
I2 H01 ANG	H01 Harmonic angle
I2 H02 ANG	H02 Harmonic angle
...	...
I2 H40 ANG	H40 Harmonic angle
ANG I3	I3 Harmonic Angles ^{EH}
I3 H01 ANG	H01 Harmonic angle
I3 H02 ANG	H02 Harmonic angle
...	...
I3 H40 ANG	H40 Harmonic angle
H1 PHASE	Fundamental (H01) Phase Values
V1 H01	V1/V12 Voltage ¹
V2 H01	V2/V23 Voltage ¹
V3 H01	V3/V31 Voltage ¹
I1 H01	I1 Current
I2 H01	I2 Current
I3 H01	I3 Current
kW L1 H01	kW L1
kW L2 H01	kW L2
kW L3 H01	kW L3
kvar L1 H01	kvar L1
kvar L2 H01	kvar L2
kvar L3 H01	kvar L3
kVA L1 H01	kVA L1
kVA L2 H01	kVA L2
kVA L3 H01	kVA L3
PF L1 H01	Power factor L1
PF L2 H01	Power factor L2
PF L3 H01	Power factor L3
HRM TOT POW	Fundamental and Harmonic Total Power Values
kW H01	Total fundamental kW
kvar H01	Total fundamental kvar
kVA H01	Total fundamental kVA
PF H01	Total fundamental PF
MIN PHASE	Minimum 1-Cycle Phase Values
V1 MIN	V1/V12 Voltage ¹
V2 MIN	V2/V23 Voltage ¹
V3 MIN	V3/V31 Voltage ¹
I1 MIN	I1 Current
I2 MIN	I2 Current
I3 MIN	I3 Current
MIN TOTAL	Minimum 1-Cycle Total Values
kW MIN	Total kW
kvar MIN	Total kvar
kVA MIN	Total kVA
PF MIN	Total PF

Designation	Description
MIN AUX	Minimum 1-Cycle Auxiliary Values
In MIN	In Current
FREQ MIN	Frequency
MAX PHASE	Maximum 1-Cycle Phase Values
V1 MAX	V1/V12 Voltage ¹
V2 MAX	V2/V23 Voltage ¹
V3 MAX	V3/V31 Voltage ¹
I1 MAX	I1 Current
I2 MAX	I2 Current
I3 MAX	I3 Current
MAX TOTAL	Maximum 1-Cycle Total Values
kW MAX	Total kW
kvar MAX	Total kvar
kVA MAX	Total kVA
PF MAX	Total PF
MAX AUX	Maximum 1-Cycle Auxiliary Values
In MAX	In Current
FREQ MAX	Frequency
MAX DMD	Maximum Demands (Power Demands ^{E, EH})
V1 DMD MAX	V1/V12 Maximum volt demand ¹
V2 DMD MAX	V2/V23 Maximum volt demand ¹
V3 DMD MAX	V3/V31 Maximum volt demand ¹
I1 DMD MAX	I1 Maximum ampere demand
I2 DMD MAX	I2 Maximum ampere demand
I3 DMD MAX	I3 Maximum ampere demand
kW IMP SD MAX	Maximum kW import sliding window demand
kW EXP SD MAX	Maximum kvar import sliding window demand
kvar IMP SD MAX	Maximum kW export sliding window demand
kvar EXP SD MAX	Maximum kvar export sliding window demand
kVA SD MAX	Maximum kVA sliding window demand
In DMD MAX	In (neutral) current maximum demand
MAX SUMMARY DMD	Billing Summary (Total) Maximum Demands ^{E, EH}
REG1 MD	Summary register #1 maximum demand
REG2 MD	Summary register #2 maximum demand
REG3 MD	Summary register #3 maximum demand
REG4 MD	Summary register #4 maximum demand
AO RAW	Raw Analog Outputs (A/D Units)
AO1	Analog output AO1
AO2	Analog output AO2
AO3	Analog output AO3
AO4	Analog output AO4
TOU PRMS	TOU Parameters ^{E, EH}
ACTIVE TARIFF	Active TOU tariff
ACTIVE PROFILE	Active TOU profile
TOU REG1	Billing TOU Energy Register #1 ^{E, EH}
REG1 TRF1	Tariff #1 register
REG1 TRF2	Tariff #2 register
...	...
REG1 TRF8	Tariff #8 register

Designation	Description
TOU REG2	Billing TOU Energy Register #2 E, EH
REG2 TRF1	Tariff #1 register
REG2 TRF2	Tariff #2 register
...	...
REG2 TRF8	Tariff #8 register
TOU REG3	Billing TOU Energy Register #3 E, EH
REG3 TRF1	Tariff #1 register
REG3 TRF2	Tariff #2 register
...	...
REG3 TRF8	Tariff #8 register
TOU REG4	Billing TOU Energy Register #4 E, EH
REG4 TRF1	Tariff #1 register
REG4 TRF2	Tariff #2 register
...	...
REG4 TRF8	Tariff #8 register
TOU MAX DMD REG1	Billing TOU Maximum Demand Register #1 E, EH
REG1 TRF1 MD	Tariff #1 maximum demand
REG1 TRF2 MD	Tariff #2 maximum demand
...	...
REG1 TRF8 MD	Tariff #8 maximum demand
TOU MAX DMD REG2	Billing TOU Maximum Demand Register #2 E, EH
REG2 TRF1 MD	Tariff #1 maximum demand
REG2 TRF2 MD	Tariff #2 maximum demand
...	...
REG2 TRF8 MD	Tariff #8 maximum demand
TOU MAX DMD REG3	Billing TOU Maximum Demand Register #3 E, EH
REG3 TRF1 MD	Tariff #1 maximum demand
REG3 TRF2 MD	Tariff #2 maximum demand
...	...
REG3 TRF8 MD	Tariff #8 maximum demand
TOU MAX DMD REG4	Billing TOU Maximum Demand Register #4 E, EH
REG4 TRF1 MD	Tariff #1 maximum demand
REG4 TRF2 MD	Tariff #2 maximum demand
...	...
REG4 TRF8 MD	Tariff #8 maximum demand

¹ In 4LN3, 3LN3 and 3BLN3 wiring modes, the voltages will be line-to-neutral; for any other wiring mode, they will be line-to-line voltages.

² The value is calculated as a relation of the maximum deviation of phase values from a 3-phase average value to a 3-phase average.

NOTE

Designations of some engineering demands and billing energy and demand registers are shown using a short name notation available in PAS V1.4. By default, PAS uses long names compatible with older versions of PAS. You can select a desired notation from the Tools/Options/Preferences tab.

PAS does not allow to store data in files using different data names. If you have a file uploaded with a previous version of PAS using long data names, either continue using long data names, or store data in a new file.

See table below for a list of parameters with short and long names.

Short Data Name	Long Data Name	Description
kW IMP ACD	kW IMP ACC DMD	Accumulated demand
kW IMP PRD	kW IMP PRD DMD	Predicted sliding window demand
PF IMP@kVA MD	PF IMP@kVA MXDMD	PF (import) at maximum kVA demand
REG1 ACD	SUM REG1 ACC DMD	Billing summary (total) register accumulated demand
REG1 BD	SUM REG1 BLK DMD	Billing summary (total) register block demand
REG1 SD	SUM REG1 SW DMD	Billing summary (total) register sliding demand
REG1	SUM REG1	Billing summary (total) energy register
REG1 MD	SUM REG1 DMD MAX	Billing summary (total) register maximum demand
REG1 TRF1	TOU REG1 TRF1	Billing tariff energy register
REG1 TRF1 MD	DMD1 TRF1 MAX	Billing tariff register maximum demand
TRF1	SEASON TRF1	Generic billing tariff energy register
TRF1 MD	SEASON TRF1	Generic billing tariff register maximum demand

Appendix E Billing/TOU Profile Log File

The following table shows the record structure for the daily billing data profile log file.

The second column shows data abbreviations used in the PAS data log reports. Data log file sections are highlighted in bold.

Table 26: Daily Billing/TOU Profile Data Log (Data Log #16)

Field No.	Designation	Description
Energy Register #1		
1	REG1	Summary (total) energy reading
2	TRF1	Tariff #1 energy reading
3	TRF2	Tariff #2 energy reading
4	TRF3	Tariff #3 energy reading
5	TRF4	Tariff #4 energy reading
6	TRF5	Tariff #5 energy reading
7	TRF6	Tariff #6 energy reading
8	TRF7	Tariff #7 energy reading
9	TRF8	Tariff #8 energy reading
...		
Energy Register #4		
1	REG4	Summary (total) energy reading
2	TRF1	Tariff #1 energy reading
3	TRF2	Tariff #2 energy reading
4	TRF3	Tariff #3 energy reading
5	TRF4	Tariff #4 energy reading
6	TRF5	Tariff #5 energy reading
7	TRF6	Tariff #6 energy reading
8	TRF7	Tariff #7 energy reading
9	TRF8	Tariff #8 energy reading
Daily Maximum Demand Register #1		
1	REG1 MD	Summary (total) max. demand reading
2	TRF1 MD	Tariff #1 max. demand reading
3	TRF2 MD	Tariff #2 max. demand reading
4	TRF3 MD	Tariff #3 max. demand reading
5	TRF4 MD	Tariff #4 max. demand reading
6	TRF5 MD	Tariff #5 max. demand reading
7	TRF6 MD	Tariff #6 max. demand reading
8	TRF7 MD	Tariff #7 max. demand reading
9	TRF8 MD	Tariff #8 max. demand reading
...		
Daily Maximum Demand Register #4		
1	REG4 MD	Summary (total) max. demand reading
2	TRF1 MD	Tariff #1 max. demand reading
3	TRF2 MD	Tariff #2 max. demand reading
4	TRF3 MD	Tariff #3 max. demand reading
5	TRF4 MD	Tariff #4 max. demand reading
6	TRF5 MD	Tariff #5 max. demand reading
7	TRF6 MD	Tariff #6 max. demand reading
8	TRF7 MD	Tariff #7 max. demand reading
9	TRF8 MD	Tariff #8 max. demand reading

The number of parameters in each section is automatically configured depending on the number of actual tariffs you defined in the TOU Daily Profiles.

Appendix F Data Scales

The maximum values for volts, amps and power in the PM135 setup and in communications are limited by the voltage and current scale settings. See [Device Options](#) in Chapter 4 on how to change the voltage and current scales in your meter.

The following table shows the meter data scales.

Table 27: Data Scales Values

Scale	Conditions	Range
Maximum voltage (V max)	All configurations	Voltage scale \times PT Ratio, V ¹
Maximum current (I max)	All configurations	Current scale \times CT Ratio, A ^{2, 3}
Maximum Power ⁴	Wiring 4LN3, 3LN3, 3BLN3	V max \times I max \times 3, W
	Wiring 4LL3, 3LL3, 3BLL3, 3OP2, 3OP3, 3DIR2	V max \times I max \times 2, W
Maximum frequency	25, 50 or 60 Hz	100 Hz
	400Hz	500 Hz

¹ The default voltage scale is 144V. The recommended voltage scale is 120V+20% = 144V for using with external PT's, and 690V+20% = 828V for a direct connection to power line.

² CT Ratio = CT primary current/CT secondary current

³ The default current scale is 2 \times CT secondary (2.0A with 1A secondary and 10.0A with 5A secondary).

⁴ Maximum power is rounded to whole kilowatts. With PT=1.0, it is limited to 9,999,000 W.

Appendix G Device Diagnostic Codes

Table 28: Device Diagnostic Codes

Diagnostic Display	Diagnostic Message	Description	Reason
RAM/DATA fault	RAM/DATA Fault	Memory/Data fault	Hardware failure
HW watchdog reset	HW Watchdog Reset	Hardware watchdog reset	Hardware failure
CPU exception	CPU Exception	CPU exception	Hardware failure
Run-time error	Run-time Error	Run-time software error	Hardware failure
SW watchdog reset	SW Watchdog Reset	Software watchdog timeout	Hardware failure
Power down/Up	Power Down	Power Down/Up	Normal power-up sequence
External restart	Device Reset	Warm restart	External restart via communications or by firmware upgrade
Configuration reset	Configuration Reset	Configuration reset	Corrupted setup data has been replaced with the default configuration
RTC fault	RTC Fault	RTC fault	The clock time has been lost
EEPROM fault	EEPROM Fault	EEPROM fault	Hardware failure

See [Diagnostics Display](#) in Chapter 3 for more information on the PM135 built-in diagnostics.

Index

- A**
- Accuracy**, 149
 - Active energy, 149
 - Active power, 149
 - analog outputs, 15, 34, 81, 88, 89, 151
 - Apparent energy, 149
 - Apparent power, 149
- B**
- billing, 101
 - Broken Delta, 26, 30, 81
- C**
- communication, 66, 72
 - counters, 89
 - CT Primary Current, 80
- D**
- Data recorder, 108
 - daylight saving, 97
 - Delta, 26
 - demand, 18, 81
 - diagnostic, 118
 - digital inputs, 14, 15, 16, 85, 86, 89, 93, 98, 101
 - display, 42, 46, 94
 - DNP3, 113
- E**
- Ethernet, 12, 14, 15, 36, 38, 64, 66, 67, 73, 74, 75, 76, 147
 - Event recorder, 108
 - eXpertPower, 77
- F**
- factory defaults, 107
- G**
- GPRS, 14, 16, 41, 73, 76, 77, 119
- H**
- High Resolution Option, 46
- I**
- inputs**, 18
- L**
- Low Resolution Option, 46
- M**
- Maximum Demand Load Current, 80
 - Modbus, 112
- N**
- notification, 78
- O**
- Open Delta, 26, 28, 29, 81
- P**
- PAS, 64
 - password, 62, 71
 - Phase Energy, 83
 - Power Source, 24
 - Profibus, 12, 14, 15, 36, 39, 73, 147
 - PT Ratio, 80, 167
 - Pulse LED, 61
- R**
- Reactive energy, 149
 - Reactive power, 149
 - relay outputs, 14, 15, 31, 33, 86
 - reset, 116
- S**
- setpoints, 91
 - Starting Voltage, 83
- T**
- test mode, 61, 83
 - Total Demand Distortion, 149
 - Total Harmonic Distortion, 149
 - TOU, 101
 - TOU module, 16, 35
- W**
- Wiring Mode, 6, 27, 28, 29, 30, 80, 81
 - Wye, 26, 27, 28, 29, 81