

RF wireless LED remote controller

Model:SR-2819S with SR-1009Fxx



- Four zones/areas
- Press-button RGB+W controller
- Receivers work with WIFI-RF converter to be controlled by smart phone



Product introduction

SR-2819S RGBW remote controller has 4 different zones. It can get Red/ Green/ Blue/ White color directly. The remote controller can save up to 3 colors or 3 modes into corresponding buttons (S1,S2,S3) for each zone.

You can choose any color through color wheel. you can set the system as RGB 3-channeloutput, or RGBW 4-channel output.

Parameter

Remote

Part No.	Operation Voltage	Operation Frequency	DIMENSIONS ø/h (mm)	Remarks
SR-2819S	3.6VDC	434MHz/868MHz	48x140x16	load 3pcs 7 AAA (1.5V) batteries

Receiver

Part No.	Input Voltage	Current	Output	Remarks
SR-1009FA	12-36VDC	4x5A	4x(60-180)W	Constant voltage
SR-1009EA	12-36VDC	4x8A	4x(96-288)W	Constant voltage
SR-1009FA3	12-36VDC	4x350mA	4x(4.2-12.6)W	Constant current
SR-1009FA7	12-36VDC	4x700mA	4x(8.4-25.2)W	Constant current

Product Size

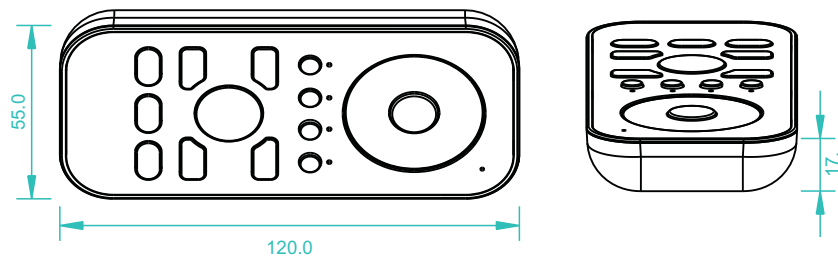

Brief introduction of buttons

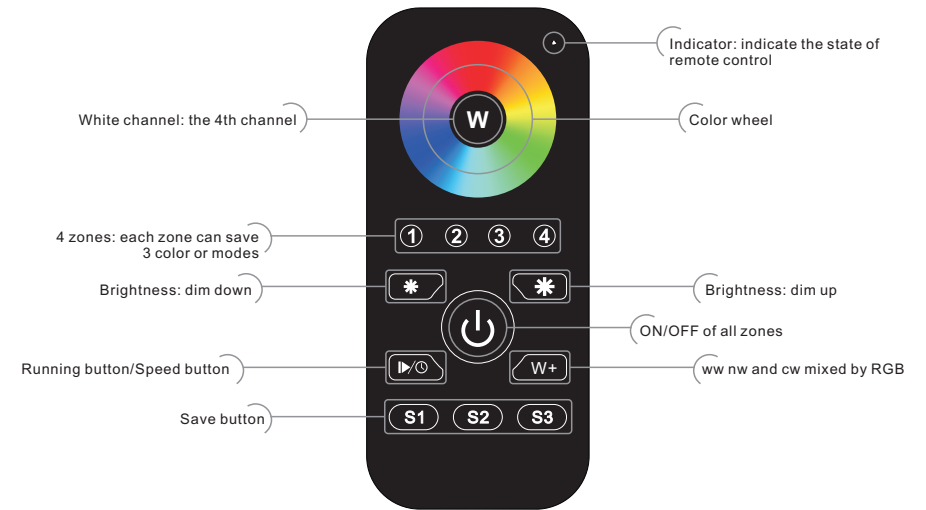

Wiring diagram

1)Receiver Connection Diagram for Single Unit

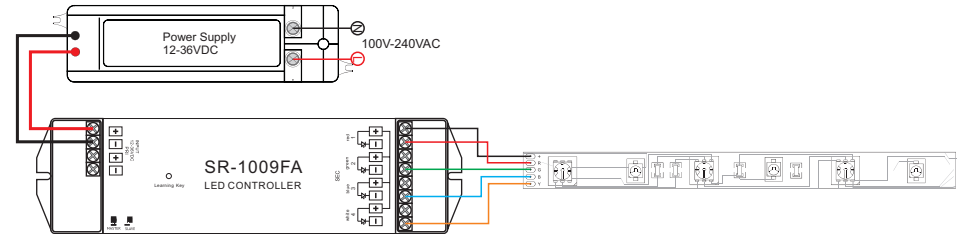

2)Receiver Connection Diagram for Multiple Units

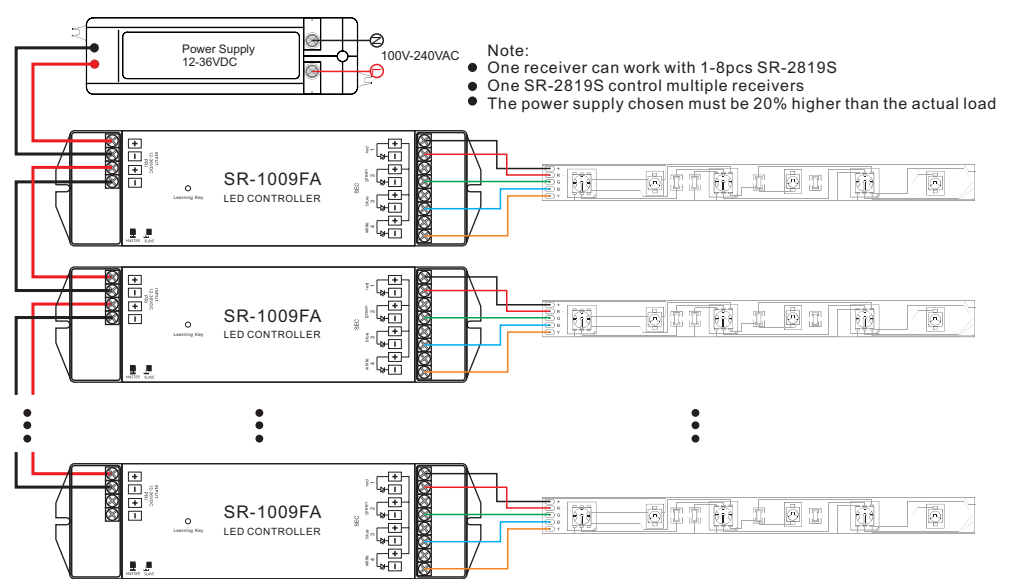

Operation

Learning (matching)

- Do wiring according to connection diagram
- Wake up the remote control by touching ON/OFF button.
- Press learning button on receiver.
- Touch any zone button on remote control.
- Then touch color wheel.
- Connected LED light will blink to confirm zone designation.
- Press at learning button on receiver over 5 seconds until LED light flash, then delete the learned ID.

Note 1: To choose a master from slaves by jumper for each zone.

Short circuit for master.

Open circuit for slave.

Each zone only can set one master controller. After a period of time, the master will do synchronization operation to keep the same color or mode of all slaves in one zone.



Note 2: Each remote control 4 zones (areas) receivers, each area can be learned as many receivers as we can.

Each receiver maximally can be controlled by 8 different remote controllers.

Color wheel



Choose zone number ① ② ③ ④, for example, ① and ③, then touch , choose the color you want, zone 1 and 3 will indicate corresponding color as we touched.

Brightness Up & Down Button

Short/Long press button  to dim down brightness of RGB channels, Short/long press  button to dim up RGB channels.

"W" channel is separated from RGB channels, so we can only long press button to dimming "W" channel.

Running Mould & Speed Button

- Short press , mode will run. Press it once, it runs one mode. Press button again, it stops, then press one more time, it will enter next mode. There are total 10 build-in modes.
- Long press  when mode is running, First long press will speed up the color moving, long press again to speed down the color moving.



W+ Button

a. RGB channel will mix to three different white: warm white, nature white and cold white by short press 

For example: first press---warm white, press again---nature white, third press again---cold white, fourth press---warm white.....

b. Fast click twice  to switch off RGB channel.

Save and recall button

- Save color: select zones from ① ② ③ ④ → select a color from  → long press one save button from S1,S2,S3 for 2-3 second → LED lighting flash twice indicate save successful
 - Save running mold: select zones from ① ② ③ ④ → select a moving mode from  → long press one save button from S1,S2,S3 for 2-3 second → LED lighting flash twice indicate save successful
- c. Recall: select zone button which we want recall from 1-4, then short press save button S1,S2,S3.

Safety & Warnings

- The product shall be installed and serviced by a qualified person.
- IP20. Please avoid the sun and rain. When installed outdoors, please ensure it is mounted in a water proof enclosure.
- Always be sure to mount this unit in an area with proper ventilation to avoid overheating.
- Please check if the output voltage of any LED power supplies used comply with the working voltage of the product.
- Never connect any cables while power is on and always assure correct connections to avoid short circuits before switching on.
- Please ensure that the cable is secured tightly in the connector
- For update information please consult your supplier.

Warranty Agreement

- We provide lifelong technical assistance with this product:
 - 3-year warranty. We print date on every products, for example :1125 means year 2011, week 25. The warranty is for free repair or replacement and covers manufacturing faults only.
 - For faults beyond the 3-year warranty we reserve the right to charge for time and parts.
- Limited Warranty
 - Any defects caused by wrong operation.
 - Any damages caused by unauthorized removal, maintenance, modifying, incorrect connection and replacement of chips.
 - Any damages due to transportation, vibration etc. after purchase.
 - Any damages caused by earthquake, fire, lightning, pollution and abnormal voltage.
 - Any damages caused by negligence, inappropriate storing at high temperatures and humidity or near harmful chemicals.
 - Product has been updated
- Repair or replacement as provided under this warranty is the exclusive remedy to the customer.