



cennik

Aktualny cennik na stronie:



# spis treści

## grzejniki dekoracyjne (Design Program)

ADAMO GOLD	65
ADAMO T CR	64
ALBERO LED	53
ALVO	32
ATOM	13
AUTO	60
AXE	30
BARI	29
BORA	35
BRUNO KOLOR	18
BRUNO T CR	19
CAJA	36
CALLE	37
CARMEL	9
CARRERA N	43
CARRERA P	42
CASA	61
CEDRO	54
CLARO	70
<b>NEW</b> CLEO	39
COMB	20
CORAL, CORAL LED	52
CORNER ALFA	56
CORNER BETA	57
COSTA	38
DIAMANTES	55
EDEN	21
ESCALERA	24
ESFERA	67
FRAGIL	66
FUEGO	8
<b>NEW</b> HEAVEN	46
IMPERADOR	50
KALDERA (UGO K)	28
<b>NEW</b> KEX	47
LEA	40
LENTO	17
LIVIA T CR	63
LOCO, LOCO MINI	4-5
LOFT, LOFT PLUS	22-23
LUCA	41
<b>NEW</b> ORRO	44
PARYS	51
PEDRO T CR	62
PRESTO	16
<b>NEW</b> PUZEL	12
RETRO	68-69
ROD	25
SPIDER	10
SPIDER BIS	11
STONE	58
TENSOR	26
TORGET H	33
TORGET PLUS	34
TREX	14-15
TUBO	6
TUBO K	7
VIBO	27
<b>NEW</b> VINKA	45
WALL	49
<b>NEW</b> WALL NEW	48
WIKING	59
ZORBA	31

## grzejniki chromowane, złote

ADAMO T CR	64
ADAMO GOLD	65
BRUNO T CR	19
CLARO	70
ESFERA	67
FRAGIL	66
LIVIA T CR	63
PEDRO T CR	62
TUBO	6

## grzejniki standardowe

ARIA (A)	80-81
ADAMO (AD/L)	98-99
DINO (A/D)	104
DORA (AD/P)	96-97
ENZO K (AK/EL)	92
<b>NEW</b> FADO	101
GAIA (A/G)	102
MARIO (A/M)	82-83
OSCAR (A/K)	103
PINO K (AK/EP)	88-89
ROSA (AD/R)	100
SARA (A/SP)	94-95
SONIA (A/SL)	93
THOR, THOR V50	90-91
UGO (A/U)	86-87
UMBERTO (AD/UE)	84-85

## grzejniki miedziane

ARIA CU (A)	106
LISA CU (A/L)	110
MARIO CU (A/M)	107
PIETRO CU (A/P)	109
UGO CU (A/U)	108

## grzejniki płytowe

POINT P	72-73
POINT S	74-75
VENEZIA P	76-77
VENEZIA S	78

## grzejniki nierdzewne

ADELE	114
ANILA	112
CALOR PLUS	112
HELIX	112
MELODY	113
MELODY PLUS	113
PAGO	114
SHELF	112
TRIDEN	113
TRIDEN PLUS	113

## grzejniki elektryczne

<b>(suszarki elektryczne)</b>	—
GRZEJNIK ELEKTRYCZNY EL	—
model L i P	116
GRZEJNIK ELEKTRYCZNY	—
EL FADO	117

## akcesoria

GRZAŁKI ELEKTRYCZNE	118-119
ZAWORY GRZEJNIKOWE	120-122
WIESZAKI I RELINGI	123-125
WIESZAKI PRZYKRECANE	—
WP, VP, WL, PP, VL, VPP	125
MOCOWANIA DO GRZEJNIKÓW	126
KOREK I ODPOWIETRZNIKI	126
PRZYKŁADY WZORÓW NA SZKLE	—
DLA GRZEJNIKA COSTA	126
MOC CIEPLNA GRZEJNIKÓW	127
SPOSOBY PODŁĄCZENIA GRZAŁEK	127
WARUNKI ZAKUPU	127

Opis oznaczeń:



dopłata za kolor  
+ 40%



kolor  
w cenie grzejnika



wersja  
elektryczna



wersja  
wodno - elektryczna



wersja  
z przykręcaną suszarką



grzejnik z podłączeniem  
dolnym



grzejnik z podłączeniem  
dolnym 50 mm



grzejnik z podłączeniem  
bocznym



grzejnik z podłączeniem  
krzyżowym

**H** wysokość

**S** szerokość

**L** rozstaw przyłączy

**B** odległość od ściany  
do końca grzejnika

**C** odległość od ściany  
do środka przyłącza

**G** całkowita głębokość  
grzejnika z wieszakami

Alplast nie ponosi odpowiedzialności za możliwe błędy drukarskie w katalogu oraz różnice w kolorystyce grzejników wynikające z formy druku. Dane techniczne zawarte w katalogu mogą ulec zmianie bez wcześniejszego uprzedzenia, jako efekt stałych ulepszeń i modyfikacji naszych produktów. Zawory termostatyczne nie są w komplecie z grzejnikiem. Grzejniki marki Radeco dostępne są w kolorach palety barw RAL oraz palety barw strukturalnych Radeco.

# Design Program

## grzejniki dekoracyjne

(kolor w cenie grzejnika)

**LOCO, LOCO MINI**  
GRZEJNIKI DEKORACYJNE

LOCO 5

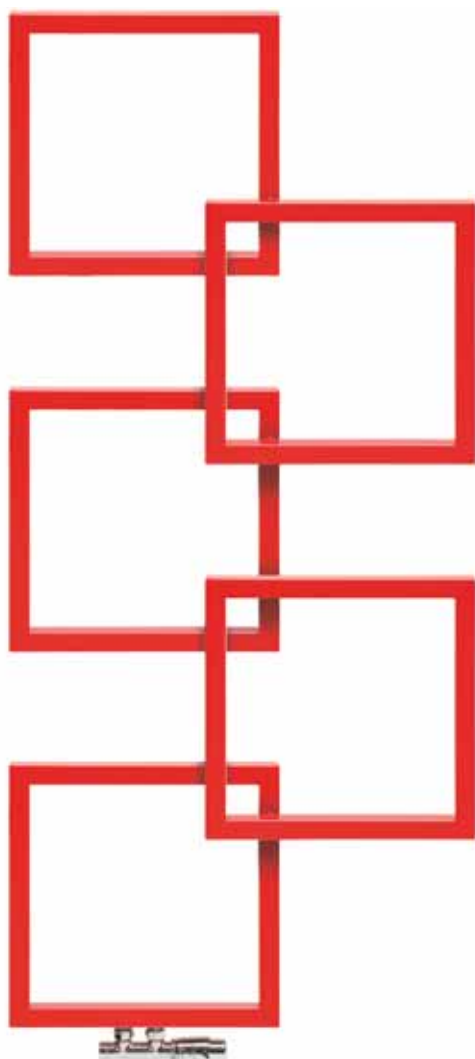

LOCO 5 MINI

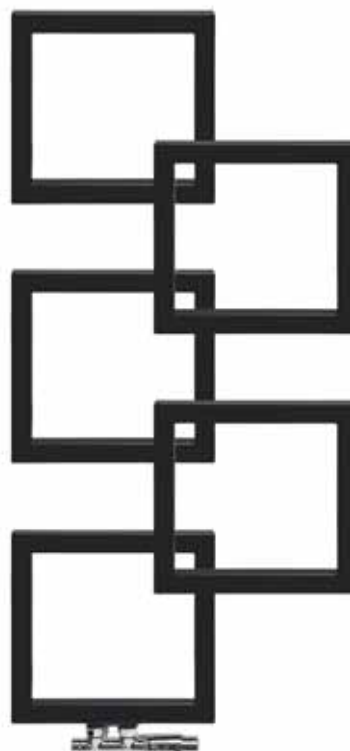

# LOCO, LOCO MINI

## GRZEJNIKI DEKORACYJNE

LOCO 5 / LOCO 5 MINI (prawy)

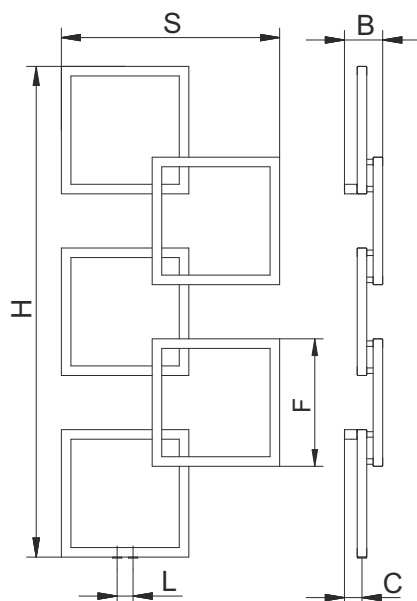

B = 120 ÷ 130 mm  
C = 55 ÷ 65 mm  
F = 400 mm - LOCO  
F = 293 mm - LOCO MINI

LOCO 3  
(prawy)

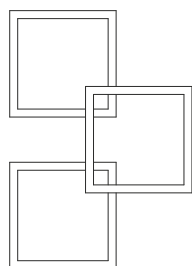

LOCO 4  
(lewy)

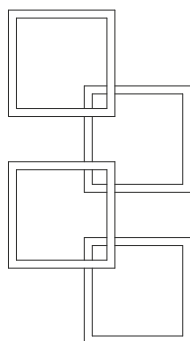

LOCO 3 MINI  
(prawy)

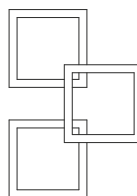

LOCO 4 MINI  
(lewy)

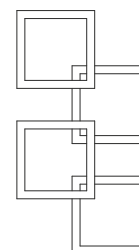

LOCO	H [mm]	S [mm]	L [mm]	Pow. [m <sup>2</sup> ]	Masa [kg]	Poj. [dm <sup>3</sup> ]	Moc grzałki [W]	Moc [W]			Cena [zł netto]
								90/70/20°	75/65/20°	55/45/20°	
LOCO 3	970	685	50	0,48	6,7	3,0	200	380	<b>305</b>	165	1214
LOCO 4	1255	685	50	0,63	8,9	4,0	300	485	<b>390</b>	210	1563
LOCO 5	1540	685	50	0,89	11,1	5,0	300	600	<b>480</b>	260	1918
LOCO 3 MINI	707	500	50	0,34	5,0	2,1	200	270	<b>215</b>	115	1156
LOCO 4 MINI	915	500	50	0,44	6,6	2,9	200	340	<b>270</b>	145	1512
LOCO 5 MINI	1123	500	50	0,55	8,2	3,6	300	418	<b>335</b>	180	1880

Dostępny w wersji prawej oraz lewej.

<p><b>PODŁĄCZENIA standardowe</b></p> <p><i>cena zł netto:</i></p>	<p>dolne v 50</p>		<p><b>opcje</b></p> <p>kolor</p> <p>w cenie grzejnika</p>	<p>podłączenie pod grzałkę</p> <p><b>dopl. 100 zł</b></p>	<p>wodno-elekt.</p>	<p>elektryczne</p>
<p><b>ZAWORY dedykowane</b> (nie są w komplecie z grzejnikiem)</p> <p><i>cena zł netto:</i></p>	<p>twins</p> <p><b>615 zł</b></p>		<p><b>akcesoria</b></p> <p>grzałki elektr.</p> <p>(str. 118-119)</p>	<p>wieszak WLK 30</p> <p><b>dopl. 47 zł</b></p>		<p>dopl.: + koszt grzałki (str. 118-119) + koszt napełnienia wg wzoru: pojemn. x 35 zł katalogowo netto</p>

## TUBO

## GRZEJNIKI DEKORACYJNE

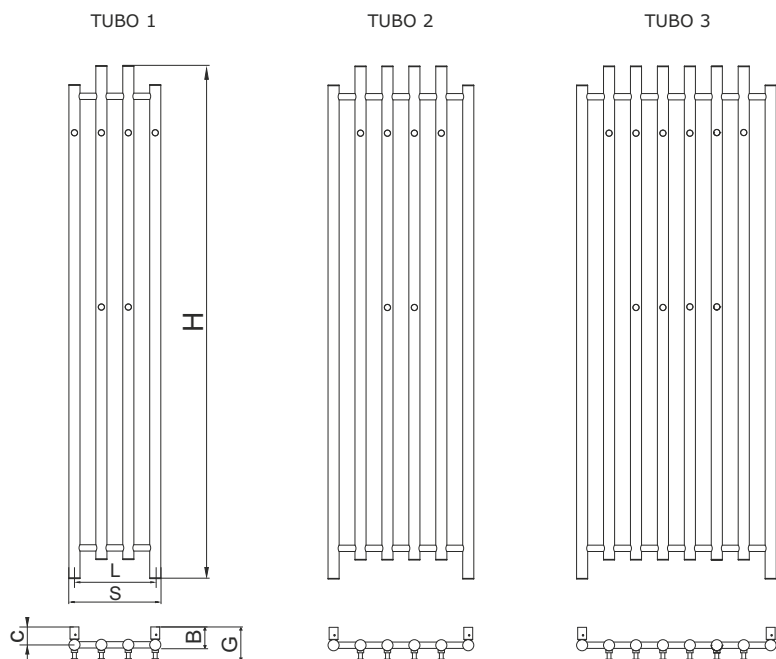

B= 75 ÷ 85 mm  
C= 60 ÷ 70 mm  
G= 100 ÷ 110 mm



TUBO	H [mm]	S [mm]	L [mm]	Pow. [m <sup>2</sup> ]	Masa [kg]	Poj. [dm <sup>3</sup> ]	Moc grzałki [W]	Moc [W]			Cena [zł netto]
								90/70/20°	75/65/20°	55/45/20°	
TUBO 1 CHROM	1620	290	255	0,71	9,2	4,9	300	390	<b>310</b>	155	2099
TUBO 2 CHROM	1620	460	425	1,07	13,5	7,4	300	560	<b>450</b>	225	2999
TUBO 1 KOLOR	1620	290	255	0,71	9,2	4,9	300	490	<b>385</b>	195	1156
TUBO 2 KOLOR	1620	460	425	1,07	13,5	7,4	300	700	<b>560</b>	280	1563
TUBO 3 KOLOR	1620	630	595	1,42	17,9	9,8	600	915	<b>730</b>	365	2035

Wieszak dospawany okrągły WDO w komplecie z grzejnikiem. Dla grzejnika TUBO 1 i 2 - 6szt., Tubo 3 - 10szt.

<b>PODŁĄCZENIA standardowe</b> <i>cena zł netto:</i>	dolne 	krzyżowe 			<b>opcje</b> kolor  <i>w cenie grzejnika</i>	wodno-elekt. 	elektryczne 	wieszak 
<b>ZAWORY dedykowane</b> <small>(nie są w komplecie z grzejnikiem)</small> <i>cena zł netto:</i>	swing  <b>267 zł</b>	vision  <b>450 zł</b>	integra  <b>622 zł</b>	unico  <b>627 zł</b>	<b>akcesoria</b>	dopł.: + koszt grzałki (str. 118-119) + koszt napełnienia wg wzoru: pojemn. x 35 zł katalogowo netto Większa ilość wieszaków WDO (str. 124) w grzejniku Tubo jest dodatkowo płatna.		

# TUBO K

## GRZEJNIKI DEKORACYJNE

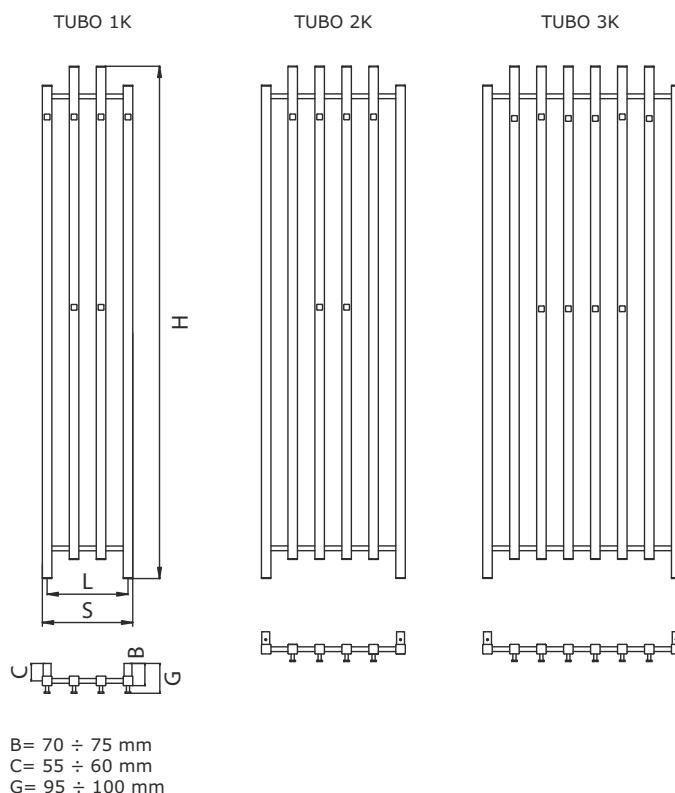

TUBO K	H [mm]	S [mm]	L [mm]	Pow. [m <sup>2</sup> ]	Masa [kg]	Poj. [dm <sup>3</sup> ]	Moc grzałki [W]	Moc [W]			Cena [zł netto]
								90/70/20°	75/65/20°	55/45/20°	
TUBO 1K KOLOR	1620	285	255	0,69	8,9	4,9	300	475	<b>380</b>	205	<b>1156</b>
TUBO 2K KOLOR	1620	455	425	1,04	13,1	7,4	300	680	<b>545</b>	295	<b>1563</b>
TUBO 3K KOLOR	1620	625	595	1,39	17,5	9,8	600	895	<b>715</b>	385	<b>2035</b>

Wieszak dospawany kwadratowy WDK w komplecie z grzejnikiem. Dla grzejnika TUBO 1 i 2 K - 6szt., Tubo 3 K- 10szt.

<b>PODŁĄCZENIA standardowe</b> <i>cena zł netto:</i>	dolne	krzyżowe	opcje		kolor	podłączenie pod grzałkę	wodno-elekt.	elektryczne	wieszak
<b>ZAWORY dedykowane</b> <small>(nie są w komplecie z grzejnikiem)</small> <i>cena zł netto:</i>	swing	vision	integra	unico	akcesoria	grzałki elektr.	dopł.: + koszt grzałki (str. 118-119) + koszt napełnienia wg wzoru: pojemn. x 35 zł katalogowo netto		Większa ilość wieszaków WDK (str. 124) w grzejniku Tubo K jest dodatkowo płatna.

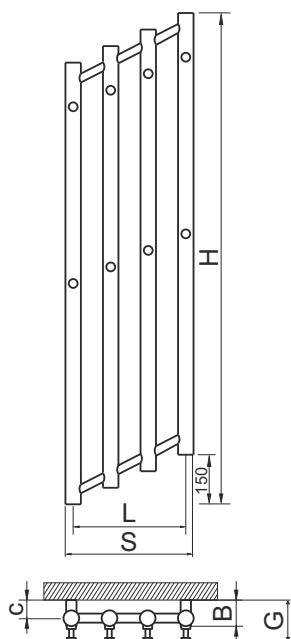
**FUEGO****GRZEJNIKI DEKORACYJNE**

B= 78 ÷ 88 mm  
C= 60 ÷ 70 mm  
G= 104 ÷ 114 mm



FUEGO	H [mm]	S [mm]	L [mm]	Pow. [m <sup>2</sup> ]	Masa [kg]	Poj. [dm <sup>3</sup> ]	Moc grzałki [W]	Moc [W]			Cena [zł netto]
								90/70/20°	75/65/20°	55/45/20°	
FUEGO KOLOR	1650	290	255	0,67	9,0	4,8	300	480	<b>380</b>	205	1396

8 szt. wieszaków dospawanych okrągłych WDO w komplecie z grzejnikiem.

<b>PODŁĄCZENIA standardowe</b> <i>cena zł netto:</i>	dolne	krzyżowe			<b>opcje</b>	kolor	wodno-elekr.	elektryczne	
						 w cenie grzejnika			
<b>ZAWORY dedykowane</b> <small>(nie są w komplecie z grzejnikiem)</small> <i>cena zł netto:</i>	swing	vision	integra	unico	<b>akcesoria</b>	grzałki elektr.			
	 267 zł	 450 zł	 622 zł	 627 zł		 (str. 118-119)	dopl.: + koszt grzałki (str. 118-119) + koszt napełnienia wg wzoru: pojemn. x 35 zł katalogowo netto		

# CARMEL

## GRZEJNIKI DEKORACYJNE

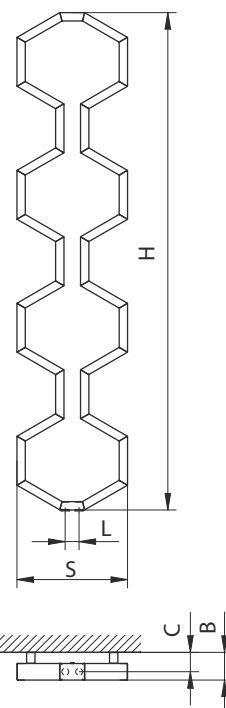

B= 100 ÷ 110 mm  
C= 70 ÷ 80 mm

CARMEL	H	S	L	Pow.	Masa	Poj.	Moc grzałki [W]	Moc [W]			Cena [zł netto]
	[mm]	[mm]	[mm]	[m <sup>2</sup> ]	[kg]	[dm <sup>3</sup> ]		90/70/20°	75/65/20°	55/45/20°	
CARMEL	1800	400	50	0,87	14	8,7	---	630	<b>505</b>	270	2720

<b>PODŁĄCZENIA standardowe</b> <i>cena zł netto:</i>	dolne v 50 		opcje kolor  w cenie grzejnika
	ZAWORY dedykowane (nie są w komplecie z grzejnikiem) <i>cena zł netto:</i>	twins  <b>615 zł</b>	
akcesoria			

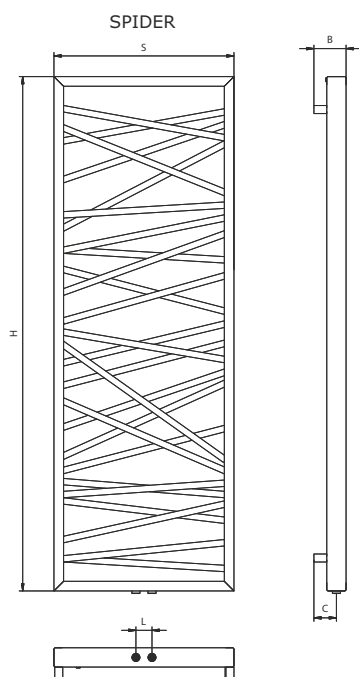
**SPIDER****GRZEJNIKI DEKORACYJNE**

B= 100 ÷ 105 mm  
C= 70 ÷ 75 mm



SPIDER	H [mm]	S [mm]	L [mm]	Pow. [m <sup>2</sup> ]	Masa [kg]	Poj. [dm <sup>3</sup> ]	Moc grzałki [W]	Moc [W]			Cena [zł netto]
								90/70/20°	75/65/20°	55/45/20°	
SPIDER 1	1600	530	50	1,53	19,0	10,4	800	1025	<b>820</b>	445	<b>3850</b>
SPIDER 2	1200	530	50	1,22	14,5	8,7	600	820	<b>655</b>	350	<b>3265</b>

<b>PODŁĄCZENIA standardowe</b> <i>cena zł netto:</i>	dolne v 50 	<b>opcje</b>	kolor  w cenie grzejnika	boczne  <b>dopl. 100 zł</b>	podłączenie pod grzałkę  <b>dopl. 100 zł</b>	wodno-elekt. 	elektryczne 
	<b>ZAWORY dedykowane</b> <small>(nie są w komplecie z grzejnikiem)</small> <i>cena zł netto:</i>		twins  <b>615 zł</b>	<b>akcesoria</b>	grzałki elektr.  (str. 118-119)	dopl.: + koszt grzałki (str. 118-119) + koszt napełnienia wg wzoru: pojemn. x 35 zł katalogowo netto	

# SPIDER BIS

## GRZEJNIKI DEKORACYJNE

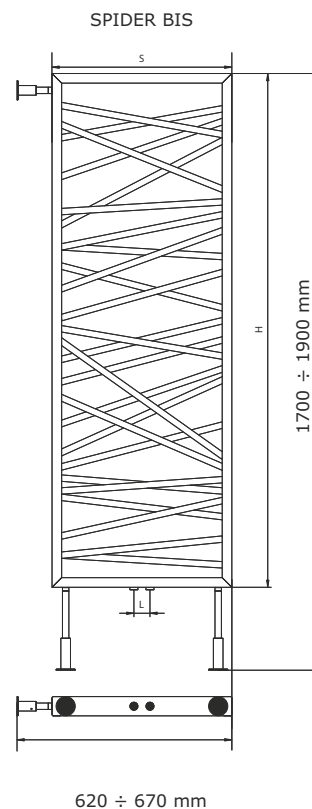

SPIDER BIS	H [mm]	S [mm]	L [mm]	Pow. [m <sup>2</sup> ]	Masa [kg]	Poj. [dm <sup>3</sup> ]	Moc grzałki [W]	Moc [W]			Cena [zł netto]
								90/70/20°	75/65/20°	55/45/20°	
SPIDER BIS 1	1600	530	50	1,53	19,0	10,4	800	1025	<b>820</b>	445	<b>4091</b>
SPIDER BIS 2	1200	530	50	1,22	14,5	8,7	600	820	<b>655</b>	350	<b>3507</b>

<b>PODŁĄCZENIA standardowe</b> <i>cena zł netto:</i>	dolne v 50 		<b>opcje</b>	kolor  w cenie grzejnika	podłączenie pod grzałkę <b>dopl. 100 zł</b>	wodno-elekt. 	elektryczne 
<b>ZAWORY dedykowane</b> (nie są w komplecie z grzejnikiem) <i>cena zł netto:</i>	twins  <b>615 zł</b>		<b>akcesoria</b>	grzałki elektr.  (str. 118-119)			dopl.: + koszt grzałki (str. 118-119) + koszt napełnienia wg wzoru: pojemn. x 35 zł katalogowo netto



## PUZEL

## GRZEJNIKI DEKORACYJNE

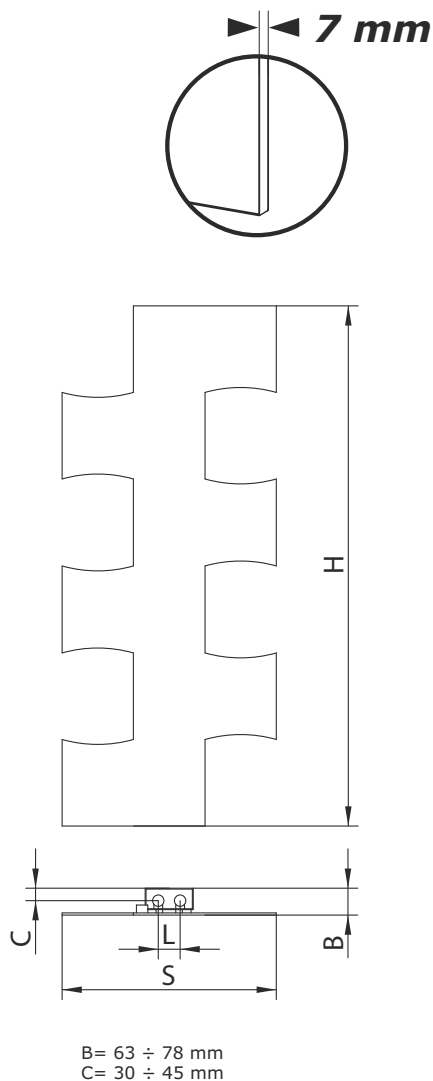

PUZEL	H [mm]	S [mm]	L [mm]	Pow. [m <sup>2</sup> ]	Masa [kg]	Poj. [dm <sup>3</sup> ]	Moc grzałki [W]	Moc [W]			Cena [zł netto]
								90/70/20°	75/65/20°	55/45/20°	
PUZEL	1190	490	50	0,86	10	1,0	---	536	<b>429</b>	231	2470

<b>PODŁĄCZENIA standardowe</b> <i>cena zł netto:</i>	dolne v 50 		opcje kolor  w cenie grzejnika
<b>ZAWORY dedykowane</b> <small>(nie są w komplecie z grzejnikiem)</small> <i>cena zł netto:</i>	twins  <b>615 zł</b>		akcesoria

# ATOM

## GRZEJNIKI DEKORACYJNE

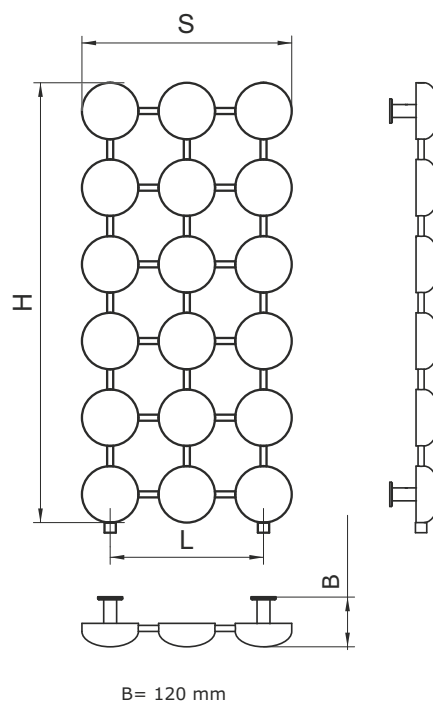
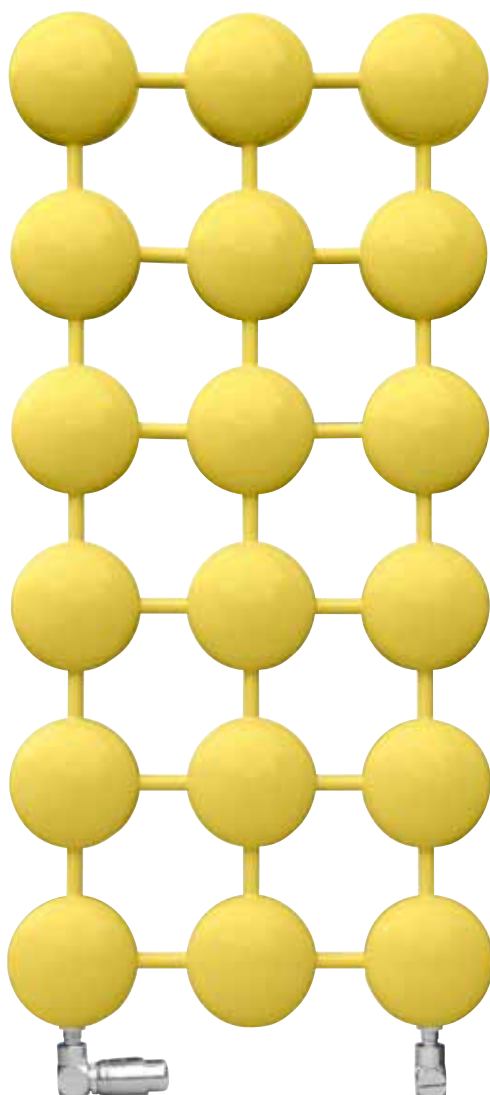

ATOM	H [mm]	S [mm]	L [mm]	Pow. [m <sup>2</sup> ]	Masa [kg]	Poj. [dm <sup>3</sup> ]	Moc grzałki [W]	Moc [W]			Cena [zł netto]
								90/70/20°	75/65/20°	55/45/20°	
ATOM	1100	520	380	0,93	26,5	11,2	---	590	<b>470</b>	250	<b>3129</b>

<b>PODŁĄCZENIA standardowe</b> <i>cena zł netto:</i>	dolne 		opcje kolor  w cenie grzejnika	boczne  dopl. 100 zł
	swing 	vision  450 zł		
<b>ZAWORY dedykowane</b> (nie są w komplecie z grzejnikiem) <i>cena zł netto:</i>	 267 zł		akcesoria	

**TREX****GRZEJNIKI DEKORACYJNE**





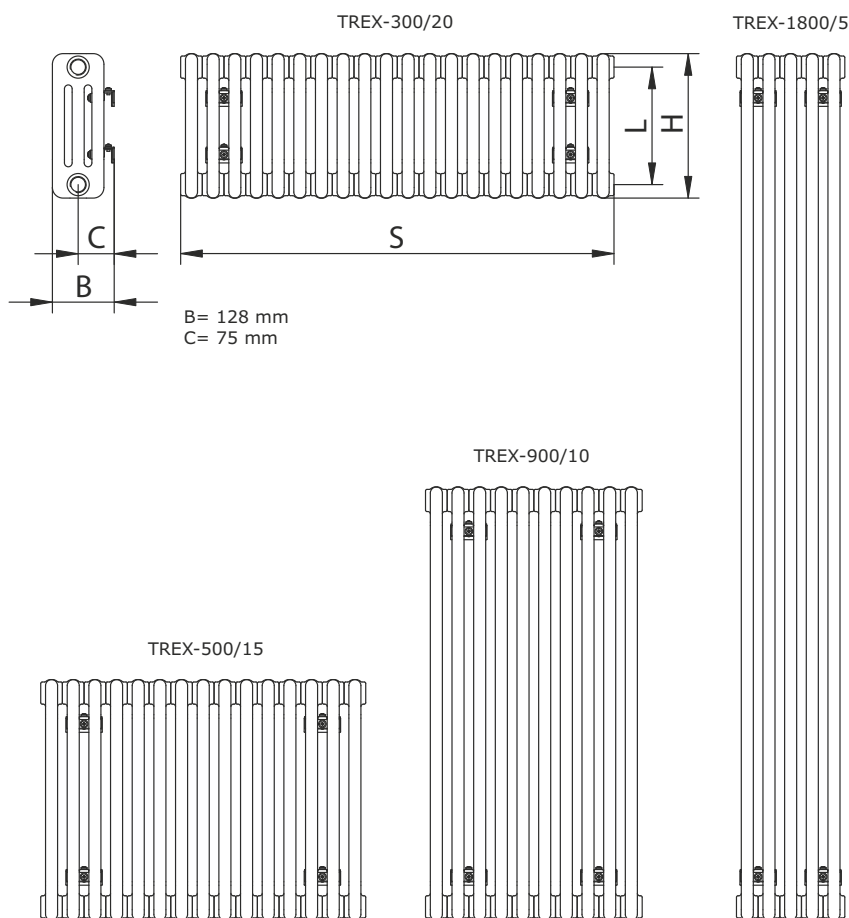



# TREX

## GRZEJNIKI DEKORACYJNE



TREX	H [mm]	S [mm]	L [mm]	Pow. [m <sup>2</sup> ]	Masa [kg]	Poj. [dm <sup>3</sup> ]	Moc grzałki [W]	Moc [W]			Cena [zł netto]
								90/70/20°	75/65/20°	55/45/20°	
TREX-300/5	300	230	244	0,35	3,7	2,7	---	219	<b>174</b>	91	<b>508</b>
TREX-300/10	300	460	244	0,70	7,5	5,4	300	437	<b>347</b>	181	<b>1016</b>
TREX-300/15	300	690	244	1,05	11,2	8,1	300	656	<b>521</b>	271	<b>1523</b>
TREX-300/20	300	920	244	1,40	15,1	10,8	600	874	<b>694</b>	362	<b>2031</b>
TREX-500/5	500	230	444	0,60	5,9	3,9	---	348	<b>276</b>	144	<b>512</b>
TREX-500/10	500	460	444	1,20	12,0	7,9	300	696	<b>552</b>	288	<b>1024</b>
TREX-500/15	500	690	444	1,80	17,5	11,9	600	1043	<b>828</b>	432	<b>1537</b>
TREX-500/20	500	920	444	2,40	23,2	15,8	900	1391	<b>1104</b>	576	<b>2049</b>
TREX-900/5	900	230	844	1,05	10,2	6,35	---	596	<b>473</b>	247	<b>627</b>
TREX-900/10	900	460	844	2,10	20,2	12,7	900	1192	<b>946</b>	494	<b>1258</b>
TREX-900/15	900	690	844	3,15	30,2	19,1	1200	1788	<b>1419</b>	740	<b>1882</b>
TREX-900/20	900	920	844	4,20	40,3	25,4	1200	2384	<b>1892</b>	986	<b>2494</b>
TREX-1800/5	1800	230	1744	2,05	19,7	11,8	---	1135	<b>901</b>	470	<b>1418</b>
TREX-1800/10	1800	460	1744	4,10	39,2	23,5	1200	2271	<b>1802</b>	940	<b>2788</b>
TREX-1800/15	1800	690	1744	6,15	58,8	35,3	1200	3406	<b>2703</b>	1410	<b>4148</b>
TREX-1800/20	1800	920	1744	8,20	78,3	47,0	1200	4541	<b>3604</b>	1880	<b>5528</b>

Nogi do grzejnika TREX nie są w komplecie z grzejnikiem.

<b>PODŁĄCZENIA standardowe</b> <i>cena zł netto:</i>	boczne	krzyżowe	<b>opcje</b> kolor  w cenie grzejnika	dolne v 50	suszarka podłączenie pod grzałkę wodno-elekt. elektryczne	dopł.: + koszt grzałki (str. 118-119) + koszt napełnienia wg wzoru: pojemn. x 35 zł katalogowo netto
				 <b>dopl. 150 zł</b>		
<b>ZAWORY dedykowane</b> (nie są w komplecie z grzejnikiem) <i>cena zł netto:</i>	swing	vision	grzałki elektr.  (str. 118-119)	noga		
	 <b>316 zł</b>	 <b>487 zł</b>	<b>akcesoria</b>  <b>dopl. 98 zł</b>			

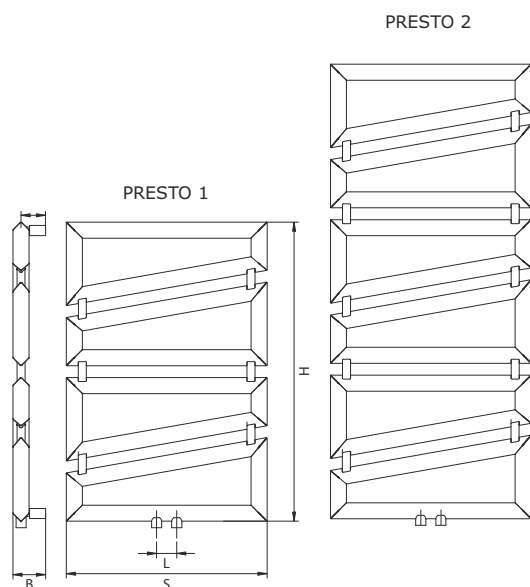
**PRESTO****GRZEJNIKI DEKORACYJNE**

B= 81 ÷ 91 mm  
C= 61 ÷ 71 mm



PRESTO	H [mm]	S [mm]	L [mm]	Pow. [m <sup>2</sup> ]	Masa [kg]	Poj. [dm <sup>3</sup> ]	Moc grzałki [W]	Moc [W]			Cena [zł netto]
								90/70/20°	75/65/20°	55/45/20°	
PRESTO 1	745	500	50	0,56	6,24	4,1	---	360	<b>290</b>	156	<b>1067</b>
PRESTO 2	1125	500	50	0,84	9,5	6,2	---	525	<b>420</b>	227	<b>1601</b>

<b>PODŁĄCZENIA standardowe</b> <i>cena zł netto:</i>	dolne v 50 		opcje kolor  w cenie grzejnika
<b>ZAWORY dedykowane</b> <small>(nie są w komplecie z grzejnikiem)</small> <i>cena zł netto:</i>	twins  <b>615 zł</b>		akcesoria

# LENTO

## GRZEJNIKI DEKORACYJNE

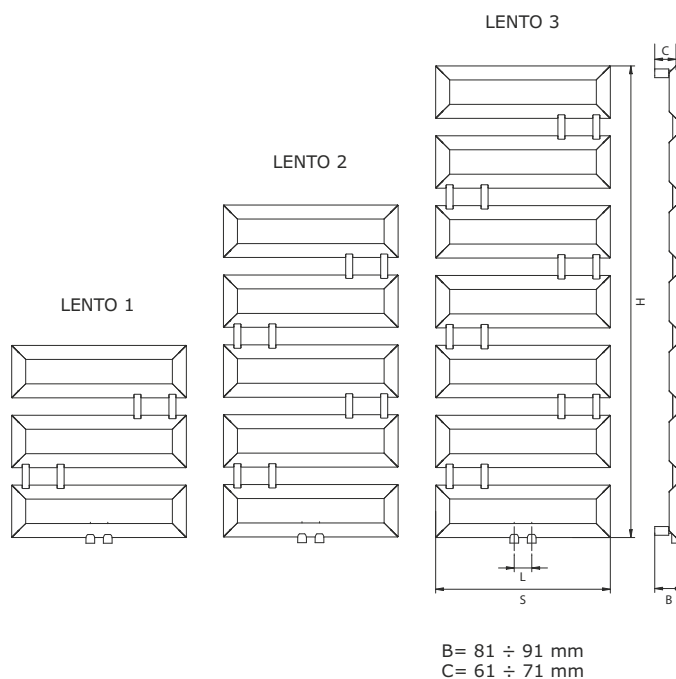
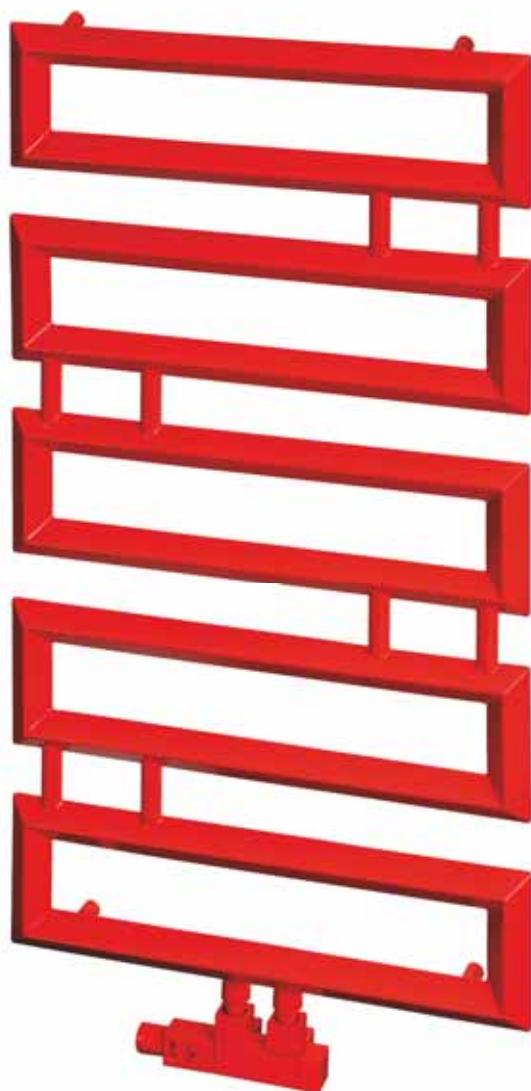

LENTO	H [mm]	S [mm]	L [mm]	Pow. [m <sup>2</sup> ]	Masa [kg]	Poj. [dm <sup>3</sup> ]	Moc grzałki [W]	Moc [W]			Cena [zł netto]
								90/70/20°	75/65/20°	55/45/20°	
LENTO 1	550	500	50	0,44	4,9	3,1	---	281	<b>225</b>	120	<b>940</b>
LENTO 2	950	500	50	0,73	8,1	5,2	---	467	<b>375</b>	201	<b>1296</b>
LENTO 3	1350	500	50	1,03	11,4	7,3	---	629	<b>505</b>	272	<b>1639</b>

Dostępny na zamówienie w wersji lewej.

<p><b>PODŁĄCZENIA standardowe</b></p> <p><i>cena zł netto:</i></p>	<p>dolne v 50</p>		<p>opcje</p> <p>KOLOR </p> <p>w cenie grzejnika</p>	
<p><b>ZAWORY dedykowane</b> (nie są w komplecie z grzejnikiem)</p> <p><i>cena zł netto:</i></p>	<p>twins</p> <p><b>615 zł</b></p>		<p>akcesoria</p>	

# BRUNO KOLOR

## GRZEJNIKI DEKORACYJNE

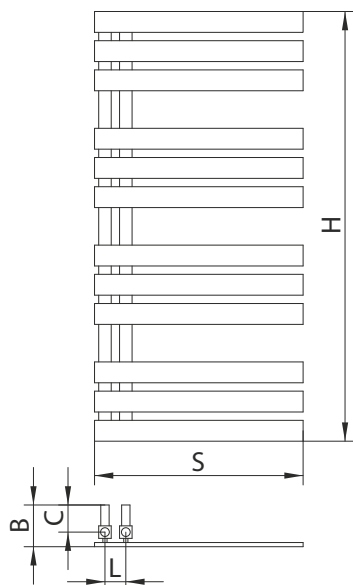

B = 100 ÷ 120 mm  
C = 65 ÷ 85 mm



BRUNO KOLOR 3

BRUNO KOLOR 2

BRUNO KOLOR 1

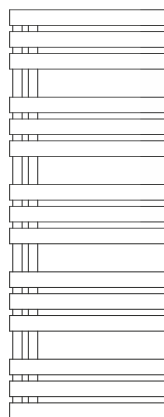

BRUNO KOLOR	H [mm]	S [mm]	L [mm]	Pow. [m <sup>2</sup> ]	Masa [kg]	Poj. [dm <sup>3</sup> ]	Moc grzałki [W]	Moc [W]			Cena [zł netto]
								90/70/20°	75/65/20°	55/45/20°	
BRUNO KOLOR 1	750	500	50	0,65	8,2	2,5	300	412	<b>330</b>	178	<b>888</b>
BRUNO KOLOR 2	1030	500	50	0,88	10,9	3,3	400	560	<b>448</b>	241	<b>1105</b>
BRUNO KOLOR 3	1310	500	50	1,09	13,6	4,2	600	705	<b>565</b>	305	<b>1334</b>

<b>PODŁĄCZENIA standardowe</b> <i>cena zł netto:</i>	dolne v 50	krzyżowe		<b>opcje</b>	kolor	wodno-elekt.	elektryczne	
<b>ZAWORY dedykowane</b> <small>(nie są w komplecie z grzejnikiem)</small> <i>cena zł netto:</i>	twins	integra		<b>akcesoria</b>	grzałki elektr.			

*cena zł netto:*

dolne v 50

krzyżowe

**opcje**

kolor

wodno-elekt.

elektryczne

w cenie grzejnika

grzałki elektr.

(str. 118-119)

dopl.:  
+ koszt grzałki  
(str. 118-119)  
+ koszt napełnienia  
wg wzoru:  
pojemn. x 35 zł  
katalogowo netto

# BRUNO T CR

## GRZEJNIKI DEKORACYJNE

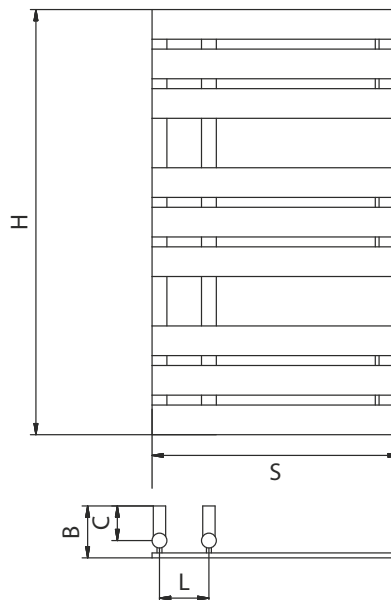

B = 105 ÷ 110 mm  
C = 70 ÷ 75 mm

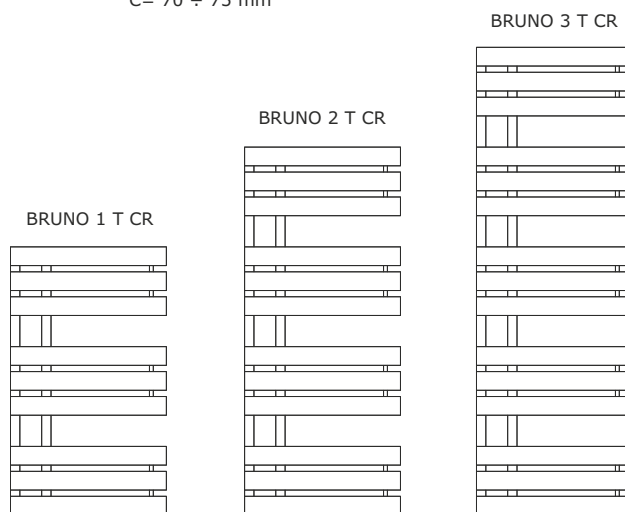

BRUNO T CR	H [mm]	S [mm]	L [mm]	Pow. [m <sup>2</sup> ]	Masa [kg]	Poj. [dm <sup>3</sup> ]	Moc grzałki [W]	Moc [W]			Cena [zł netto]
								90/70/20°	75/65/20°	55/45/20°	
BRUNO 1 T CR	860	500	100	0,76	9,4	2,9	200	270	<b>215</b>	116	2199
BRUNO 2 T CR	1180	500	100	1,02	12,8	3,9	200	360	<b>290</b>	157	2499
BRUNO 3 T CR	1500	500	100	1,28	15,8	4,9	300	457	<b>365</b>	200	2999

<b>PODŁĄCZENIA standardowe</b> <i>cena zł netto:</i>	dolne v 100	krzyżowe		<b>opcje</b>	wodno-elekt.	elektryczne	
<b>ZAWORY dedykowane</b> <small>(nie są w komplecie z grzejnikiem)</small> <i>cena zł netto:</i>	swing	vision	integra	<b>akcesoria</b>	dopł.: + koszt grzałki (str. 118-119) + koszt napiełnienia wg wzoru: pojemn. x 35 zł katalogowo netto		

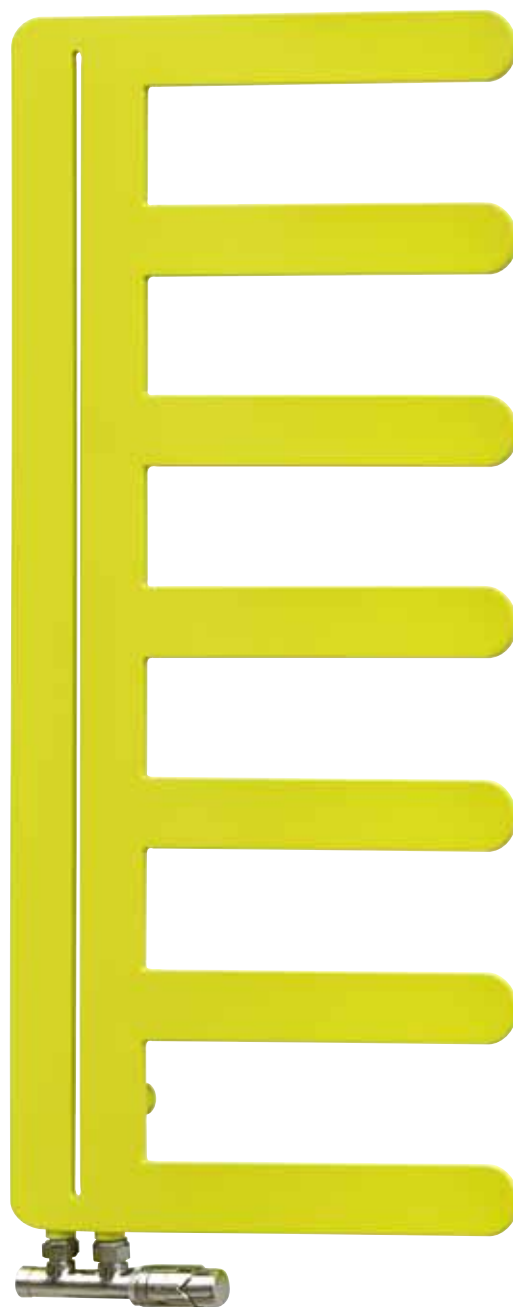
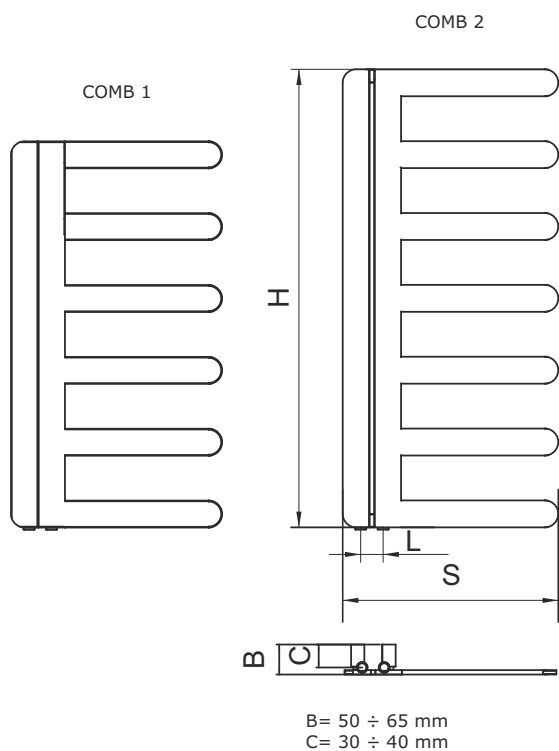
**COMB****GRZEJNIKI DEKORACYJNE**

COMB	H [mm]	S [mm]	L [mm]	Pow. [m <sup>2</sup> ]	Masa [kg]	Poj. [dm <sup>3</sup> ]	Moc grzałki [W]	Moc [W]			Cena [zł netto]
								90/70/20°	75/65/20°	55/45/20°	
COMB 1	860	480	50	0,49	6,8	1,4	---	390	<b>310</b>	170	<b>2286</b>
COMB 2	1020	480	50	0,57	7,7	1,8	---	450	<b>360</b>	190	<b>2667</b>

Dostępny w wersji prawej oraz lewej.

<b>PODŁĄCZENIA standardowe</b> <i>cena zł netto:</i>	dolne v 50 		opcje  w cenie grzejnika
<b>ZAWORY dedykowane</b> <small>(nie są w komplecie z grzejnikiem)</small> <i>cena zł netto:</i>	twins  <b>615 zł</b>		akcesoria

# EDEN

## GRZEJNIKI DEKORACYJNE

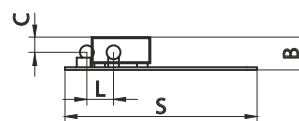
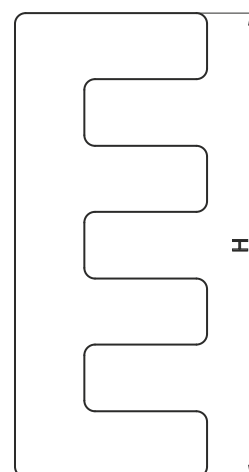
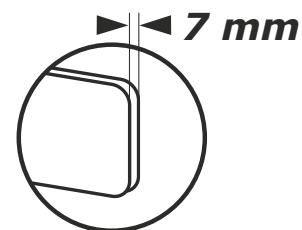

B= 63 ÷ 78 mm  
C= 30 ÷ 45 mm

EDEN	H [mm]	S [mm]	L [mm]	Pow. [m <sup>2</sup> ]	Masa [kg]	Poj. [dm <sup>3</sup> ]	Moc grzałki [W]	Moc [W]			Cena [zł netto]
								90/70/20°	75/65/20°	55/45/20°	
EDEN	870	360	50	0,47	5,5	1,0	---	306	<b>245</b>	132	1574

<b>PODŁĄCZENIA standardowe</b> <i>cena zł netto:</i>	dolne v 50 		opcje KOLOR w cenie grzejnika
<b>ZAWORY dedykowane</b> (nie są w komplecie z grzejnikiem) <i>cena zł netto:</i>	twins  <b>615 zł</b>		akcesoria

**LOFT, LOFT PLUS**  
GRZEJNIKI DEKORACYJNE

LOFT



LOFT PLUS

# LOFT, LOFT PLUS

## GRZEJNIKI DEKORACYJNE

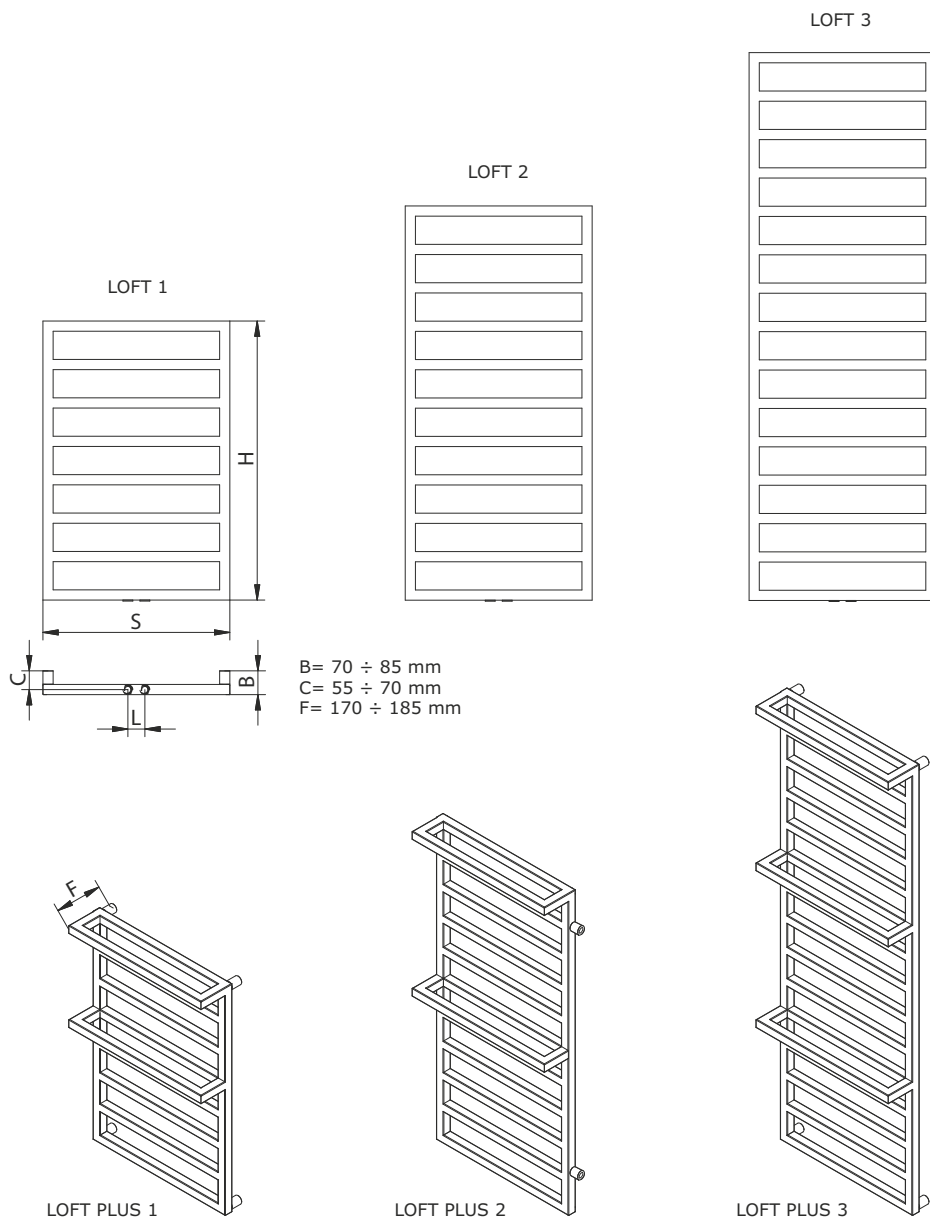

LOFT	H [mm]	S [mm]	L [mm]	Pow. [m <sup>2</sup> ]	Masa [kg]	Poj. [dm <sup>3</sup> ]	Moc grzałki [W]	Moc [W]			Cena [zł netto]
								90/70/20°	75/65/20°	55/45/20°	
LOFT 1	821	550	50	0,59	7,2	4,1	200	380	<b>305</b>	165	<b>940</b>
LOFT 2	1160	550	50	0,81	10,9	5,6	300	520	<b>415</b>	220	<b>1294</b>
LOFT 3	1612	550	50	1,08	13,9	7,7	300	650	<b>520</b>	280	<b>1668</b>
LOFT PLUS 1	821	550	50	0,73	8,9	5,0	300	465	<b>375</b>	199	<b>1258</b>
LOFT PLUS 2	1160	550	50	0,95	12,6	6,5	300	612	<b>490</b>	265	<b>1626</b>
LOFT PLUS 3	1612	550	50	1,29	16,5	9,1	600	780	<b>625</b>	335	<b>2147</b>

<b>PODŁĄCZENIA standardowe</b> <i>cena zł netto:</i>	dolne v 50	<b>opcje</b>	kolor	boczne	dolne	dodatkowa suszarka	podłączenie pod grzałkę	wodno-elekt.	elektryczne
<b>ZAWORY dedykowane</b> <small>(nie są w komplecie z grzejnikiem)</small> <i>cena zł netto:</i>	twins	<b>akcesoria</b>	grzałki elektr.	wieszak WLK 30					
	<b>615 zł</b>		(str. 118-119)	<b>dopl. 47 zł</b>		<b>dopl. 100 zł</b>	<b>dopl. 100 zł</b>		
								dopl.: + koszt grzałki (str. 118-119) + koszt napełnienia wg wzoru: pojemn. x 35 zł katalogowo netto	

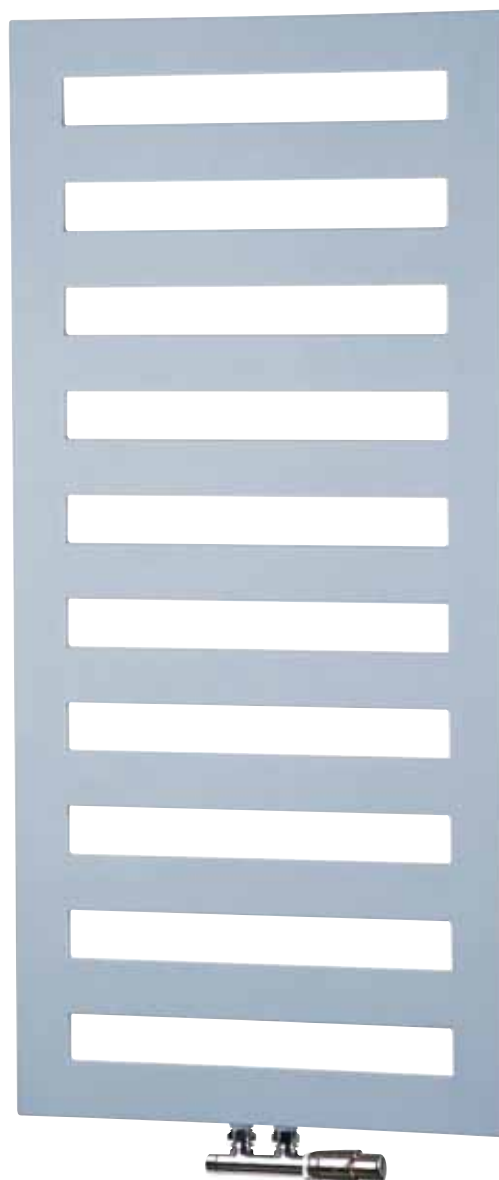
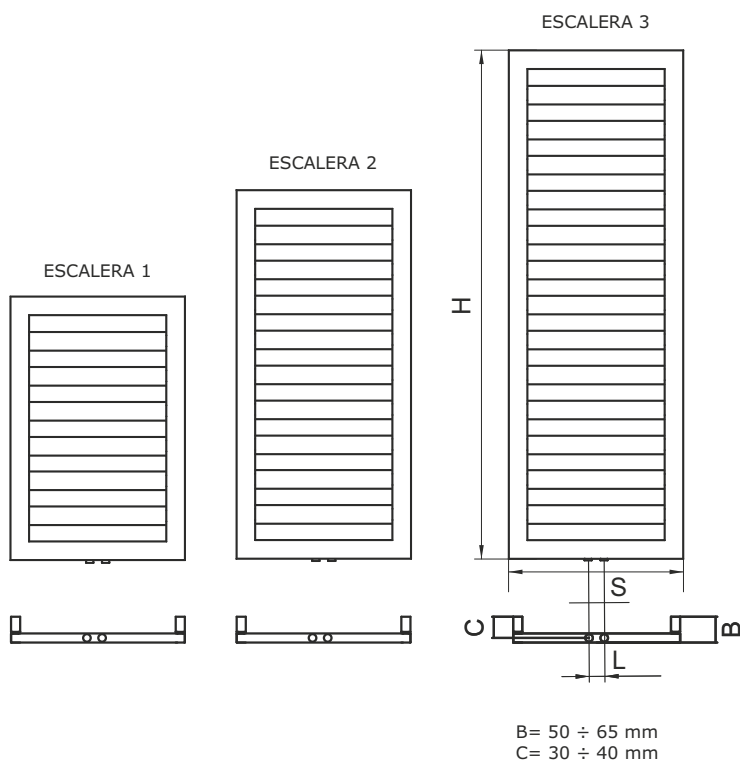
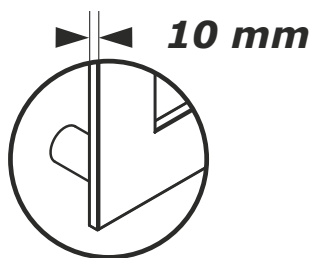
**ESCALERA****GRZEJNIKI DEKORACYJNE**

ESCALERA	H [mm]	S [mm]	L [mm]	Pow. [m <sup>2</sup> ]	Masa [kg]	Poj. [dm <sup>3</sup> ]	Moc grzałki [W]	Moc [W]			Cena [zł netto]
								90/70/20°	75/65/20°	55/45/20°	
ESCALERA 1	830	550	50	0,65	8,7	2,1	---	425	<b>340</b>	185	<b>1497</b>
ESCALERA 2	1160	550	50	0,89	11,6	2,8	---	555	<b>445</b>	240	<b>2041</b>
ESCALERA 3	1600	550	50	1,19	15,5	3,9	---	725	<b>580</b>	310	<b>2756</b>

<b>PODŁĄCZENIA standardowe</b> <i>cena zł netto:</i>	dolne v 50 		<b>opcje</b> kolor  w cenie grzejnika	dolne  <i>dopl. 100 zł</i>
<b>ZAWORY dedykowane</b> (nie są w komplecie z grzejnikiem) <i>cena zł netto:</i>	twins  <b>615 zł</b>		<b>akcesoria</b> wieszak WLK 10  <i>dopl. 58 zł</i>	

# ROD

## GRZEJNIKI DEKORACYJNE

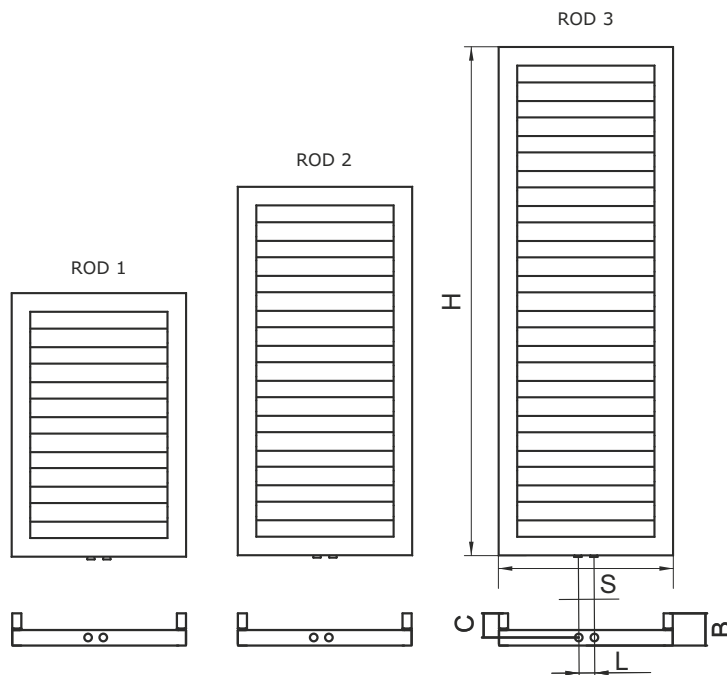
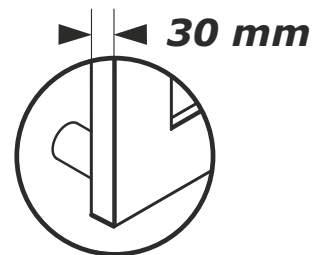

B= 70 ÷ 85 mm  
C= 55 ÷ 65 mm

ROD	H [mm]	S [mm]	L [mm]	Pow. [m <sup>2</sup> ]	Masa [kg]	Poj. [dm <sup>3</sup> ]	Moc grzałki [W]	Moc [W]			Cena [zł netto]
								90/70/20°	75/65/20°	55/45/20°	
ROD 1	830	550	50	0,84	14,5	7,6	300	540	<b>430</b>	230	1294
ROD 2	1160	550	50	1,16	19,3	10,3	300	725	<b>580</b>	310	1796
ROD 3	1600	550	50	1,58	25,1	13,5	600	960	<b>770</b>	420	2430

<b>PODŁĄCZENIA standardowe</b> <i>cena zł netto:</i>	dolne v 50 	<b>opcje</b>	kolor  w cenie grzejnika	boczne  <i>dopl. 100 zł</i>	dolne  <i>dopl. 100 zł</i>	podłączenie pod grzałkę  <i>dopl. 100 zł</i>	wodno-elekt. 	elektryczne 
	<b>ZAWORY dedykowane</b> (nie są w komplecie z grzejnikiem) <i>cena zł netto:</i>		twins  <b>615 zł</b>	<b>akcesoria</b>	grzałki elektr.  (str. 118-119)	wieszak WLK 30  <i>dopl. 47 zł</i>		

# TENSOR

## GRZEJNIKI DEKORACYJNE

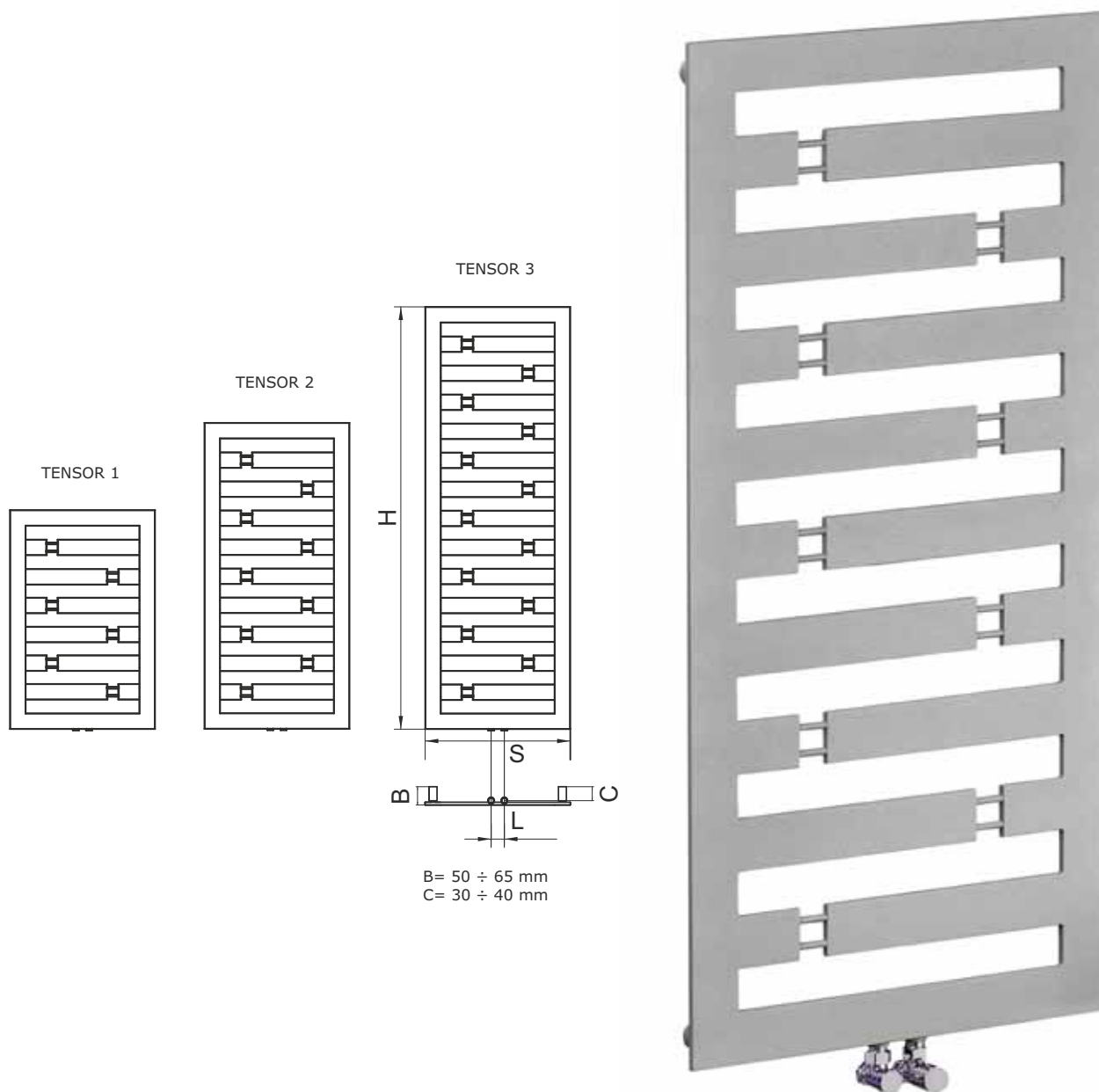

TENSOR	H [mm]	S [mm]	L [mm]	Pow. [m <sup>2</sup> ]	Masa [kg]	Poj. [dm <sup>3</sup> ]	Moc grzałki [W]	Moc [W]			Cena [zł netto]
								90/70/20°	75/65/20°	55/45/20°	
TENSOR 1	830	550	50	0,62	8,7	2,1	---	395	<b>315</b>	170	<b>2014</b>
TENSOR 2	1160	550	50	0,86	11,6	2,8	---	540	<b>430</b>	230	<b>2584</b>
TENSOR 3	1600	550	50	1,13	15,5	3,9	---	700	<b>560</b>	300	<b>3300</b>

<b>PODŁĄCZENIA standardowe</b> <i>cena zł netto:</i>	dolne v 50 		<b>opcje</b> kolor  w cenie grzejnika	dolne  <b>dopl. 100 zł</b>	
<b>ZAWORY dedykowane</b> <small>(nie są w komplecie z grzejnikiem)</small> <i>cena zł netto:</i>	twins  <b>615 zł</b>		<b>akcesoria</b>		

# VIBO

## GRZEJNIKI DEKORACYJNE

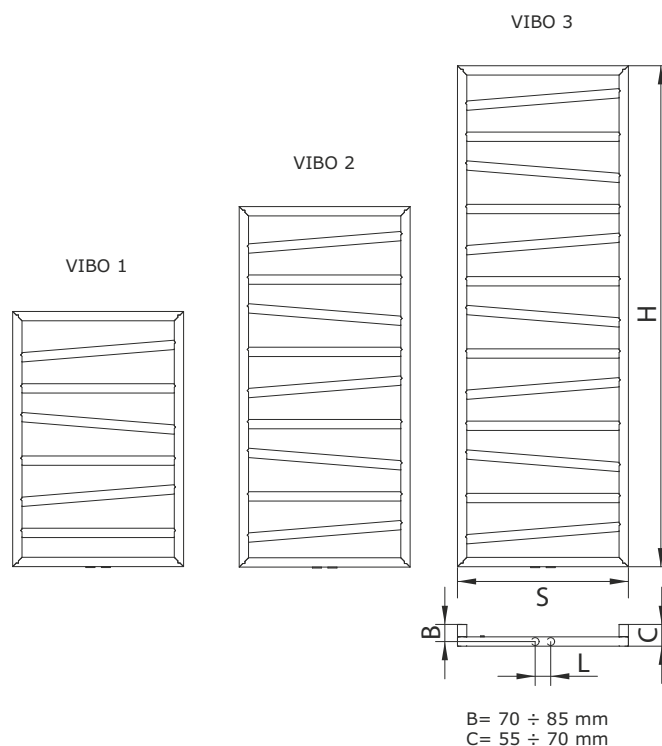

VIBO	H [mm]	S [mm]	L [mm]	Pow. [m <sup>2</sup> ]	Masa [kg]	Poj. [dm <sup>3</sup> ]	Moc grzałki [W]	Moc [W]			Cena [zł netto]
								90/70/20°	75/65/20°	55/45/20°	
VIBO 1	821	550	50	0,59	7,2	4,1	300	380	<b>305</b>	165	<b>940</b>
VIBO 2	1160	550	50	0,81	10,9	5,6	300	520	<b>415</b>	220	<b>1294</b>
VIBO 3	1612	550	50	1,08	13,9	7,7	300	650	<b>520</b>	280	<b>1668</b>

<b>PODŁĄCZENIA standardowe</b> <i>cena zł netto:</i>	dolne v 50	<b>opcje</b>	kolor	boczne	dolne	podłączenie pod grzałkę <i>dopl. 100 zł</i>	wodno-elekt. 	elektryczne 
			KOLOR w cenie grzejnika	<i>dopl. 100 zł</i>	<i>dopl. 100 zł</i>			
<b>ZAWORY dedykowane</b> (nie są w komplecie z grzejnikiem) <i>cena zł netto:</i>	twins	<b>akcesoria</b>	grzałki elektr.	wieszak WLK 30				dopl.: + koszt grzałki (str. 118-119) + koszt napełnienia wg wzoru: pojemn. x 35 zł katalogowo netto
	<b>615 zł</b>		(str. 118-119)	<i>dopl. 47 zł</i>				

# KALDERA (UGO K)

## GRZEJNIKI DEKORACYJNE

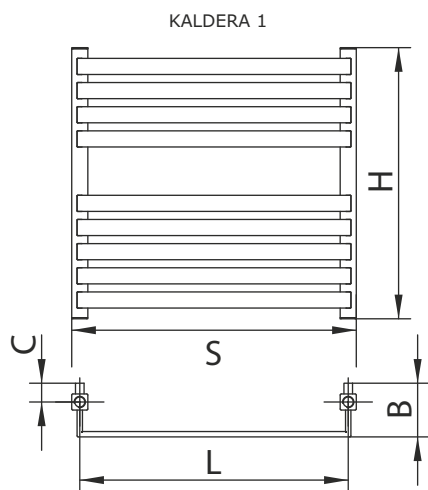

B= 45 ÷ 50 mm  
C= 110 ÷ 115 mm

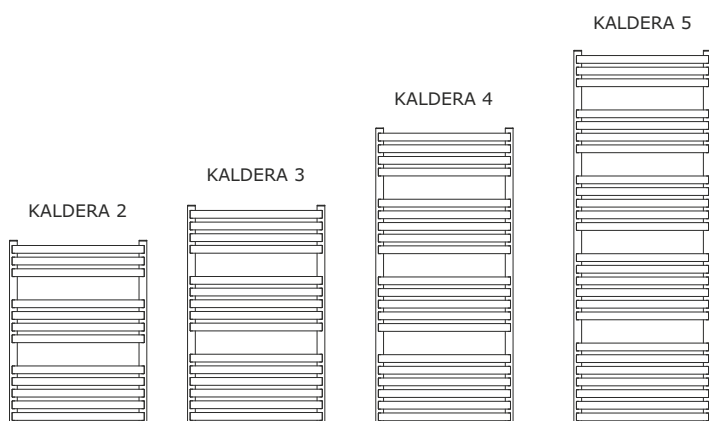

KALDERA	H [mm]	S [mm]	L [mm]	Pow. [m <sup>2</sup> ]	Masa [kg]	Poj. [dm <sup>3</sup> ]	Moc grzałki [W]	Moc [W]			Cena [zł netto]
								90/70/20°	75/65/20°	55/45/20°	
KALDERA 1 (AK1-500/U)	505	530	500	0,47	4,1	1,7	300	380	<b>305</b>	165	<b>675</b>
KALDERA 2 (AK2-500/U)	715	530	500	0,64	7,0	2,3	300	500	<b>400</b>	216	<b>886</b>
KALDERA 3 (AK3-500/U)	850	530	500	0,79	8,7	2,8	300	613	<b>490</b>	265	<b>1094</b>
KALDERA 4 (AK4-500/U)	1150	530	500	1,06	11,7	3,8	600	806	<b>645</b>	350	<b>1267</b>
KALDERA 5 (AK5-500/U)	1450	530	500	1,33	14,8	4,9	600	975	<b>785</b>	420	<b>1436</b>

<b>PODŁĄCZENIA standardowe</b> <i>cena zł netto:</i>	dolne	krzyżowe			<b>opcje</b>	kolor	wodno-elekr.	elektryczne	
<b>ZAWORY dedykowane</b> <small>(nie są w komplecie z grzejnikiem)</small> <i>cena zł netto:</i>	swing	vision	integra	unico	<b>akcesoria</b>	grzałki elektr.			
							dopł.: + koszt grzałki (str. 118-119) + koszt napełnienia wg wzoru: pojemn. x 35 zł katalogowo netto		
	<b>267 zł</b>	<b>450 zł</b>	<b>622 zł</b>	<b>627 zł</b>		(str. 118-119)			

# BARI

## GRZEJNIKI DEKORACYJNE

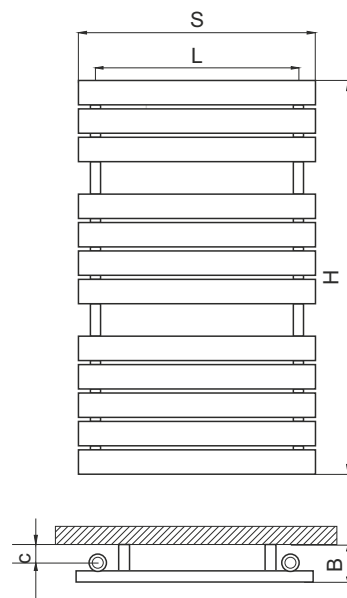

B = 70 ÷ 90 mm  
C = 45 ÷ 65 mm

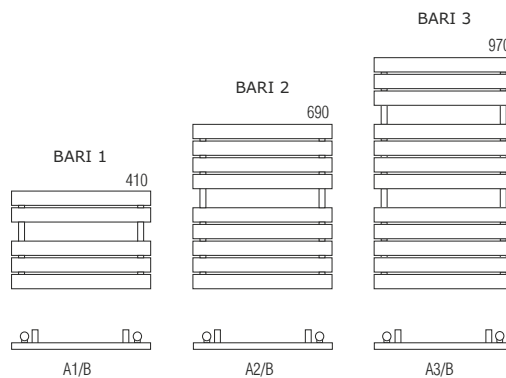

BARI	H [mm]	S [mm]	L [mm]	Pow. [m <sup>2</sup> ]	Masa [kg]	Poj. [dm <sup>3</sup> ]	Moc grzałki [W]	Moc [W]			Cena [zł netto]
								90/70/20°	75/65/20°	55/45/20°	
A1-450/B (BARI 1)	410	550	450	0,46	5,5	1,7	300	370	<b>300</b>	155	<b>766</b>
A2-450/B (BARI 2)	690	550	450	0,82	9,5	2,9	300	640	<b>510</b>	280	<b>1085</b>
A3-450/B (BARI 3)	970	550	450	1,11	13,5	3,4	600	840	<b>670</b>	350	<b>1400</b>

<b>PODŁĄCZENIA standardowe</b> <i>cena zł netto:</i>	dolne	krzyżowe	dolne w 50		<b>opcje</b>	kolor	wodno-elekt.	elektryczne	
<b>ZAWORY dedykowane</b> <small>(nie są w komplecie z grzejnikiem)</small> <i>cena zł netto:</i>	swing	vision	integra	unico	<b>akcesoria</b>	grzałki elektr.			

## AXE

## GRZEJNIKI DEKORACYJNE

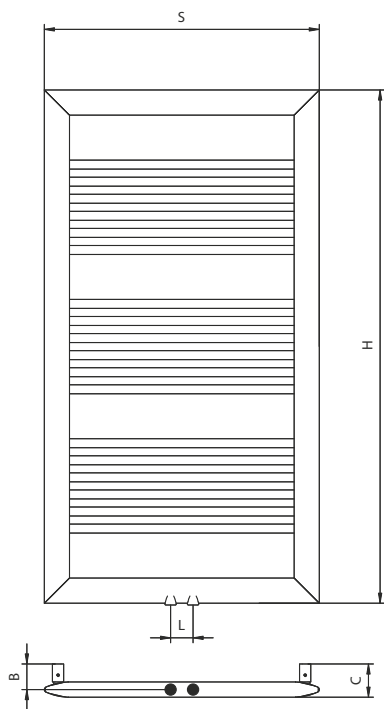

B= 65 ÷ 75 mm  
C= 70 ÷ 80 mm



AXE	H [mm]	S [mm]	L [mm]	Pow. [m <sup>2</sup> ]	Masa [kg]	Poj. [dm <sup>3</sup> ]	Moc grzałki [W]	Moc [W]			Cena [zł netto]
								90/70/20°	75/65/20°	55/45/20°	
AXE	1150	500	50	0,86	9,0	4,5	300	635	<b>510</b>	275	<b>879</b>

<b>PODŁĄCZENIA standardowe</b> <i>cena zł netto:</i>	dolne v 50 		<b>opcje</b>	kolor  w cenie grzejnika	wodno-elekt. 	elektryczne 	
<b>ZAWORY dedykowane</b> <small>(nie są w komplecie z grzejnikiem)</small> <i>cena zł netto:</i>	twins  <b>615 zł</b>		<b>akcesoria</b>	grzałki elektr.  (str. 118-119)		dopł.: + koszt grzałki (str. 118-119) + koszt napełnienia wg wzoru: pojemn. x 35 zł katalogowo netto	

# ZORBA

## GRZEJNIKI DEKORACYJNE

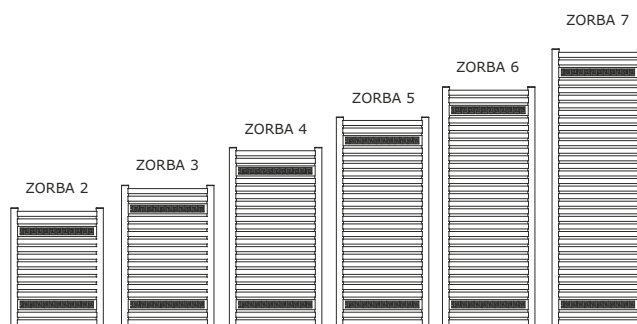
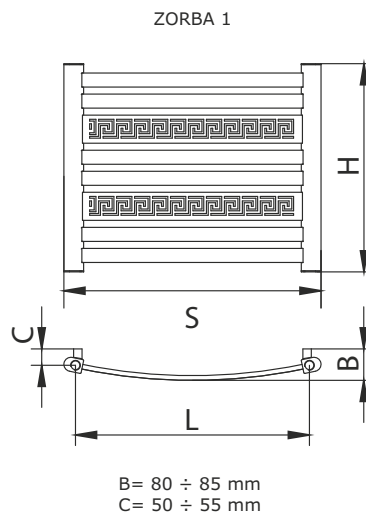

ZORBA	H [mm]	S [mm]	L [mm]	Pow. [m <sup>2</sup> ]	Masa [kg]	Poj. [dm <sup>3</sup> ]	Moc grzałki [W]	Moc [W]			Cena [zł netto]
								90/70/20°	75/65/20°	55/45/20°	
ZORBA 1	445	550	500	0,33	4,1	1,1	200	250	<b>200</b>	110	746
ZORBA 2	715	550	500	0,58	7,6	2,4	300	410	<b>330</b>	180	929
ZORBA 3	850	550	500	0,71	8,4	2,9	300	505	<b>405</b>	220	1057
ZORBA 4	1075	550	500	0,86	11,2	3,4	300	590	<b>470</b>	250	1146
ZORBA 5	1255	550	500	1,03	12,7	4,2	300	720	<b>575</b>	310	1280
ZORBA 6	1435	550	500	1,19	14,1	4,9	600	820	<b>655</b>	350	1400
ZORBA 7	1660	550	500	1,37	16,3	5,6	600	940	<b>750</b>	405	1590

<b>PODŁĄCZENIA standardowe</b> cena zł netto:	dolne 	krzyżowe 			opcje kolor  w cenie grzejnika	wodno-elekt. 	elektryczne 	
	ZAWORY dedykowane (nie są w komplecie z grzejnikiem) cena zł netto:	swing  267 zł	vision  450 zł	integra  622 zł		unico  627 zł	akcesoria grzałki elektr.  (str. 118-119)	dopł.: + koszt grzałki (str. 118-119) + koszt napełnienia wg wzoru: pojemn. x 35 zł katalogowo netto

## ALVO

## GRZEJNIKI DEKORACYJNE

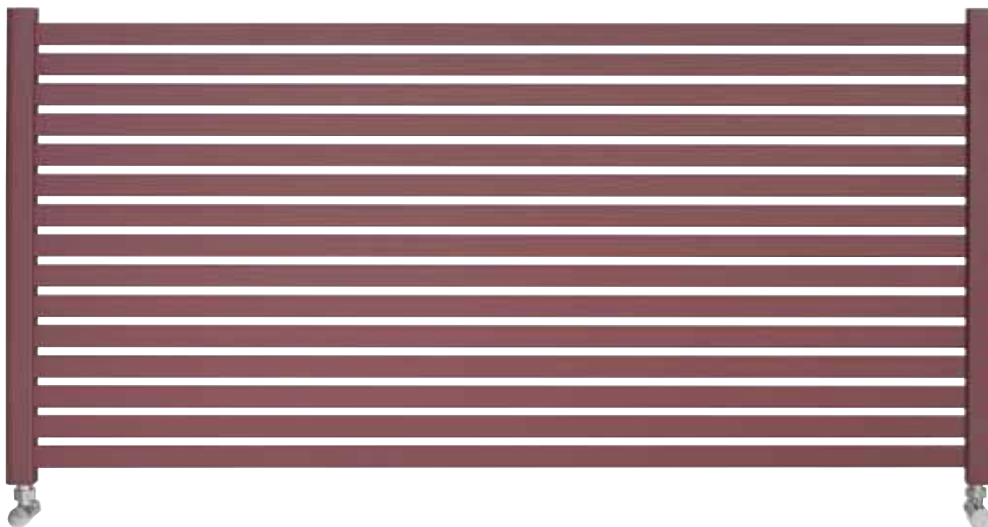

ALVO 5

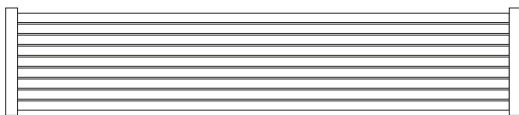

ALVO 6

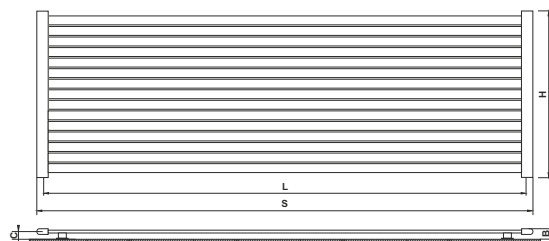

B= 60 ÷ 70 mm  
C= 45 ÷ 55 mm

ALVO	H [mm]	S [mm]	L [mm]	Pow. [m <sup>2</sup> ]	Masa [kg]	Poj. [dm <sup>3</sup> ]	Moc grzałki [W]	Moc [W]			Cena [zł netto]
								90/70/20°	75/65/20°	55/45/20°	
ALVO 1	350	1000	950	0,71	7,0	1,9	---	540	<b>430</b>	230	<b>842</b>
ALVO 2	630	1000	950	1,35	13,1	3,5	---	950	<b>760</b>	410	<b>1322</b>
ALVO 3	350	1300	1250	0,88	9,0	2,3	---	660	<b>530</b>	290	<b>963</b>
ALVO 4	630	1300	1250	1,65	16,8	4,3	---	1170	<b>935</b>	505	<b>1456</b>
ALVO 5	350	1600	1550	1,05	11,0	2,7	---	790	<b>630</b>	340	<b>1070</b>
ALVO 6	630	1600	1550	1,96	20,6	5,1	---	1390	<b>1110</b>	600	<b>1603</b>

<b>PODŁĄCZENIA standardowe</b> <i>cena zł netto:</i>	dolne	krzyżowe		<b>opcje</b>	kolor	dolne v 50	boczne	
<b>ZAWORY dedykowane</b> <small>(nie są w komplecie z grzejnikiem)</small> <i>cena zł netto:</i>	swing	vision		<b>akcesoria</b>	wieszak WLK 10			
					<i>w cenie grzejnika</i>	<b>dopl. 100 zł</b>	<b>dopl. 100 zł</b>	
					<b>dopl. 58 zł</b>			

# TORGET H

## GRZEJNIKI DEKORACYJNE

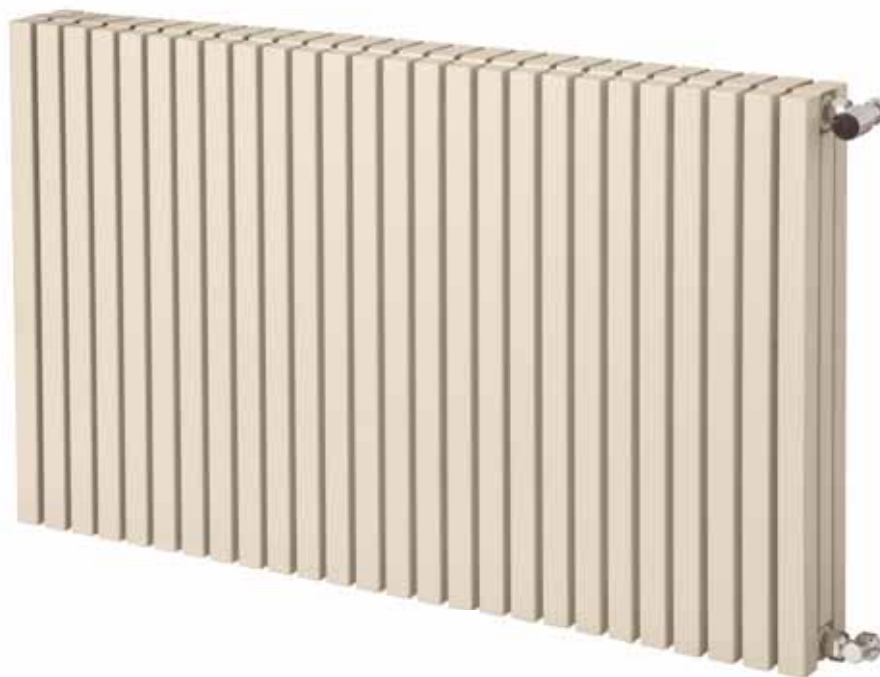

TORGET H 1

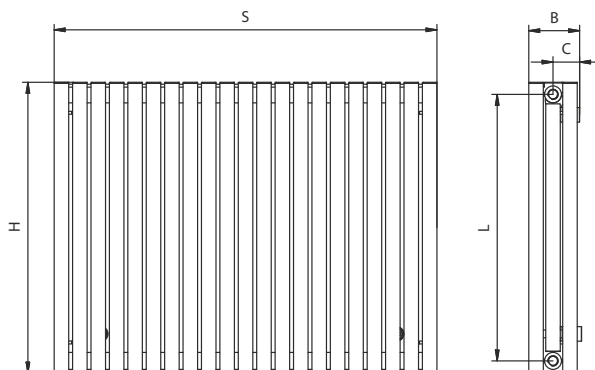

B= 105 ÷ 110 mm  
C= 55 ÷ 60 mm

TORGET H	H [mm]	S [mm]	L [mm]	Pow. [m <sup>2</sup> ]	Masa [kg]	Poj. [dm <sup>3</sup> ]	Moc grzałki [W]	Moc [W]			Cena [zł netto]
								90/70/20°	75/65/20°	55/45/20°	
TORGET H 1	600	790	550	1,65	23,2	8,8	---	730	<b>585</b>	315	<b>2226</b>
TORGET H 2	600	980	550	2,01	27,5	10,9	---	895	<b>715</b>	385	<b>2797</b>
TORGET H 3	600	1208	550	2,43	32,6	13,4	---	1085	<b>870</b>	470	<b>3270</b>
TORGET H 4	600	1398	550	2,78	36,8	15,5	---	1255	<b>1005</b>	540	<b>3776</b>

<b>PODŁĄCZENIA standardowe</b> <i>cena zł netto:</i>	boczne	krzyżowe	opcje	kolor	w cenie grzejnika
<b>ZAWORY dedykowane</b> (nie są w komplecie z grzejnikiem) <i>cena zł netto:</i>	swing	vision	akcesoria	relingi	wieszaki
	<b>267 zł</b>	<b>450 zł</b>		<i>dopł. (str. 123-124)</i>	<i>dopł. (str. 124)</i>

# TORGET PLUS

## GRZEJNIKI DEKORACYJNE

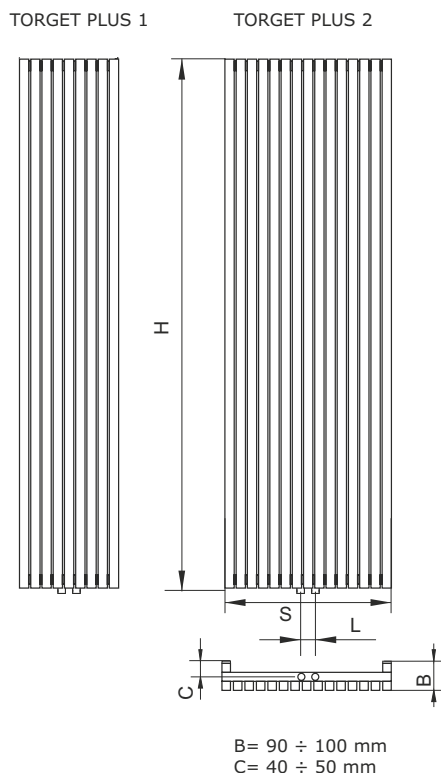

TORGET PLUS	H [mm]	S [mm]	L [mm]	Pow. [m <sup>2</sup> ]	Masa [kg]	Poj. [dm <sup>3</sup> ]	Moc grzałki [W]	Moc [W]			Cena [zł netto]
								90/70/20°	75/65/20°	55/45/20°	
TORGET PLUS 1	1800	334	50	2,18	27,0	11,2	---	1135	<b>910</b>	490	<b>1484</b>
TORGET PLUS 2	1800	562	50	3,40	42,0	18,8	---	1840	<b>1470</b>	795	<b>2327</b>
TORGET PLUS 3	1200	334	50	1,48	18,7	7,5	---	735	<b>590</b>	315	<b>1163</b>
TORGET PLUS 4	1200	562	50	2,29	29,0	12,8	---	1185	<b>950</b>	515	<b>1853</b>

Dla wysokości H - 1600 mm cena grzejnika jest równoznaczna z ceną dla wysokości H -1800 mm.

<b>PODŁĄCZENIA standardowe</b> <i>cena zł netto:</i>	dolne v 50 		<b>opcje</b> kolor  w cenie grzejnika	
	<b>ZAWORY dedykowane</b> <small>(nie są w komplecie z grzejnikiem)</small> <i>cena zł netto:</i>	twins  <b>615 zł</b>		

# BORA

## GRZEJNIKI DEKORACYJNE

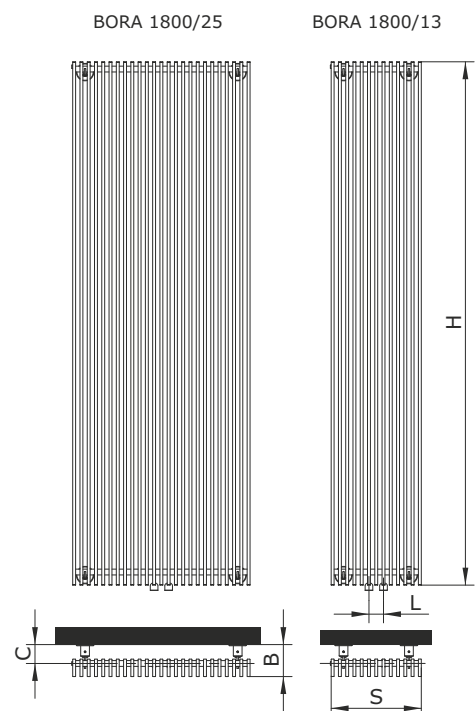
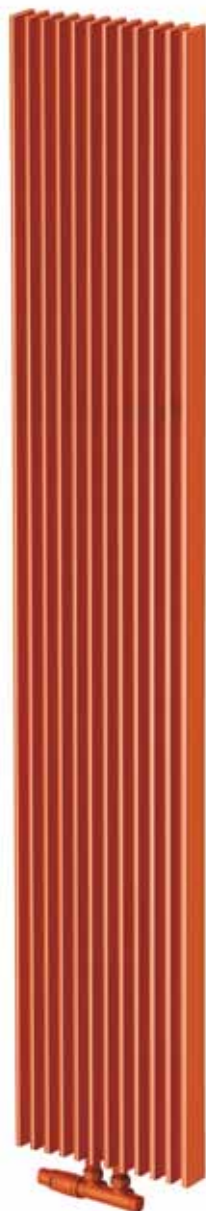

B = 110 ÷ 120 mm  
C = 65 ÷ 75 mm

BORA	H [mm]	S [mm]	L [mm]	Pow. [m <sup>2</sup> ]	Masa [kg]	Poj. [dm <sup>3</sup> ]	Moc grzałki [W]	Moc [W]			Cena [zł netto]
								90/70/20°	75/65/20°	55/45/20°	
BORA 1800/13	1800	310	50	3,29	39	9,4	---	2010	<b>1610</b>	810	2484
BORA 1800/17	1800	410	50	4,31	49	12,2	---	2545	<b>1990</b>	1005	3149
BORA 1800/21	1800	510	50	5,32	60	15,1	---	3000	<b>2350</b>	1185	3549
BORA 1800/25	1800	610	50	6,33	71	18,0	---	3820	<b>3060</b>	1540	4578
BORA 1200/13	1200	310	50	2,2	27	6,3	---	1350	<b>1080</b>	570	2204
BORA 1200/17	1200	410	50	2,88	34	8,2	---	1760	<b>1410</b>	740	2820
BORA 1200/21	1200	510	50	3,55	41	10,2	---	2156	<b>1720</b>	905	3440
BORA 1200/25	1200	610	50	4,23	48	12,1	---	2570	<b>2060</b>	1085	4074
BORA 600/13	600	310	50	1,11	15	3,1	---	760	<b>610</b>	320	1768
BORA 600/17	600	410	50	1,45	18	4,1	---	990	<b>790</b>	415	2268
BORA 600/21	600	510	50	1,79	22	5,0	---	1205	<b>960</b>	505	2777
BORA 600/25	600	610	50	2,13	26	6,0	---	1440	<b>1150</b>	605	3287

<b>PODŁĄCZENIA standardowe</b> <i>cena zł netto:</i>	dolne v 50 		opcje kolor  w cenie grzejnika	
	<b>ZAWORY dedykowane</b> (nie są w komplecie z grzejnikiem) <i>cena zł netto:</i>	twins 		615 zł

## CAJA

## GRZEJNIKI DEKORACYJNE

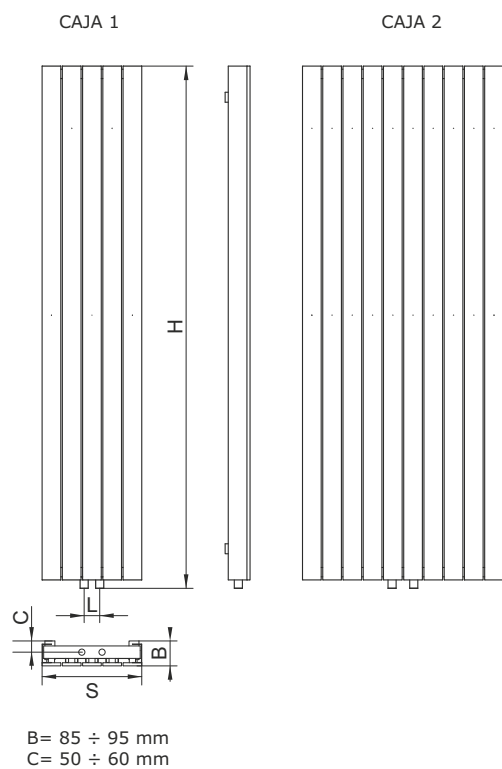

CAJA	H [mm]	S [mm]	L [mm]	Pow. [m <sup>2</sup> ]	Masa [kg]	Poj. [dm <sup>3</sup> ]	Moc grzałki [W]	Moc [W]			Cena [zł netto]
								90/70/20°	75/65/20°	55/45/20°	
CAJA 1	1650	320	50	1,49	21,0	3,5	---	1050	<b>860</b>	465	<b>1944</b>
CAJA 2	1650	645	50	2,92	42,0	7,1	---	2010	<b>1610</b>	870	<b>2782</b>
CAJA 3	1200	320	50	1,08	16,0	2,5	---	780	<b>620</b>	335	<b>1690</b>
CAJA 4	1200	645	50	2,11	32,0	5,1	---	1470	<b>1180</b>	635	<b>2503</b>

<b>PODŁĄCZENIA standardowe</b> <i>cena zł netto:</i>	dolne v 50 		<b>opcje</b> kolor 	
<b>ZAWORY dedykowane</b> <small>(nie są w komplecie z grzejnikiem)</small> <i>cena zł netto:</i>	twins 		<b>akcesoria</b> relingi 	wieszaki 
	<b>615 zł</b>		<i>dopl. (str. 123-124)</i>	<i>dopl. (str. 124)</i>

# CALLE

## GRZEJNIKI DEKORACYJNE



CALLE 1

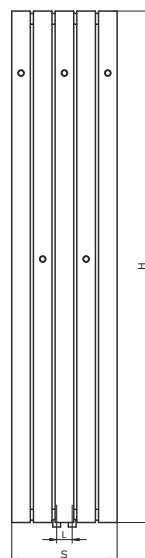

CALLE 2

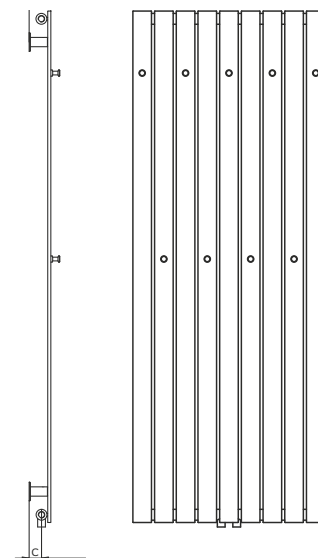

B= 75 ÷ 95 mm  
C= 45 ÷ 65 mm  
G= 30 mm

CALLE	H [mm]	S [mm]	L [mm]	Pow. [m <sup>2</sup> ]	Masa [kg]	Poj. [dm <sup>3</sup> ]	Moc grzałki [W]	Moc [W]			Cena [zł netto]
								90/70/20°	75/65/20°	55/45/20°	
CALLE 1	1650	340	50	0,95	14,0	2,8	---	690	<b>550</b>	285	<b>1563</b>
CALLE 2	1650	620	50	1,71	25,2	5,1	---	1190	<b>950</b>	495	<b>2147</b>
CALLE 3	1200	340	50	0,67	11,9	2,1	---	495	<b>395</b>	205	<b>1374</b>
CALLE 4	1200	620	50	1,19	20,9	3,7	---	860	<b>690</b>	360	<b>1895</b>

Wieszak dopasowany okrągły WDO w komplecie z grzejnikiem. Dla grzejnika CALLE 1 i 3 - 5 szt., CALLE 2 i 4 - 9 szt.

<b>PODŁĄCZENIA standardowe</b> <i>cena zł netto:</i>	dolne v 50 		<b>opcje</b>	kolor 	wieszaki  Większa ilość wieszaków WDO w grzejniku Calle jest dodatkowo płatna.
	<b>ZAWORY dedykowane</b> (nie są w komplecie z grzejnikiem) <i>cena zł netto:</i>	twins 			

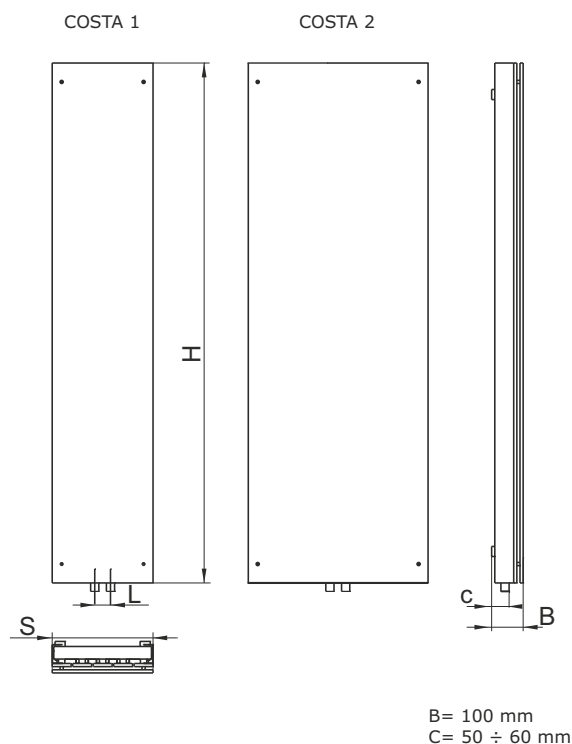
**COSTA****GRZEJNIKI DEKORACYJNE**

COSTA	H [mm]	S [mm]	L [mm]	Pow. [m <sup>2</sup> ]	Masa [kg]	Poj. [dm <sup>3</sup> ]	Moc grzałki [W]	Moc [W]			Cena [zł netto]
								90/70/20°	75/65/20°	55/45/20°	
COSTA 1	1650	340	50	1,49	36	3,5	---	1050	<b>860</b>	460	<b>3500</b>
COSTA 2	1650	620	50	3,99	72	7,1	---	2050	<b>1610</b>	870	<b>4900</b>

<b>PODŁĄCZENIA standardowe</b> <i>cena zł netto:</i>	dolne v 50 		<b>opcje</b>  kolor wzór na grzejniku możliwość wyboru wzoru str. 126 w cenie grzejnika
<b>ZAWORY dedykowane</b> <small>(nie są w komplecie z grzejnikiem)</small> <i>cena zł netto:</i>	twins  <b>615 zł</b>		<b>akcesoria</b>



# CLEO

## GRZEJNIKI DEKORACYJNE

z lustrem w odcieniu grafitowym



Opcjonalnie górne mocowania lustra w postaci wieszaków.

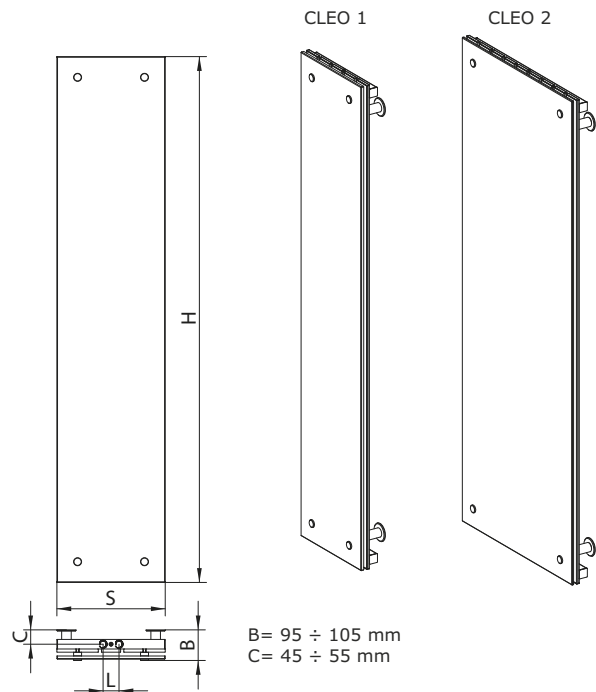

CLEO	H [mm]	S [mm]	L [mm]	Pow. [m <sup>2</sup> ]	Masa [kg]	Poj. [dm <sup>3</sup> ]	Moc grzałki [W]	Moc [W]			Cena [zł netto]
								90/70/20°	75/65/20°	55/45/20°	
CLEO 1	1650	340	50	0,95	14	2,8	---	590	<b>465</b>	240	1990
CLEO 2	1650	620	50	1,71	25,2	5,1	---	1010	<b>795</b>	420	2990

Przednią powierzchnię grzejnika stanowi eleganckie lustro w odcieniu czarnym. Górne elementy mocujące lustro mogą być opcjonalnie w postaci wieszaków lub płaskich mocowań.

<p><b>PODŁĄCZENIA standardowe</b></p> <p><i>cena zł netto:</i></p>	<p>dolne v 50</p>		<p>opcje</p> <p>kolor</p> <p>w cenie grzejnika</p>	
<p><b>ZAWORY dedykowane</b> <small>(nie są w komplecie z grzejnikiem)</small></p> <p><i>cena zł netto:</i></p>	<p>twins</p> <p><b>615 zł</b></p>		<p>akcesoria</p>	

Kolor grzejnika do wyboru.

## LEA

## GRZEJNIKI DEKORACYJNE

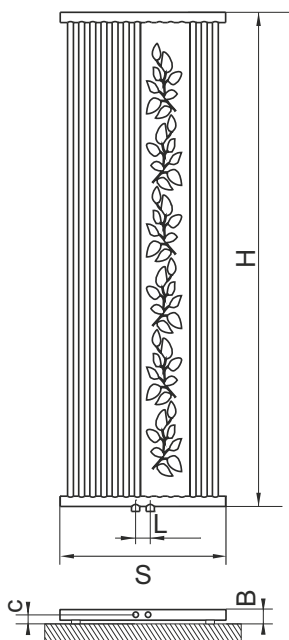

B = 100 mm  
C = 55 mm

wzory dekoracyjne:

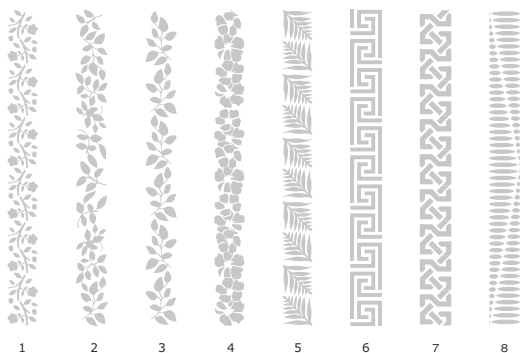

LEA	H [mm]	S [mm]	L [mm]	Pow. [m <sup>2</sup> ]	Masa [kg]	Poj. [dm <sup>3</sup> ]	Moc grzałki [W]	Moc [W]			Cena [zł netto]
								90/70/20°	75/65/20°	55/45/20°	
LEA KOLOR	1685	565	50	1,54	16	4,8	---	680	<b>540</b>	290	1533

<b>PODŁĄCZENIA standardowe</b> <i>cena zł netto:</i>	dolne v 50	krzyżowe	boczne		<b>opcje</b> kolor KOLOR  w cenie grzejnika	wzór na grzejniku możliwość wyboru wzoru	
	<b>ZAWORY dedykowane</b> <small>(nie są w komplecie z grzejnikiem)</small> <i>cena zł netto:</i>	twins					<b>akcesoria</b>

615 zł

# LUCA

## GRZEJNIKI DEKORACYJNE

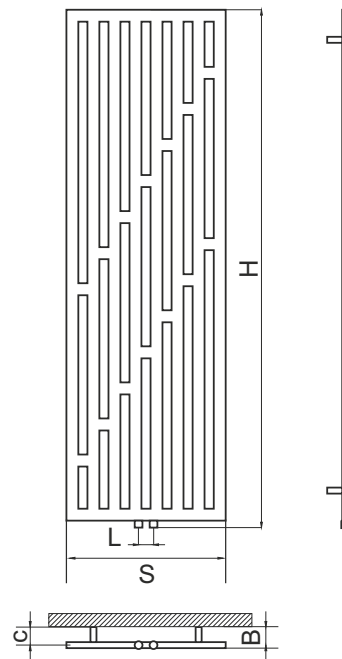
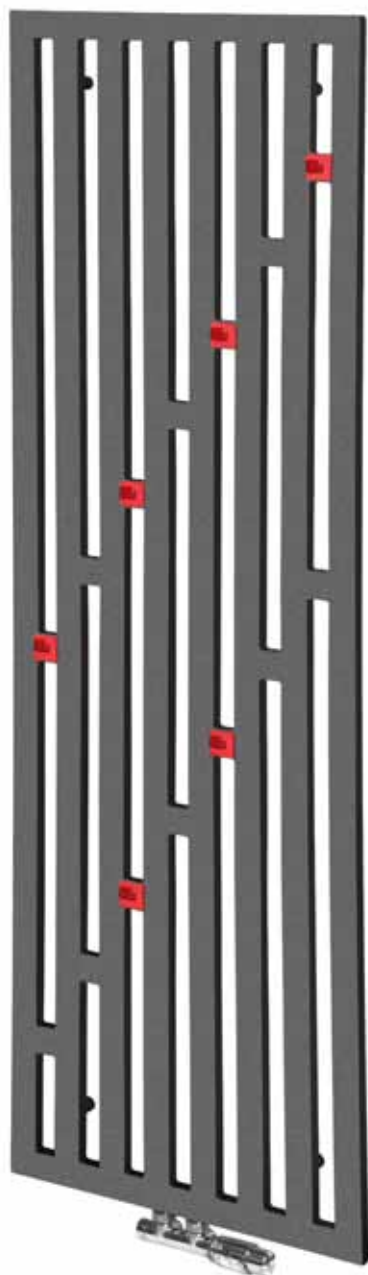

B= 75 ÷ 90 mm  
C= 65 ÷ 80 mm

LUCA	H [mm]	S [mm]	L [mm]	Pow. [m <sup>2</sup> ]	Masa [kg]	Poj. [dm <sup>3</sup> ]	Moc grzałki [W]	Moc [W]			Cena [zł netto]
								90/70/20°	75/65/20°	55/45/20°	
LUCA	1700	530	50	1,58	26,0	8,3	---	1160	<b>930</b>	500	2620

Wieszaki nie są w cenie grzejnika. Wieszaki mogą być umiejscowione na łączeniach kanałów pionowych (jak na zdjęciu) i mogą być pomalowane na dowolny kolor z naszej palety kolorów).

<b>PODŁĄCZENIA standardowe</b> <i>cena zł netto:</i>	dolne v 50 		<b>opcje</b>	kolor  w cenie grzejnika	dolne  <b>dopl. 100 zł</b>	
<b>ZAWORY dedykowane</b> (nie są w komplecie z grzejnikiem) <i>cena zł netto:</i>	twins  <b>615 zł</b>		<b>akcesoria</b>	wieszaki  <b>dopl. (str. 124)</b>		

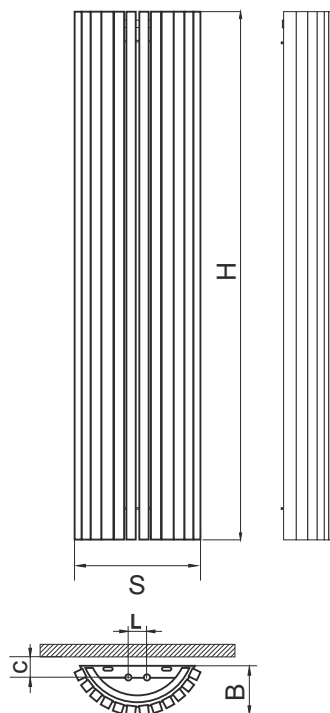
**CARRERA P****GRZEJNIKI DEKORACYJNE**

B= 235 mm  
C= 40 mm



CARRERA P	H [mm]	S [mm]	L [mm]	Pow. [m <sup>2</sup> ]	Masa [kg]	Poj. [dm <sup>3</sup> ]	Moc grzałki [W]	Moc [W]			Cena [zł netto]
								90/70/20°	75/65/20°	55/45/20°	
CARRERA P	1800	430	50	2,4	33,0	10,3	---	1730	<b>1380</b>	725	2756

Przy zamówieniu proszę podać stronę zasilania w grzejniku.

<b>PODŁĄCZENIA standardowe</b> <i>cena zł netto:</i>	dolne v 50 		opcje  w cenie grzejnika	
<b>ZAWORY dedykowane</b> <small>(nie są w komplecie z grzejnikiem)</small> <i>cena zł netto:</i>	twins  <b>615 zł</b>		akcesoria	

# CARRERA N

## GRZEJNIKI DEKORACYJNE

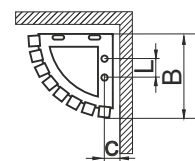
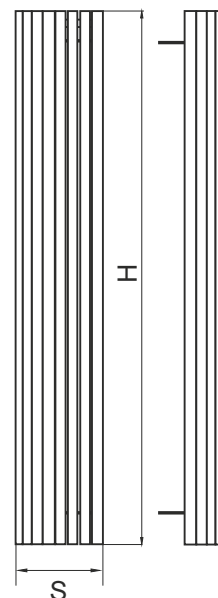
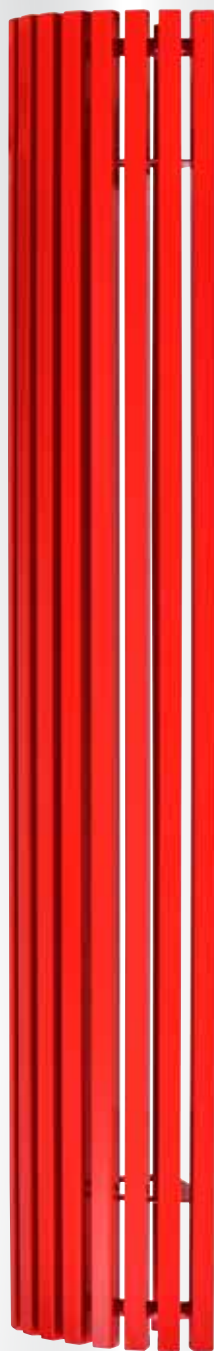

B= 170 mm  
C= 40 mm

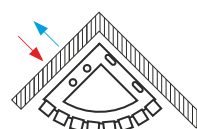

forma lewa

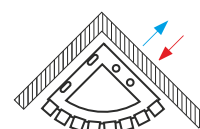

forma prawa

CARRERA N	H [mm]	S [mm]	L [mm]	Pow. [m <sup>2</sup> ]	Masa [kg]	Poj. [dm <sup>3</sup> ]	Moc grzałki [W]	Moc [W]	Cena [zł netto]
CARRERA N	1800	235	50	1,6	23,0	6,8	---	90/70/20° 1170 75/65/20° <b>940</b> 55/45/20° 495	2348

Przy zamówieniu proszę podać str.ony podłączenia (może być odręczy rysunek).

<b>PODŁĄCZENIA standardowe</b> <i>cena zł netto:</i>	dolne v 50 		opcje kolor w cenie grzejnika
<b>ZAWORY dedykowane</b> (nie są w komplecie z grzejnikiem) <i>cena zł netto:</i>	twins 615 zł		akcesoria



# ORRO

## GRZEJNIKI DEKORACYJNE

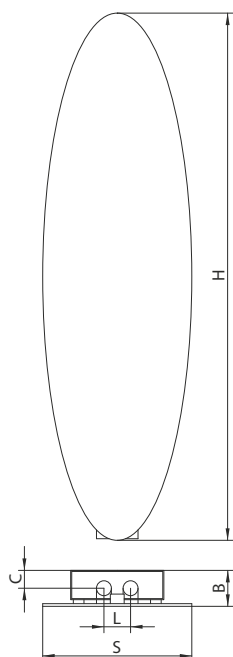
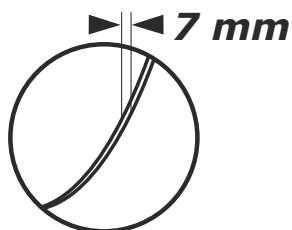

B= 68 ÷ 83 mm  
C= 35 ÷ 50 mm



ORRO	H [mm]	S [mm]	L [mm]	Pow. [m <sup>2</sup> ]	Masa [kg]	Poj. [dm <sup>3</sup> ]	Moc grzałki [W]	Moc [W]			Cena [zł netto]
								90/70/20°	75/65/20°	55/45/20°	
ORRO	990	280	50	0,38	6,5	1,0	---	299	<b>240</b>	129	<b>1574</b>

<b>PODŁĄCZENIA standardowe</b> <i>cena zł netto:</i>	dolne v 50		<b>opcje</b>	kolor	reling
				 w cenie grzejnika	 <b>dopl. 200 zł</b>
<b>ZAWORY dedykowane</b> <small>(nie są w komplecie z grzejnikiem)</small> <i>cena zł netto:</i>	twins		<b>akcesoria</b>		
	 <b>615 zł</b>				



# VINKA

## GRZEJNIKI DEKORACYJNE

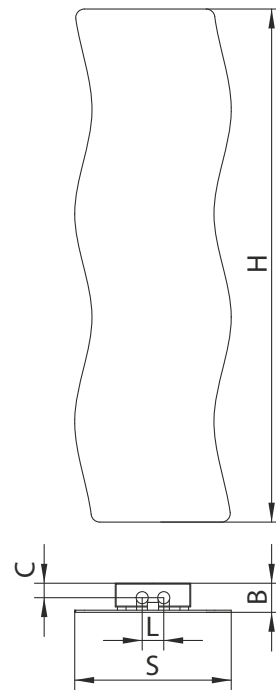
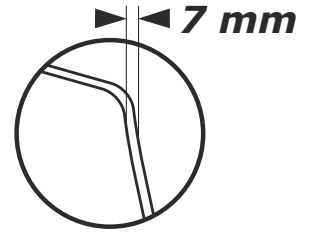

B= 68 ÷ 83 mm  
C= 35 ÷ 50 mm

VINKA	H	S	L	Pow.	Masa	Poj.	Moc grzałki [W]	Moc [W]			Cena [zł netto]
	[mm]	[mm]	[mm]	[m <sup>2</sup> ]	[kg]	[dm <sup>3</sup> ]		90/70/20°	75/65/20°	55/45/20°	
VINKA	1190	353	50	0,79	9	1,0	---	512	<b>417</b>	236	1790

<b>PODŁĄCZENIA standardowe</b> <i>cena zł netto:</i>	dolne v 50 	<b>opcje</b> kolor w cenie grzejnika	reling <b>dopl. 200 zł</b>
	<b>ZAWORY dedykowane</b> <small>(nie są w komplecie z grzejnikiem)</small> <i>cena zł netto:</i>		



## HEAVEN

## GRZEJNIKI DEKORACYJNE

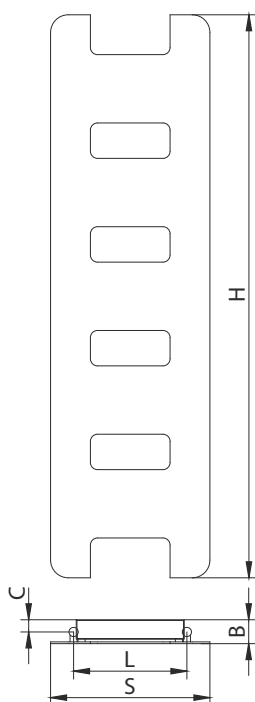
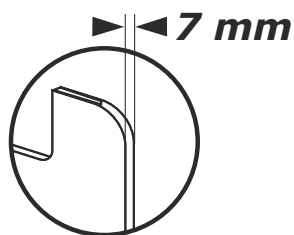

B = 68 ÷ 83 mm  
C = 35 ÷ 50 mm



HEAVEN	H [mm]	S [mm]	L [mm]	Pow. [m <sup>2</sup> ]	Masa [kg]	Poj. [dm <sup>3</sup> ]	Moc grzałki [W]	Moc [W]			Cena [zł netto]
								90/70/20°	75/65/20°	55/45/20°	
HEAVEN	1600	450	320	1,27	14,0	1,5	---	793	<b>635</b>	341	2580

<b>PODŁĄCZENIA standardowe</b> <i>cena zł netto:</i>	dolne 		<b>opcje</b> KOLOR  w cenie grzejnika
	<b>ZAWORY dedykowane</b> <small>(nie są w komplecie z grzejnikiem)</small> <i>cena zł netto:</i>	twins  <b>615 zł</b>	



# KEX GRZEJNIKI DEKORACYJNE

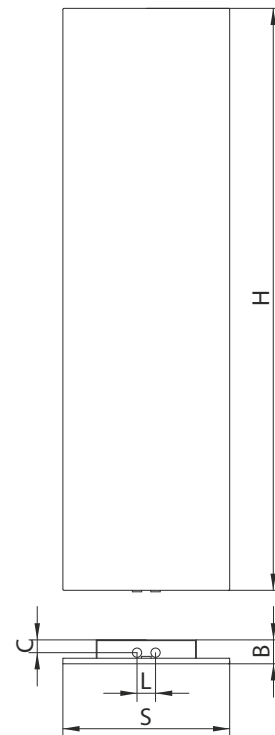
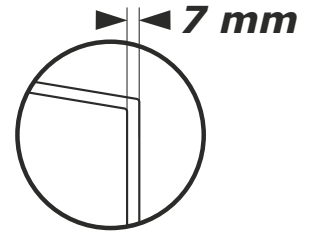

B= 67 ÷ 82 mm  
C= 35 ÷ 50 mm  
C= 117 ÷ 132 mm

KEX	H [mm]	S [mm]	L [mm]	Pow. [m <sup>2</sup> ]	Masa [kg]	Poj. [dm <sup>3</sup> ]	Moc grzałki [W]	Moc [W]			Cena [zł netto]
								90/70/20°	75/65/20°	55/45/20°	
KEX	1570	450	50	1,4	16	1,5	---	914	<b>735</b>	401	1990

Dwa relingi przykręcane chromowane są w komplecie z grzejnikiem.

<b>PODŁĄCZENIA standardowe</b> <i>cena zł netto:</i>	dolne v 50 		opcje kolor  w cenie grzejnika	
	<b>ZAWORY dedykowane</b> <small>(nie są w komplecie z grzejnikiem)</small> <i>cena zł netto:</i>	twins 		

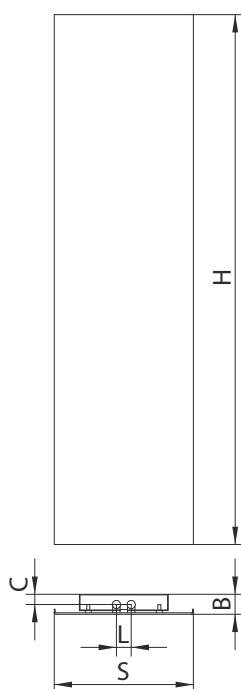
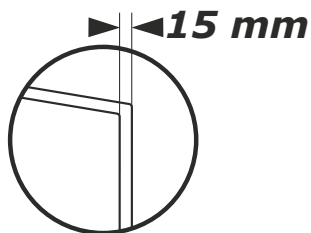
**WALL NEW****GRZEJNIKI DEKORACYJNE**

B= 68 ÷ 82 mm  
C= 35 ÷ 50 mm



WALL NEW	H [mm]	S [mm]	L [mm]	Pow. [m <sup>2</sup> ]	Masa [kg]	Poj. [dm <sup>3</sup> ]	Moc grzałki [W]	Moc [W]			Cena [zł netto]
								90/70/20°	75/65/20°	55/45/20°	
WALL NEW	1790	470	50	1,6	31	1,5	---	1002	<b>793</b>	411	2514

<b>PODŁĄCZENIA standardowe</b> <i>cena zł netto:</i>	dolne 		opcje kolor  w cenie grzejnika	
	<b>ZAWORY dedykowane</b> <small>(nie są w komplecie z grzejnikiem)</small> <i>cena zł netto:</i>	twins  <b>615 zł</b>		

# WALL

## GRZEJNIKI DEKORACYJNE

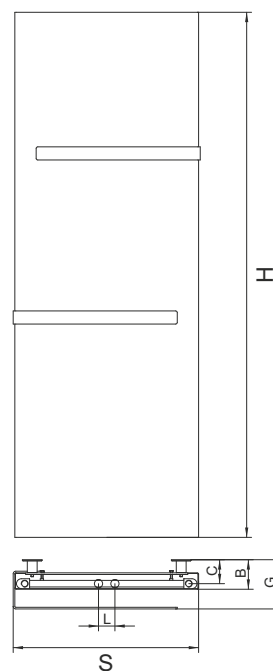

B= 90 ÷ 100 mm  
C= 75 ÷ 85 mm  
G= 150 ÷ 160 mm

WALL	H [mm]	S [mm]	L [mm]	Pow. [m <sup>2</sup> ]	Masa [kg]	Poj. [dm <sup>3</sup> ]	Moc grzałki [W]	Moc [W]			Cena [zł netto]
								90/70/20°	75/65/20°	55/45/20°	
WALL	1600	560	50	1,5	27,0	8,3	600	1020	<b>820</b>	440	<b>2465</b>
WALL Z NADRUKIEM	1600	560	50	1,5	27,0	8,3	600	1020	<b>820</b>	440	<b>3350</b>

Relingi można zamontować na trzech wysokościach. Dostępne w chromie lub palecie barw RAL i Radeco. - str. 123-124

<b>PODŁĄCZENIA standardowe</b> <i>cena zł netto:</i>	dolne v 50 		<b>opcje</b>	kolor  w cenie grzejnika	dolne 	krzyżowe 	wodno-elekt. 	elektryczne 
<b>ZAWORY dedykowane</b> (nie są w komplecie z grzejnikiem) <i>cena zł netto:</i>	twins 		<b>akcesoria</b>	relingi 				dopl.: + koszt grzałki (str. 118-119) + koszt napełnienia wg wzoru: pojemn. x 35 zł katalogowo netto

# IMPERADOR

## GRZEJNIKI DEKORACYJNE

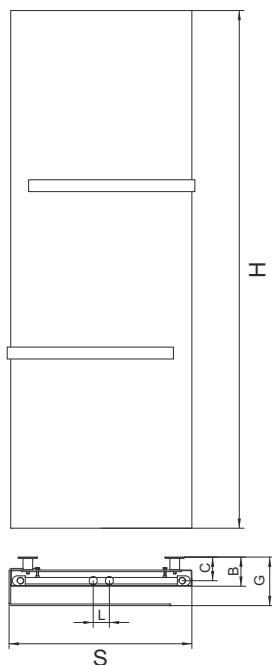

B= 90 ÷ 100 mm  
C= 75 ÷ 85 mm  
G= 150 ÷ 160 mm

wzory dekoracyjne:

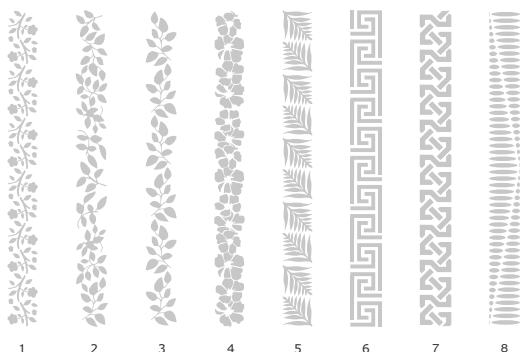

Wzór: grecki  
Reling anodowany pojedynczy kwadratowy RAK 2  
Dedykowany zestaw zaworów: Duo-Plex.

IMPERADOR	H [mm]	S [mm]	L [mm]	Pow. [m <sup>2</sup> ]	Masa [kg]	Poj. [dm <sup>3</sup> ]	Moc grzałki [W]	Moc [W]			Cena [zł netto]
								90/70/20°	75/65/20°	55/45/20°	
IMPERADOR	1600	560	50	1,5	27	8,3	600	1020	<b>820</b>	440	2859

Relingi można zamontować na trzech wysokościach. Dostępne są w kolorach: srebrnym, czarnym i czerwonym - str. 123-124

<b>PODŁĄCZENIA standardowe</b> <i>cena zł netto:</i>	dolne v 50	<b>opcje</b> kolor  w cenie grzejnika	dolne	krzyżowe	wzór na grzejniku	wodno-elekt.	elektryczne	
	<b>ZAWORY dedykowane</b> (nie są w komplecie z grzejnikiem) <i>cena zł netto:</i>		twins	<b>akcesoria</b> relingi  <i>dopl. (str. 123-124)</i>	możliwość wyboru wzoru			
							dopl.: + koszt grzałki (str. 118-119) + koszt napełnienia wg wzoru: pojemn. x 35 zł katalogowo netto	

# PARYS

## GRZEJNIKI DEKORACYJNE



PARYS 1

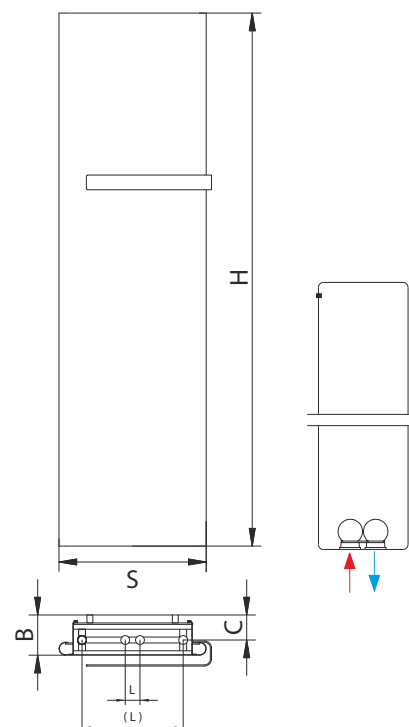

B= 135 mm  
C= 77 mm  
L= 50 mm  
(L)= 344, 444, 544 mm

PARYS	H [mm]	S [mm]	L [mm]	Pow. [m <sup>2</sup> ]	Masa [kg]	Poj. [dm <sup>3</sup> ]	Moc grzałki [W]	Moc [W]			Cena [zł netto]
								90/70/20°	75/65/20°	55/45/20°	
PARYS 1	1800	500	50	9,1	67,0	6,4	---	1390	<b>1110</b>	570	<b>4116</b>
PARYS 2	1800	600	50	12,1	82,0	8,0	---	1860	<b>1490</b>	755	<b>4421</b>
PARYS 3	1800	700	50	15,1	95,0	9,6	---	2325	<b>1860</b>	945	<b>4777</b>

W grzejniku zasilanie **ZAWSZE** z lewej strony.

Relingi można zamontować na trzech wysokościach. Dostępne są w kolorach: srebrnym, czarnym i czerwonym - str. 123

<p><b>PODŁĄCZENIA standardowe</b></p> <p><i>cena zł netto:</i></p>	<p>dolne v 50</p>		<p><b>opcje</b></p> <p>kolor</p> <p>KOLOR </p> <p>w cenie grzejnika</p>
<p><b>ZAWORY dedykowane</b> (nie są w komplecie z grzejnikiem)</p> <p><i>cena zł netto:</i></p>	<p>twins</p> <p><b>615 zł</b></p>		<p><b>akcesoria</b></p> <p>relingi</p> <p><i>dopt. (str. 123-124)</i></p>

# CORAL, CORAL LED

## GRZEJNIKI DEKORACYJNE

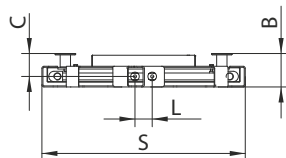
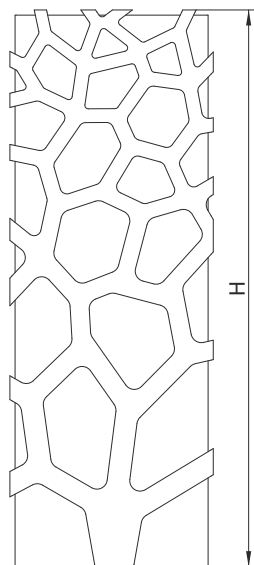

B= 100 ÷ 110 mm  
C= 70 ÷ 80 mm



CORAL	H [mm]	S [mm]	L [mm]	Pow. [m <sup>2</sup> ]	Masa [kg]	Poj. [dm <sup>3</sup> ]	Moc grzałki [W]	Moc [W]			Cena [zł netto]
								90/70/20°	75/65/20°	55/45/20°	
CORAL	1615	590	50	1,5	31	8,3	600	1020	<b>820</b>	440	<b>3164</b>
CORAL LED	1615	590	50	1,5	31	8,3	600	1020	<b>820</b>	440	<b>4115</b>

<b>PODŁĄCZENIA standardowe</b> <i>cena zł netto:</i>	dolne v 50	opcje	kolor	dolne	krzyżowe	wodno-elekt.	elektryczne
	<b>ZAWORY dedykowane</b> <small>(nie są w komplecie z grzejnikiem)</small> <i>cena zł netto:</i>		twins	 <small>w cenie grzejnika</small>			
		akcesoria					dopl.: + koszt grzałki (str. 118-119) + koszt napełnienia wg wzoru: pojemn. x 35 zł katalogowo netto

# ALBERO LED

## GRZEJNIKI DEKORACYJNE

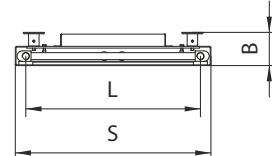
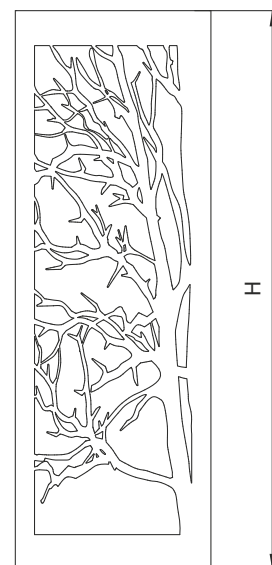

B= 110 mm

ALBERO LED	H [mm]	S [mm]	L [mm]	Pow. [m <sup>2</sup> ]	Masa [kg]	Poj. [dm <sup>3</sup> ]	Moc grzałki [W]	Moc [W]			Cena [zł netto]
								90/70/20°	75/65/20°	55/45/20°	
ALBERO LED	1600	560	50	1,5	48	8,3	600	810	<b>650</b>	350	<b>5422</b>

<b>PODŁĄCZENIA standardowe</b> <i>cena zł netto:</i>	dolne v 50 	opcje	kolor 	dolne 	krzyżowe 	wodno-elekt. 	elektryczne 
	<i>cena zł netto:</i>		w cenie grzejnika	dopł.: + koszt grzałki (str: 118-119) + koszt napełnienia wg wzoru: pojemn. x 35 zł katalogowo netto			
<b>ZAWORY dedykowane</b> (nie są w komplecie z grzejnikiem) <i>cena zł netto:</i>	twins 	akcesoria					
<i>cena zł netto:</i>	<b>615 zł</b>						

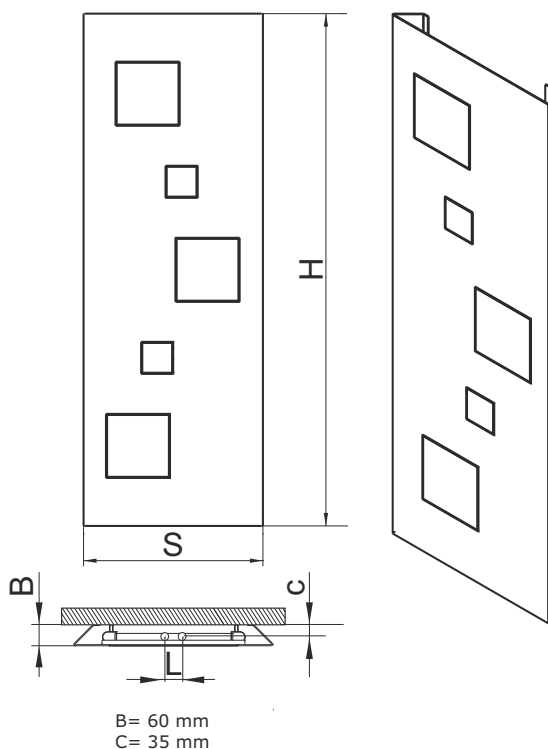
**CEDRO****GRZEJNIKI DEKORACYJNE**

CEDRO	H	S	L	Pow.	Masa	Poj.	Moc grzałki	Moc [W]			Cena [zł netto]
	[mm]	[mm]	[mm]	[m <sup>2</sup> ]	[kg]	[dm <sup>3</sup> ]	[W]	90/70/20°	75/65/20°	55/45/20°	
CEDRO	1600	560	50	1,2	34	6,1	300	756	<b>605</b>	324	<b>2840</b>

<b>PODŁĄCZENIA standardowe</b>  <i>cena zł netto:</i>	dolne v 50		<b>opcje</b>	kolor	dolne	krzyżowe	wodno-elekt.	elektryczne
	<b>ZAWORY dedykowane</b> <small>(nie są w komplecie z grzejnikiem)</small>  <i>cena zł netto:</i>	twins			<b>akcesoria</b>	 w cenie grzejnika		
				<b>relingi</b>				
				 <i>dopl. (str. 123-124)</i>				

# DIAMANTES

## GRZEJNIKI DEKORACYJNE

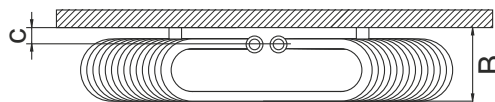
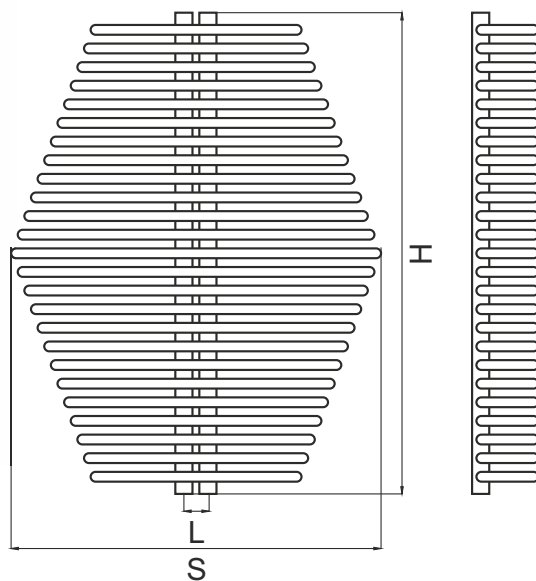

B = 180 ÷ 190 mm  
C = 55 ÷ 65 mm

DIAMANTES	H [mm]	S [mm]	L [mm]	Pow. [m <sup>2</sup> ]	Masa [kg]	Poj. [dm <sup>3</sup> ]	Moc grzałki [W]	Moc [W]			Cena [zł netto]
								90/70/20°	75/65/20°	55/45/20°	
DIAMANTES	980	790	50	1,36	14,0	9,3	600	990	<b>790</b>	430	1361

<b>PODŁĄCZENIA standardowe</b>  <i>cena zł netto:</i>	dolne v 50 	krzyżowe 		<b>opcje</b>	kolor w cenie grzejnika	wodno-elekt. 	elektryczne 	
	<b>ZAWORY dedykowane</b> (nie są w komplecie z grzejnikiem)  <i>cena zł netto:</i>	twins 615 zł	integra 622 zł			<b>akcesoria</b>	dopł.: + koszt grzałki (str. 118-119) + koszt napowienia wg wzoru: pojemn. x 35 zł katalogowo netto	

# CORNER ALFA

## GRZEJNIKI DEKORACYJNE

grzejniki narożnikowe zewnętrzne

CORNER ALFA 1

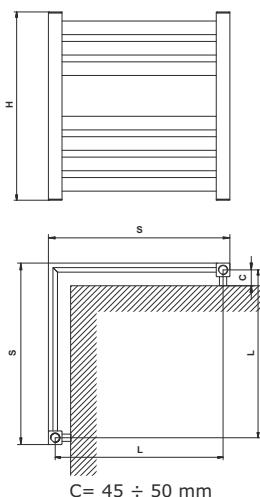

C = 45 ÷ 50 mm



CORNER ALFA 6

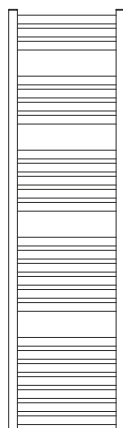

CORNER ALFA 5

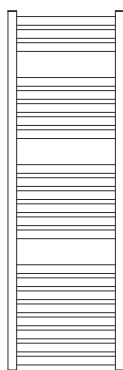

CORNER ALFA 4



CORNER ALFA 3

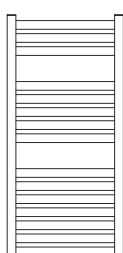

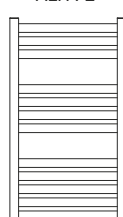

CORNER ALFA 2

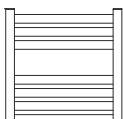

CORNER ALFA 1



CORNER ALFA	H [mm]	S [mm]	L [mm]	Pow. [m <sup>2</sup> ]	Masa [kg]	Poj. [dm <sup>3</sup> ]	Moc grzałki [W]	Moc [W]			Cena [zł netto]
								90/70/20°	75/65/20°	55/45/20°	
CORNER ALFA 1	415	400	370	0,45	5,6	1,5	200	343	<b>274</b>	145	<b>784</b>
CORNER ALFA 2	715	400	370	0,76	10,0	3,0	300	544	<b>435</b>	235	<b>1091</b>
CORNER ALFA 3	850	400	370	0,95	11,4	3,6	300	663	<b>530</b>	286	<b>1301</b>
CORNER ALFA 4	1060	400	370	1,13	14,7	4,2	600	774	<b>619</b>	335	<b>1455</b>
CORNER ALFA 5	1240	400	370	1,35	16,9	5,1	600	938	<b>750</b>	405	<b>1664</b>
CORNER ALFA 6	1450	400	370	1,55	18,9	6,0	800	1060	<b>848</b>	457	<b>1860</b>

<b>PODŁĄCZENIA standardowe</b> <i>cena zł netto:</i>	dolne	krzyżowe			<b>opcje</b> kolor  w cenie grzejnika	boczne	wodno-elekt.	elektryczne
	<b>ZAWORY dedykowane</b> <small>(nie są w komplecie z grzejnikiem)</small> <i>cena zł netto:</i>	swing	vision	integra		unico	 <i>dopt. 100 zł</i>	
					<b>akcesoria</b>			dopt.: + koszt grzałki (str. 118-119) + koszt napełnienia wg wzoru: pojemn. x 35 zł katalogowo netto

# CORNER BETA

## GRZEJNIKI DEKORACYJNE

grzejniki narożnikowe wewnętrzne



CORNER BETA 1

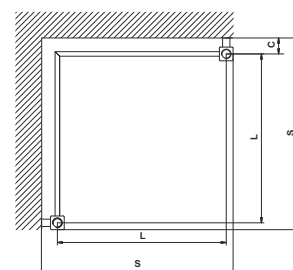
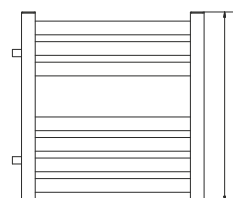

C = 45 ÷ 50 mm

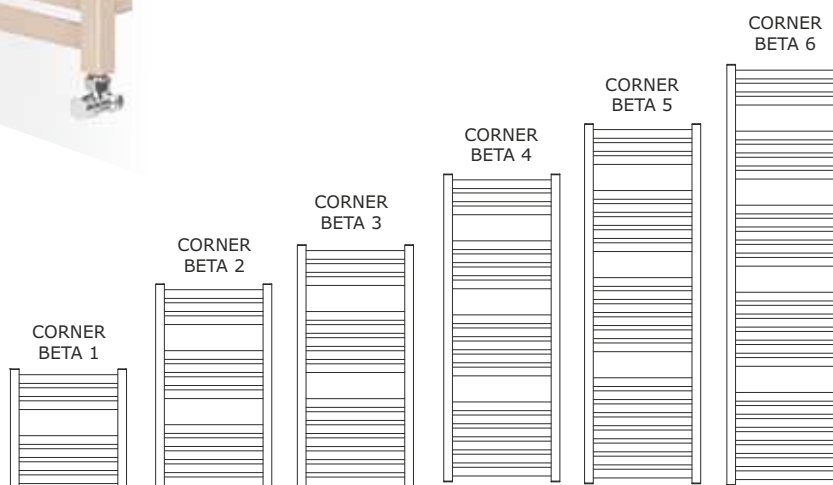

CORNER BETA	H [mm]	S [mm]	L [mm]	Pow. [m <sup>2</sup> ]	Masa [kg]	Poj. [dm <sup>3</sup> ]	Moc grzałki [W]	Moc [W]			Cena [zł netto]
								90/70/20°	75/65/20°	55/45/20°	
CORNER BETA 1	415	430	370	0,45	5,6	1,5	200	343	<b>274</b>	145	<b>784</b>
CORNER BETA 2	715	430	370	0,76	10,0	3,0	300	544	<b>435</b>	235	<b>1091</b>
CORNER BETA 3	850	430	370	0,95	11,4	3,6	300	663	<b>530</b>	286	<b>1301</b>
CORNER BETA 4	1060	430	370	1,13	14,7	4,2	600	774	<b>619</b>	335	<b>1455</b>
CORNER BETA 5	1240	430	370	1,35	16,9	5,1	600	938	<b>750</b>	405	<b>1664</b>
CORNER BETA 6	1450	430	370	1,55	18,9	6,0	800	1060	<b>848</b>	457	<b>1860</b>

<b>PODŁĄCZENIA standardowe</b> <i>cena zł netto:</i>	dolne	krzyżowe			<b>opcje</b>	kolor	boczne	wodno-elekt.	elektryczne
<b>ZAWORY dedykowane</b> <small>(nie są w komplecie z grzejnikiem)</small> <i>cena zł netto:</i>	swing	vision	integra	unico	<b>akcesoria</b>	<small>dopl.:</small> + koszt grzałki (str. 118-119) + koszt napełnienia wg wzoru: pojemn. x 35 zł katalogowo netto			

## STONE

## GRZEJNIKI DEKORACYJNE

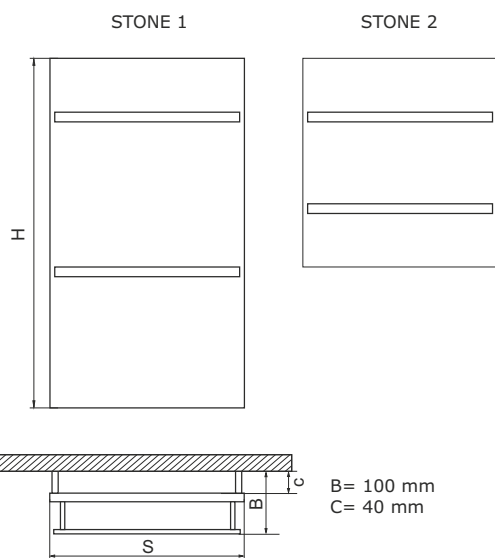

## WZORY KAMIENI

## MARMUR



1



2



3

## GRANIT



1



2



3



4



5

## TRAWERTYN



1



2



3

Kamień jest produktem naturalnym i charakteryzuje się niestabilnością zarówno w ubarwieniu jak i użyczeniu, dlatego nie ponosimy odpowiedzialności za zmienność produktu wynikającą z jego natury.

STONE	H [mm]	S [mm]	L [mm]	Masa [kg]	Moc grzałki [W]	Moc [W]			Cena [zł netto]
						90/70/20°	75/65/20°	55/45/20°	
STONE 1	900	500	50	55	300	375	<b>300</b>	160	<b>8691</b>
STONE 2	1500	500	50	71	300	500	<b>420</b>	230	<b>10320</b>

<b>PODŁĄCZENIA standardowe</b> <i>cena zł netto:</i>	dolne v 50	<b>opcje</b>	wzory kamieni	podłączenie pod grzałkę	wodno-elekt. 	elektryczne 
	<b>ZAWORY dedykowane</b> <small>(nie są w komplecie z grzejnikiem)</small> <i>cena zł netto:</i>		twins	<b>akcesoria</b>		

# WIKING

## GRZEJNIKI DEKORACYJNE

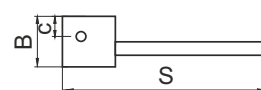
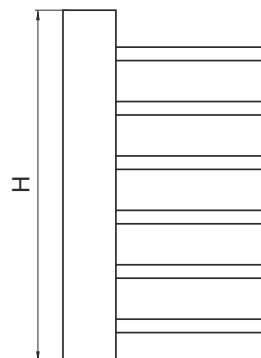

B = 140 mm  
C = 84 mm

### WZORY KAMIENI

GRANIT



1



2



3



4



5

Kamień jest produktem naturalnym i charakteryzuje się niestabilnością zarówno w ubarwieniu jak i użyciu, dlatego nie ponosimy odpowiedzialności za zmienność produktu wynikającą z jego natury.

WIKING	H [mm]	S [mm]	B [mm]	Masa [kg]	Moc grzałki [W]	Moc [W]			Cena [zł netto]
						90/70/20°	75/65/20°	55/45/20°	
WIKING	950	500	140	30	200	250	<b>200</b>	110	<b>10140</b>

<b>PODŁĄCZENIA standardowe</b> <i>cena zł netto:</i>	dolne		<b>opcje</b>	wzory kamieni	podłączenie pod grzałkę	wodno-elekt.	elektryczne
	<i>cena zł netto:</i>			<b>dopl. 100 zł</b>			
<b>ZAWORY dedykowane</b> (nie są w komplecie z grzejnikiem) <i>cena zł netto:</i>	unico		<b>akcesoria</b>	grzałki elektr.			
	<i>cena zł netto:</i>			<b>592 zł</b>		dopl.: + koszt grzałki (str. 118-119) + koszt napełnienia wg wzoru: pojemn. x 35 zł katalogowo netto	

## AUTO

## GRZEJNIKI DEKORACYJNE

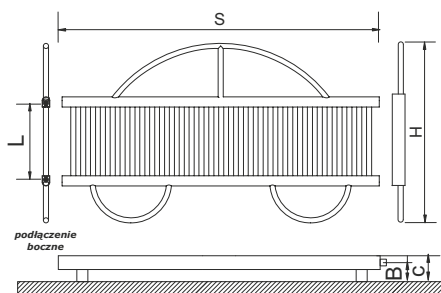
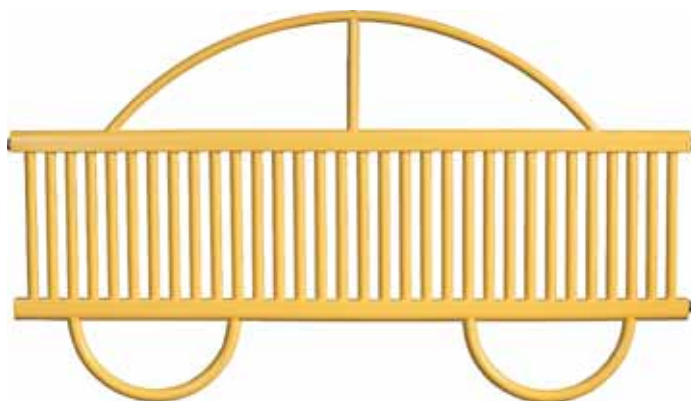

B= 160 ÷ 170 mm  
C= 50 ÷ 65 mm

AUTO	H [mm]	S [mm]	L [mm]	Pow. [m <sup>2</sup> ]	Masa [kg]	Poj. [dm <sup>3</sup> ]	Moc grzałki [W]	Moc [W]			Cena [zł netto]
								90/70/20°	75/65/20°	55/45/20°	
AUTO	680	1250	300	0,45	15	3,2	---	560	<b>450</b>	240	1739

<b>PODŁĄCZENIA standardowe</b> <i>cena zł netto:</i>	boczne	krzyżowe		<b>opcje</b> KOLOR  w cenie grzejnika
	<b>ZAWORY dedykowane</b> (nie są w komplecie z grzejnikiem) <i>cena zł netto:</i>	swing	vision	

**CASA**  
**GRZEJNIKI DEKORACYJNE**

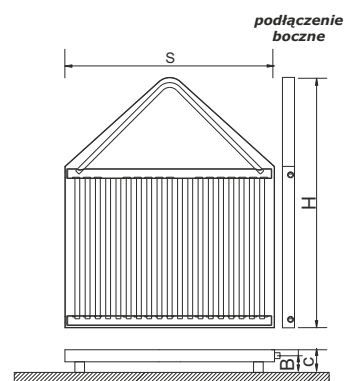

B = 160 ÷ 170 mm  
C = 50 ÷ 65 mm

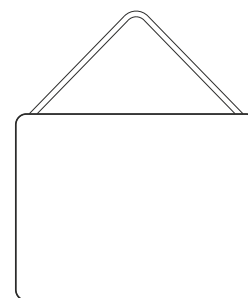

CASA	H	S	L	Pow.	Masa	Poj.	Moc grzałki	Moc [W]			Cena [zł netto]
	[mm]	[mm]	[mm]	[m <sup>2</sup> ]	[kg]	[dm <sup>3</sup> ]	[W]	90/70/20°	75/65/20°	55/45/20°	
CASA	1030	900	50	0,9	15	4,3	---	630	<b>505</b>	270	<b>1450</b>

<b>PODŁĄCZENIA standardowe</b> <i>cena zł netto:</i>	boczne	krzyżowe		<b>opcje</b> KOLOR  w cenie grzejnika
	<b>ZAWORY dedykowane</b> (nie są w komplecie z grzejnikiem) <i>cena zł netto:</i>	swing	vision	
				
	<b>267 zł</b>	<b>450 zł</b>		

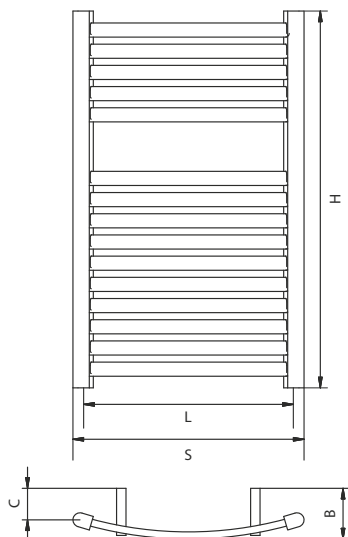
**PEDRO T CR****GRZEJNIKI DEKORACYJNE**

B = 90 ÷ 100 mm  
C = 70 ÷ 80 mm

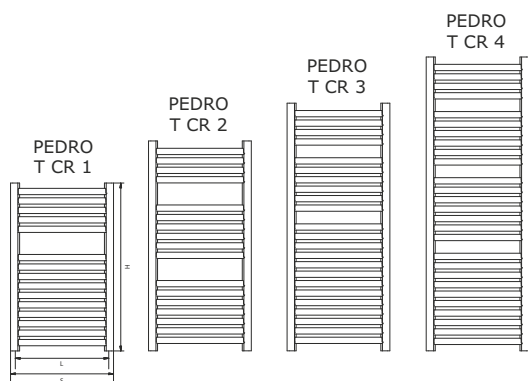

PEDRO T CR	H [mm]	S [mm]	L [mm]	Pow. [m <sup>2</sup> ]	Masa [kg]	Poj. [dm <sup>3</sup> ]	Moc grzałki [W]	Moc [W]			Cena [zł netto]
								90/70/20°	75/65/20°	55/45/20°	
PEDRO 1 T CR	800	500	450	0,7	7,8	3,4	200	282	<b>225</b>	122	<b>1122</b>
PEDRO 2 T CR	1000	500	450	0,8	9,8	4,3	200	331	<b>265</b>	143	<b>1257</b>
PEDRO 3 T CR	1180	500	450	1,1	11,7	5,10	300	423	<b>338</b>	183	<b>1520</b>
PEDRO 4 T CR	1400	500	450	1,2	13,2	5,8	300	478	<b>382</b>	206	<b>1759</b>

<b>PODŁĄCZENIA standardowe</b> <i>cena zł netto:</i>	dolne	krzyżowe			<b>opcje</b>	wodno-elekt.	elektryczne		
<b>ZAWORY dedykowane</b> <small>(nie są w komplecie z grzejnikiem)</small> <i>cena zł netto:</i>	swing	vision	integra	unico	<b>akcesoria</b>	dopl.: + koszt grzałki (str. 118-119) + koszt napełnienia wg wzoru: pojemn. x 35 zł katalogowo netto			

# LIVIA T CR

## GRZEJNIKI DEKORACYJNE

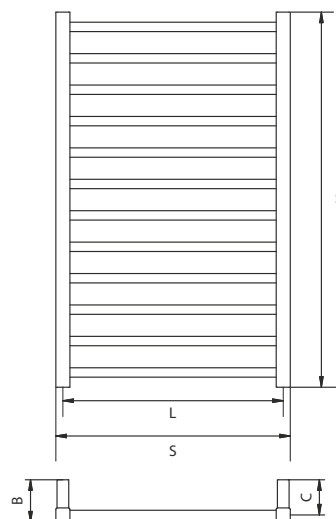

B= 83 ÷ 98 mm  
C= 68 ÷ 83 mm

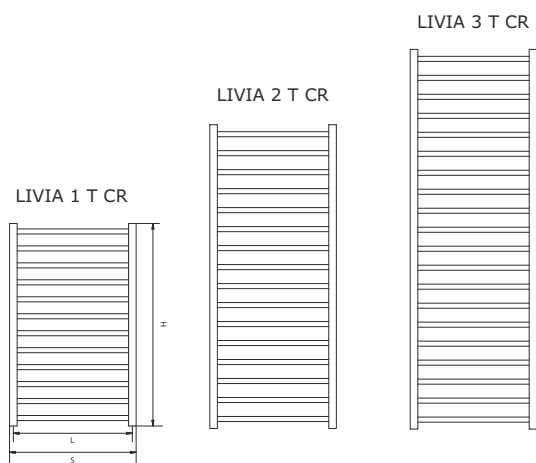

LIVIA T CR	H [mm]	S [mm]	L [mm]	Pow. [m <sup>2</sup> ]	Masa [kg]	Poj. [dm <sup>3</sup> ]	Moc grzałki [W]	Moc [W]			Cena [zł netto]
								90/70/20°	75/65/20°	55/45/20°	
LIVIA 1 T CR	800	500	470	0,43	5,3	1,6	200	228	<b>182</b>	97	1379
LIVIA 2 T CR	1200	500	470	0,6	7,5	2,4	200	317	<b>254</b>	138	1598
LIVIA 3 T CR	1500	500	470	0,75	9,2	3,0	300	400	<b>320</b>	173	2042

<b>PODŁĄCZENIA standardowe</b> <i>cena zł netto:</i>	dolne	krzyżowe			<b>opcje</b>	wodno-elekt.	elektryczne	
<b>ZAWORY dedykowane</b> <small>(nie są w komplecie z grzejnikiem)</small> <i>cena zł netto:</i>	swing	vision	integra	unico	<b>akcesoria</b>	wieszak WLK 30	dopl.: + koszt grzałki (str. 118-119) + koszt napełnienia wg wzoru: pojemn. x 35 zł katalogowo netto	
							<b>dopl. 47 zł</b>	

# ADAMO T CR

## GRZEJNIKI DEKORACYJNE

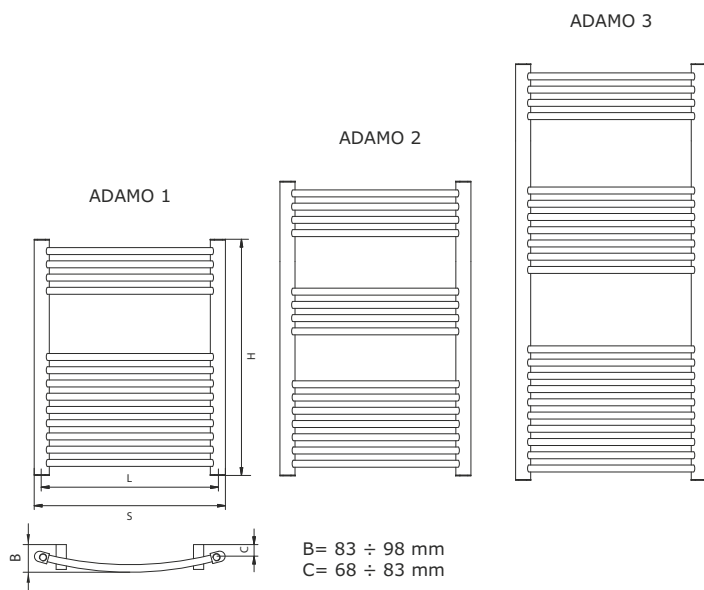

ADAMO T CR	H [mm]	S [mm]	L [mm]	Pow. [m <sup>2</sup> ]	Masa [kg]	Poj. [dm <sup>3</sup> ]	Moc grzałki [W]	Moc [W]			Cena [zł netto]
								90/70/20°	75/65/20°	55/45/20°	
ADAMO 1 T CR	700	500	450	0,55	5,9	3,0	200	281	<b>225</b>	122	<b>524</b>
ADAMO 2 T CR	900	500	450	0,65	7,0	3,7	200	331	<b>265</b>	141	<b>620</b>
ADAMO 3 T CR	1200	500	450	0,90	9,2	5,0	300	422	<b>338</b>	183	<b>809</b>

<b>PODŁĄCZENIA standardowe</b> <i>cena zł netto:</i>	dolne 	krzyżowe 			<b>opcje</b>	wodno-elekt. 	elektryczne 		
	<b>ZAWORY dedykowane</b> <small>(nie są w komplecie z grzejnikiem)</small> <i>cena zł netto:</i>	swing  <b>267 zł</b>	vision  <b>450 zł</b>	integra  <b>578 zł</b>		unico  <b>592 zł</b>	<b>akcesoria</b>	dopl.: + koszt grzałki (str. 118-119) + koszt napełnienia wg wzoru: pojemn. x 35 zł katalogowo netto	

# ADAMO GOLD

## GRZEJNIKI DEKORACYJNE

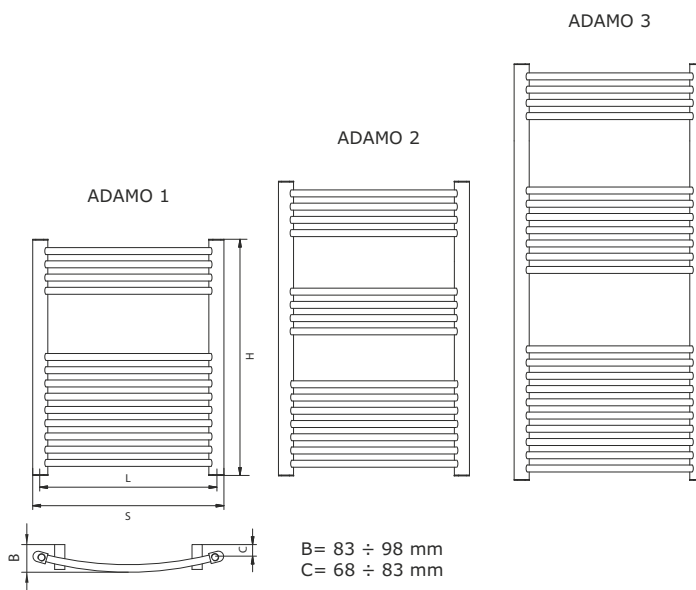

ADAMO GOLD	H [mm]	S [mm]	L [mm]	Pow. [m <sup>2</sup> ]	Masa [kg]	Poj. [dm <sup>3</sup> ]	Moc grzałki [W]	Moc [W]			Cena [zł netto]
								90/70/20°	75/65/20°	55/45/20°	
ADAMO GOLD 1	700	500	450	0,55	5,9	3,0	200	281	<b>225</b>	122	2130
ADAMO GOLD 2	900	500	450	0,65	7,0	3,7	200	331	<b>265</b>	141	2280
ADAMO GOLD 3	1200	500	450	0,90	9,2	5,0	300	422	<b>338</b>	183	2450

<b>PODŁĄCZENIA standardowe</b> <i>cena zł netto:</i>	dolne	krzyżowe		<b>opcje</b>	wodno-elekt.	elektryczne	
<b>ZAWORY dedykowane</b> <small>(nie są w komplecie z grzejnikiem)</small> <i>cena zł netto:</i>	vision	emas		<b>akcesoria</b>	grzałki elektr.	dopl.: + koszt grzałki (str. 118-119) + koszt napełnienia wg wzoru: pojemn. x 35 zł katalogowo netto	
	<i>757 zł</i>	<i>490 zł</i>			(str. 118-119)		

## FRAGIL

## GRZEJNIKI DEKORACYJNE

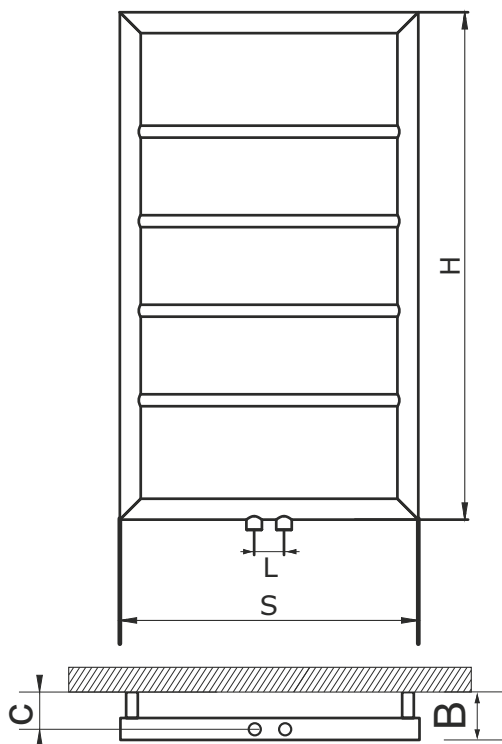

B= 90 mm  
C= 75 mm



FRAGIL	H [mm]	S [mm]	L [mm]	Pow. [m <sup>2</sup> ]	Masa [kg]	Poj. [dm <sup>3</sup> ]	Moc grzałki [W]	Moc [W]			Cena [zł netto]
								90/70/20°	75/65/20°	55/45/20°	
FRAGIL CHROM	850	435	50	0,35	6,0	2,2	200	220	<b>175</b>	95	<b>2159</b>
FRAGIL KOLOR	850	435	50	0,35	6,0	2,2	200	260	<b>210</b>	110	<b>1224</b>

<b>PODŁĄCZENIA standardowe</b> <i>cena zł netto:</i>	dolne v 50		<b>opcje</b>	kolor	wodno-elekt.	elektryczne
				 w cenie grzejnika		
<b>ZAWORY dedykowane</b> <small>(nie są w komplecie z grzejnikiem)</small> <i>cena zł netto:</i>	twins	twins	<b>akcesoria</b>	grzałki elektr.	dopł.: + koszt grzałki (str. 118-119) + koszt napełnienia wg wzoru: pojemn. x 35 zł katalogowo netto	
	 <b>615 zł</b>	 <b>578 zł</b>		 (str. 118-119)		

# ESFERA

## GRZEJNIKI DEKORACYJNE

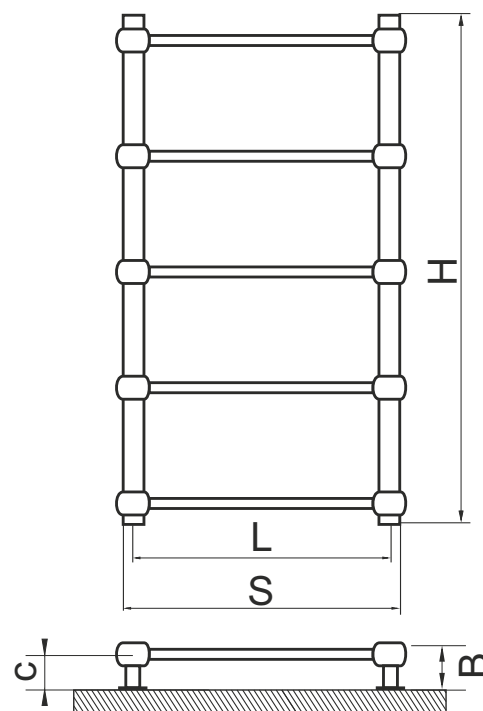

B= 110 mm  
C= 85 mm

ESFERA	H [mm]	S [mm]	L [mm]	Pow. [m <sup>2</sup> ]	Masa [kg]	Poj. [dm <sup>3</sup> ]	Moc grzałki [W]	Moc [W]			Cena [zł netto]
								90/70/20°	75/65/20°	55/45/20°	
ESFERA CHROM	905	550	500	0,34	6,5	2,2	200	220	<b>175</b>	95	<b>2579</b>
ESFERA KOLOR	905	550	500	0,34	6,5	2,2	200	260	<b>210</b>	110	<b>1527</b>

<b>PODŁĄCZENIA standardowe</b> <i>cena zł netto:</i>	dolne		<b>opcje</b>	kolor	wodno-elekt.	elektryczne	<b>akcesoria</b>
		 KOLOR w cenie grzejnika			 dopł.: + koszt grzałki (str. 118-119) + koszt napełnienia wg wzoru: pojemn. x 35 zł katalogowo netto		
<b>ZAWORY dedykowane</b> (nie są w komplecie z grzejnikiem) <i>cena zł netto:</i>	vision  <b>450 zł</b>						

# RETRO

## GRZEJNIKI DEKORACYJNE

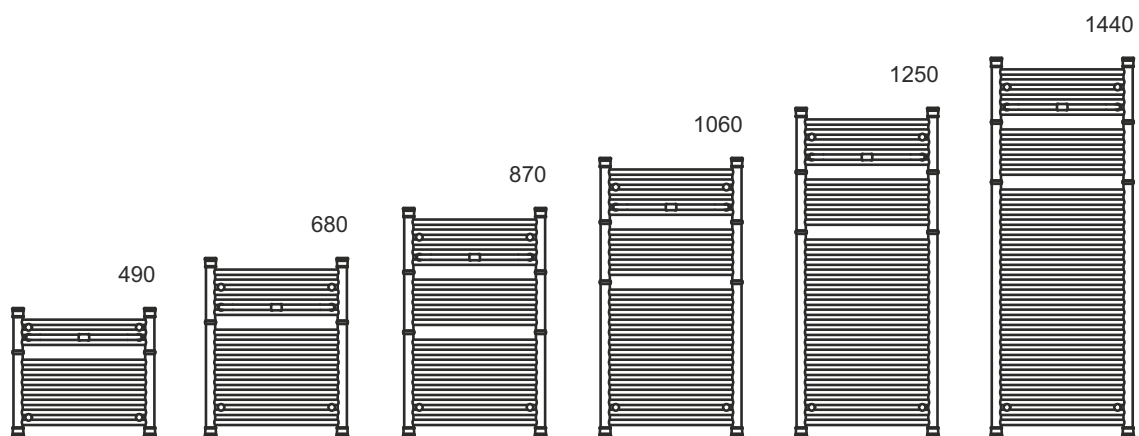

# RETRO

## GRZEJNIKI DEKORACYJNE

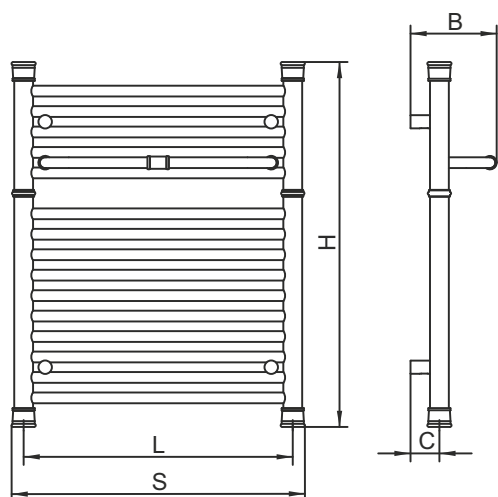

B= 160 ÷ 170 mm  
C= 55 ÷ 65 mm

RETRO	H [mm]	S [mm]	L [mm]	Pow. [m <sup>2</sup> ]	Masa [kg]	Poj. [dm <sup>3</sup> ]	Moc grzałki [W]	Moc [W]			Cena [zł netto]
								90/70/20°	75/65/20°	55/45/20°	
RETRO A1-400/P/KOLOR	490	445	400	0,33	4,4	1,6	200	290	<b>230</b>	124	791
RETRO A2-400/P/KOLOR	680	445	400	0,46	5,2	2,2	200	390	<b>310</b>	165	1053
RETRO A3-400/P/KOLOR	870	445	400	0,57	6,7	3,0	300	480	<b>380</b>	205	1193
RETRO A4-400/P/KOLOR	1060	445	400	0,74	8,2	3,7	300	570	<b>460</b>	248	1324
RETRO A5-400/P/KOLOR	1250	445	400	0,89	9,9	4,5	300	680	<b>540</b>	291	1492
RETRO A6-400/P/KOLOR	1440	445	400	1,02	10,5	5,4	600	790	<b>630</b>	340	1669
RETRO A1-500/P/KOLOR	490	545	500	0,42	4,9	1,9	200	320	<b>255</b>	136	842
RETRO A2-500/P/KOLOR	680	545	500	0,60	5,9	2,6	300	450	<b>360</b>	194	1107
RETRO A3-500/P/KOLOR	870	545	500	0,75	7,7	3,5	300	570	<b>460</b>	245	1304
RETRO A4-500/P/KOLOR	1060	545	500	0,93	9,4	4,4	300	680	<b>545</b>	292	1398
RETRO A5-500/P/KOLOR	1250	545	500	1,12	11,2	5,2	600	830	<b>665</b>	357	1612
RETRO A6-500/P/KOLOR	1440	545	500	1,30	12,2	5,8	600	960	<b>770</b>	415	1780
RETRO A1-600/P/KOLOR	490	645	600	0,51	5,5	2,4	200	350	<b>280</b>	150	987
RETRO A2-600/P/KOLOR	680	645	600	0,75	7,1	3,3	300	520	<b>415</b>	222	1286
RETRO A3-600/P/KOLOR	870	645	600	0,94	9,5	4,4	300	670	<b>535</b>	288	1519
RETRO A4-600/P/KOLOR	1060	645	600	1,12	10,8	5,6	600	790	<b>630</b>	340	1669
RETRO A5-600/P/KOLOR	1250	645	600	1,35	13,2	6,7	600	970	<b>775</b>	418	1761
RETRO A6-600/P/KOLOR	1440	645	600	1,60	16,2	7,7	600	1130	<b>905</b>	486	1939
RETRO A1-400/P/CHROM	490	445	400	0,33	4,4	1,6	---	220	<b>175</b>	95	1536
RETRO A2-400/P/CHROM	680	445	400	0,46	5,2	2,2	200	290	<b>230</b>	125	1969
RETRO A3-400/P/CHROM	870	445	400	0,57	6,7	3,0	200	360	<b>290</b>	155	2387
RETRO A4-400/P/CHROM	1060	445	400	0,74	8,2	3,7	300	430	<b>345</b>	185	2775
RETRO A5-400/P/CHROM	1250	445	400	0,89	9,9	4,5	300	510	<b>410</b>	220	3229
RETRO A6-400/P/CHROM	1440	445	400	1,02	10,5	5,4	300	590	<b>470</b>	253	3628
RETRO A1-500/P/CHROM	490	545	500	0,42	4,9	1,9	---	240	<b>190</b>	102	1673
RETRO A2-500/P/CHROM	680	545	500	0,60	5,9	2,6	200	340	<b>270</b>	143	2173
RETRO A3-500/P/CHROM	870	545	500	0,75	7,7	3,5	300	430	<b>345</b>	185	2659
RETRO A4-500/P/CHROM	1060	545	500	0,93	9,4	4,4	300	510	<b>410</b>	220	3109
RETRO A5-500/P/CHROM	1250	545	500	1,12	11,2	5,2	300	620	<b>500</b>	270	3628
RETRO A6-500/P/CHROM	1440	545	500	1,30	12,2	5,8	300	720	<b>575</b>	310	4099
RETRO A1-600/P/CHROM	490	645	600	0,51	5,5	2,4	200	265	<b>210</b>	113	2373
RETRO A2-600/P/CHROM	680	645	600	0,75	7,1	3,3	300	390	<b>310</b>	165	2495
RETRO A3-600/P/CHROM	870	645	600	0,94	9,5	4,4	300	500	<b>400</b>	215	3065
RETRO A4-600/P/CHROM	1060	645	600	1,12	10,8	5,6	300	590	<b>470</b>	250	3518
RETRO A5-600/P/CHROM	1250	645	600	1,35	13,2	6,7	300	730	<b>585</b>	315	4122
RETRO A6-600/P/CHROM	1440	645	600	1,60	16,2	7,7	600	850	<b>680</b>	365	4738

<b>PODŁĄCZENIA standardowe</b> cena zł netto:	dolne 	krzyżowe 			opcje cena zł netto:	kolor 	wodno-elekt. 	elektryczne 	
	w cenie grzejnika								
<b>ZAWORY dedykowane</b> (nie są w komplecie z grzejnikiem) cena zł netto:	swing  267 zł	vision  450 zł	integra  622 zł	unico  627 zł	akcesoria cena zł netto:	dopl.: + koszt grzałki (str. 118-119) + koszt napełnienia wg wzoru: pojemn. x 35 zł katalogowo netto			

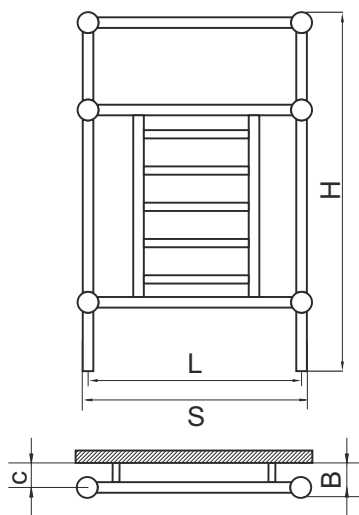
**CLARO****GRZEJNIKI DEKORACYJNE**

B= 110 mm  
C= 85 mm



CLARO	H [mm]	S [mm]	L [mm]	Pow. [m <sup>2</sup> ]	Masa [kg]	Poj. [dm <sup>3</sup> ]	Moc grzałki [W]	Moc [W]			Cena [zł netto]
								90/70/20°	75/65/20°	55/45/20°	
CLARO KOLOR	860	550	500	0,42	7,5	2,2	200	320	<b>255</b>	140	<b>2041</b>
CLARO CHROM	860	550	500	0,42	7,5	2,2	200	270	<b>215</b>	120	<b>2929</b>

<b>PODŁĄCZENIA standardowe</b> <i>cena zł netto:</i>	dolne				<b>opcje</b>	kolor	wodno-elekt.	elektryczne	
						w cenie grzejnika	dopł.: + koszt grzałki (str. 118-119) + koszt napełnienia wg wzoru: pojemn. x 35 zł katalogowo netto		
<b>ZAWORY dedykowane</b> (nie są w komplecie z grzejnikiem) <i>cena zł netto:</i>	swing	vision	integra	unico	<b>akcesoria</b>				
	<b>267 zł</b>	<b>450 zł</b>	<b>622 zł</b>	<b>627 zł</b>					

grzejniki  
płytkowe



<b>KOSZT DOSTAWY GRZEJNIKÓW</b>			
<b>do 1800 mm długości</b>		<b>powyżej 1800 mm długości</b>	
wartość faktury netto zł	koszt dostawy zł netto	wartość faktury netto zł	koszt dostawy zł netto
do 1500	100	do 3000	300
1500- 2500	50	3000 - 5000	200
pow. 2500	0	5 000 - 7000	100
		pow. 7 000	0

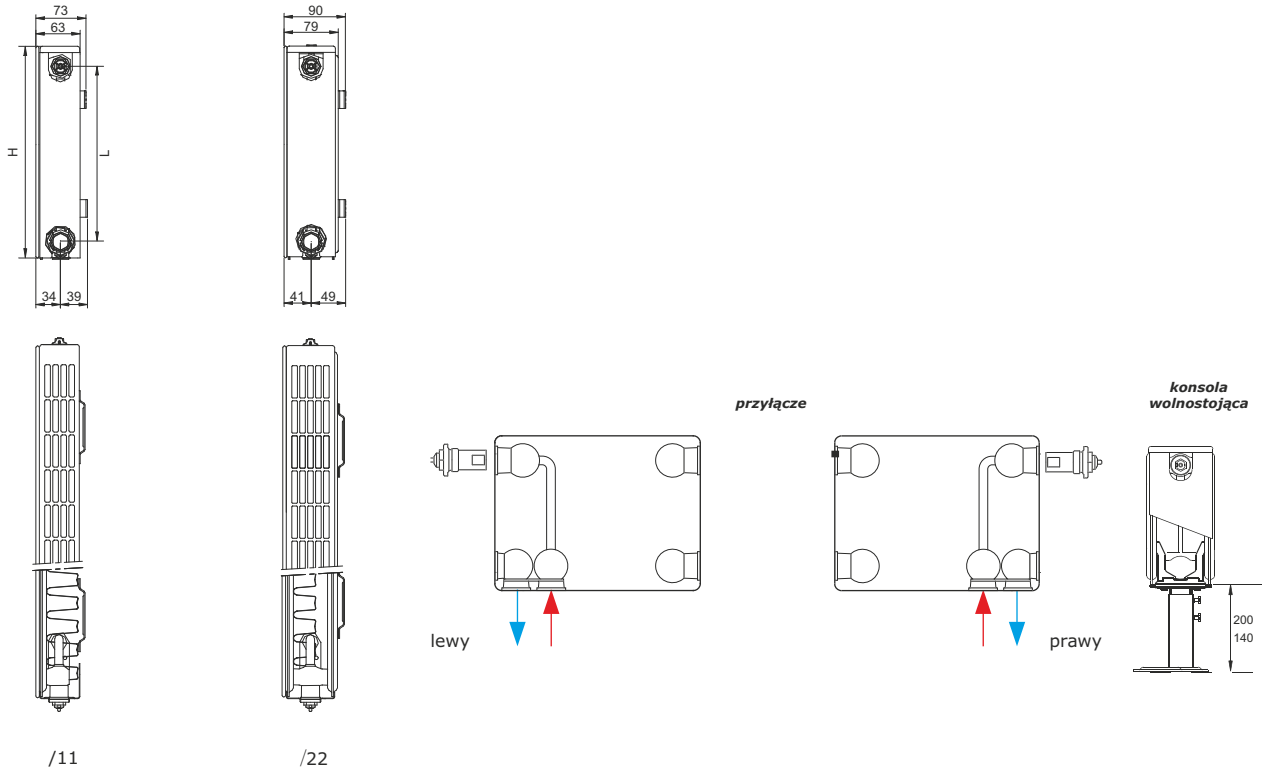

POINT P	H [mm]	S [mm]	L [mm]	Masa [kg]	Moc [W]			Cena [zł netto]
					90/70/20°	75/65/20°	55/45/20°	
POINT P 500 3/22 (22/50/60)	500	600	450	20	1058	<b>847</b>	433	<b>1462</b>
POINT P 500 5/22 (22/50/80)	500	800	450	26,5	1411	<b>1129</b>	577	<b>1658</b>
POINT P 500 7/22 (22/50/100)	500	1000	450	33,2	1763	<b>1411</b>	722	<b>1873</b>
POINT P 500 9/22 (22/50/120)	500	1200	450	40	2116	<b>1693</b>	866	<b>2141</b>
POINT P 500 11/22 (22/50/160)	500	1600	450	53,2	2822	<b>2258</b>	1155	<b>2671</b>
*) POINT P 500 13/22 (22/50/200)	500	2000	450	66,5	3527	<b>2822</b>	1444	<b>3184</b>
POINT P 600 1/22 (22/60/40)	600	400	550	16	806	<b>654</b>	333	<b>1331</b>
POINT P 600 2/22 (22/60/50)	600	500	550	20	1021	<b>817</b>	416	<b>1421</b>
POINT P 600 3/22 (22/60/60)	600	600	550	24	1225	<b>980</b>	499	<b>1498</b>
POINT P 600 4/22 (22/60/70)	600	700	550	28	1430	<b>1144</b>	583	<b>1642</b>
POINT P 600 5/22 (22/60/80)	600	800	550	32	1633	<b>1307</b>	666	<b>1725</b>
POINT P 600 6/22 (22/60/90)	600	900	550	36	1838	<b>1471</b>	749	<b>1873</b>
POINT P 600 7/22 (22/60/100)	600	1000	550	40	2042	<b>1634</b>	832	<b>1969</b>
POINT P 600 8/22 (22/60/110)	600	1100	550	44	2246	<b>1797</b>	916	<b>2145</b>
POINT P 600 9/22 (22/60/120)	600	1200	550	48	2451	<b>1961</b>	999	<b>2238</b>
POINT P 600 10/22 (22/60/140)	600	1400	550	56	2860	<b>2288</b>	1165	<b>2610</b>
POINT P 600 11/22 (22/60/160)	600	1600	550	64	3267	<b>2614</b>	1332	<b>2960</b>
POINT P 600 12/22 (22/60/180)	600	1800	550	72	3676	<b>2941</b>	1498	<b>3296</b>
*) POINT P 600 13/22 (22/60/200)	600	2000	550	80	4085	<b>3268</b>	1665	<b>3614</b>
*) POINT P 600 14/22 (22/60/220)	600	2200	550	88	4493	<b>3595</b>	1831	<b>3696</b>

\*) Grzejnik dostępny tylko w kolorze białym.

Przy zamówieniu proszę podać formę podłączenia dolnego: skrajne lewe, skrajne prawe, boczne prawe, boczne lewe.

Grzejniki o szerokości od 400mm do 1400mm dodatkowo mogą posiadać 2 konsole wolnostojące; powyżej 1400mm - 3 konsole wolnostojące.

<b>PODŁĄCZENIA standardowe</b> cena zł netto: pod zamówienie	dolne v 50	opcje	kolor +25%	boczne	boczne	konsola wolnostojąca	możliwość zamówienia innych wymiarów czas realizacji 3-4 miesiące
	ZAWORY dedykowane (nie są w komplecie z grzejnikiem) cena zł netto:		premium exclusive	KOLOR dopł. 25 %	pod zamówienie	pod zamówienie	
	378 zł	akcesoria					



**KOSZT DOSTAWY GRZEJNIKÓW**

do 1800 mm długości		powyżej 1800 mm długości	
wartość faktury netto zł	koszt dostawy zł netto	wartość faktury netto zł	koszt dostawy zł netto
do 1500	100	do 3000	300
1500- 2500	50	3000 - 5000	200
pow. 2500	0	5 000 - 7000	100
		pow. 7 000	0

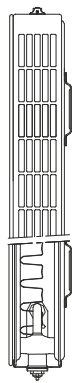
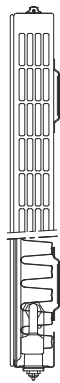
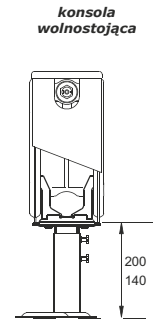
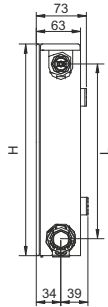

/11

/22

przyłącze lewe

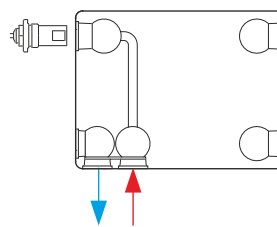

przyłącze prawe

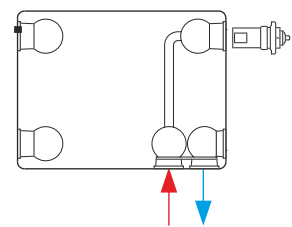

POINT S	H [mm]	S [mm]	L [mm]	Masa [kg]	Moc [W]			Cena [zł netto]	
					90/70/20°	75/65/20°	55/45/20°		
POINT S 500 1/22	22/50/50	500	500	450	16,6	881	<b>694</b>	356	1479
POINT S 500 2/22	22/50/60	500	600	450	20	1057	<b>833</b>	427	1589
POINT S 500 4/22	22/50/80	500	800	450	26,5	1410	<b>1110</b>	569	1796
POINT S 500 6/22	22/50/100	500	1000	450	33,2	1762	<b>1388</b>	711	2038
POINT S 500 7/22	22/50/120	500	1200	450	40	2114	<b>1666</b>	854	2326
POINT S 600 1/22	22/60/50	600	500	550	20	1017	<b>801</b>	409	1543
POINT S 600 2/22	22/60/60	600	600	550	24	1221	<b>961</b>	491	1626
POINT S 600 3/22	22/60/70	600	700	550	28	1424	<b>1121</b>	573	1778
POINT S 600 4/22	22/60/80	600	800	550	32	1628	<b>1281</b>	655	1873
POINT S 600 5/22	22/60/90	600	900	550	36	1831	<b>1441</b>	736	2038
POINT S 600 6/22	22/60/100	600	1000	550	40	2034	<b>1601</b>	818	2137
POINT S 600 7/22	22/60/120	600	1200	550	48	2441	<b>1921</b>	982	2429
POINT S 600 8/22	22/60/140	600	1400	550	56	2848	<b>2241</b>	1145	2833
POINT S 600 9/22	22/60/160	600	1600	550	64	3255	<b>2562</b>	1309	3211
POINT S 600 10/22	22/60/180	600	1800	550	72	3662	<b>2882</b>	1473	3568

Przy zamówieniu proszę podać formę podłączenia dolnego: skrajne lewe, skrajne prawe, boczne prawe, boczne lewe.

Grzejniki o szerokości od 400mm do 1400mm dodatkowo mogą posiadać 2 konsole wolnostojące; powyżej 1400mm - 3 konsole wolnostojące.

<b>PODŁĄCZENIA standardowe</b> cena zł netto: pod zamówienie	dolne v 50	<b>opcje</b>	kolor +25% KOLOR dopł. 25 %	boczne pod zamówienie	boczne pod zamówienie	konsola wolnostojąca dopł. 150 zł szt	możliwość zamówienia innych wymiarów pod zamówienie czas realizacji 3-4 miesiące
	<b>ZAWORY dedykowane</b> (nie są w komplecie z grzejnikiem) cena zł netto:		premium exclusive 378 zł	<b>akcesoria</b>			



### KOSZT DOSTAWY GRZEJNIKÓW

do 1800 mm długości		powyżej 1800 mm długości	
wartość faktury netto zł	koszt dostawy zł netto	wartość faktury netto zł	koszt dostawy zł netto
do 1500	100	do 3000	300
1500- 2500	50	3000 - 5000	200
pow. 2500	0	5 000 - 7000	100
		pow. 7 000	0

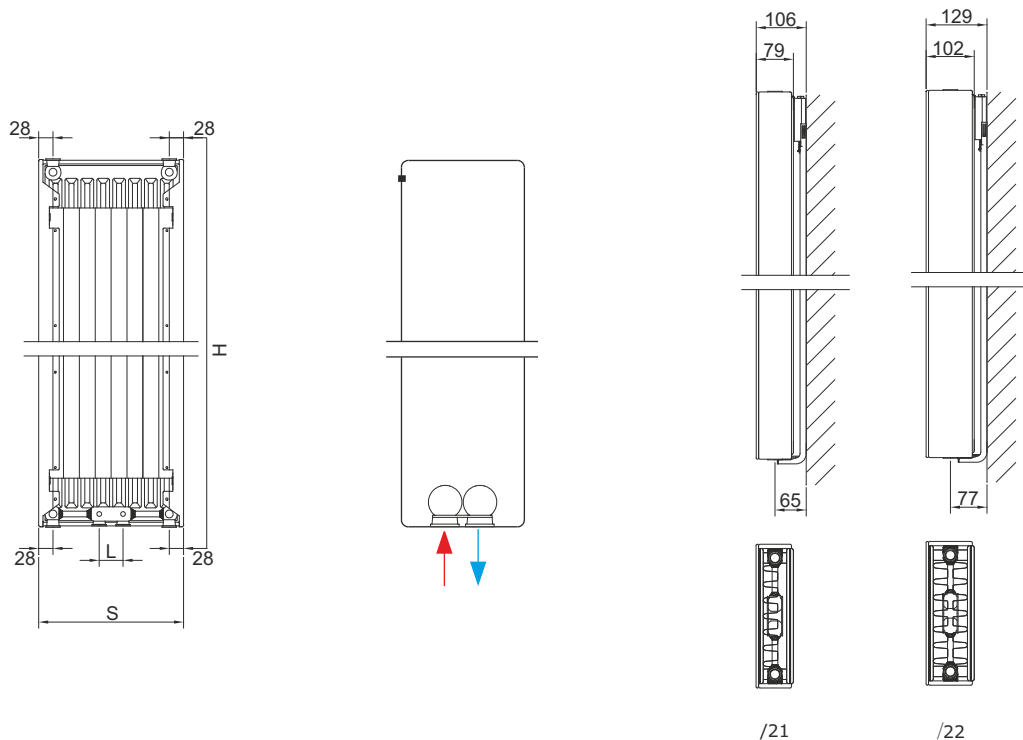

VENEZIA P	H [mm]	S [mm]	L [mm]	Pow. [m <sup>2</sup> ]	Masa [kg]	Poj. [dm <sup>3</sup> ]	Moc [W]			Cena [zł netto]
							90/70/20°	75/65/20°	55/45/20°	
VENEZIA P 1600 1/22 22/160/30	1600	300	50	8,69	28,3	4,23	1282	<b>1026</b>	522	2924
VENEZIA P 1600 2/22 22/160/40	1600	400	50	11,6	37,7	5,64	1710	<b>1368</b>	696	3337
VENEZIA P 1600 3/22 22/160/50	1600	500	50	14,5	47,1	7,05	2137	<b>1710</b>	870	3772
VENEZIA P 1600 4/22 22/160/60	1600	600	50	17,39	56,5	8,46	2565	<b>2052</b>	1044	4187
VENEZIA P 1800 2/21 21/180/40	1800	400	50	5,43	38,4	6,36	1553	<b>1224</b>	629	2859
VENEZIA P 1800 3/21 21/180/50	1800	500	50	6,79	48	7,95	1912	<b>1530</b>	786	3244
VENEZIA P 1800 4/21 21/180/60	1800	600	50	8,15	57,6	9,54	2295	<b>1836</b>	943	3655
VENEZIA P 1800 1/22 22/180/30	1800	300	50	8,97	31,6	4,77	1387	<b>1107</b>	563	3148
VENEZIA P 1800 2/22 22/180/40	1800	400	50	11,96	42,12	6,36	1845	<b>1476</b>	750	3600
VENEZIA P 1800 3/22 22/180/50	1800	500	50	14,95	52,7	7,95	2306	<b>1845</b>	938	4078
VENEZIA P 1800 4/22 22/180/60	1800	600	50	17,94	63,2	9,54	2767	<b>2214</b>	1125	4538
VENEZIA P 1800 5/22 22/180/70	1800	700	50	20,93	73,7	11,13	3228	<b>2583</b>	1313	5058
*) VENEZIA P 2000 3/22 22/200/50	2000	500	50	18,87	58,2	8,85	2475	<b>1980</b>	1005	4228
*) VENEZIA P 2000 4/22 22/200/60	2000	600	50	22,64	69,8	10,62	2970	<b>2376</b>	1206	4699
*) VENEZIA P 2000 5/22 22/200/70	2000	700	50	26,42	81,5	12,39	3465	<b>2772</b>	1407	5261
*) VENEZIA P 2200 1/22 22/220/30	2200	300	50	11	38	6,03	1586	<b>1269</b>	634	3412
*) VENEZIA P 2200 2/22 22/220/40	2200	400	50	14,66	50,6	8,06	2115	<b>1692</b>	858	3925
*) VENEZIA P 2200 3/22 22/220/50	2200	500	50	18,33	63,3	10	2643	<b>2115</b>	1072	4457
*) VENEZIA P 2200 4/22 22/220/60	2200	600	50	22	76	12,06	3172	<b>2538</b>	1286	4973
*) VENEZIA P 2200 5/22 22/220/70	2200	700	50	25,66	88,6	14,07	3701	<b>2961</b>	1501	5565

\*) Grzejnik dostępny tylko w kolorze białym.

W grzejniku zasilanie **ZAWSZE** z lewej strony.

<b>PODŁĄCZENIA standardowe</b> <i>cena zł netto:</i>	dolne v 50 		<b>opcje</b>	kolor KOLOR +25%  dopł. 25 %	możliwość zamówienia innych wymiarów pod zamówienie czas realizacji 3-4 miesiące	
<b>ZAWORY dedykowane</b> <small>(nie są w komplecie z grzejnikiem)</small> <i>cena zł netto:</i>	twins 	<b>578 zł</b>	<b>akcesoria</b>			

# 78 VENEZIA S

## GRZEJNIKI PŁYTOWE

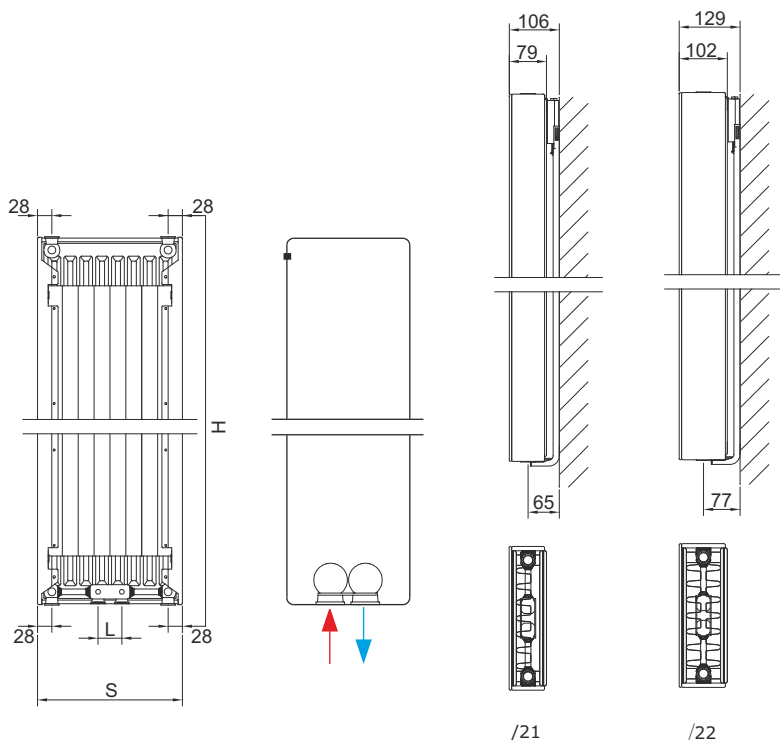

### KOSZT DOSTAWY GRZEJNIKÓW

do 1800 mm długości		powyżej 1800 mm długości	
wartość faktury netto zł	koszt dostawy zł netto	wartość faktury netto zł	koszt dostawy zł netto
do 1500	100	do 3000	300
1500- 2500	50	3000 - 5000	200
pow. 2500	0	5 000 - 7000	100
		pow. 7 000	0

VENEZIA S	H	S	L	Pow.	Masa	Poj.	Moc [W]			Cena	
							90/70/20°	75/65/20°	55/45/20°		
VENEZIA S 1600 1/22	22/160/30	1600	300	50	8,69	28,3	4,23	1282	<b>1026</b>	522	<b>3016</b>
VENEZIA S 1600 2/22	22/160/40	1600	400	50	11,6	37,7	5,64	1710	<b>1368</b>	696	<b>3440</b>
VENEZIA S 1600 3/22	22/160/50	1600	500	50	14,5	47,1	7,05	2137	<b>1710</b>	870	<b>3889</b>
VENEZIA S 1600 4/22	22/160/60	1600	600	50	17,39	56,5	8,46	2565	<b>2052</b>	1044	<b>4307</b>
VENEZIA S 1800 1/21	21/180/30	1800	300	50	4,07	28,8	4,77	1147	<b>918</b>	472	<b>2947</b>
VENEZIA S 1800 2/21	21/180/40	1800	400	50	5,43	38,4	6,36	1553	<b>1224</b>	629	<b>3345</b>
VENEZIA S 1800 3/21	21/180/50	1800	500	50	6,79	48	7,95	1912	<b>1530</b>	786	<b>3769</b>
VENEZIA S 1800 4/21	21/180/60	1800	600	50	8,15	57,6	9,54	2295	<b>1836</b>	943	<b>4161</b>
VENEZIA S 1800 1/22	22/180/30	1800	300	50	8,97	31,6	4,77	1387	<b>1107</b>	563	<b>3241</b>
VENEZIA S 1800 2/22	22/180/40	1800	400	50	11,96	42,12	6,36	1845	<b>1476</b>	750	<b>3704</b>
VENEZIA S 1800 3/22	22/180/50	1800	500	50	14,95	52,7	7,95	2306	<b>1845</b>	938	<b>4201</b>
VENEZIA S 1800 4/22	22/180/60	1800	600	50	17,94	63,2	9,54	2767	<b>2214</b>	1125	<b>4674</b>
*) VENEZIA S 2000 1/22	22/200/30	2000	300	50	11,32	34,9	5,31	1485	<b>1188</b>	603	<b>3325</b>
*) VENEZIA S 2000 2/22	22/200/40	2000	400	50	15,1	46,6	7,08	1980	<b>1584</b>	804	<b>3824</b>
*) VENEZIA S 2000 3/22	22/200/50	2000	500	50	18,87	58,2	8,85	2475	<b>1980</b>	1005	<b>4352</b>
*) VENEZIA S 2000 4/22	22/200/60	2000	600	50	22,64	69,8	10,62	2970	<b>2376</b>	1206	<b>4847</b>

\*) Grzejnik dostępny tylko w kolorze białym.

W grzejniku zasilanie **ZAWSZE** z lewej strony.

<b>PODŁĄCZENIA standardowe</b> <i>cena zł netto:</i>	dolne v 50 		<b>opcje</b>	kolor KOLOR +25% dopł. 25 %	możliwość zamówienia innych wymiarów pod zamówienie czas realizacji 3-4 miesiące	
<b>ZAWORY dedykowane</b> (nie są w komplecie z grzejnikiem) <i>cena zł netto:</i>	twins 	<b>578 zł</b>	<b>akcesoria</b>			

# grzejniki standardowe

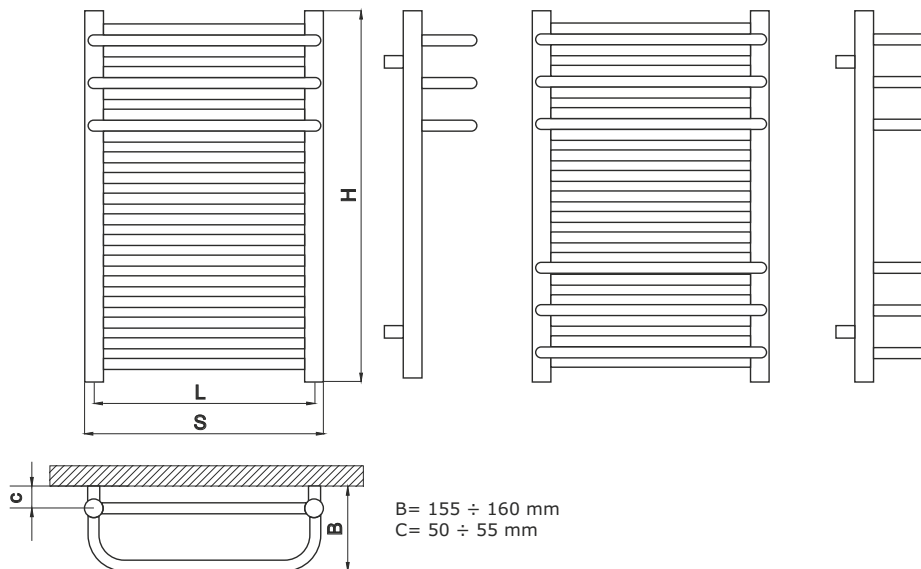

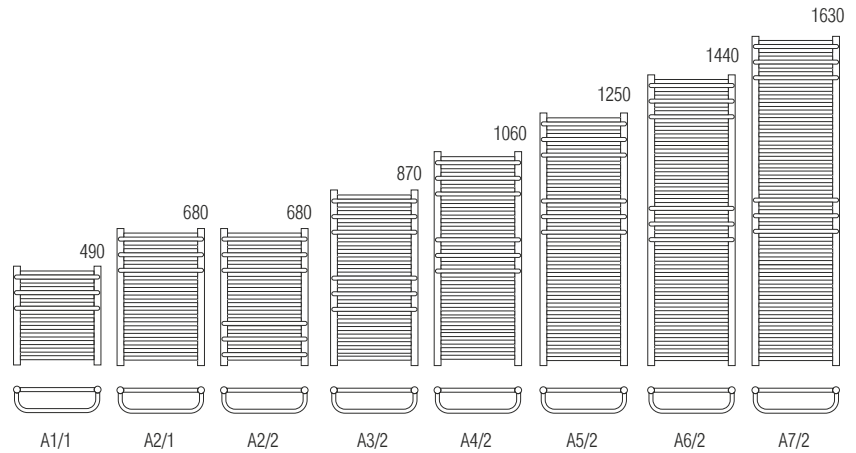

ARIA (A)	H [mm]	S [mm]	L [mm]	Pow. [m <sup>2</sup> ]	Masa [kg]	Poj. [dm <sup>3</sup> ]	Moc grzałki [W]	Moc [W]			Cena [zł netto]
								90/70/20°	75/65/20°	55/45/20°	
A1-350/1	490	385	350	0,42	4,2	1,8	200	280	<b>225</b>	125	<b>385</b>
A2-350/1	680	385	350	0,57	5,6	2,5	300	370	<b>300</b>	165	<b>465</b>
A2-350/2	680	385	350	0,62	6,3	2,8	300	410	<b>330</b>	180	<b>499</b>
A3-350/2	870	385	350	0,78	7,6	3,4	300	565	<b>450</b>	240	<b>567</b>
A4-350/2	1060	385	350	0,92	9,1	4,1	300	635	<b>510</b>	275	<b>654</b>
A5-350/2	1250	385	350	1,06	10,0	4,6	300	750	<b>600</b>	320	<b>717</b>
A6-350/2	1440	385	350	1,20	12,0	5,2	600	865	<b>690</b>	365	<b>802</b>
A7-350/2	1630	385	350	1,33	14,0	5,9	600	930	<b>740</b>	390	<b>909</b>
A1-400/1	490	435	400	0,46	4,7	2,0	200	310	<b>250</b>	135	<b>399</b>
A2-400/1	680	435	400	0,62	6,1	2,4	300	415	<b>335</b>	185	<b>477</b>
A2-400/2	680	435	400	0,76	7,1	3,0	300	525	<b>420</b>	225	<b>515</b>
A3-400/2	870	435	400	0,89	8,5	3,7	300	615	<b>495</b>	265	<b>583</b>
A4-400/2	1060	435	400	1 zł	9,9	4,4	300	705	<b>565</b>	300	<b>656</b>
A5-400/2	1250	435	400	1,15	11,6	5,0	600	835	<b>665</b>	355	<b>741</b>
A6-400/2	1440	435	400	1,33	13,2	5,7	600	955	<b>760</b>	405	<b>826</b>
A7-400/2	1630	435	400	1,48	14,9	6,1	600	1060	<b>840</b>	440	<b>937</b>
A1-500/1	490	535	500	0,55	5,5	2,3	300	380	<b>305</b>	170	<b>426</b>
A2-500/1	680	535	500	0,75	7,2	2,9	300	505	<b>405</b>	220	<b>510</b>
A2-500/2	680	535	500	0,85	8,2	3,3	300	580	<b>465</b>	250	<b>553</b>
A3-500/2	870	535	500	1,04	9,9	4,3	300	710	<b>570</b>	305	<b>637</b>
A4-500/2	1060	535	500	1,22	11,9	5,1	600	825	<b>660</b>	350	<b>720</b>
A5-500/2	1250	535	500	1,41	13,6	5,8	600	925	<b>735</b>	395	<b>804</b>
A6-500/2	1440	535	500	1,60	15,3	6,7	600	1075	<b>855</b>	450	<b>890</b>
A7-500/2	1630	535	500	1,78	17,2	7,3	900	1215	<b>965</b>	505	<b>1010</b>
A1-600/1	490	635	600	0,64	6,2	2,6	300	445	<b>360</b>	195	<b>461</b>
A2-600/1	680	635	600	0,87	8,3	3,5	300	590	<b>475</b>	255	<b>549</b>
A2-600/2	680	635	600	0,99	9,5	4,0	300	675	<b>540</b>	290	<b>612</b>
A3-600/2	870	635	600	1,20	11,7	4,9	600	820	<b>655</b>	350	<b>697</b>
A4-600/2	1060	635	600	1,42	13,7	5,8	600	965	<b>770</b>	405	<b>751</b>
A5-600/2	1250	635	600	1,63	15,8	7,0	600	1110	<b>880</b>	465	<b>877</b>
A6-600/2	1440	635	600	1,85	17,9	8,3	900	1255	<b>995</b>	520	<b>968</b>
A7-600/2	1630	635	600	2,06	20,1	9,1	900	1395	<b>1110</b>	580	<b>1093</b>

<b>PODŁĄCZENIA standardowe</b> <i>cena zł netto:</i>	dolne	krzyżowe	opcje		kolor +40% KOLOR	boczne	dolne v 50	wodno-elekt.	elektryczne
					dopl. 40 %				
<b>ZAWORY dedykowane</b> <small>(nie są w komplecie z grzejnikiem)</small> <i>cena zł netto:</i>	blister standard	standard mini	swing	vision	<b>akcesoria</b> <i>cena zł netto:</i>	grzałki elektr.			
							dopl.: + koszt grzałki (str. 118-119) + koszt napełnienia wg wzoru: pojemn. x 35 zł katalogowo netto		
	<i>od 123 zł</i>	<i>od 227 zł</i>	<i>267 zł</i>	<i>450 zł</i>		(str. 118-119)			

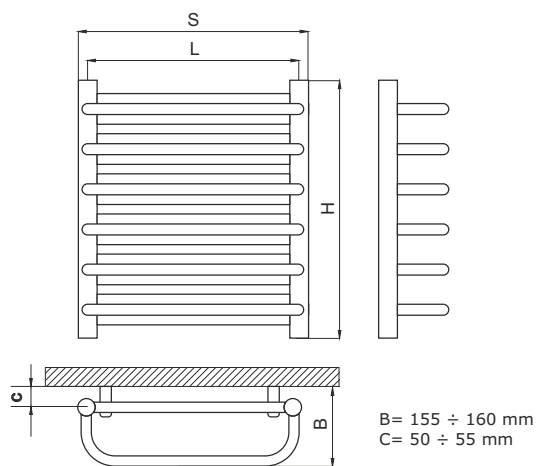

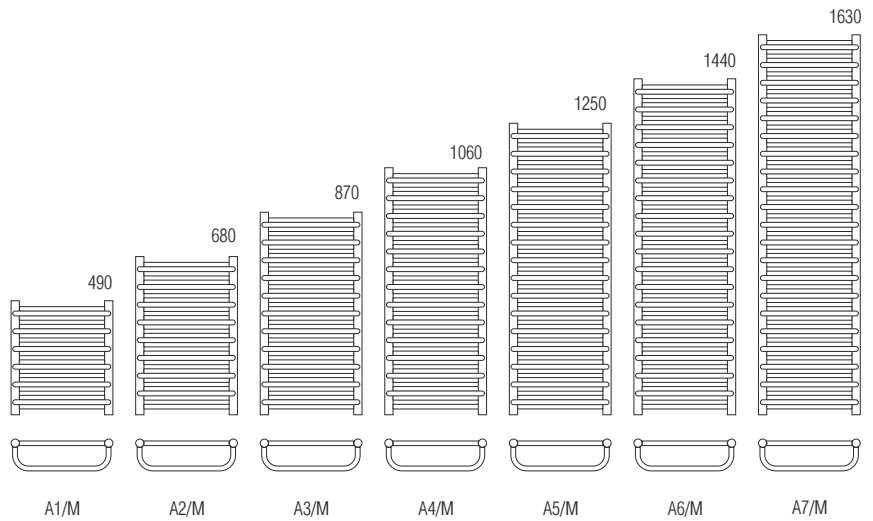

MARIO (A/M)	H [mm]	S [mm]	L [mm]	Pow. [m <sup>2</sup> ]	Masa [kg]	Poj. [dm <sup>3</sup> ]	Moc grzałki [W]	Moc [W]			Cena [zł netto]
								90/70/20°	75/65/20°	55/45/20°	
A1-350/M	490	385	350	0,50	5,1	2,1	200	375	<b>300</b>	165	<b>418</b>
A2-350/M	680	385	350	0,61	6,9	3,2	300	465	<b>375</b>	200	<b>517</b>
A3-350/M	870	385	350	0,91	9,1	3,9	300	575	<b>460</b>	245	<b>623</b>
A4-350/M	1060	385	350	1,09	10,9	4,0	300	685	<b>550</b>	295	<b>719</b>
A5-350/M	1250	385	350	1,31	13,1	4,7	600	820	<b>655</b>	350	<b>833</b>
A6-350/M	1440	385	350	1,53	15,3	5,6	600	945	<b>755</b>	400	<b>930</b>
A7-350/M	1630	385	350	1,75	17,1	6,5	600	1100	<b>875</b>	540	<b>1075</b>
A1-400/M	490	435	400	0,56	5,4	2,3	300	430	<b>345</b>	185	<b>428</b>
A2-400/M	680	435	400	0,78	7,6	3,4	300	540	<b>430</b>	230	<b>527</b>
A3-400/M	870	435	400	1,03	9,8	4,2	300	655	<b>525</b>	280	<b>641</b>
A4-400/M	1060	435	400	1,24	12,1	5,1	600	780	<b>625</b>	335	<b>738</b>
A5-400/M	1250	435	400	1,49	14,4	6,1	600	935	<b>745</b>	395	<b>855</b>
A6-400/M	1440	435	400	1,71	16,7	7,1	600	1080	<b>860</b>	455	<b>956</b>
A7-400/M	1630	435	400	1,93	19,0	8,1	900	1260	<b>1000</b>	525	<b>1105</b>
A1-500/M	490	535	500	0,68	6,5	2,7	300	510	<b>410</b>	220	<b>452</b>
A2-500/M	680	535	500	0,94	8,9	4,0	300	635	<b>510</b>	270	<b>552</b>
A3-500/M	870	535	500	1,23	11,8	4,9	600	780	<b>625</b>	330	<b>682</b>
A4-500/M	1060	535	500	1,49	14,2	6,0	600	935	<b>745</b>	395	<b>787</b>
A5-500/M	1250	535	500	1,79	17,1	7,2	600	1120	<b>890</b>	465	<b>914</b>
A6-500/M	1440	535	500	2,05	19,8	8,3	900	1285	<b>1025</b>	540	<b>1023</b>
A7-500/M	1630	535	500	2,31	22,5	9,4	900	1495	<b>1190</b>	625	<b>1177</b>
A1-600/M	490	635	600	0,79	7,4	3,1	300	560	<b>450</b>	240	<b>482</b>
A2-600/M	680	635	600	1,09	10,3	4,5	300	710	<b>570</b>	300	<b>587</b>
A3-600/M	870	635	600	1,44	15,5	5,6	600	905	<b>720</b>	380	<b>731</b>
A4-600/M	1060	635	600	1,75	16,4	6,8	600	1085	<b>865</b>	455	<b>845</b>
A5-600/M	1250	635	600	2,09	19,6	8,2	900	1315	<b>1045</b>	550	<b>979</b>
A6-600/M	1440	635	600	2,40	22,6	9,6	900	1535	<b>1220</b>	640	<b>1098</b>
A7-600/M	1630	635	600	2,70	25,6	11,0	1200	1800	<b>1435</b>	755	<b>1261</b>

<b>PODŁĄCZENIA standardowe</b> <i>cena zł netto:</i>	dolne	krzyżowe	opcje		kolor +40%	boczne	dolne v 50	wodno-elekr.	elektryczne
				<i>cena zł netto:</i>	dopl. 40 %	<b>dopl. 50 zł</b>	<b>dopl. 70 zł</b>		dopl.: + koszt grzałki (str. 118-119) + koszt napełnienia wg wzoru: pojemn. x 35 zł katalogowo netto
<b>ZAWORY dedykowane</b> <small>(nie są w komplecie z grzejnikiem)</small> <i>cena zł netto:</i>	blister standard	standard mini	swing	vision	akcesoria	grzałki elektr.			
	<b>od 123 zł</b>	<b>od 227 zł</b>	<b>267 zł</b>	<b>450 zł</b>	<i>cena zł netto:</i>	(str. 118-119)			

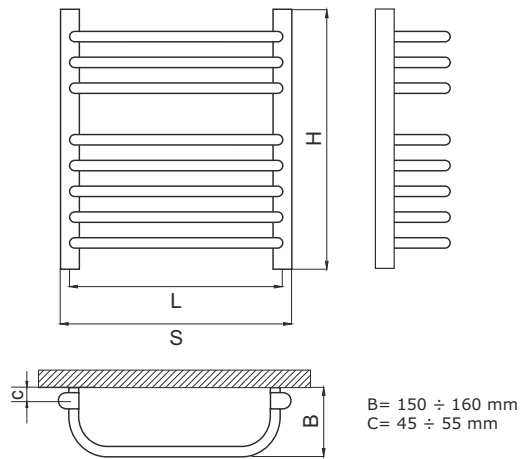

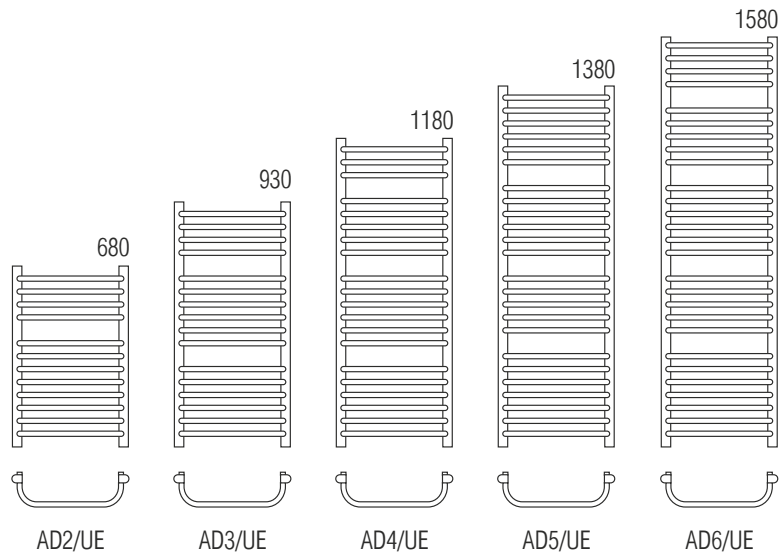

UMBERTO (AD/UE)	H [mm]	S [mm]	L [mm]	Pow. [m <sup>2</sup> ]	Masa [kg]	Poj. [dm <sup>3</sup> ]	Moc grzałki [W]	Moc [W]			Cena [zł netto]
								90/70/20°	75/65/20°	55/45/20°	
AD1-400/UE	480	450	400	0,38	3,3	1,65	200	285	<b>230</b>	125	295
AD2-400/UE	680	450	400	0,54	4,8	2,41	300	405	<b>325</b>	175	367
AD3-400/UE	930	450	400	0,73	6,5	3,24	300	540	<b>430</b>	235	452
AD4-400/UE	1180	450	400	1,04	8,1	4,09	300	670	<b>535</b>	290	532
AD5-400/UE	1380	450	400	1,13	10,1	5,02	600	795	<b>635</b>	345	640
AD6-400/UE	1580	450	400	1,31	11,6	5,77	600	900	<b>720</b>	390	760
AD7-400/UE	1780	450	400	1,50	13,2	6,56	600	1010	<b>810</b>	435	830
AD1-500/UE	480	550	500	0,42	3,7	1,85	200	315	<b>250</b>	135	303
AD2-500/UE	680	550	500	0,62	5,4	2,71	300	460	<b>370</b>	200	382
AD3-500/UE	930	550	500	0,83	7,2	3,64	300	610	<b>490</b>	265	477
AD4-500/UE	1180	550	500	1,17	9,0	4,39	600	760	<b>610</b>	335	561
AD5-500/UE	1380	550	500	1,28	11,1	5,62	600	920	<b>735</b>	395	644
AD6-500/UE	1580	550	500	1,48	12,9	6,23	600	1050	<b>840</b>	455	775
AD7-500/UE	1780	550	500	1,70	14,7	7,44	900	1185	<b>950</b>	515	845
AD1-600/UE	480	650	600	0,47	4,1	2,05	200	375	<b>300</b>	160	312
AD2-600/UE	680	650	600	0,70	6,1	3,01	300	555	<b>445</b>	240	396
AD3-600/UE	930	650	600	0,93	7,9	4,05	300	740	<b>590</b>	315	494
AD4-600/UE	1180	650	600	1,30	9,9	5,09	600	920	<b>735</b>	395	584
AD5-600/UE	1380	650	600	1,43	12,2	6,22	600	1100	<b>880</b>	480	691
AD6-600/UE	1580	650	600	1,65	14,3	7,29	900	1235	<b>990</b>	540	855
AD7-600/UE	1780	650	600	1,89	16,1	8,21	900	1390	<b>1110</b>	605	940

<b>PODŁĄCZENIA standardowe</b> <i>cena zł netto:</i>	dolne	krzyżowe			<b>opcje</b> <i>cena zł netto:</i>	kolor +40%	boczne	wodno-elekt.	elektryczne
						dopl. 40 %			
<b>ZAWORY dedykowane</b> <small>(nie są w komplecie z grzejnikiem)</small> <i>cena zł netto:</i>	blister standard	standard mini	swing	vision	<b>akcesoria</b> <i>cena zł netto:</i>	grzałki elektr.			
							dopl.: + koszt grzałki (str. 118-119) + koszt napełnienia wg wzoru: pojemn. x 35 zł katalogowo netto		
	<i>od 123 zł</i>	<i>od 227 zł</i>	<i>267 zł</i>	<i>450 zł</i>		(str. 118-119)			

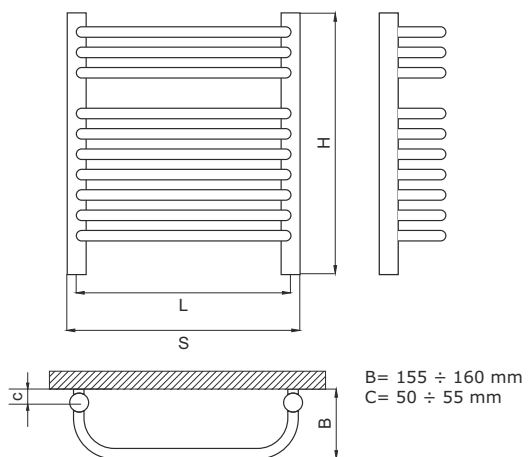

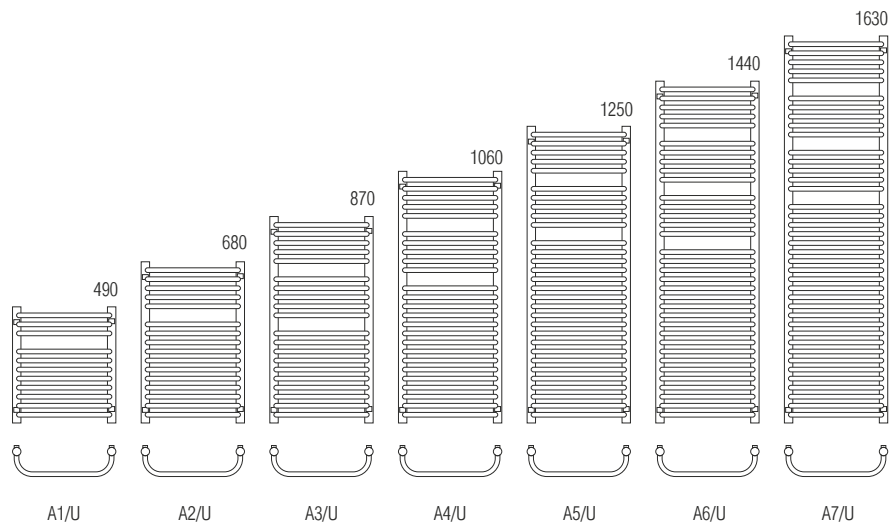

UGO (A/U)	H [mm]	S [mm]	L [mm]	Pow. [m <sup>2</sup> ]	Masa [kg]	Poj. [dm <sup>3</sup> ]	Moc grzałki [W]	Moc [W]			Cena [zł netto]
								90/70/20°	75/65/20°	55/45/20°	
A1-300/U	490	335	300	0,38	3,5	1,8	200	293	<b>235</b>	127	<b>334</b>
A2-300/U	680	335	300	0,55	4,6	2,0	300	400	<b>320</b>	173	<b>410</b>
A3-300/U	870	335	300	0,69	6,1	3,1	300	517	<b>413</b>	224	<b>471</b>
A4-300/U	1060	335	300	0,86	7,5	3,9	300	598	<b>478</b>	259	<b>562</b>
A5-300/U	1250	335	300	1,03	9,2	4,6	300	744	<b>595</b>	322	<b>644</b>
A6-300/U	1440	335	300	1,2	10,7	5,4	600	887	<b>709</b>	383	<b>723</b>
A7-300/U	1630	335	300	1,37	12,2	6,1	600	988	<b>790</b>	427	<b>834</b>
A1-400/U	490	435	400	0,45	4,2	2,0	200	335	<b>270</b>	150	<b>348</b>
A2-400/U	680	435	400	0,65	5,4	2,7	300	470	<b>375</b>	205	<b>428</b>
A3-400/U	870	435	400	0,82	7,2	3,6	300	600	<b>480</b>	260	<b>498</b>
A4-400/U	1060	435	400	1,02	8,9	4,5	300	720	<b>575</b>	310	<b>580</b>
A5-400/U	1250	435	400	1,22	10,8	5,4	600	870	<b>695</b>	370	<b>664</b>
A6-400/U	1440	435	400	1,42	12,6	6,3	600	1010	<b>810</b>	430	<b>748</b>
A7-400/U	1630	435	400	1,62	14,4	7,2	900	1150	<b>920</b>	485	<b>862</b>
A1-500/U	490	535	500	0,52	4,9	2,3	200	380	<b>305</b>	165	<b>369</b>
A2-500/U	680	535	500	0,75	6,2	3,2	300	545	<b>435</b>	235	<b>455</b>
A3-500/U	870	535	500	0,95	8,3	4,2	300	680	<b>550</b>	295	<b>535</b>
A4-500/U	1060	535	500	1,18	10,3	5,2	600	845	<b>675</b>	365	<b>608</b>
A5-500/U	1250	535	500	1,41	12,4	6,3	600	1005	<b>800</b>	430	<b>701</b>
A6-500/U	1440	535	500	1,64	14,5	7,3	900	1145	<b>915</b>	490	<b>790</b>
A7-500/U	1630	535	500	1,87	16,6	8,4	900	1320	<b>1055</b>	555	<b>912</b>
A1-600/U	490	635	600	0,59	5,5	2,6	300	430	<b>345</b>	190	<b>406</b>
A2-600/U	680	635	600	0,85	7,1	3,6	300	620	<b>495</b>	270	<b>506</b>
A3-600/U	870	635	600	1,07	9,4	4,6	600	775	<b>620</b>	335	<b>606</b>
A4-600/U	1060	635	600	1,33	11,8	5,8	600	955	<b>765</b>	410	<b>666</b>
A5-600/U	1250	635	600	1,59	14,0	7,0	900	1145	<b>915</b>	490	<b>747</b>
A6-600/U	1440	635	600	1,86	16,4	8,1	900	1300	<b>1040</b>	550	<b>846</b>
A7-600/U	1630	635	600	2,12	18,8	9,2	900	1490	<b>1190</b>	630	<b>970</b>

<b>PODŁĄCZENIA standardowe</b> <i>cena zł netto:</i>	dolne 	krzyżowe 			opcje <i>cena zł netto:</i>	kolor  dopł. 40 %	boczne  dopł. 50 zł	wodno-elekt. 	elektryczne 
	<b>ZAWORY dedykowane</b> (nie są w komplecie z grzejnikiem) <i>cena zł netto:</i>	blister standard  od 123 zł	standard mini  od 227 zł	swing  267 zł	vision  450 zł	akcesoria <i>cena zł netto:</i>	grzałki elektr.  (str. 118-119)	dopł.: + koszt grzałki (str. 118-119) + koszt napełnienia wg wzoru: pojemn. x 35 zł katalogowo netto	

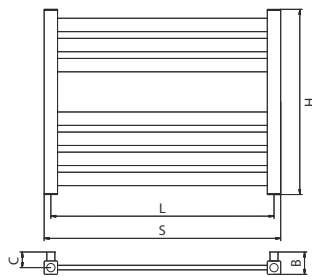

B= 60 ÷ 65 mm  
C= 45 ÷ 50 mm

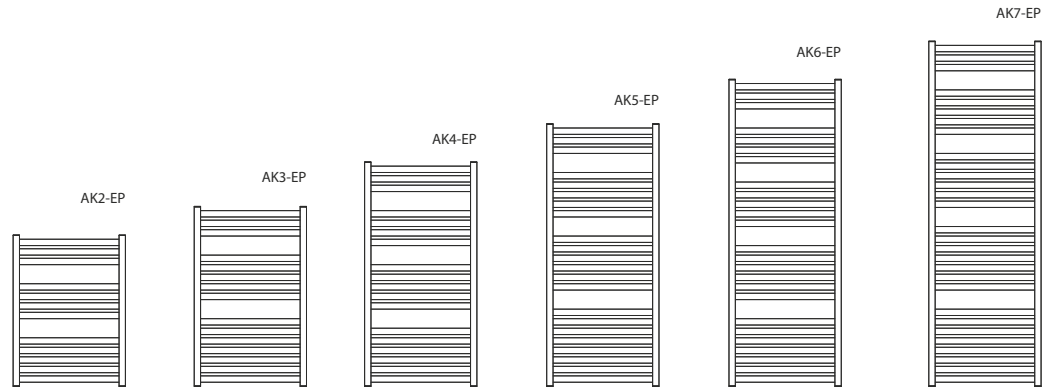

PINO K (AK/EP)	H [mm]	S [mm]	L [mm]	Pow. [m <sup>2</sup> ]	Masa [kg]	Poj. [dm <sup>3</sup> ]	Moc grzałki [W]	Moc [W]			Cena [zł netto]
								90/70/20°	75/65/20°	55/45/20°	
AK1-350/EP	415	380	350	0,21	2,4	1,2	200	198	<b>159</b>	85	<b>370</b>
AK2-350/EP	715	380	350	0,41	5,9	2,8	300	338	<b>271</b>	145	<b>507</b>
AK3-350/EP	850	380	350	0,52	6,2	3,4	300	411	<b>329</b>	177	<b>600</b>
AK4-350/EP	1060	380	350	0,62	8,6	4,1	300	486	<b>389</b>	209	<b>656</b>
AK5-350/EP	1240	380	350	0,76	9,7	4,9	300	597	<b>478</b>	256	<b>742</b>
AK6-350/EP	1450	380	350	0,89	10,8	5,8	600	681	<b>545</b>	291	<b>846</b>
AK7-350/EP	1630	380	350	1,05	12,4	6,5	600	791	<b>632</b>	338	<b>991</b>
AK1-400/EP	415	430	400	0,24	2,9	1,3	200	225	<b>180</b>	100	<b>376</b>
AK2-400/EP	715	430	400	0,45	6,4	2,9	300	375	<b>300</b>	160	<b>514</b>
AK3-400/EP	850	430	400	0,57	6,8	3,5	300	450	<b>360</b>	195	<b>611</b>
AK4-400/EP	1060	430	400	0,68	9,3	4,2	300	530	<b>425</b>	230	<b>669</b>
AK5-400/EP	1240	430	400	0,84	10,6	5,1	600	655	<b>525</b>	285	<b>762</b>
AK6-400/EP	1450	430	400	0,97	11,8	6	600	740	<b>590</b>	320	<b>861</b>
AK7-400/EP	1630	430	400	1,14	13,5	6,8	900	855	<b>685</b>	370	<b>1010</b>
AK1-500/EP	415	530	500	0,3	3,9	1,4	200	235	<b>190</b>	100	<b>393</b>
AK2-500/EP	715	530	500	0,54	7,4	3,2	300	470	<b>310</b>	165	<b>537</b>
AK3-500/EP	850	530	500	0,67	8,1	3,8	300	490	<b>375</b>	200	<b>637</b>
AK4-500/EP	1060	530	500	0,81	10,8	4,5	600	555	<b>445</b>	240	<b>708</b>
AK5-500/EP	1240	530	500	0,99	12,4	5,5	600	680	<b>545</b>	295	<b>816</b>
AK6-500/EP	1450	530	500	1,14	13,8	6,4	900	770	<b>615</b>	330	<b>904</b>
AK7-500/EP	1630	530	500	1,33	15,8	7,4	900	890	<b>710</b>	380	<b>1070</b>
AK1-600/EP	415	630	600	0,35	4,9	1,6	300	280	<b>225</b>	120	<b>418</b>
AK2-600/EP	715	630	600	0,62	8,4	3,4	300	460	<b>370</b>	200	<b>575</b>
AK3-600/EP	850	630	600	0,78	9,3	4,1	600	570	<b>455</b>	245	<b>682</b>
AK4-600/EP	1060	630	600	0,94	12,2	4,9	600	675	<b>540</b>	290	<b>762</b>
AK5-600/EP	1240	630	600	1,14	14,2	5,9	900	810	<b>650</b>	350	<b>886</b>
AK6-600/EP	1450	630	600	1,31	15,8	7	900	920	<b>735</b>	395	<b>974</b>
AK7-600/EP	1630	630	600	1,52	18,1	7,9	900	1060	<b>850</b>	460	<b>1153</b>

Podłączenie dolne V-50 - opcja.

<b>PODŁĄCZENIA standardowe</b> <i>cena zł netto:</i>	dolne	krzyżowe	<b>opcje</b> <i>cena zł netto:</i>	kolor +40% KOLOR	boczne	boczne	dolne v 50	wodno-elekt.	elektryczne
			<i>dopl. 40 %</i>	<i>dopl. 50 zł</i>	<i>dopl. 50 zł</i>	<i>dopl. 70 zł</i>			
<b>ZAWORY dedykowane</b> <small>(nie są w komplecie z grzejnikiem)</small> <i>cena zł netto:</i>	blister standard	standard mini	swing	vision	<b>akcesoria</b> <i>cena zł netto:</i>	grzałki elektr.	suszarka VP	wieszaki	dopl.: + koszt grzałki (str. 118-119) + koszt napełnienia wg wzoru: pojemn. x 35 zł katalogowo netto
	<i>od 123 zł</i>	<i>od 227 zł</i>	<i>267 zł</i>	<i>450 zł</i>		<i>(str. 118-119)</i>	<i>(str. 125)</i>	<i>dopl. (str. 124)</i>	



V50

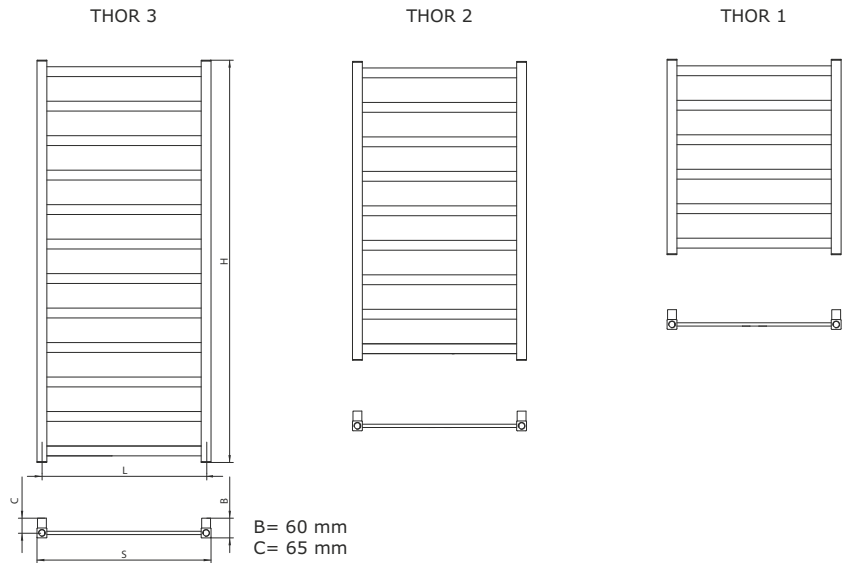

THOR, THOR V50	H [mm]	S [mm]	L [mm]	Pow. [m <sup>2</sup> ]	Masa [kg]	Poj. [dm <sup>3</sup> ]	Moc grzałki [W]	Moc [W]			Cena [zł netto]
								90/70/20°	75/65/20°	55/45/20°	
THOR 1	595	530	500	0,36	4,7	1,5	200	265	<b>210</b>	114	<b>297</b>
THOR 2	910	530	500	0,55	6,7	2,3	300	400	<b>320</b>	170	<b>413</b>
THOR 3	1225	530	500	0,73	8,7	3,1	300	530	<b>425</b>	227	<b>499</b>
THOR 1 V50	595	530	50	0,36	4,7	1,5	200	265	<b>210</b>	114	<b>350</b>
THOR 2 V50	910	530	50	0,55	6,7	2,3	300	400	<b>320</b>	170	<b>466</b>
THOR 3 V50	1225	530	50	0,73	8,7	3,1	300	530	<b>425</b>	227	<b>552</b>

<b>PODŁĄCZENIA standardowe</b> <i>cena zł netto:</i>	dolne	dolne v 50	krzyżowe		<b>opcje</b> <i>cena zł netto:</i>	kolor +40%	boczne	wodno-elekt.	elektryczne
						dopl. 40 %			
<b>ZAWORY dedykowane</b> <small>(nie są w komplecie z grzejnikiem)</small> <i>cena zł netto:</i>	blister standard	standard mini	swing	vision	<b>akcesoria</b> <i>cena zł netto:</i>	grzałki elektr.			

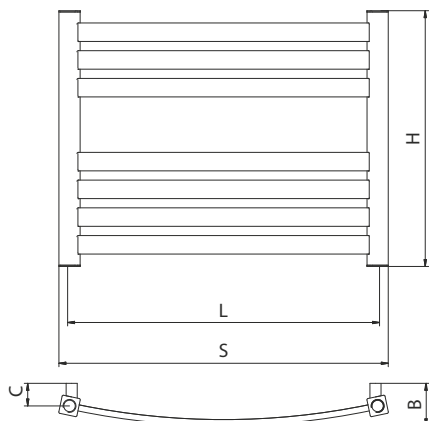

B= 80 ÷ 85 mm  
C= 50 ÷ 55 mm

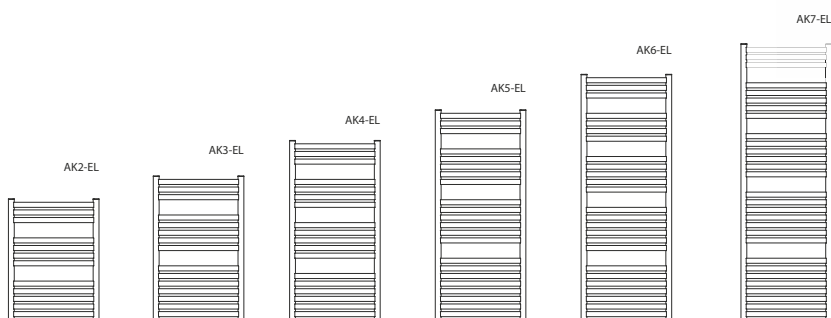

ENZO K (AK/EL)	H [mm]	S [mm]	L [mm]	Pow. [m <sup>2</sup> ]	Masa [kg]	Poj. [dm <sup>3</sup> ]	Moc grzałki [W]	Moc [W]			Cena [zł netto]
								90/70/20°	75/65/20°	55/45/20°	
AK1-500/EL	415	530	500	0,32	4,0	1,4	---	240	<b>195</b>	105	<b>416</b>
AK2-500/EL	715	530	500	0,56	7,5	3,2	300	395	<b>320</b>	170	<b>571</b>
AK3-500/EL	850	530	500	0,69	8,3	3,8	300	490	<b>390</b>	210	<b>677</b>
AK4-500/EL	1060	530	500	0,83	11,1	4,5	300	570	<b>455</b>	245	<b>752</b>
AK5-500/EL	1240	530	500	0,99	12,5	5,5	300	700	<b>560</b>	300	<b>864</b>
AK6-500/EL	1450	530	500	1,15	13,9	6,4	600	795	<b>635</b>	340	<b>965</b>
AK7-500/EL	1630	530	500	1,33	16,1	7,4	600	910	<b>730</b>	395	<b>1133</b>
AK1-600/EL	415	630	600	0,37	4,6	1,6	200	295	<b>235</b>	130	<b>441</b>
AK2-600/EL	715	630	600	0,64	8,5	3,4	300	475	<b>380</b>	205	<b>607</b>
AK3-600/EL	850	630	600	0,79	9,5	4,1	300	595	<b>475</b>	255	<b>726</b>
AK4-600/EL	1060	630	600	0,88	12,4	4,9	300	695	<b>555</b>	300	<b>808</b>
AK5-600/EL	1240	630	600	1,15	14,3	5,8	600	840	<b>670</b>	365	<b>935</b>
AK6-600/EL	1450	630	600	1,32	15,9	6,9	600	950	<b>760</b>	410	<b>1026</b>
AK7-600/EL	1630	630	600	1,53	18,4	7,9	600	1100	<b>880</b>	475	<b>1215</b>

<b>PODŁĄCZENIA standardowe</b> cena zł netto:	dolne 	krzyżowe 			<b>opcje</b>	kolor KOLOR +40%  dopł. 40 %	boczne  dopł. 50 zł	wodno-elekt. 	elektryczne 
	<b>ZAWORY dedykowane</b> (nie są w komplecie z grzejnikiem) cena zł netto:	blister standard  od 123 zł	standard mini  od 227 zł	swing  267 zł		vision  450 zł	<b>akcesoria</b>	grzałki elektr.  (str. 118-119)	suszarka VL  (str. 125)

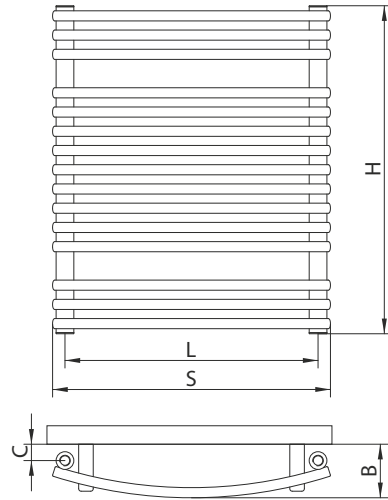

B = 120 ÷ 140 mm  
C = 40 ÷ 60 mm

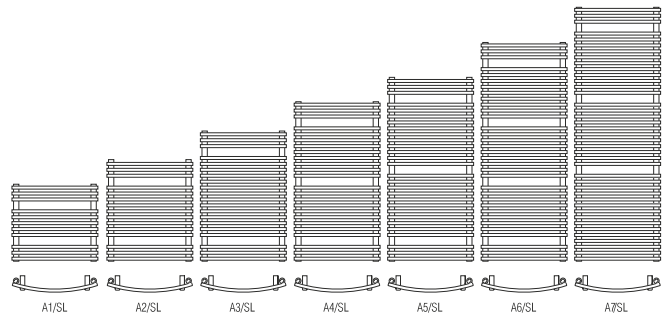

SONIA (A/SL)	H [mm]	S [mm]	L [mm]	Pow. [m <sup>2</sup> ]	Masa [kg]	Poj. [dm <sup>3</sup> ]	Moc grzałki [W]	Moc [W]			Cena [zł netto]
								90/70/20°	75/65/20°	55/45/20°	
A1-500/SL	496	550	500	0,54	4,8	2,6	200	365	<b>295</b>	162	<b>336</b>
A2-500/SL	648	550	500	0,68	6,2	3,3	300	483	<b>390</b>	213	<b>408</b>
A3-500/SL	838	550	500	0,83	7,7	4,0	300	626	<b>505</b>	275	<b>483</b>
A4-500/SL	1028	550	500	1,08	10,0	5,2	600	758	<b>610</b>	332	<b>586</b>
A5-500/SL	1180	550	500	1,26	11,5	6,1	600	860	<b>692</b>	376	<b>677</b>
A6-500/SL	1408	550	500	1,49	13,7	7,1	600	1033	<b>830</b>	449	<b>758</b>
A7-500/SL	1666	550	500	1,76	16,2	8,4	900	1223	<b>981</b>	529	<b>910</b>
A1-600/SL	496	650	600	0,62	5,6	2,9	300	427	<b>345</b>	189	<b>354</b>
A2-600/SL	648	650	600	0,77	7,0	3,7	300	566	<b>457</b>	250	<b>432</b>
A3-600/SL	838	650	600	0,94	8,6	4,5	300	735	<b>592</b>	323	<b>516</b>
A4-600/SL	1028	650	600	1,24	11,2	5,9	600	889	<b>716</b>	389	<b>626</b>
A5-600/SL	1180	650	600	1,43	13,0	6,8	600	1011	<b>813</b>	441	<b>727</b>
A6-600/SL	1408	650	600	1,82	15,4	8,0	900	1214	<b>975</b>	527	<b>771</b>
A7-600/SL	1666	650	600	2,01	18,2	9,5	900	1437	<b>1153</b>	621	<b>984</b>

<b>PODŁĄCZENIA standardowe</b> <i>cena zł netto:</i>	dolne				<b>opcje</b>	kolor  +40% dopl. 40 %	wodno-elekt.	elektryczne
	<b>ZAWORY dedykowane</b> (nie są w komplecie z grzejnikiem) <i>cena zł netto:</i>	blister standard	standard mini	swing		vision	grzałki elektr. (str. 118-119)	dopl.: + koszt grzałki (str. 118-119) + koszt napełnienia wg wzoru: pojemn. x 35 zł katalogowo netto

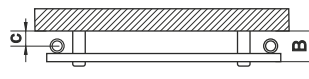
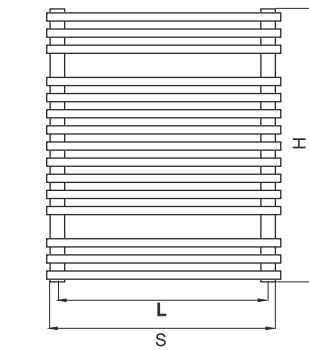

B= 70 ÷ 80 mm  
C= 30 ÷ 40 mm

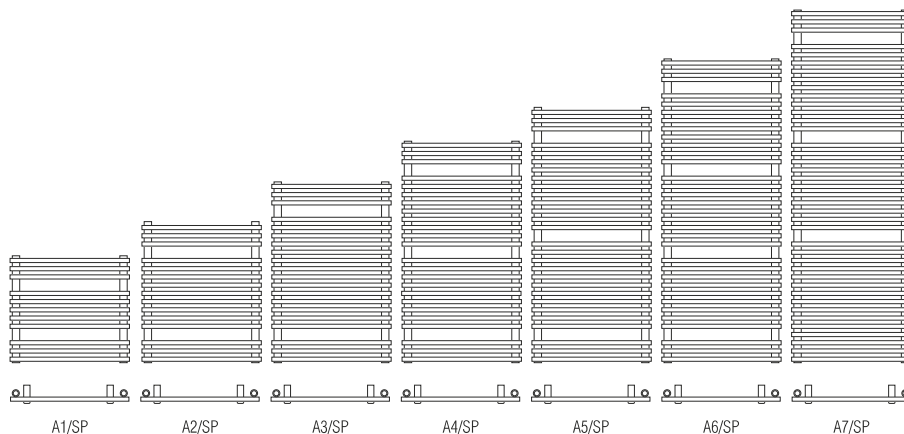

SARA (A/SP)	H [mm]	S [mm]	L [mm]	Pow. [m <sup>2</sup> ]	Masa [kg]	Poj. [dm <sup>3</sup> ]	Moc grzałki [W]	Moc [W]			Cena [zł netto]
								90/70/20°	75/65/20°	55/45/20°	
A1-400/SP	496	450	400	0,45	4,2	2,2	200	306	<b>247</b>	136	<b>316</b>
A2-400/SP	648	450	400	0,57	5,3	2,8	300	393	<b>318</b>	174	<b>382</b>
A3-400/SP	838	450	400	0,69	6,6	3,4	300	514	<b>414</b>	225	<b>445</b>
A4-400/SP	1028	450	400	0,90	8,5	4,4	300	635	<b>513</b>	279	<b>536</b>
A5-400/SP	1180	450	400	1,05	9,9	5,1	300	705	<b>567</b>	309	<b>617</b>
A6-400/SP	1408	450	400	1,24	11,7	6,1	600	848	<b>682</b>	371	<b>689</b>
A7-400/SP	1636	450	400	1,46	13,8	7,1	600	1020	<b>820</b>	446	<b>855</b>
A1-500/SP	496	550	500	0,52	4,8	2,5	200	365	<b>295</b>	162	<b>331</b>
A2-500/SP	648	550	500	0,66	6,1	3,2	300	483	<b>390</b>	213	<b>401</b>
A3-500/SP	838	550	500	0,81	7,5	3,9	300	626	<b>505</b>	275	<b>471</b>
A4-500/SP	1028	550	500	1,05	9,8	5,1	600	758	<b>610</b>	332	<b>570</b>
A5-500/SP	1180	550	500	1,23	11,3	5,9	600	860	<b>692</b>	376	<b>655</b>
A6-500/SP	1408	550	500	1,45	13,4	6,9	600	1033	<b>830</b>	449	<b>731</b>
A7-500/SP	1636	550	500	1,71	15,9	8,2	900	1223	<b>981</b>	529	<b>911</b>
A1-600/SP	496	650	600	0,60	5,5	2,8	300	427	<b>345</b>	189	<b>349</b>
A2-600/SP	648	650	600	0,75	6,9	3,6	300	566	<b>457</b>	250	<b>422</b>
A3-600/SP	838	650	600	0,92	8,4	4,4	300	735	<b>592</b>	323	<b>503</b>
A4-600/SP	1028	650	600	1,21	11,0	5,7	600	889	<b>716</b>	389	<b>605</b>
A5-600/SP	1180	650	600	1,40	12,8	6,6	600	1011	<b>813</b>	441	<b>702</b>
A6-600/SP	1408	650	600	1,79	15,1	7,8	900	1214	<b>975</b>	527	<b>744</b>
A7-600/SP	1636	650	600	1,95	17,9	9,2	900	1437	<b>1153</b>	621	<b>981</b>

<b>PODŁĄCZENIA standardowe</b> cena zł netto:	dolne 					opcje cena zł netto:	kolor  dopł. 40 %	dolne v 50  dopł. 70 zł	wodno-elekt. 	elektryczne  dopł.: + koszt grzałki (str. 118-119) + koszt napełnienia wg wzoru: pojemn. x 35 zł katalogowo netto
<b>ZAWORY dedykowane</b> (nie są w komplecie z grzejnikiem) cena zł netto:	blister standard  od 123 zł	standard mini  od 227 zł	swing  267 zł	vision  450 zł	akcesoria cena zł netto:	grzałki elektr.  (str. 118-119)				

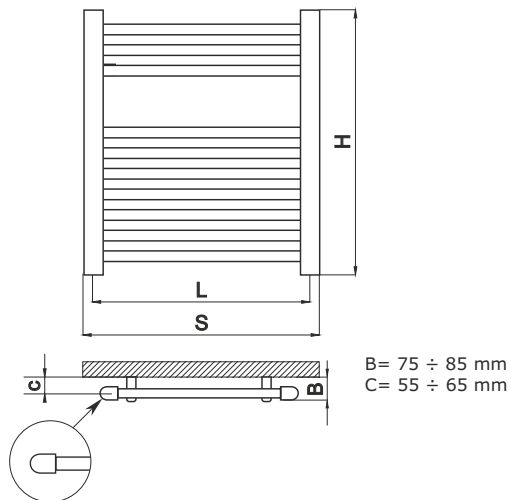

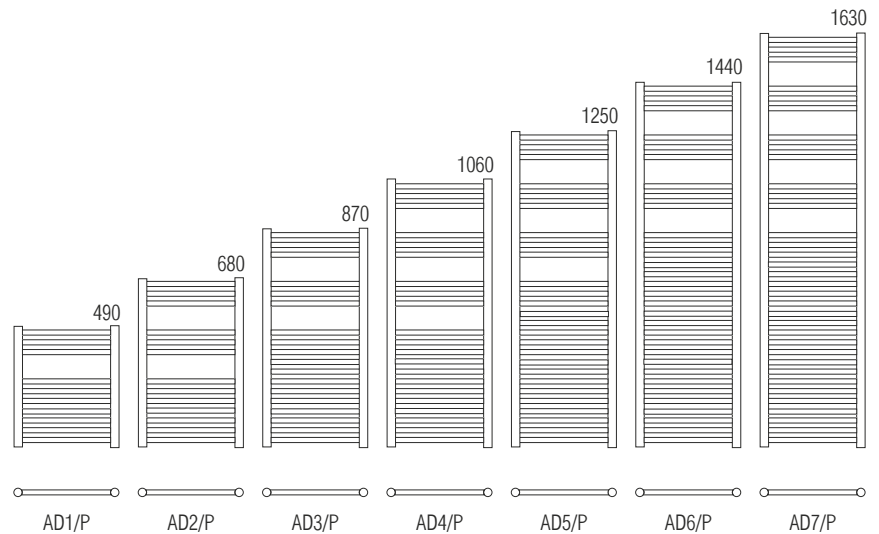

DORA (AD/P)	H [mm]	S [mm]	L [mm]	Pow. [m <sup>2</sup> ]	Masa [kg]	Poj. [dm <sup>3</sup> ]	Moc grzałki [W]	Moc [W]			Cena [zł netto]
								90/70/20°	75/65/20°	55/45/20°	
AD1-400/P	490	450	400	0,36	3,4	1,7	200	270	<b>215</b>	115	<b>301</b>
AD2-400/P	680	450	400	0,46	4,5	2,2	200	360	<b>285</b>	150	<b>354</b>
AD3-400/P	870	450	400	0,61	6,0	3,1	300	450	<b>360</b>	190	<b>421</b>
AD4-400/P	1060	450	400	0,72	7,1	3,8	300	570	<b>455</b>	245	<b>473</b>
AD5-400/P	1250	450	400	0,88	8,5	4,7	300	690	<b>550</b>	295	<b>535</b>
AD6-400/P	1440	450	400	1,10	10,0	5,8	600	785	<b>630</b>	340	<b>607</b>
AD7-400/P	1630	450	400	1,26	11,0	6,6	600	855	<b>685</b>	370	<b>701</b>
AD1-500/P	490	550	500	0,40	3,9	2,0	200	325	<b>260</b>	140	<b>309</b>
AD2-500/P	680	550	500	0,55	5,0	2,5	300	430	<b>345</b>	185	<b>359</b>
AD3-500/P	870	550	500	0,73	6,9	3,7	300	545	<b>435</b>	235	<b>432</b>
AD4-500/P	1060	550	500	0,87	8,1	4,4	300	680	<b>545</b>	290	<b>488</b>
AD5-500/P	1250	550	500	1,06	9,8	5,4	600	825	<b>660</b>	355	<b>556</b>
AD6-500/P	1440	550	500	1,32	11,5	6,5	600	935	<b>745</b>	400	<b>630</b>
AD7-500/P	1630	550	500	1,51	12,7	7,4	600	1015	<b>810</b>	435	<b>719</b>
AD1-600/P	490	650	600	0,47	4,4	2,3	200	375	<b>300</b>	160	<b>320</b>
AD2-600/P	680	650	600	0,64	5,7	2,9	300	495	<b>395</b>	210	<b>383</b>
AD3-600/P	870	650	600	0,84	7,8	4,1	300	630	<b>505</b>	270	<b>461</b>
AD4-600/P	1060	650	600	1,01	9,2	5,0	600	780	<b>625</b>	335	<b>520</b>
AD5-600/P	1250	650	600	1,23	11,0	6,1	600	950	<b>760</b>	410	<b>593</b>
AD6-600/P	1440	650	600	1,53	13,0	7,3	600	1085	<b>865</b>	465	<b>673</b>
AD7-600/P	1630	650	600	1,74	14,3	8,1	900	1175	<b>940</b>	505	<b>766</b>

Przy zamówieniu proszę podać po której stronie ma być zamontowana grzałka - (po prawej lub lewej stronie).

<b>PODŁĄCZENIA standardowe</b> <i>cena zł netto:</i>	dolne	krzyżowe	opcje		kolor +40% KOLOR	boczne	dolne v 50	wodno-elekt.	elektryczne
					dopl. 40 %				
<b>ZAWORY dedykowane</b> <small>(nie są w komplecie z grzejnikiem)</small> <i>cena zł netto:</i>	blister standard	standard mini	swing	vision	akcesoria	grzałki elektr.	suszarka WP	suszarka PP	dopl. : + koszt grzałki (str. 118-119) + koszt napelnienia wg wzoru: pojemn. x 35 zł katalogowo netto
	<i>od 123 zł</i>	<i>od 227 zł</i>	<i>267 zł</i>	<i>450 zł</i>	<i>cena zł netto:</i>	(str. 118-119)	(str 125)	(str 125)	

# ADAMO (AD/L)

GRZEJNIKI STANDARDOWE

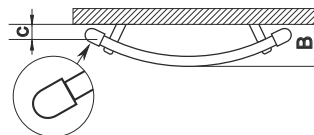
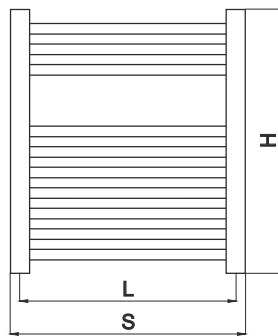

B= 130 ÷ 140 mm  
C= 55 ÷ 65 mm

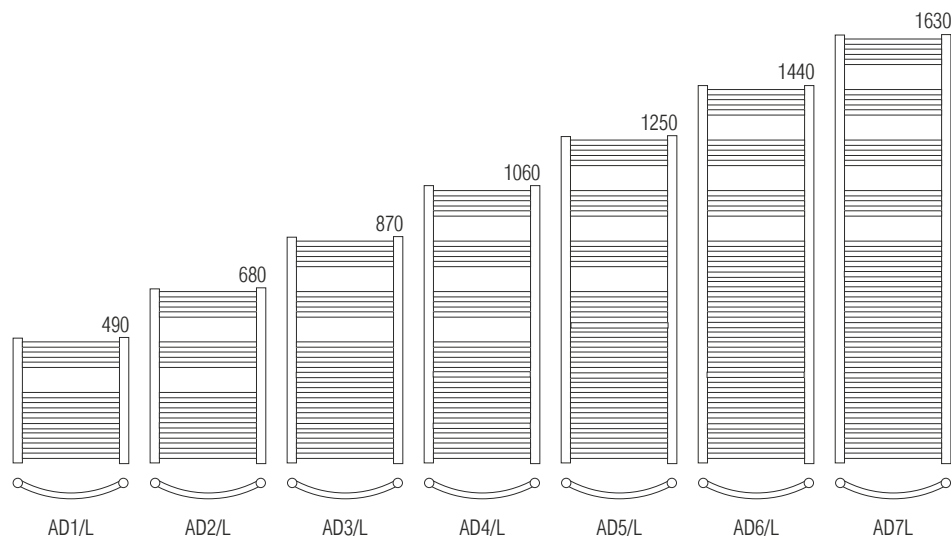

ADAMO (AD/L)	H [mm]	S [mm]	L [mm]	Pow. [m <sup>2</sup> ]	Masa [kg]	Poj. [dm <sup>3</sup> ]	Moc grzałki [W]	Moc [W]			Cena [zł netto]
								90/70/20°	75/65/20°	55/45/20°	
AD1-400/L	490	450	400	0,39	3,5	1,8	200	275	<b>220</b>	115	<b>316</b>
AD2-400/L	680	450	400	0,51	4,5	2,3	200	370	<b>295</b>	155	<b>371</b>
AD3-400/L	870	450	400	0,70	6,2	3,3	300	495	<b>395</b>	210	<b>441</b>
AD4-400/L	1060	450	400	0,81	7,3	4,0	300	585	<b>465</b>	250	<b>496</b>
AD5-400/L	1250	450	400	0,99	8,7	4,9	300	705	<b>565</b>	305	<b>559</b>
AD6-400/L	1440	450	400	1,22	10,3	5,9	600	805	<b>645</b>	345	<b>635</b>
AD7-400/L	1630	450	400	1,33	11,3	6,5	600	870	<b>695</b>	375	<b>722</b>
AD1-500/L	490	550	500	0,44	4,0	2,2	200	330	<b>265</b>	140	<b>323</b>
AD2-500/L	680	550	500	0,57	5,2	2,7	300	440	<b>350</b>	185	<b>377</b>
AD3-500/L	870	550	500	0,78	7,1	3,8	300	585	<b>465</b>	250	<b>453</b>
AD4-500/L	1060	550	500	0,91	8,4	4,6	300	690	<b>550</b>	295	<b>508</b>
AD5-500/L	1250	550	500	1,12	10,2	5,6	600	840	<b>670</b>	360	<b>579</b>
AD6-500/L	1440	550	500	1,37	11,9	6,8	600	960	<b>765</b>	410	<b>653</b>
AD7-500/L	1630	550	500	1,49	13,2	7,6	600	1035	<b>830</b>	445	<b>743</b>
AD1-600/L	490	650	600	0,53	4,5	2,5	200	360	<b>285</b>	150	<b>339</b>
AD2-600/L	680	650	600	0,66	5,9	3,1	300	515	<b>410</b>	220	<b>399</b>
AD3-600/L	870	650	600	0,89	8,0	4,4	300	690	<b>550</b>	295	<b>479</b>
AD4-600/L	1060	650	600	1,05	9,5	5,2	600	835	<b>665</b>	355	<b>543</b>
AD5-600/L	1250	650	600	1,28	11,4	6,3	600	985	<b>785</b>	420	<b>615</b>
AD6-600/L	1440	650	600	1,57	13,4	7,8	600	1120	<b>895</b>	480	<b>692</b>
AD7-600/L	1630	650	600	1,72	14,8	8,7	900	1215	<b>970</b>	520	<b>793</b>

Przy zamówieniu proszę podać po której stronie ma być zamontowana grzałka - (po prawej lub lewej stronie).

<b>PODŁĄCZENIA standardowe</b> <i>cena zł netto:</i>	dolne	krzyżowe			opcje	kolor +40%	boczne	wodno-elekt.	elektryczne
					<i>cena zł netto:</i>				
<b>ZAWORY dedykowane</b> <small>(nie są w komplecie z grzejnikiem)</small> <i>cena zł netto:</i>	blister standard	standard mini	swing	vision	akcesoria	grzałki elektr.	suszarka WL	dopl.: + koszt grzałki (str. 118-119) + koszt napęnienia wg wzoru: pojemn. x 35 zł katalogowo netto	
					<i>cena zł netto:</i>				
	<i>od 123 zł</i>	<i>od 227 zł</i>	<i>267 zł</i>	<i>450 zł</i>		(str. 118-119)	(str. 125)		

# ROSA (AD/R)

## GRZEJNIKI STANDARDOWE

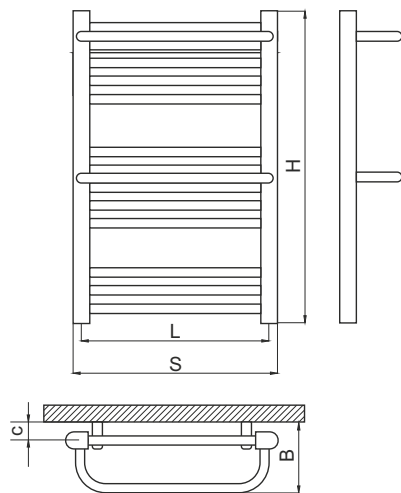

B= 165 ÷ 175 mm  
C= 60 ÷ 70 mm

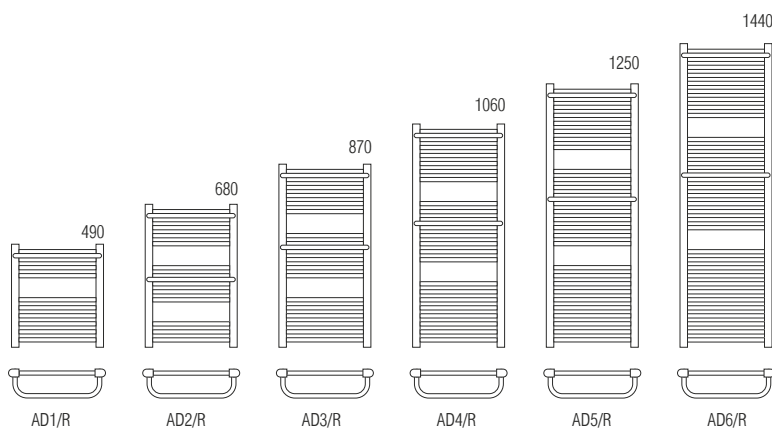

ROSA (AD/R)	H [mm]	S [mm]	L [mm]	Pow. [m <sup>2</sup> ]	Masa [kg]	Poj. [dm <sup>3</sup> ]	Moc grzałki [W]	Moc [W]			Cena [zł netto]
								90/70/20°	75/65/20°	55/45/20°	
AD1-500/R	490	550	500	0,47	4,7	2,1	300	388	<b>310</b>	165	<b>372</b>
AD2-500/R	680	550	500	0,63	5,8	2,7	300	488	<b>390</b>	210	<b>418</b>
AD3-500/R	870	550	500	0,84	7,6	3,6	300	638	<b>510</b>	275	<b>527</b>
AD4-500/R	1060	550	500	0,94	9,4	4,6	300	713	<b>570</b>	305	<b>560</b>
AD5-500/R	1250	550	500	1,14	11,1	5,4	600	838	<b>670</b>	360	<b>633</b>
AD6-500/R	1440	550	500	1,44	13,2	6,1	600	988	<b>790</b>	425	<b>700</b>
AD1-600/R	490	650	600	0,57	5,1	2,5	300	450	<b>360</b>	190	<b>392</b>
AD2-600/R	680	650	600	0,74	6,5	3,1	300	550	<b>440</b>	235	<b>463</b>
AD3-600/R	870	650	600	0,97	8,6	4,1	300	713	<b>570</b>	305	<b>554</b>
AD4-600/R	1060	650	600	1,09	10,6	5,2	600	800	<b>640</b>	345	<b>591</b>
AD5-600/R	1250	650	600	1,32	12,6	6,0	600	963	<b>770</b>	415	<b>668</b>
AD6-600/R	1440	650	600	1,62	14,7	7,4	900	1163	<b>930</b>	500	<b>763</b>

<b>PODŁĄCZENIA standardowe</b> <i>cena zł netto:</i>	dolne 	krzyżowe 	<b>opcje</b> <i>cena zł netto:</i>		kolor +40% dopl. 40 %	boczne  dopl. 50 zł	dolne v 50  dopl. 70 zł	wodno-elekt. 	elektryczne 
	<b>ZAWORY dedykowane</b> (nie są w komplecie z grzejnikiem) <i>cena zł netto:</i>	blister standard  od 123 zł	standard mini  od 227 zł	swing  267 zł	vision  450 zł	<b>akcesoria</b> <i>cena zł netto:</i> (str. 118-119)	grzałki elektr. 	dopl.: + koszt grzałki (str. 118-119) + koszt napełnienia wg wzoru: pojemn. x 35 zł katalogowo netto	

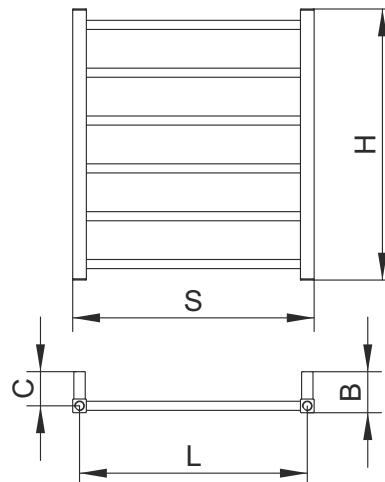

B = 80 ÷ 100 mm  
C = 65 ÷ 85 mm

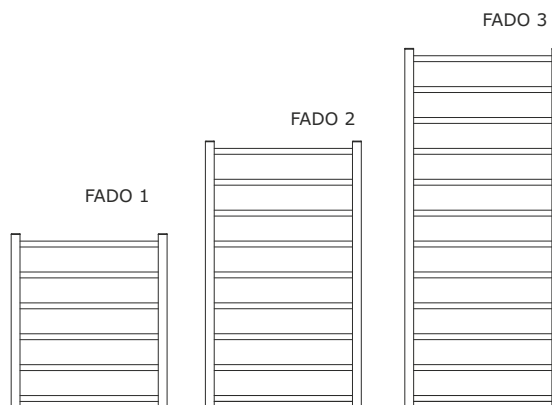

FADO biały lub czarny	H [mm]	S [mm]	L [mm]	Pow. [m <sup>2</sup> ]	Masa [kg]	Poj. [dm <sup>3</sup> ]	Moc grzałki [W]	Moc [W]			Cena [zł netto]	
								90/70/20°	75/65/20°	55/45/20°	biały	czarny
FADO 1	595	530	500	0,32	4,7	1,5	---	245	<b>200</b>	105	440	470
FADO 2	910	530	500	0,49	6,7	2,3	200	340	<b>290</b>	147	540	560
FADO 3	1225	530	500	0,65	8,7	3,1	300	450	<b>360</b>	193	650	680

Przy zamówieniu proszę podać po której stronie ma być zamontowana grzałka - (po prawej lub lewej stronie).

<b>PODŁĄCZENIA standardowe</b> <i>cena zł netto:</i>	dolne	krzyżowe			<b>opcje</b>	kolor +40% dopl. 40 %	boczne dopl. 50 zł	wodno-elekt.	elektryczne
	<b>ZAWORY dedykowane</b> (nie są w komplecie z grzejnikiem) <i>cena zł netto:</i>		blister standard od 123 zł	standard mini od 227 zł		swing 267 zł	vision 450 zł	<b>akcesoria</b> grzałki elektr. (str. 118-119)	dopl.: + koszt grzałki (str. 118-119) + koszt napełnienia wg wzoru: pojemn. x 35 zł katalogowo netto

# GAIA (A/G)

## GRZEJNIKI STANDARDOWE

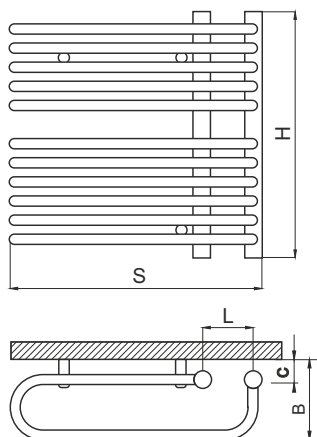

B = 180 ÷ 190 mm  
C = 55 ÷ 65 mm

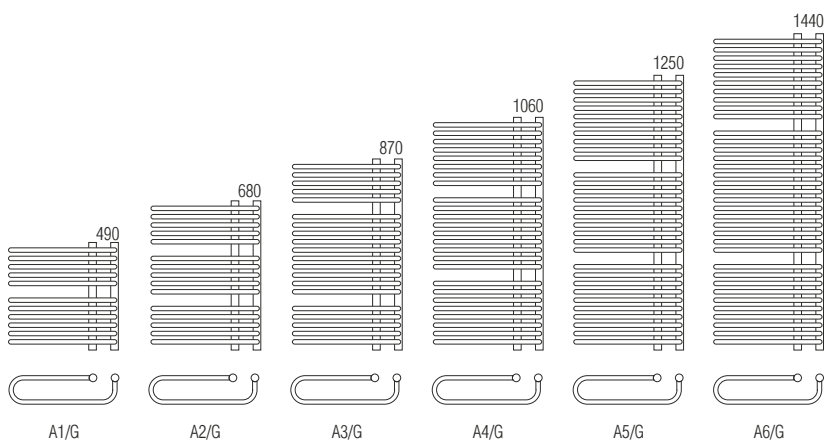

GAIA (A/G)	H [mm]	S [mm]	L [mm]	Pow. [m <sup>2</sup> ]	Masa [kg]	Poj. [dm <sup>3</sup> ]	Moc grzałki [W]	Moc [W]			Cena [zł netto]
								90/70/20°	75/65/20°	55/45/20°	
A1/G	490	500	50	0,77	7,3	3,4	300	560	<b>420</b>	225	<b>459</b>
A2/G	680	500	50	1,11	10,6	4,9	300	810	<b>560</b>	300	<b>559</b>
A3/G	870	500	50	1,40	13,3	6,1	600	1020	<b>730</b>	390	<b>680</b>
A4/G	1060	500	50	1,74	16,4	7,6	600	1270	<b>900</b>	475	<b>764</b>
A5/G	1250	500	50	2,08	19,6	9,1	900	1520	<b>1055</b>	565	<b>898</b>
A6/G	1440	500	50	2,43	22,8	10,5	900	1740	<b>1215</b>	655	<b>1017</b>

Model Gaia A/G jest dwustronny.

<b>PODŁĄCZENIA standardowe</b> <i>cena zł netto:</i>	dolne v 50 	krzyżowe 		<b>opcje</b>	kolor +40%  dopl. 40 %	wodno-elekr. 	elektryczne 	
	<b>ZAWORY dedykowane</b> <small>(nie są w komplecie z grzejnikiem)</small> <i>cena zł netto:</i>	blister standard  <b>od 123 zł</b>	standard mini  <b>od 227 zł</b>		twins  <b>578 zł</b>	<b>akcesoria</b> grzałki elektr.  (str. 118-119)	dopl.: + koszt grzałki (str. 118-119) + koszt napełnienia wg wzoru: pojemn. x 35 zł katalogowo netto	

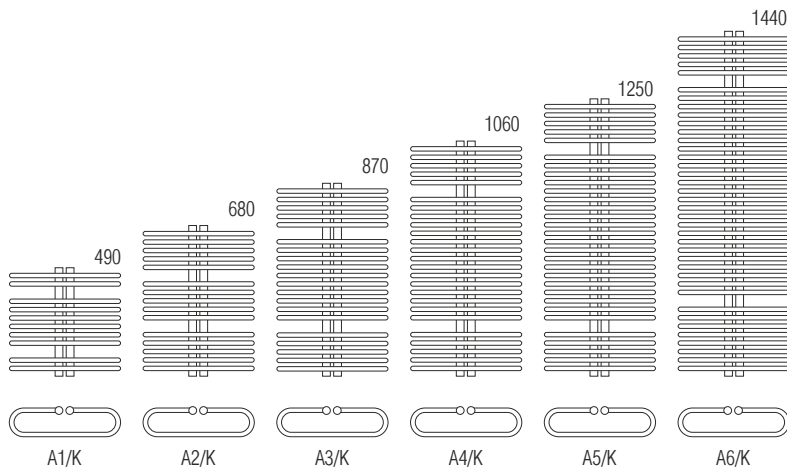
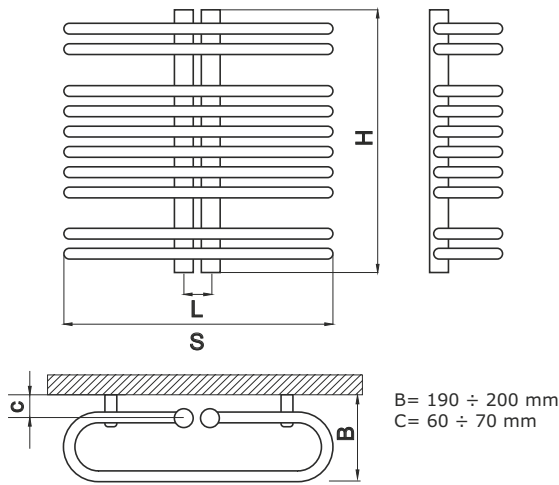

OSCAR (A/K)	H [mm]	S [mm]	L [mm]	Pow. [m <sup>2</sup> ]	Masa [kg]	Poj. [dm <sup>3</sup> ]	Moc grzałki [W]	Moc [W]			Cena [zł netto]
								90/70/20°	75/65/20°	55/45/20°	
A1/K	490	500	50	0,79	7,1	3,3	300	575	<b>470</b>	265	<b>456</b>
A2/K	680	500	50	1,14	9,5	5,1	600	820	<b>660</b>	355	<b>647</b>
A3/K	870	500	50	1,43	12,5	6,4	600	990	<b>790</b>	420	<b>778</b>
A4/K	1060	500	50	1,78	15,5	7,9	900	1190	<b>950</b>	505	<b>968</b>
A5/K	1250	500	50	2,13	18,5	9,5	900	1375	<b>1090</b>	580	<b>1159</b>
A6/K	1440	500	50	2,48	21,5	11,1	900	1535	<b>1220</b>	640	<b>1321</b>

Grzejnik uniwersalny.

<b>PODŁĄCZENIA standardowe</b> <i>cena zł netto:</i>	krzyżowe	dolne v 50		<b>opcje</b>	kolor +40%	wodno-elekt.	elektryczne	
	<b>ZAWORY dedykowane</b> <small>(nie są w komplecie z grzejnikiem)</small> <i>cena zł netto:</i>	blister standard	standard mini		twins	dopl. 40 %		
				<b>akcesoria</b>	grzałki elektr.			
					(str. 118-119)			

# DINO (A/D)

## GRZEJNIKI STANDARDOWE

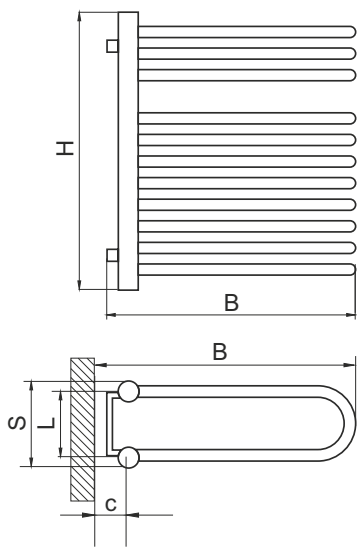

B= 450 mm  
C= 36 mm

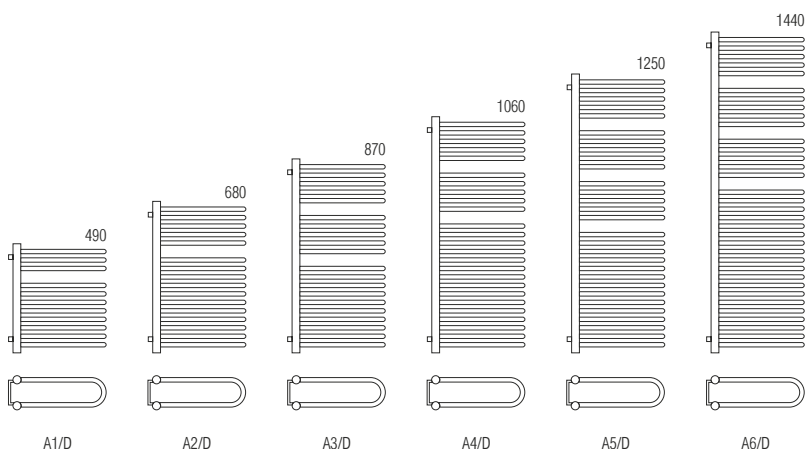

DINO (A/D)	H [mm]	S [mm]	L [mm]	Pow. [m <sup>2</sup> ]	Masa [kg]	Poj. [dm <sup>3</sup> ]	Moc grzałki [W]	Moc [W]			Cena [zł netto]
								90/70/20°	75/65/20°	55/45/20°	
A1/D	490	150	115	0,67	5,2	3,1	300	520	<b>415</b>	220	<b>475</b>
A2/D	680	150	115	0,96	6,7	4,4	300	750	<b>600</b>	320	<b>591</b>
A3/D	870	150	115	1,21	8,9	5,7	600	920	<b>735</b>	395	<b>723</b>
A4/D	1060	150	115	1,50	10,0	7,2	600	1100	<b>880</b>	475	<b>843</b>
A5/D	1250	150	115	1,80	13,3	8,6	900	1320	<b>1055</b>	570	<b>980</b>
A6/D	1440	150	115	2,09	16,6	10,0	900	1535	<b>1230</b>	660	<b>1097</b>

Grzejnik uniwersalny.

<b>PODŁĄCZENIA standardowe</b> cena zł netto:	dolne 	krzyżowe 			opcje kolor +40%  dopł. 40%	wodno-elekr. 	elektryczne 	
	<b>ZAWORY dedykowane</b> (nie są w komplecie z grzejnikiem) cena zł netto:	blister standard  od 123 zł	standard mini  od 227 zł	swing  267 zł	vision  450 zł	akcesoria grzałki elektr.  (str. 118-119)	dopł.: + koszt grzałki (str. 118-119) + koszt napełnienia wg wzoru: pojemn. x 35 zł katalogowo netto	

# grzejniki miedziane



# ARIA CU (A)

## GRZEJNIKI MIEDZIANE

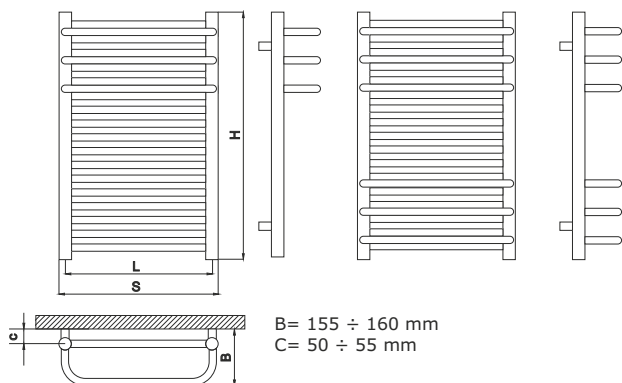

B = 155 ÷ 160 mm  
C = 50 ÷ 55 mm

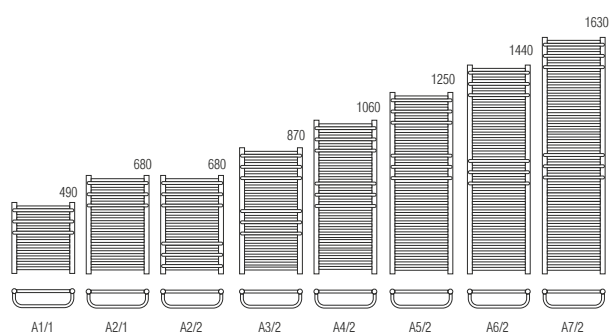

ARIA CU (A)	H [mm]	S [mm]	L [mm]	Pow. [m <sup>2</sup> ]	Masa [kg]	Poj. [dm <sup>3</sup> ]	Moc grzałki [W]	Moc [W]			Cena [zł netto]
								90/70/20°	75/65/20°	55/45/20°	
A1-350/1/Cu	490	385	350	0,38	3,7	1,6	200	265	<b>215</b>	120	978
A2-350/1/Cu	680	385	350	0,51	4,9	2,1	200	350	<b>285</b>	155	1307
A2-350/2/Cu	680	385	350	0,58	5,5	2,4	300	395	<b>315</b>	170	1421
A3-350/2/Cu	870	385	350	0,71	6,7	2,9	300	535	<b>430</b>	230	1593
A4-350/2/Cu	1060	385	350	0,83	8,0	3,5	300	615	<b>495</b>	265	1918
A5-350/2/Cu	1250	385	350	0,96	9,2	4,0	300	735	<b>585</b>	315	2178
A6-350/2/Cu	1440	385	350	1,08	10,3	4,5	600	845	<b>675</b>	360	2495
A7-350/2/Cu	1630	385	350	1,20	11,4	5,1	600	915	<b>730</b>	385	2778
A1-400/1/Cu	490	435	400	0,42	4,1	1,7	200	300	<b>240</b>	135	1024
A2-400/1/Cu	680	435	400	0,55	5,4	2,1	300	400	<b>320</b>	175	1364
A2-400/2/Cu	680	435	400	0,68	6,2	2,6	300	500	<b>400</b>	215	1473
A3-400/2/Cu	870	435	400	0,80	7,5	3,2	300	590	<b>475</b>	255	1698
A4-400/2/Cu	1060	435	400	0,90	8,7	3,8	300	680	<b>545</b>	290	2036
A5-400/2/Cu	1250	435	400	1,04	10,2	4,3	600	810	<b>650</b>	345	2309
A6-400/2/Cu	1440	435	400	1,20	11,6	4,9	600	935	<b>745</b>	395	2621
A7-400/2/Cu	1630	435	400	1,34	13,1	5,3	600	1050	<b>835</b>	440	2916
A1-500/1/Cu	490	535	500	0,50	4,8	2,0	200	360	<b>290</b>	160	1161
A2-500/1/Cu	680	535	500	0,67	6,3	2,5	300	480	<b>385</b>	210	1535
A2-500/2/Cu	680	535	500	0,77	7,2	2,9	300	555	<b>445</b>	240	1659
A3-500/2/Cu	870	535	500	0,93	8,7	3,7	300	680	<b>545</b>	290	1968
A4-500/2/Cu	1060	535	500	1,10	10,5	4,4	600	805	<b>640</b>	340	2349
A5-500/2/Cu	1250	535	500	1,27	12,0	5,0	600	895	<b>715</b>	380	2623
A6-500/2/Cu	1440	535	500	1,44	13,5	5,7	600	1050	<b>835</b>	440	2935
A7-500/2/Cu	1630	535	500	1,61	15,1	6,3	900	1195	<b>950</b>	500	3264

Grzejnik z rur miedzianych.

<b>PODŁĄCZENIA standardowe</b> cena zł netto:	dolne 	krzyżowe 	opcje cena zł netto:	kolor +40%  dopl. 40 %	boczne  dopl. 50 zł	dolne v 50  dopl. 70 zł	wodno-elekt. 	elektryczne 	
<b>ZAWORY dedykowane</b> (nie są w komplecie z grzejnikiem) cena zł netto:	blister standard  od 123 zł	standard mini  od 227 zł	swing  267 zł	vision  450 zł	akcesoria cena zł netto: (str. 118-119)	grzałki elektr. 	dopl.: + koszt grzałki (str. 118-119) + koszt napełnienia wg wzoru: pojemn. x 35 zł katalogowo netto		

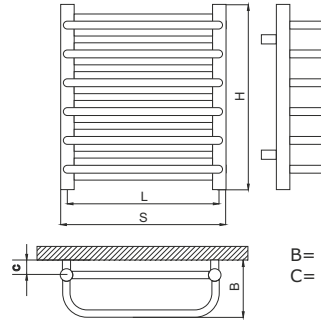

B = 155 ÷ 160 mm  
C = 50 ÷ 55 mm

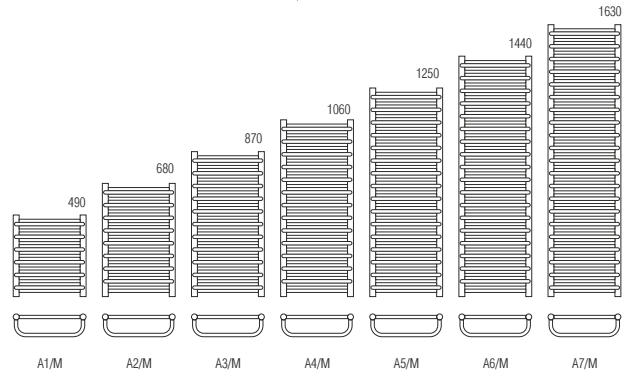

MARIO CU (A/M)	H [mm]	S [mm]	L [mm]	Pow. [m <sup>2</sup> ]	Masa [kg]	Poj. [dm <sup>3</sup> ]	Moc grzałki [W]	Moc [W]			Cena [zł netto]
								90/70/20°	75/65/20°	55/45/20°	
A1-350/M/Cu	490	385	350	0,45	4,4	1,9	200	355	<b>285</b>	155	1180
A2-350/M/Cu	680	385	350	0,60	6,0	2,9	300	445	<b>360</b>	195	1609
A3-350/M/Cu	870	385	350	0,82	7,9	3,4	300	550	<b>440</b>	235	1975
A4-350/M/Cu	1060	385	350	0,99	9,5	3,7	300	665	<b>530</b>	285	2405
A5-350/M/Cu	1250	385	350	1,18	11,4	4,2	600	805	<b>640</b>	340	2756
A6-350/M/Cu	1440	385	350	1,38	13,3	5,0	600	930	<b>740</b>	395	3153
A7-350/M/Cu	1630	385	350	1,55	14,2	5,7	600	1080	<b>860</b>	455	3580
A1-400/M/Cu	490	435	400	0,50	4,7	2,1	300	410	<b>330</b>	175	1219
A2-400/M/Cu	680	435	400	0,69	6,6	3,1	300	515	<b>410</b>	220	1654
A3-400/M/Cu	870	435	400	0,91	8,5	3,8	300	630	<b>505</b>	270	2055
A4-400/M/Cu	1060	435	400	1,10	10,5	4,6	300	760	<b>605</b>	325	2497
A5-400/M/Cu	1250	435	400	1,31	12,5	5,5	600	905	<b>725</b>	385	2877
A6-400/M/Cu	1440	435	400	1,53	14,5	6,4	600	1050	<b>840</b>	445	3279
A7-400/M/Cu	1630	435	400	1,74	16,5	7,3	900	1240	<b>985</b>	520	3722
A1-500/M/Cu	490	535	500	0,60	5,7	2,4	300	485	<b>390</b>	210	1326
A2-500/M/Cu	680	535	500	0,82	7,7	3,6	300	605	<b>485</b>	255	1773
A3-500/M/Cu	870	535	500	1,08	10,3	4,4	300	755	<b>600</b>	320	2254
A4-500/M/Cu	1060	535	500	1,31	12,4	5,4	600	905	<b>720</b>	380	2735
A5-500/M/Cu	1250	535	500	1,57	14,9	6,5	600	1090	<b>865</b>	455	3172
A6-500/M/Cu	1440	535	500	1,83	17,2	7,5	900	1265	<b>1005</b>	530	3605
A7-500/M/Cu	1630	535	500	2,09	19,6	8,5	900	1470	<b>1170</b>	615	4083
A1-600/M/Cu	490	635	600	0,69	6,4	2,8	300	535	<b>430</b>	230	1443
A2-600/M/Cu	680	635	600	0,96	9,0	4,1	300	685	<b>545</b>	290	1910
A3-600/M/Cu	870	635	600	1,26	13,5	5,0	600	870	<b>690</b>	365	2469
A4-600/M/Cu	1060	635	600	1,52	14,3	6,1	600	1050	<b>835</b>	440	2990
A5-600/M/Cu	1250	635	600	1,81	17,1	7,4	900	1285	<b>1020</b>	535	3492
A6-600/M/Cu	1440	635	600	2,10	19,7	8,6	900	1500	<b>1195</b>	630	3953
A7-600/M/Cu	1630	635	600	2,38	22,3	9,9	1200	1770	<b>1410</b>	740	4464

Grzejnik z rur miedzianych.

<b>PODŁĄCZENIA standardowe</b> cena zł netto:	dolne 	krzyżowe 	opcje cena zł netto:		kolor +40% dopl. 40 %	boczne  dopl. 50 zł	dolne v 50  dopl. 70 zł	wodno-elekt. 	elektryczne 
	ZAWORY dedykowane (nie są w komplecie z grzejnikiem) cena zł netto:	blister standard  od 123 zł	standard mini  od 227 zł	swing  267 zł	vision  450 zł	akcesoria cena zł netto:	grzałki elektr.  (str. 118-119)	dopl.: + koszt grzałki (str. 118-119) + koszt napełnienia wg wzoru: pojemn. x 35 zł katalogowo netto	

# UGO CU (A/U)

## GRZEJNIKI MIEDZIANE

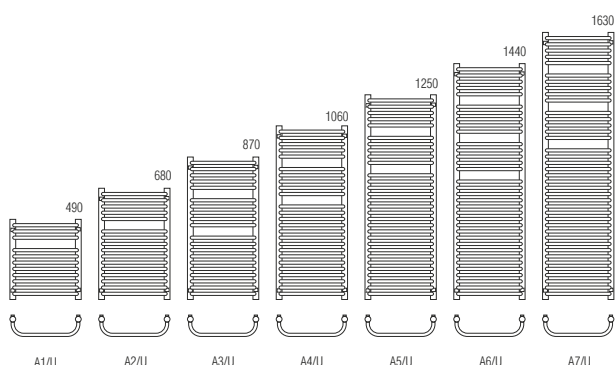
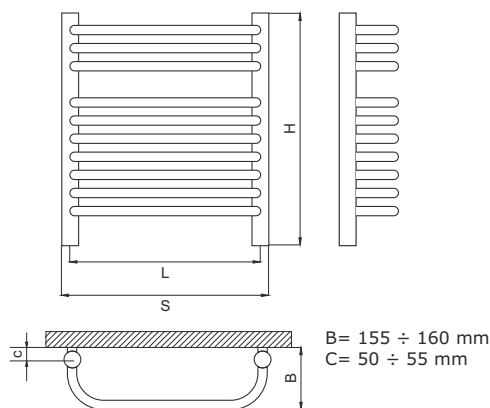

UGO CU (A/U)	H [mm]	S [mm]	L [mm]	Pow. [m <sup>2</sup> ]	Masa [kg]	Poj. [dm <sup>3</sup> ]	Moc grzałki [W]	Moc [W]			Cena [zł netto]
								90/70/20°	75/65/20°	55/45/20°	
A1-400/U/Cu	490	435	400	0,41	4,2	1,7	200	315	<b>255</b>	140	872
A2-400/U/Cu	680	435	400	0,55	5,3	2,3	300	450	<b>360</b>	195	1196
A3-400/U/Cu	870	435	400	0,73	6,8	3,0	300	570	<b>460</b>	245	1435
A4-400/U/Cu	1060	435	400	0,91	8,3	3,8	300	695	<b>555</b>	300	1769
A5-400/U/Cu	1250	435	400	1,09	10,0	4,6	600	840	<b>675</b>	365	2026
A6-400/U/Cu	1440	435	400	1,26	11,6	5,4	600	995	<b>795</b>	425	2323
A7-400/U/Cu	1630	435	400	1,41	13,2	6,3	600	1140	<b>905</b>	480	2605
A1-500/U/Cu	490	535	500	0,48	4,6	1,9	200	360	<b>290</b>	160	954
A2-500/U/Cu	680	535	500	0,66	6,0	2,6	300	515	<b>415</b>	225	1262
A3-500/U/Cu	870	535	500	0,86	7,7	3,5	300	655	<b>525</b>	285	1544
A4-500/U/Cu	1060	535	500	1,08	9,5	4,4	600	810	<b>650</b>	350	1908
A5-500/U/Cu	1250	535	500	1,29	11,5	5,3	600	975	<b>780</b>	420	2186
A6-500/U/Cu	1440	535	500	1,50	13,5	6,2	600	1120	<b>895</b>	475	2522
A7-500/U/Cu	1630	535	500	1,70	15,5	7,1	900	1300	<b>1035</b>	545	2825
A1-600/U/Cu	490	635	600	0,54	5,1	2,2	300	410	<b>330</b>	180	1048
A2-600/U/Cu	680	635	600	0,75	6,7	3,0	300	585	<b>470</b>	255	1346
A3-600/U/Cu	870	635	600	0,98	8,6	4,0	300	745	<b>595</b>	320	1548
A4-600/U/Cu	1060	635	600	1,22	10,6	5,0	600	925	<b>740</b>	395	2069
A5-600/U/Cu	1250	635	600	1,46	13,1	6,0	600	1115	<b>890</b>	475	2370
A6-600/U/Cu	1440	635	600	1,69	15,4	7,0	900	1275	<b>1020</b>	545	2749
A7-600/U/Cu	1630	635	600	1,93	17,7	8,0	900	1465	<b>1170</b>	625	3070

Grzejnik z rur miedzianych.

<b>PODŁĄCZENIA standardowe</b> cena zł netto:	dolne 	krzyżowe 			<b>opcje</b> kolor KOLOR +40%  dopł. 40 % cena zł netto:	boczne  dopł. 50 zł	wodno-elekt. 	elektryczne 
<b>ZAWORY dedykowane</b> (nie są w komplecie z grzejnikiem) cena zł netto:	blister standard  od 123 zł	standard mini  od 227 zł	swing  267 zł	vision  450 zł	<b>akcesoria</b> grzałki elektr.  (str. 118-119) cena zł netto:	dopł.: + koszt grzałki (str. 118-119) + koszt napełnienia wg wzoru: pojemn. x 35 zł katalogowo netto		

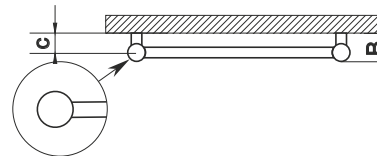
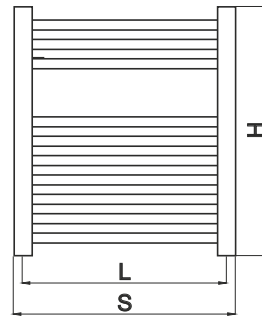

B = 65 ÷ 70 mm  
C = 50 ÷ 55 mm

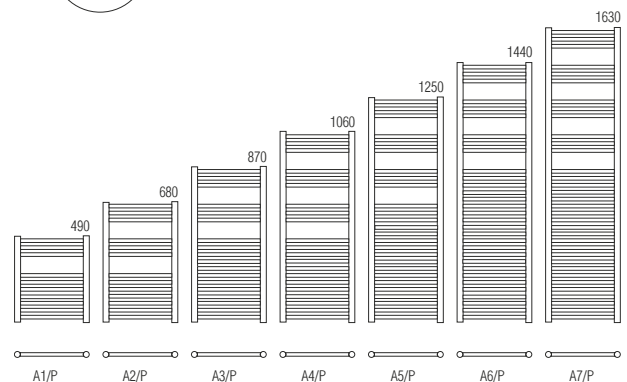

PIETRO CU (A/P)	H [mm]	S [mm]	L [mm]	Pow. [m <sup>2</sup> ]	Masa [kg]	Poj. [dm <sup>3</sup> ]	Moc grzałki [W]	Moc [W]			Cena [zł netto]
								90/70/20°	75/65/20°	55/45/20°	
A1-400/P/Cu	490	435	400	0,32	3,4	1,5	---	245	<b>200</b>	115	<b>824</b>
A2-400/P/Cu	680	435	400	0,40	4,0	2,0	200	330	<b>265</b>	145	<b>1134</b>
A3-400/P/Cu	870	435	400	0,53	5,5	2,7	300	420	<b>335</b>	180	<b>1346</b>
A4-400/P/Cu	1060	435	400	0,63	6,7	3,4	300	540	<b>430</b>	230	<b>1626</b>
A5-400/P/Cu	1250	435	400	0,77	8,2	4,2	300	650	<b>520</b>	280	<b>1864</b>
A6-400/P/Cu	1440	435	400	0,97	9,9	5,2	300	745	<b>595</b>	315	<b>2117</b>
A7-400/P/Cu	1630	435	400	1,10	11,0	6,1	600	820	<b>655</b>	350	<b>2374</b>
A1-500/P/Cu	490	535	500	0,36	3,8	1,8	200	295	<b>240</b>	135	<b>893</b>
A2-500/P/Cu	680	535	500	0,48	4,5	2,3	200	370	<b>300</b>	165	<b>1170</b>
A3-500/P/Cu	870	535	500	0,64	6,5	3,3	300	500	<b>400</b>	215	<b>1406</b>
A4-500/P/Cu	1060	535	500	0,76	7,6	4,0	300	585	<b>470</b>	250	<b>1700</b>
A5-500/P/Cu	1250	535	500	0,93	9,4	4,9	300	715	<b>570</b>	305	<b>1942</b>
A6-500/P/Cu	1440	535	500	1,17	11,5	5,8	600	845	<b>675</b>	360	<b>2225</b>
A7-500/P/Cu	1630	535	500	1,29	12,8	6,5	600	940	<b>750</b>	400	<b>2509</b>
A1-600/P/Cu	490	635	600	0,41	4,2	2,0	200	325	<b>265</b>	145	<b>901</b>
A2-600/P/Cu	680	635	600	0,56	4,9	2,6	300	430	<b>345</b>	190	<b>1268</b>
A3-600/P/Cu	870	635	600	0,75	7,3	3,7	300	570	<b>455</b>	245	<b>1517</b>
A4-600/P/Cu	1060	635	600	0,88	7,9	4,5	300	670	<b>535</b>	285	<b>1838</b>
A5-600/P/Cu	1250	635	600	1,08	10,2	5,5	600	835	<b>665</b>	355	<b>2100</b>
A6-600/P/Cu	1440	635	600	1,35	12,9	6,6	600	990	<b>790</b>	420	<b>2422</b>
A7-600/P/Cu	1630	635	600	1,49	15,3	7,2	600	1095	<b>875</b>	470	<b>2730</b>

Grzejnik z rur miedzianych.

<b>PODŁĄCZENIA standardowe</b> cena zł netto:	dolne	krzyżowe	opcje		kolor +40%	boczne	dolne v 50	wodno-elekr.	elektryczne
					dopl. 40 %				
<b>ZAWORY dedykowane</b> (nie są w komplecie z grzejnikiem) cena zł netto:	blister standard	standard mini	swing	vision	akcesoria	grzałki elektr.			
	od 123 zł	od 227 zł	267 zł	450 zł	cena zł netto:	(str. 118-119)	dopl.: + koszt grzałki (str. 118-119) + koszt napełnienia wg wzoru: pojemn. x 35 zł katalogowo netto		

# LISA CU (A/L)

## GRZEJNIKI MIEDZIANE

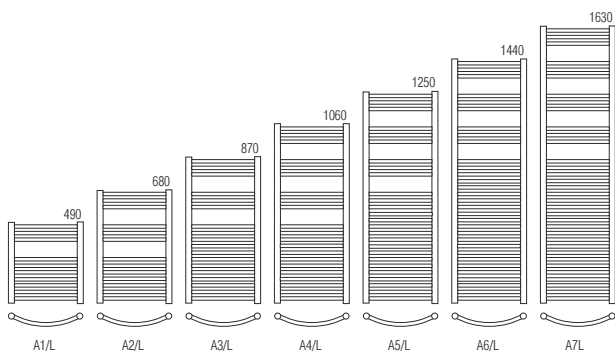
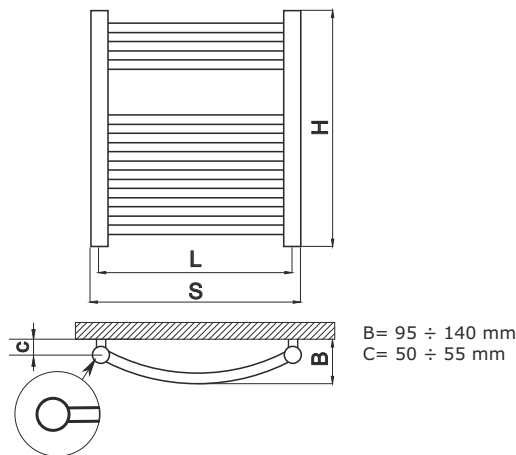

LISA CU (A/L)	H [mm]	S [mm]	L [mm]	Pow. [m <sup>2</sup> ]	Masa [kg]	Poj. [dm <sup>3</sup> ]	Moc grzałki [W]	Moc [W]			Cena [zł netto]
								90/70/20°	75/65/20°	55/45/20°	
A1-400/L/Cu	490	435	400	0,34	3,5	1,6	200	255	<b>205</b>	110	<b>900</b>
A2-400/L/Cu	680	435	400	0,42	4,0	2,0	200	345	<b>275</b>	150	<b>1212</b>
A3-400/L/Cu	870	435	400	0,62	5,8	2,9	300	460	<b>370</b>	200	<b>1464</b>
A4-400/L/Cu	1060	435	400	0,73	6,8	3,5	300	550	<b>440</b>	240	<b>1776</b>
A5-400/L/Cu	1250	435	400	0,89	8,4	4,3	300	665	<b>535</b>	290	<b>2034</b>
A6-400/L/Cu	1440	435	400	1,08	10,2	5,5	600	760	<b>610</b>	330	<b>2332</b>
A7-400/L/Cu	1630	435	400	1,19	11,4	6,3	600	825	<b>665</b>	360	<b>2620</b>
A1-500/L/Cu	490	535	500	0,39	3,9	2,0	200	290	<b>235</b>	125	<b>917</b>
A2-500/L/Cu	680	535	500	0,53	4,6	2,8	300	385	<b>310</b>	170	<b>1308</b>
A3-500/L/Cu	870	535	500	0,70	6,6	3,6	300	520	<b>420</b>	225	<b>1570</b>
A4-500/L/Cu	1060	535	500	0,88	7,8	4,5	300	625	<b>500</b>	270	<b>1914</b>
A5-500/L/Cu	1250	535	500	1,07	9,6	5,4	600	765	<b>615</b>	330	<b>2208</b>
A6-500/L/Cu	1440	535	500	1,23	11,8	6,4	600	910	<b>730</b>	395	<b>2524</b>
A7-500/L/Cu	1630	535	500	1,38	13,1	7,4	600	1005	<b>810</b>	440	<b>2838</b>
A1-600/L/Cu	490	635	600	0,44	4,4	2,3	200	335	<b>270</b>	145	<b>954</b>
A2-600/L/Cu	680	635	600	0,60	5,2	3,2	300	450	<b>360</b>	195	<b>1434</b>
A3-600/L/Cu	870	635	600	0,73	7,4	4,1	300	605	<b>485</b>	260	<b>1732</b>
A4-600/L/Cu	1060	635	600	1 zł	8,9	5,1	300	715	<b>575</b>	310	<b>2136</b>
A5-600/L/Cu	1250	635	600	1,22	10,6	6,1	600	885	<b>710</b>	385	<b>2466</b>
A6-600/L/Cu	1440	635	600	1,41	13,4	7,3	600	1045	<b>840</b>	455	<b>2812</b>
A7-600/L/Cu	1630	635	600	1,51	15,1	8,5	900	1165	<b>935</b>	505	<b>3162</b>

Grzejnik z rur miedzianych.

<b>PODŁĄCZENIA standardowe</b> <i>cena zł netto:</i>	dolne 	krzyżowe 	opcje <i>cena zł netto:</i>	kolor +40% dopl. 40 %	boczne  <i>dopl. 50 zł</i>	dolne v 50  <i>dopl. 70 zł</i>	wodno-elekt. 	elektryczne 	
<b>ZAWORY dedykowane</b> <small>(nie są w komplecie z grzejnikiem)</small> <i>cena zł netto:</i>	blister standard  <i>od 123 zł</i>	standard mini  <i>od 227 zł</i>	swing  <i>267 zł</i>	vision  <i>450 zł</i>	akcesoria  <i>cena zł netto:</i> (str. 118-119)	grzałki elektr. 	dopl.: + koszt grzałki (str. 118-119) + koszt napełnienia wg wzoru: pojemn. x 35 zł katalogowo netto		

# grzejniki nierdzewne

**HELIX****ANILA**

HELIX	H [mm]	S [mm]	L [mm]	Masa [kg]	Moc grzałki [W]	Moc [W] 75/65/20°
HELIX 1 900x500	900	500	50	9,2	---	<b>610</b>
HELIX 2 1410x500	1410	500	50	14,72	---	<b>1002</b>

ANILA	H [mm]	S [mm]	L [mm]	Masa [kg]	Moc grzałki [W]	Moc [W] 75/65/20°
ANILA 1 700x500	700	500	160	5,94	---	<b>400</b>
ANILA 2 900x500	900	500	160	7,58	---	<b>515</b>

**SHELF****CALOR PLUS**

SHELF	H [mm]	S [mm]	L [mm]	Masa [kg]	Moc grzałki [W]	Moc [W] 75/65/20°
SHELF 1 600x530	600	530	500	4,7	---	<b>309</b>
SHELF 2 800x530	800	530	500	5,1	---	<b>336</b>

CALOR PLUS	H [mm]	S [mm]	L [mm]	Masa [kg]	Moc grzałki [W]	Moc [W] 75/65/20°
CALOR PLUS 1 800x500	800	500	470	6,89	---	<b>471</b>
CALOR PLUS 2 1250x500	1250	500	470	11,05	---	<b>756</b>
CALOR PLUS 3 1750x600	1750	600	570	17,03	---	<b>1174</b>

**TRIDEN****TRIDEN PLUS**

TRIDEN	H [mm]	S [mm]	L [mm]	Masa [kg]	Moc grzałki [W]	Moc [W] 75/65/20°
TRIDEN 1 700x530	700	530	160	4,3	---	<b>279</b>
TRIDEN 2 900x630	900	630	160	6,1	---	<b>404</b>

TRIDEN	H [mm]	S [mm]	L [mm]	Masa [kg]	Moc grzałki [W]	Moc [W] 75/65/20°
TRIDEN PLUS 1 900x400	900	400	50	7,69	---	<b>527</b>
TRIDEN PLUS 2 1360x400	1360	400	50	11,45	---	<b>792</b>

**MELODY****MELODY PLUS**

MELODY	H [mm]	S [mm]	L [mm]	Masa [kg]	Moc grzałki [W]	Moc [W] 75/65/20°
MELODY 1 700x770	700	770	160	4,4	---	<b>279</b>
MELODY 2 900x970	900	970	160	6,2	---	<b>404</b>

MELODY PLUS	H [mm]	S [mm]	L [mm]	Masa [kg]	Moc grzałki [W]	Moc [W] 75/65/20°
MELODY PLUS 1 900x690	900	690	50	7,6	---	<b>527</b>
MELODY PLUS 2 1360x690	1360	690	50	11,4	---	<b>792</b>

## PAGO



## ADELE



PAGO	H [mm]	S [mm]	L [mm]	Masa [kg]	Moc grzałki [W]	Moc [W] 75/65/20°
PAGO 1 600x430	600	430	400	3,2	---	<b>189</b>
PAGO 2 600x530	600	530	500	3,7	---	<b>210</b>
PAGO 3 700x430	700	430	400	3,8	---	<b>212</b>
PAGO 4 700x530	700	530	500	4,3	---	<b>248</b>
PAGO 5 800x530	800	530	500	4,8	---	<b>297</b>
PAGO 6 900x430	900	430	400	4,95	---	<b>246</b>
PAGO 7 900x530	900	530	500	5,5	---	<b>320</b>
PAGO 8 1200x530	1200	530	500	7,3	---	<b>400</b>

ADELE	H [mm]	S [mm]	L [mm]	Masa [kg]	Moc grzałki [W]	Moc [W] 75/65/20°
ADELE 500x430	500	430	400	2,6	---	<b>160</b>
ADELE 500x530	500	530	500	3,0	---	<b>186</b>
ADELE 600x430	600	430	400	3,1	---	<b>192</b>
ADELE 600x530	600	530	500	3,3	---	<b>223</b>
ADELE 700x430	700	430	400	3,6	---	<b>224</b>
ADELE 700x530	700	530	500	4,1	---	<b>261</b>
ADELE 800x530	800	530	500	4,6	---	<b>298</b>
ADELE 900x530	900	530	500	5,2	---	<b>335</b>
ADELE 900x630	900	630	600	5,7	---	<b>381</b>
ADELE 1200x430	1200	430	400	5,8	---	<b>384</b>
ADELE 1200x630	1200	630	600	7,6	---	<b>508</b>

grzejniki  
elektryczne  
/ akcesoria



GRZEJNIK ELEKTRYCZNY **EL**

Model L



Model P

Grzałka  
RD10Grzałka  
VOLCANO

GRZEJNIK ELEKTR. EL MODEL L	H [mm]	S [mm]	Masa [kg]	Moc [W] 75/65/20°	z grzałką <b>RD10</b> Cena [zł netto]	z grzałką <b>VOLCANO</b> Cena [zł netto]
GRZEJNIK ELEKTR. EL AD1-500/L	490	550	6,7	<b>300</b>	570	630
GRZEJNIK ELEKTR. EL AD2-500/L	680	550	7,9	<b>300</b>	640	700
GRZEJNIK ELEKTR. EL AD3-500/L	870	550	11,3	<b>300</b>	735	790
GRZEJNIK ELEKTR. EL AD4-500/L	1060	550	13,5	<b>600</b>	803	860
GRZEJNIK ELEKTR. EL AD5-500/L	1250	550	16,6	<b>600</b>	890	960
GRZEJNIK ELEKTR. EL AD6-500/L	1440	550	20,2	<b>600</b>	980	1045

GRZEJNIK ELEKTR. EL model P	H [mm]	S [mm]	Masa [kg]	Moc [W] 75/65/20°	z grzałką <b>RD10</b> Cena [zł netto]	z grzałką <b>VOLCANO</b> Cena [zł netto]
GRZEJNIK ELEKTR. EL AD1-500/P	490	550	6,7	<b>300</b>	570	630
GRZEJNIK ELEKTR. EL AD2-500/P	680	550	7,9	<b>300</b>	640	700
GRZEJNIK ELEKTR. EL AD3-500/P	870	550	11,3	<b>300</b>	735	790
GRZEJNIK ELEKTR. EL AD4-500/P	1060	550	13,5	<b>600</b>	803	860
GRZEJNIK ELEKTR. EL AD5-500/P	1250	550	16,6	<b>600</b>	890	960
GRZEJNIK ELEKTR. EL AD6-500/P	1440	550	20,2	<b>600</b>	980	1045

GRZEJNIK ELEKTRYCZNY **EL FADO**

GRZEJNIK ELEKTR. EL FADO	H [mm]	S [mm]	Masa [kg]	Moc [W] 75/65/20°	Cena [zł netto]
<b>białe</b>					
GRZEJNIK ELEKTR. EL FADO 1	595	530	6,5	<b>300</b>	855
GRZEJNIK ELEKTR. EL FADO 2	910	530	9,0	<b>300</b>	984
GRZEJNIK ELEKTR. EL FADO 3	1225	530	11,8	<b>600</b>	1102
<b>czarne</b>					
GRZEJNIK ELEKTR. EL FADO 1	595	530	6,5	<b>300</b>	891
GRZEJNIK ELEKTR. EL FADO 2	910	530	9,0	<b>300</b>	1004
GRZEJNIK ELEKTR. EL FADO 3	1225	530	11,8	<b>600</b>	1133

Na wyposażeniu suszarki znajduje się zestaw plastikowych konsol mocujących, umożliwiających jej ustawienie pod dowolnym kątem w stosunku do ściany.

	<b>Grzałka RD10</b> biała z kablem 300W 600W 900W	235
	<b>Grzałka RD10</b> chrom z kablem 300W 600W 900W	255
	<b>Grzałka Nord</b> biała z kablem 300W 600W 800W	309
	<b>Grzałka Nord</b> biała z maskownicą 300W 600W 800W	355
	<b>Grzałka HEC</b> biała, czarna z kablem z funkcją TURBO, START-STOP 200W 300W 400W 600W 800W 1000W	355
	<b>Grzałka HEC</b> biała, czarna z maskownicą z funkcją TURBO, START-STOP 200W 300W 400W 600W 800W 1000W	383
	<b>Grzałka HEC</b> biały mat, czarny mat, chrom z kablem z funkcją TURBO, START-STOP 200W 300W 400W 600W 800W 1000W	409
	<b>Grzałka HEC</b> biały mat, czarny mat, chrom z maskownicą z funkcją TURBO, START-STOP 200W 300W 400W 600W 800W 1000W	469
	<b>Grzałka HEC</b> złota z kablem z funkcją TURBO, START-STOP 200W 300W 400W 600W 800W 1000W	728
	<b>Grzałka HEC</b> złota z maskownicą z funkcją TURBO, START-STOP 200W 300W 400W 600W 800W 1000W	728
	<b>Grzałka NEX</b> biały, czarny z kablem z funkcją TURBO, START-STOP, opóźnionym startem 200W 300W 400W 500W 600W 800W 1000W 1200W	422
	<b>Grzałka NEX</b> biały, czarny z maskownicą z funkcją TURBO, START-STOP, opóźnionym startem 200W 300W 400W 500W 600W 800W 1000W 1200W	445
	<b>Grzałka NEX</b> biały mat, czarny mat, chrom z kablem z funkcją TURBO, START-STOP, opóźnionym startem 200W 300W 400W 500W 600W 800W 1000W 1200W	462
	<b>Grzałka NEX</b> biały mat, czarny mat, chrom z maskownicą z funkcją TURBO, START-STOP, opóźnionym startem 200W 300W 400W 500W 600W 800W 1000W 1200W	515
	<b>Grzałka NEX App</b> biały, czarny z kablem z funkcją TURBO, START-STOP, opóźnionym startem, pomiarem temp. pomieszczenia, - obsługa poprzez aplikację 200W 300W 400W 500W 600W 800W 1000W 1200W	699
	<b>Grzałka NEX App</b> biały, czarny z maskownicą z funkcją TURBO, START-STOP, opóźnionym startem, pomiarem temp. pomieszczenia, - obsługa poprzez aplikację 200W 300W 400W 500W 600W 800W 1000W 1200W	729

	<b>Grzałka NEX App</b> czarny mat, chrom z kablem z funkcją TURBO, START-STOP, opóźnionym startem, pomiarem temp. pomieszczenia, - obsługa poprzez aplikację 200W 300W 400W 500W 600W 800W 1000W 1200W	729
	<b>Grzałka NEX App</b> czarny mat, chrom z maskownicą z funkcją TURBO, START-STOP, opóźnionym startem, pomiarem temp. pomieszczenia, - obsługa poprzez aplikację 200W 300W 400W 500W 600W 800W 1000W 1200W	777
	<b>Grzałka GTN</b> biała z kablem 300W 600W 900W 1200W 1500W	340
	<b>Grzałka GTM</b> chrom, kolor* z kablem 300W 600W 900W 1200W 1500W	373
	<b>Grzałka H+E</b> biała z kablem lub maskownicą z funkcją TURBO 300W 600W 900W 1200W	439
	<b>Grzałka H+E</b> chrom, kolor* z kablem lub maskownicą z funkcją TURBO 300W 600W 900W 1200W	465
	<b>Grzałka H+</b> biała z maskownicą, sensorem temperatury otoczenia (ECO DESIGNE), funkcją TURBO i programowaniem tygodniowym 300W 600W 900W 1200W	703
	<b>Grzałka H+</b> chrom, kolor* z maskownicą, sensorem temperatury otoczenia (ECO DESIGNE), funkcją TURBO i programowaniem tygodniowym 300W 600W 900W 1200W	736
	<b>Grzałka H+ Wi-Fi</b> biała z kablem lub maskownicą, sensorem temperatury otoczenia (ECO DESIGNE), funkcją TURBO i programowaniem tygodniowym 300W 600W 900W 1200W	766
	<b>Grzałka H+ Wi-Fi</b> chrom/kolor* z kablem lub maskownicą, sensorem temperatury otoczenia (ECO DESIGNE), funkcją TURBO i programowaniem tygodniowym 300W 600W 900W 1200W	798
	<b>Grzałka horyzontalna HGT</b> biała z kablem 300W 600W 900W 1200W	366
	<b>Grzałka horyzontalna HGT</b> kolor* z kablem 300W 600W 900W 1200W	395
	<b>Grzałka horyzontalna H+h Wi-Fi</b> biała z kablem, sensorem temperatury otoczenia (ECO DESIGNE), funkcją TURBO i programowaniem tygodniowym 300W 600W 900W 1200W 1500W 2000W	766
	<b>Grzałka horyzontalna H+h Wi-Fi</b> chrom, kolor* z kablem, sensorem temperatury otoczenia (ECO DESIGNE), funkcją TURBO i programowaniem tygodniowym 300W 600W 900W 1200W 1500W 2000W	798

## ZAWORY GRZEJNIKOWE

		Kolor	Cena [zł netto]
	<b>Zestaw „Swing”</b> GW 1/2” / GZ 1/2” kątowy lub prosty	Chrom	288
		Biały RAL 9016	288
		Merkury 5, 6, 7 Saturn 1, 2, 4, 7 Mars 6	341
		Czarny RAL 9005	
	<b>Zestaw instalacyjny</b> <b>„Premium Exclusive”</b> wersja kątowna	Chrom	408
		Biały RAL 9016	408
		Merkury 5, 6, 7 Saturn 1, 2, 4, 7 Mars 6	447
		Czarny RAL 9005	
	<b>Zestaw termostatyczny</b> <b>„Vision”</b> lewy lub prawy	Chrom	486
	<b>Zestaw termostatyczny</b> <b>„Vision”</b> lewy lub prawy	Biały RAL 9016	486
	<b>Zestaw termostatyczny</b> <b>„Vision”</b> lewy lub prawy	Merkury 5, 6, 7 Saturn 1, 2, 4, 7 Mars 6	486
		Czarny RAL 9005	
	<b>Zestaw termostatyczny</b> <b>„Vision”</b> lewy lub prawy	Złoty	818

## ZAWORY GRZEJNIKOWE

		Kolor	Cena [zł netto]
	<b>Zestaw termostatyczny „Unico”</b> lewy lub prawy	<i>Chrom</i>	639
		<i>Biały RAL 9016</i>	639
		<i>Merkury 5, 6, 7 Saturn 1, 2, 4, 7 Mars 6</i>	677
		<i>Czarny RAL 9005</i>	
	<b>Zestaw „Twins”</b> GZ 3/4" / GZ 3/4" o rozstawie podłączenia 50 mm lewy lub prawy	<i>Chrom</i>	624
		<i>Biały RAL 9016</i>	624
	*) Przy zamówieniu należy podać po której stronie ma być zasilanie (po prawej / po lewej stronie) oraz rodzaj instalacji - pex/Cu.	<i>Merkury 5, 6, 7 Saturn 1, 2, 4, 7 Mars 6</i>	664
		<i>Czarny RAL 9005</i>	
	<b>Zestaw „Integra”</b> GZ 1/2" / GZ M22 x 1,5 lewy lub prawy	<i>Chrom</i>	633
		<i>Biały RAL 9016</i>	633
		<i>Biały RAL 9016 Merkury 5, 6, 7 Saturn 1, 2, 4, 7 Mars 6</i>	672
		<i>Czarny RAL 9005</i>	
		<i>Złoty</i>	1067

## ZAWORY GRZEJNIKOWE















Tylko na indywidualne zamówienie.

Cena  
[zł netto]

	<b>Blister standard forma kątowa</b> 6022 00027 RAD	123
	<b>Blister standard forma prosta</b> 6022 00028 RAD	123
	<b>Blister standard osiowo prawy</b> 6022 00072 RAD	144
	<b>Blister standard osiowo lewy</b> 6022 00073 RAD	144
	<b>Blister standard osiowo prawy</b> Merkury 6 6022 00086.S0024RAD	279
	<b>Blister standard osiowo lewy</b> Merkury 6 6022 00087.S0024RAD	279
	<b>Zestaw standard mini biały</b> kątowy 6022 00056 prosty 6022 00057	249
	<b>Zestaw standard mini biały</b> osiowo – prawy 6022 00066 osiowo – lewy 6022 00067	227
	<b>Zestaw standard mini chrom</b> kątowy 6022 00060 prosty 6022 00061	281
	<b>Zestaw standard mini chrom</b> osiowo – prawy 6022 00068 osiowo – lewy 6022 00069	260
	<b>Zestaw emas złoty</b>	490

## WIESZAKI I RELINGI

Cena  
[zł netto]









	<b>WCR1</b> - RELING CHROMOWANY <i>Cedro, Wall</i>	124
	<b>WK1</b> - RELING KOLOR MALOWANY <i>Cedro, Wall</i>	85
	<b>WCR2</b> - RELING CHROMOWANY <i>Cedro, Wall, Target Plus, Target H, Caja, Calle</i>	198
	<b>WK2</b> - RELING KOLOR MALOWANY <i>Cedro, Wall, Target Plus, Target H, Caja, Calle</i>	137
	<b>WCR3</b> - RELING CHROMOWANY <i>Caja, Cedro, Wall</i>	226
	<b>WK3</b> - RELING KOLOR MALOWANY <i>Caja, Cedro, Wall</i>	158
	<b>WCR4</b> - RELING CHROMOWANY <i>Stone</i>	198
	<b>WK4</b> - RELING KOLOR MALOWANY <i>Stone</i>	137
	<b>RCR1</b> - RELING CHROMOWANY OKALAJĄCY <i>Wall, Imperador</i>	330
	<b>RCR2</b> - RELING CHROMOWANY POJEDYŃCZY <i>Wall, Imperador</i>	267
	<b>RK1</b> - RELING OKALAJĄCY KOLOR <i>Wall, Imperador</i>	225
	<b>RK2</b> - RELING POJEDYŃCZY KOLOR <i>Wall, Imperador</i>	191
	<b>RA1</b> - RELING ANODOWANY OKALAJĄCY dostępny w kolorze srebrnym, czarnym i czerwonym <i>Parys</i>	267
	<b>RA2</b> - RELING ANODOWANY POJEDYŃCZY dostępny w kolorze srebrnym, czarnym i czerwonym <i>Parys</i>	210
	<b>RAK1</b> - RELING ANODOWANY OKALAJĄCY KWADRATOWY dostępny w kolorze srebrnym, czarnym i czerwonym <i>Wall, Imperador</i>	267

# WIESZAKI I RELINGI

Cena  
[zł netto]

	<b>RAK2</b> - RELING ANODOWANY POJEDYŃCZY KWADRATOWY dostępny w kolorze: srebrnym, czarnym i czerwonym <i>Wall, Imperador</i>	210
	<b>WDO</b> - WIESZAK DOSPAWANY OKRĄGŁY <i>Caja, Calle, Torget Plus, Torget H</i>	32
	<b>WDK</b> - WIESZAK DOSPAWANY KWADRATOWY <i>Caja, Calle, Torget Plus, Torget H, Tubo K</i>	45
	<b>WK</b> - WIESZAK  <i>Luca, Caja, Calle, Torget Plus, Torget H</i> <i>Enzo, Pino</i> <i>Bora</i>	53
	<b>WLK 10</b> - WIESZAK <i>Enzo, Pino, Escalera, Alvo, Luca</i>	58
	<b>WLK 30</b> - WIESZAK <i>Rod, Livia T Cr, Loco, Loco mini,</i> <i>Loft, Loft Plus , Vibo</i>	47
	<b>WN 50/70</b> - WIESZAK WKRĘCANY ZE STALI NIERDZEWNEJ 50 mm / 70 mm grzejniki z kolektorem pionowym okrągłym, kwadratowym lub półowalnym; gwint 1/2'	159
	<b>WN-200/250</b> - WIESZAK WKRĘCANY ZE STALI NIERDZEWNEJ 200/250 mm grzejniki z okrągłym kolektorem z gwintem 1/2'	224

## WIESZAKI I RELINGI

			Cena [zł netto]
	<b>LIU</b> wieszak międzyrurkowy przykręcany - biały	110 003	67 (2 szt.)
	<b>BIAGIO</b> wieszak magnetyczny biały	210 103	88
	<b>HOOK</b> wieszak narurkowy biały	121 001	39
	<b>HOOK</b> wieszak narurkowy przezroczysty	121 002	39
	<b>HOOK</b> wieszak narurkowy chrom	121 003	52
	<b>FLIP</b> wieszak do grzejników biały, czarny		12 (1 kpl. - 2 szt.)
	<b>BOA</b> wieszak do kabin prysznicowych chrom	245 005	65
	<b>CLIP</b> wieszak do grzejników aluminiowych	246 001	117
	<b>FLEX</b> wieszak odchylany międzyrurkowy biały	150 001	198

## WIESZAKI PRZYKRĘCANE WP, VP, WL, PP, VL, VPP

Modele VP, VL, VPP różnią się od modeli WP, WL i PP rodzajem mocowań.





	Cena [zł netto]		Cena [zł netto]	Przeznaczone do modeli
WP 400	85	WP 400 CR	143	A/P i AD/P o szer. 400 mm
WP 500	88	WP 500 CR	148	A/P i AD/P o szer. 500 mm
WP 600	92	WP 600 CR	156	A/P i AD/P o szer. 600 mm
VP 400	85	VP 400 CR	143	AK/EP o szer. 400 mm
VP 500	88	VP 500 CR	148	AK/EP o szer. 500 mm
VP 600	92	VP 600 CR	156	AK/EP o szer. 600 mm
WL 400	90	WL 400 CR	152	A/L i AD/L o szer. 400 mm
WL 500	92	WL 500 CR	156	A/L i AD/L o szer. 500 mm
WL 600	97	WL 600 CR	165	A/L i AD/L o szer. 600 mm
VL 500	92	VL 500 CR	156	AK/EL o szer. 500 mm
VL 600	97	VL 600 CR	165	AK/EL o szer. 600 mm
PP 500	266	PP 500 CR	556	A/P i AD/P o szer. 500 mm
PP 600	280	PP 600 CR	591	A/P i AD/P o szer. 600 mm
VPP 500	266	VPP 500 CR	556	AK/EP o szer. 500 mm
VPP 600	280	VPP 600 CR	591	AK/EP o szer. 600 mm

## MOCOWANIA DO GRZEJNIKÓW

		Cena [zł netto]		
		białe	kolor	chrom
	<p>Komplet mocowań plastikowych (3 lub 4 szt.) do grzejników: model Aria (A), Mario (A/M), Pino (AK/EP), Enzo (AK/EL), Rosa (AD/R), Dora (AD/P), Adamo (AD/L), Gaia (A/G), Oscar (A/K), Atena (A/T), Arez (A/Z)</p>	45	80	---
	<p>Komplet mocowań (4 szt.) do grzejników „DESIGN”</p>	---	80	105

## KOREK I ODPOWIETRZNIKI

NAZWA	Cena [zł netto]	NAZWA	Cena [zł netto]	NAZWA	Cena [zł netto]
 korek półcalowy z oringiem	3 zł	 półcalowy odpowietrznik z oringiem	3,50	 półcalowy odpowietrznik z oringiem chromowany	9,60

## PRZYKŁADY WZORÓW NA SZKLE DLA GRZEJNIKA COSTA



1

5

8

9

10

12

13

14

## WARUNKI ZAKUPU

1. Wszystkie zamówienia prosimy kierować tylko i wyłącznie na adres mailowy: [handlowy@alplast.pl](mailto:handlowy@alplast.pl)
2. Po otrzymaniu niniejszego potwierdzenia anulowanie zamówienia możliwe jest jedynie po uprzedniej akceptacji Działu Sprzedaży, mail: [handlowy@alplast.pl](mailto:handlowy@alplast.pl)
3. Brak akceptacji, o której mowa w pkt. 2 skutkuje obowiązkiem uiszczenia pełnej płatności za towar.
4. Brak odbioru towaru nie zwalnia z obowiązku o jakim mowa w punkcie 3.
5. Firma ALPLAST zastrzega sobie prawo do wstrzymania realizacji złożonego przez Państwa zamówienia, w przypadku powstania zaległości w płatnościach z Państwa strony, do czasu uregulowania należności.
6. W sprawie pytań dotyczących wysyłek, prosimy o kontakt z Działem Handlowym pod nr telefonu 52 327 22 22.
7. Wszelkie nieprawidłowości w dostawie należy zgłaszać do 48h od dnia otrzymania dostawy.
8. Dopłata za:
  - kolor: + 40 %
  - kolor + nietypowość: + 60%

## MOC CIEPLNA GRZEJNIKÓW

W tabelach podano normalną moc cieplną dla parametrów wody grzejnej 75/65/20°C oraz moc dla parametrów 90/70/20°C.

Aby uzyskać moc cieplną grzejnika dla innych parametrów, wystarczy pomnożyć moc podaną dla parametrów 75/65/20°C przez odpowiedni współczynnik z tabeli przedstawionej poniżej.

t1	t2	tw=20C	tw=24C	t1	t2	tw=20C	tw=24C
90	80	1,38	1,27	70	60	0,88	0,78
	75	1,31	1,21		55	0,82	0,73
	70	1,25	1,15		50	0,76	0,67
85	75	1,25	1,15	65	55	0,76	0,67
	70	1,19	1,09		50	0,7	0,61
	65	1,12	1,02		45	0,65	0,56
80	70	1,12	1,02	60	50	0,65	0,56
	65	1,06	0,96		45	0,59	0,5
	60	1 zł	0,9		40	0,54	0,45
75	65	1 zł	0,9	55	45	0,54	0,45
	60	0,94	0,84		40	0,48	0,4
	55	0,88	0,78		35	0,43	0,35

## SPOSOBY PODŁĄCZENIA GRZAŁEK



z zestawem przystosowanym pod grzałkę



z trójnikiem



z trójnikiem



z przyłączem jednootworowym



z duo-plexem

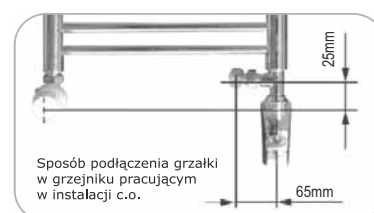

Sposób podłączenia grzałki w grzejniku pracującym w instalacji c.o.

[www.radeco.com.pl](http://www.radeco.com.pl)  
[www.b2b.radeco.pl](http://www.b2b.radeco.pl)

producent:

Przedsiębiorstwo  
ALPLAST sp. z o.o. sp.k.  
ul. Rynkowska 2  
85-503 Bydgoszcz

tel.:

52 327 22 22 wew. 18, 20

52 327 22 23 wew. 18, 20

52 322 21 25

506 451 089

e-mail:

[handlowy@alplast.pl](mailto:handlowy@alplast.pl)

Aktualny cennik na stronie:



[www.radeco.com.pl/do-pobrania](http://www.radeco.com.pl/do-pobrania)



dystybutor:



[www.arkady.net.pl](http://www.arkady.net.pl)