

Industrial Batteries / Network Power

Marathon M-FT

»AGM modular power«

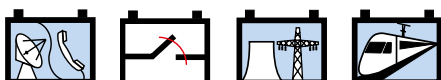

Industrial Batteries

The powerful range of Network Power

GNB® Industrial Power offers reliable energy storage solutions for critical systems requiring uninterrupted power supply. With a comprehensive product range based on state-of-the-art technologies, GNB delivers the right battery for every application.

The below table is only indicative and depends on the specific customer application. For more information please ask a GNB sales representative.

APPLICATIONS	BATTERY RANGES																		
	Sonnenschein						Marathon			Sprinter		Absolyte	Powerfit	Classic					
	A400/A600	A400 FT	A500	SOLAR	RAIL	Power Cycle	M-FT	FTX	L/XL	P/XP	XP-FT	GP/GX	S100/S100L/S300	OCSM	OPzS	Energy Bloc/OGi	OPzS Solar	EnerSol	rail
UPS Data Centre	●	●	●			●	●	●	●	●	●			●		●			
Industrial UPS	●	●	●			●	●	●	●	●	●			●		●			
Telecom Good grid	●	●				●	●	●	●	●					●	●			
Telecom Poor & Off-grid				●		●						●		●				●	
Renewable				●		●						●						●	●
Emergency lighting	●	●	●			●	●	●	●	●	●		●		●	●			
Security	●		●							●	●		●	●	●				
Utility	●	●				●	●	●	●			●		●	●	●			
Railways	●	●	●		●	●	●	●				●		●		●			●

Powerful product brands



- > VRLA batteries (Valve Regulated Lead Acid) in which the electrolyte is fixed in an Absorbent Glass Mat (AGM)
- > Excellent high current capability
- > Very economical
- > Maintenance-free (no topping up)



- > VRLA batteries (Valve Regulated Lead Acid) in which the electrolyte is fixed in a gel (dryfit® technology)
- > Inventor of Gel technology
- > Highest reliability, even in non-optimal conditions
- > Particularly suitable for cyclic applications
- > Maintenance-free (no topping up)



- > Conventional lead-acid batteries with liquid electrolyte
- > Extreme reliability, proven over decades
- > Low maintenance

Marathon M-FT

The safe storage system with long design life

Designed for durability in telecommunications and electric utility applications, the Marathon M-FT series provides high performance and reliability in medium and long duration discharge applications. The location of the terminals on the front (vs. the top) of the battery greatly facilitates the installation and maintenance of the product when placed in a cabinet enclosure or on a standard relay rack tray.

Your benefits:

- > **Improved Total Cost of Ownership** - due to a very long design life: 15 years
- > **Front terminal design** – easy access for faster installation and maintenance
- > **Durable polypropylene casing (available as flame retardant)** – maintains structural integrity in higher operating temperatures
- > **Short recharging time** – high availability
- > **Optimal energy density** – saves floor space
- > **Completely recyclable** – low CO₂ footprint



Specifications:

- > Design life: 15 years (until 80% C10 at 20°C and 1.80Vpc)
- > EUROBAT 2015 Classification: »>12 years – Very Long Life«
- > Maintenance-free (no topping up) during the whole service life
- > High-Compression Absorbent Glass Mat (AGM) technology
- > Nominal capacity 35.0 – 200 Ah
- > Central degassing
- > Available as standard or flame retardant version (UL 94 V-0)
- > Grid plates with superior lead low calcium high tin alloy
- > Very low gassing due to internal gas recombination (99 % efficiency)
- > Low self discharge rate, enabling extended storage capability
- > Designed in accordance with IEC 60896-21/-22
- > Approval: Underwriters Laboratories (UL)
- > Trouble-free transportation of operational blocks and cells. no restriction for most rail, road, sea and air transportation (IATA, DGR clause A67)
- > Manufactured in Europe in our ISO 9001 certified production plants

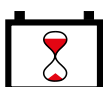

Design life
15 years



Nominal capacity
35.0 – 200 Ah



Block battery

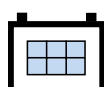

Grid plate



Recyclable



Valve regulated
lead-acid
batteries



Maintenance
free (no
topping up)

Marathon M-FT

Technical data

Technical characteristics and data

Type	Part number	Nom. voltage V	Nominal capacity C ₁₀ 1.80 Vpc 20°C Ah	Capacity C ₈ 1.75 Vpc 25°C Ah	Capacity C ₃ 1.70 Vpc 20°C Ah	Capacity C ₁ 1.60 Vpc 20°C Ah	Length (l) max. mm	Width (b/w) max. mm	Height (h) max. mm	Weight approx. kg	Internal resistance mOhm**	Short circuit current A**	Terminal
M6V200FT	NAMT060200HM0FB	6	200	200	167	140	361*	132	250	34.0	1.7	3461	F-M6
M12V35FT	NAMF120035HM0MB	12	35.0	35.0	30.8	27.0	280	107	189	14.0	11.0	1149	M-M6-90°
M12V50FT	NAMF120050HM0MB	12	47.0	48.0	41.1	34.9	280	107	231	18.0	8.2	1547	M-M6-90°
M12V60FT	NAMF120060HM0MB	12	59.0	59.0	50.2	40.8	280	107	263	23.0	7.0	1794	M-M6-90°
M12V90FT	NAMF120090HM0FB	12	86.0	86.0	75.2	65.3	395	105	270	31.0	5.1	2440	F-M6-90°
M12V100FT	NAMF120100HM0FB	12	100	103	89.4	75.0	395	105	287	33.0	5.0	2445	F-M6-90°
M12V105FT	NAMF120105HM0FB	12	100	104	86.6	71.3	511	110	238	35.8	4.9	2554	F-M6-90°
M12V125FT	NAMF120125HM0FB	12	121	125	112	89.4	559	124	283	47.6	4.7	2640	F-M6-90°
M12V155FT	NAMF120155HM0FB	12	155	158	133	105	559	124	283	52.8	3.8	3292	F-M6-90°
M12V190FT	NAMF120190HM0FB	12	190	193	168	140	559	125	318	60.0	3.4	3653	F-M6-90°

*Installed length of type M6V200FT: 376 mm

**According to IEC 60896-21/22

Container, terminal and torque

Figures are also valid for UL 94 V-0 version,
Change »H« to »V« in the part number, E.g.:

> **Standard:** NAMF120035 **H** MOMB

> **UL 94 V-0:** NAMF120035 **V** MOMB

Container material:

Standard Polypropylene (PP) according to UL 94 HB or
flame retardant Polypropylene (PP) according to UL 94 V-0.

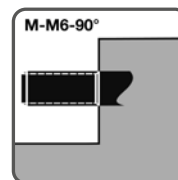

6 Nm

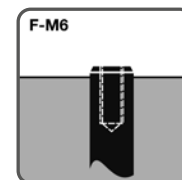

11 Nm

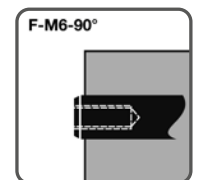

11 Nm

Marathon M-FT

Drawings Marathon M-FT

M6V200FT

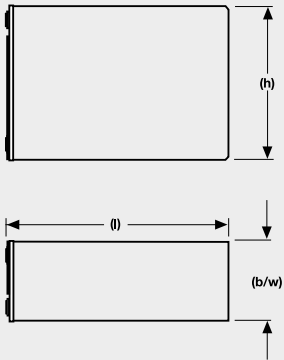

M12V35FT

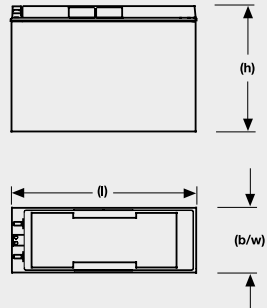

M12V50FT

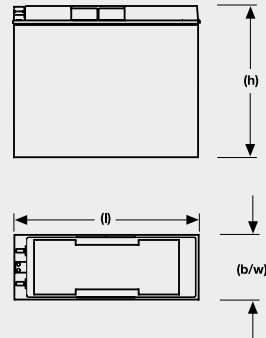

M12V60FT

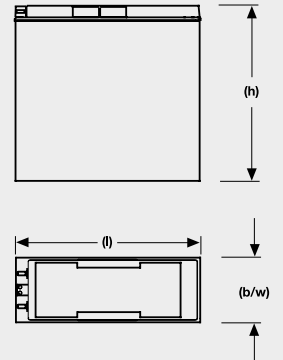

**M12V90FT
M12V100FT**

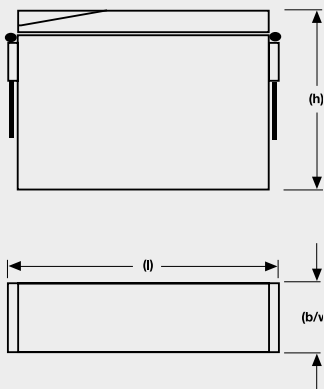

M12V105FT

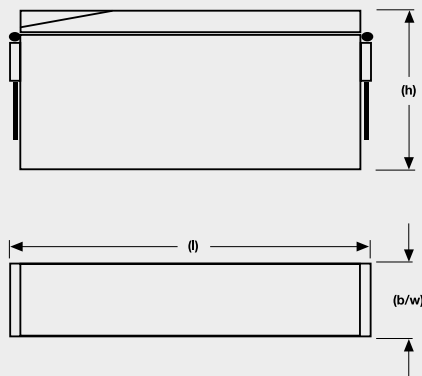

**M12V125FT -
M12V190FT**

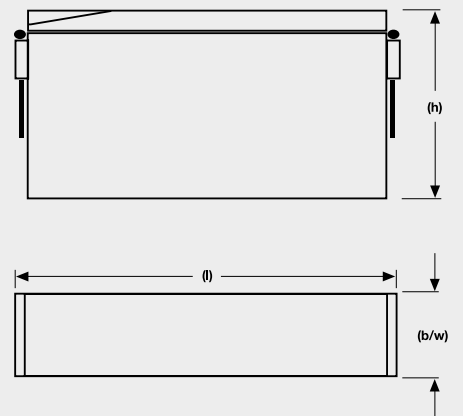

Not to scale!

Marathon M-FT

Constant current discharge

1.94 Vpc – Discharge in A at 20 °C

Type	3 min	5 min	10 min	15 min	30 min	1 h	1.5 h	2 h	3 h	5 h	8 h	10 h	12 h	24 h
M6V200FT	131	131	131	131	115	90.7	67.7	54.9	40.3	27.3	18.8	15.4	13.1	7.05
M12V35FT	77.0	70.0	55.0	45.6	32.1	19.9	14.0	10.9	7.7	4.96	3.30	2.72	2.32	1.27
M12V50FT	110	100	81.0	67.3	43.6	26.1	18.7	14.8	10.5	6.72	4.41	3.61	3.06	1.64
M12V60FT	114	105	86	72.9	49.7	30.5	22.1	17.5	12.7	8.45	5.63	4.61	3.91	2.10
M12V90FT	100	100	100	100	73.0	47.0	33.9	26.8	19.5	12.7	8.37	6.86	5.84	3.15
M12V100FT	115	115	115	115	80.0	50.0	35.0	31.0	22.5	14.8	9.80	8.00	6.80	3.60
M12V105FT	121	121	121	121	79.9	52.4	38.3	30.6	22.3	14.9	9.74	7.96	6.75	3.60
M12V125FT	97.5	97.5	97.5	97.5	77.8	62.1	45.6	36.6	27.0	17.3	11.4	9.47	8.00	4.22
M12V155FT	189	175	145	122	95.1	74.0	56.2	46.3	33.5	21.8	14.4	11.7	9.96	5.28
M12V190FT	152	149	142	135	115	90.0	68.0	55.8	40.2	26.6	18.0	14.8	12.7	6.90

1.92 Vpc – Discharge in A at 20 °C

Type	3 min	5 min	10 min	15 min	30 min	1 h	1.5 h	2 h	3 h	5 h	8 h	10 h	12 h	24 h
M6V200FT	159	159	159	159	133	97.7	72.7	59.0	43.1	29.0	20.0	16.3	13.9	7.47
M12V35FT	90.0	80.0	62.0	50.2	34.4	21.3	15.0	11.7	8.3	5.28	3.50	2.88	2.46	1.34
M12V50FT	122	110	88.0	73.0	46.8	28.0	20.1	15.9	11.2	7.10	4.66	3.82	3.24	1.74
M12V60FT	122	112	93.0	79.2	53.7	33.1	23.8	18.9	13.6	9.11	5.98	4.89	4.16	2.23
M12V90FT	110	110	110	110	80.0	50.5	36.2	28.5	20.4	13.4	8.86	7.26	6.17	3.33
M12V100FT	130	130	130	130	87.0	53.0	37.1	32.5	23.5	15.6	10.4	8.50	7.22	3.83
M12V105FT	132	132	132	132	86.0	55.8	40.6	32.3	23.5	15.8	10.3	8.42	7.13	3.79
M12V125FT	125	125	125	125	91.7	67.3	49.4	39.7	29.1	18.5	12.1	10.1	8.53	4.48
M12V155FT	215	198	170	149	108	78.8	59.7	49.0	35.1	23.0	15.3	12.5	10.5	5.60
M12V190FT	180	176	166	156	131	100	75.0	61.0	44.5	29.0	19.3	15.9	13.6	7.40

1.90 Vpc – Discharge in A at 20 °C

Type	3 min	5 min	10 min	15 min	30 min	1 h	1.5 h	2 h	3 h	5 h	8 h	10 h	12 h	24 h
M6V200FT	187	187	187	187	150	105	77.9	63.0	45.8	30.6	21.1	17.2	14.7	7.92
M12V35FT	105	93.0	70.0	56.4	36.8	22.8	16.0	12.5	8.8	5.61	3.71	3.05	2.60	1.41
M12V50FT	140	125	97.0	79.3	50.1	29.6	21.3	16.9	11.9	7.52	4.92	4.02	3.41	1.83
M12V60FT	145	130	103	86.5	58.0	35.6	25.6	20.2	14.5	9.55	6.35	5.19	4.40	2.36
M12V90FT	115	115	115	115	84.0	53.9	38.5	30.3	21.6	14.1	9.33	7.65	6.51	3.52
M12V100FT	150	150	150	150	99.0	58.5	40.9	35.0	25.0	16.5	10.9	8.90	7.56	4.01
M12V105FT	141	141	141	141	91.6	59.4	42.9	34.1	24.6	16.4	10.9	8.90	7.52	3.97
M12V125FT	152	152	152	152	105	72.6	52.9	42.3	31.1	19.6	12.9	10.5	9.00	4.84
M12V155FT	236	225	195	170	122	83.9	63.4	51.9	37.0	24.1	16.3	13.3	11.2	5.91
M12V190FT	210	205	191	178	145	112	84.0	65.0	46.5	30.5	20.3	16.8	14.4	7.80

1.87 Vpc – Discharge in A at 20 °C

Type	3 min	5 min	10 min	15 min	30 min	1 h	1.5 h	2 h	3 h	5 h	8 h	10 h	12 h	24 h
M6V200FT	231	231	231	231	175	115	84.0	66.9	48.6	32.4	22.4	18.3	15.5	8.29
M12V35FT	120	105	77.0	61.2	39.2	24.3	17.0	13.2	9.3	5.92	3.91	3.21	2.73	1.48
M12V50FT	150	133	103	83.0	53.0	31.1	22.3	17.6	12.5	7.93	5.20	4.26	3.61	1.94
M12V60FT	160	143	113	93.3	60.9	37.4	26.9	21.2	15.2	10.0	6.69	5.46	4.63	2.47
M12V90FT	120	120	120	120	87.0	57.4	40.8	32.0	23.1	14.7	9.77	8.03	6.84	3.71
M12V100FT	160	160	160	160	106	62.0	43.4	37.0	26.3	17.4	11.5	9.40	7.99	4.23
M12V105FT	147	147	147	147	97.9	62.6	45.1	35.7	25.8	17.0	11.4	9.34	7.89	4.17
M12V125FT	169	169	169	169	115	78.0	56.5	44.9	33.0	20.8	13.6	11.1	9.48	5.08
M12V155FT	273	260	225	196	136	89.5	67.2	54.8	39.0	25.3	17.1	14.0	11.7	6.18
M12V190FT	270	260	237	216	165	118	89.0	68.0	47.9	31.6	21.4	17.8	15.2	8.22

Marathon M-FT

Constant current discharge

1.85 Vpc – Discharge in A at 20 °C

Type	3 min	5 min	10 min	15 min	30 min	1 h	1.5 h	2 h	3 h	5 h	8 h	10 h	12 h	24 h
M6V200FT	345	325	283	250	186	122	88.3	70.1	50.6	33.5	23.0	18.9	16.0	8.54
M12V35FT	128	109	80.0	63.5	40.9	25.3	17.7	13.8	9.6	6.13	4.04	3.32	2.82	1.52
M12V50FT	160	140	108	87.0	55.5	32.2	23.1	18.2	12.9	8.20	5.38	4.41	3.74	2.01
M12V60FT	170	152	118	97.0	62.9	38.5	27.7	21.8	15.7	10.3	6.92	5.65	4.78	2.54
M12V90FT	207	189	150	126	90.0	59.5	42.3	33.2	23.5	15.1	10.0	8.28	7.07	3.87
M12V100FT	265	245	200	168	110	64.0	44.8	38.3	27.1	17.9	11.8	9.60	8.16	4.32
M12V105FT	265	240	191	154	101	64.7	46.5	36.9	26.5	17.5	11.7	9.59	8.12	4.32
M12V125FT	175	175	175	175	119	79.1	57.9	46.4	34.3	21.6	14.1	11.5	9.80	5.24
M12V155FT	324	290	245	210	147	92.8	69.6	56.8	40.3	26.1	17.6	14.3	12.1	6.35
M12V190FT	382	350	293	253	178	122	92.0	70.0	49.3	32.4	22.0	18.3	15.6	8.44

1.83 Vpc – Discharge in A at 20 °C

Type	3 min	5 min	10 min	15 min	30 min	1 h	1.5 h	2 h	3 h	5 h	8 h	10 h	12 h	24 h
M6V200FT	385	360	309	270	197	126	90.8	71.9	51.7	34.2	23.3	19.2	16.3	8.66
M12V35FT	140	118	85.0	66.0	41.8	25.7	18.0	14.0	9.8	6.23	4.11	3.37	2.87	1.55
M12V50FT	170	148	112	90.0	56.5	32.6	23.3	18.4	13.1	8.38	5.48	4.48	3.80	2.03
M12V60FT	180	159	123	100	65.0	39.2	28.2	22.2	15.9	10.5	7.03	5.74	4.85	2.57
M12V90FT	220	200	160	133	92.0	61.0	43.3	34.0	23.9	15.3	10.2	8.40	7.17	3.92
M12V100FT	300	270	213	177	114	66.0	46.2	39.5	27.7	18.1	12.0	9.80	8.33	4.41
M12V105FT	295	260	200	163	104	66.3	47.6	37.7	27.1	17.9	12.0	9.79	8.28	4.40
M12V125FT	186	186	186	186	124	81.7	59.6	47.7	35.2	22.1	14.4	11.8	10.0	5.34
M12V155FT	355	315	257	220	154	95.8	71.5	58.1	41.2	26.7	17.9	14.7	12.3	6.50
M12V190FT	420	381	312	266	186	123	92.0	71.5	50.7	33.2	22.5	18.6	15.9	8.54

1.80 Vpc – Discharge in A at 20 °C

Type	3 min	5 min	10 min	15 min	30 min	1 h	1.5 h	2 h	3 h	5 h	8 h	10 h	12 h	24 h
M6V200FT	425	395	335	290	208	132	95.1	75.1	53.8	35.3	24.0	19.9	16.8	8.90
M12V35FT	150	125	88.0	68.5	42.5	26.3	18.4	14.2	10.0	6.38	4.21	3.46	2.94	1.58
M12V50FT	180	155	116	93.0	58.5	33.5	23.8	18.7	13.2	8.64	5.66	4.68	3.89	2.05
M12V60FT	188	165	127	103	66.4	39.6	28.5	22.5	16.3	10.8	7.21	5.87	4.96	2.62
M12V90FT	237	215	171	140	94.0	63.0	44.7	35.0	24.5	15.7	10.4	8.57	7.31	3.99
M12V100FT	338	300	230	188	118	67.5	47.2	40.3	28.2	18.4	12.2	10.0	8.50	4.50
M12V105FT	320	280	214	170	109	68.3	49.0	38.7	27.8	18.3	12.2	10.0	8.47	4.48
M12V125FT	204	204	204	204	132	85.1	61.8	49.2	36.3	22.8	14.8	12.1	10.3	5.46
M12V155FT	385	340	270	230	161	99.8	73.8	59.6	42.2	28.0	18.9	15.5	12.6	6.64
M12V190FT	458	410	330	278	193	125	93.0	73.0	52.0	33.9	22.9	19.0	16.3	8.70

1.78 Vpc – Discharge in A at 20 °C

Type	3 min	5 min	10 min	15 min	30 min	1 h	1.5 h	2 h	3 h	5 h	8 h	10 h	12 h	24 h
M6V200FT	475	435	362	309	216	134	96.5	76.3	54.6	35.7	24.2	20.0	16.9	8.95
M12V35FT	160	130	90.0	70.0	43.2	26.4	18.4	14.3	10.0	6.42	4.24	3.48	2.97	1.61
M12V50FT	190	162	119	95.0	59.2	33.8	24.0	18.8	13.3	8.70	5.70	4.68	3.92	2.06
M12V60FT	195	170	130	105	67.9	39.6	28.6	22.7	16.7	10.8	7.26	5.91	5.00	2.64
M12V90FT	265	233	179	144	96.0	63.6	45.0	35.2	24.7	15.8	10.4	8.62	7.35	4.01
M12V100FT	370	320	243	195	121	69.0	48.3	40.9	28.7	18.7	12.4	10.2	8.67	4.59
M12V105FT	360	310	230	185	115	69.3	49.7	39.2	28.1	18.5	12.4	10.1	8.57	4.53
M12V125FT	214	214	214	214	136	86.6	62.7	49.8	36.7	23.0	15.0	12.2	10.4	5.53
M12V155FT	410	360	285	240	165	101	74.9	60.3	43.0	28.5	19.1	15.6	12.7	6.72
M12V190FT	489	433	346	291	197	128	93.0	74.0	53.0	34.5	23.2	19.2	16.4	8.75

Marathon M-FT

Constant current discharge

1.75 Vpc – Discharge in A at 20 °C

Type	3 min	5 min	10 min	15 min	30 min	1 h	1.5 h	2 h	3 h	5 h	8 h	10 h	12 h	24 h
M6V200FT	515	470	383	323	220	135	97.2	76.9	55.1	36.2	24.5	20.2	17.1	9.04
M12V35FT	175	138	92.0	71.5	43.4	26.4	18.5	14.3	10.1	6.55	4.32	3.53	2.99	1.59
M12V50FT	200	168	122	96.5	59.9	34.2	24.3	19.0	13.5	8.82	5.77	4.69	3.96	2.08
M12V60FT	200	175	132	107	68.7	40.1	28.9	22.9	16.5	10.9	7.34	5.97	5.05	2.66
M12V90FT	285	248	185	148	98.0	64.0	45.4	35.5	24.9	15.9	10.5	8.68	7.40	4.03
M12V100FT	385	332	250	200	124	70.0	49.0	41.3	29.0	18.9	12.5	10.3	8.75	4.63
M12V105FT	360	310	230	185	115	70.0	50.2	39.7	28.5	18.7	12.6	10.2	8.68	4.55
M12V125FT	233	233	233	233	141	88.1	63.6	50.4	37.1	23.3	15.2	12.4	10.5	5.60
M12V155FT	433	380	300	250	169	103	75.7	60.8	43.5	29.0	19.2	15.7	12.9	6.79
M12V190FT	524	460	363	303	204	130	95.0	76.0	54.5	35.5	23.4	19.3	16.5	8.80

1.73 Vpc – Discharge in A at 20 °C

Type	3 min	5 min	10 min	15 min	30 min	1 h	1.5 h	2 h	3 h	5 h	8 h	10 h	12 h	24 h
M6V200FT	540	490	397	333	223	136	97.9	77.4	55.4	36.5	24.7	20.2	17.1	9.06
M12V35FT	185	145	94.0	72.4	44.0	26.5	18.5	14.3	10.2	6.65	4.34	3.54	3.00	1.60
M12V50FT	210	175	124	98.6	60.7	34.3	24.4	19.1	13.6	8.90	5.79	4.71	3.97	2.08
M12V60FT	205	178	134	108	69.0	40.2	29.0	23.0	16.6	11.0	7.37	6.00	5.06	2.66
M12V90FT	314	265	192	151	100	64.4	45.5	35.6	24.9	15.9	10.5	8.70	7.42	4.04
M12V100FT	400	346	258	204	126	71.0	49.7	41.9	29.3	19.1	12.6	10.4	8.84	4.68
M12V105FT	380	330	240	189	116	70.5	50.6	40.0	28.6	18.8	12.7	10.3	8.71	4.56
M12V125FT	236	236	236	236	143	88.7	64.1	50.8	37.3	23.5	15.3	12.5	10.5	5.63
M12V155FT	465	405	310	258	173	104	76.2	61.2	44.0	29.1	19.3	15.8	12.9	6.80
M12V190FT	563	490	375	312	209	132	96.0	77.0	55.2	35.6	23.5	19.4	16.6	8.86

1.70 Vpc – Discharge in A at 20 °C

Type	3 min	5 min	10 min	15 min	30 min	1 h	1.5 h	2 h	3 h	5 h	8 h	10 h	12 h	24 h
M6V200FT	565	510	407	340	226	137	98.4	77.8	55.7	36.7	24.8	20.3	17.2	9.09
M12V35FT	195	150	95.5	73.8	44.4	26.7	18.6	14.4	10.2	6.68	4.36	3.56	3.02	1.61
M12V50FT	215	179	127	99.7	61.0	34.5	24.5	19.2	13.6	8.94	5.84	4.74	4.00	2.09
M12V60FT	210	182	135	109	69.5	40.4	29.2	23.1	16.7	11.0	7.42	6.03	5.09	2.67
M12V90FT	340	280	200	155	102	64.7	45.7	35.7	25.0	16.0	10.6	8.74	7.45	4.06
M12V100FT	420	360	265	208	127	72.0	50.4	42.4	29.8	19.2	12.8	10.5	8.92	4.72
M12V105FT	410	345	245	193	118	71.2	51.1	40.4	28.8	18.9	12.7	10.3	8.75	4.58
M12V125FT	241	241	241	241	147	89.6	64.6	51.2	37.5	23.7	15.4	12.6	10.6	5.67
M12V155FT	505	430	320	265	176	105	76.9	61.7	44.5	29.2	19.4	15.9	13.0	6.83
M12V190FT	611	520	387	321	213	134	98.0	78.0	56.0	35.7	23.6	19.5	16.7	8.90

1.67 Vpc – Discharge in A at 20 °C

Type	3 min	5 min	10 min	15 min	30 min	1 h	1.5 h	2 h	3 h	5 h	8 h	10 h	12 h	24 h
M6V200FT	600	535	422	348	228	138	99.1	78.2	56.0	36.9	25.0	20.5	17.3	9.12
M12V35FT	205	156	97.0	74.9	44.8	26.8	18.7	14.5	10.3	6.72	4.39	3.58	3.03	1.61
M12V50FT	220	183	129	101	61.7	34.7	24.6	19.3	13.7	9.00	5.89	4.77	4.02	2.10
M12V60FT	214	184	137	110	69.9	40.7	29.4	23.2	16.8	11.1	7.46	6.06	5.12	2.68
M12V90FT	365	300	210	160	105	64.9	45.9	35.9	25.2	16.1	10.6	8.77	7.48	4.07
M12V100FT	440	375	271	211	129	73.0	51.1	42.8	30.1	19.4	12.9	10.6	9.01	4.77
M12V105FT	430	360	250	196	119	72.0	51.6	40.7	29.1	19.0	12.8	10.4	8.79	4.59
M12V125FT	248	248	248	248	150	90.6	65.2	51.7	37.6	23.9	15.5	12.7	10.7	5.72
M12V155FT	530	450	330	270	179	106	77.6	62.2	44.8	29.3	19.5	16.0	13.1	6.86
M12V190FT	641	545	399	327	216	136	99.0	78.6	56.2	35.8	23.7	19.6	16.8	8.95

Marathon M-FT

Constant current discharge

1.65 Vpc – Discharge in A at 20 °C

Type	3 min	5 min	10 min	15 min	30 min	1 h	1.5 h	2 h	3 h	5 h	8 h	10 h	12 h	24 h
M6V200FT	640	560	435	357	231	139	99.8	78.6	56.3	36.9	25.0	20.5	17.3	9.14
M12V35FT	215	158	98.0	75.5	45.0	26.9	18.7	14.5	10.3	6.75	4.40	3.59	3.04	1.62
M12V50FT	225	186	131	102	62.0	34.9	24.7	19.3	13.8	9.08	5.92	4.80	4.04	2.11
M12V60FT	216	186	139	111	70.4	40.8	29.4	23.3	16.8	11.1	7.49	6.09	5.13	2.69
M12V90FT	390	315	215	165	108	65.1	46.0	36.0	25.2	16.1	10.6	8.79	7.49	4.08
M12V100FT	470	400	280	215	130	74.0	51.8	43.1	30.3	19.6	13.0	10.7	9.09	4.81
M12V105FT	445	370	258	197	120	72.6	52.0	41.0	29.2	19.0	12.9	10.4	8.82	4.60
M12V125FT	250	250	250	250	152	91.2	65.7	52.0	37.7	24.0	15.6	12.7	10.8	5.75
M12V155FT	555	470	340	274	180	106	78.0	62.5	45.0	29.4	19.7	16.1	13.1	6.88
M12V190FT	672	569	411	332	217	138	101	79.2	56.4	36.0	23.8	19.7	16.9	8.96

1.60 Vpc – Discharge in A at 20 °C

Type	3 min	5 min	10 min	15 min	30 min	1 h	1.5 h	2 h	3 h	5 h	8 h	10 h	12 h	24 h
M6V200FT	680	590	450	365	233	139	99.7	78.6	56.3	36.9	25.0	20.5	17.3	9.14
M12V35FT	223	163	100	75.5	45.1	27.0	18.7	14.5	10.3	6.75	4.40	3.59	3.04	1.62
M12V50FT	230	190	133	104	62.5	34.9	24.7	19.4	13.8	9.08	5.92	4.80	4.04	2.11
M12V60FT	218	187	140	112	70.4	40.8	29.4	23.3	16.9	11.2	7.49	6.09	5.13	2.69
M12V90FT	400	330	220	170	110	65.1	46.0	36.0	25.2	16.1	10.6	8.79	7.49	4.09
M12V100FT	502	430	295	219	132	75.0	52.5	43.5	30.5	19.7	13.1	10.7	9.09	4.81
M12V105FT	460	380	260	201	122	73.4	52.0	41.0	29.2	19.0	12.9	10.4	8.82	4.60
M12V125FT	250	250	250	250	152	91.2	65.7	52.0	37.7	24.0	15.6	12.7	10.8	5.75
M12V155FT	600	495	350	277	181	106	78.0	62.5	45.3	29.6	19.8	16.2	13.1	6.88
M12V190FT	725	598	423	335	219	140	102	80.0	56.5	36.2	23.9	19.8	16.9	8.96



Marathon M-FT

Constant power discharge

1.94 Vpc – Discharge in W/block at 20 °C

Type	3 min	5 min	10 min	15 min	30 min	1 h	1.5 h	2 h	3 h	5 h	8 h	10 h	12 h	24 h
M6V200FT	1030	1030	1030	1030	804	551	416	341	247	164	112	91.9	77.8	41.3
M12V35FT	807	733	576	478	336	231	165	130	92.5	59.8	40.0	33.0	28.3	15.6
M12V50FT	1280	1164	851	706	458	311	232	184	129	82.5	54.6	44.9	38.3	20.8
M12V60FT	1327	1222	953	765	522	365	265	211	153	102	67.5	55.0	46.6	24.6
M12V90FT	1180	1180	1180	1180	870	562	407	324	235	156	103	84.5	71.5	37.9
M12V100FT	1450	1450	1450	1450	1035	670	469	384	270	172	115	93.5	79.4	41.1
M12V105FT	1250	1250	1250	1250	968	612	443	352	255	170	112	91.8	78.0	41.9
M12V125FT	1159	1159	1159	1159	1159	729	533	427	312	210	146	118	99.7	51.8
M12V155FT	1950	1850	1600	1337	1100	862	649	530	385	257	174	142	121	64.6
M12V190FT	1578	1631	1631	1631	1571	1077	805	680	520	335	222	183	155	89.0

1.92 Vpc – Discharge in W/block at 20 °C

Type	3 min	5 min	10 min	15 min	30 min	1 h	1.5 h	2 h	3 h	5 h	8 h	10 h	12 h	24 h
M6V200FT	1110	1110	1110	1110	857	585	443	363	262	173	118	96.9	82.1	43.8
M12V35FT	943	835	643	531	359	247	176	139	99.3	63.4	42.4	35.0	29.9	16.5
M12V50FT	1417	1273	918	761	487	331	245	196	137	87.4	55.7	47.4	40.3	21.9
M12V60FT	1417	1296	1023	825	559	392	283	224	162	107	71.8	58.5	49.4	26.1
M12V90FT	1290	1290	1290	1290	944	596	430	342	247	164	109	88.9	75.2	39.8
M12V100FT	1500	1500	1500	1500	1100	700	490	407	285	180	120	98.0	83.3	43.1
M12V105FT	1526	1526	1526	1526	1025	651	470	373	269	180	118	97.0	82.4	44.2
M12V125FT	1237	1237	1237	1237	1237	778	567	453	330	222	155	125	105	54.8
M12V155FT	2480	2300	2000	1626	1300	916	684	556	403	269	184	150	127	67.9
M12V190FT	1919	1984	1984	1984	1679	1170	870	765	565	370	245	200	169	93.0

1.90 Vpc – Discharge in W/block at 20 °C

Type	3 min	5 min	10 min	15 min	30 min	1 h	1.5 h	2 h	3 h	5 h	8 h	10 h	12 h	24 h
M6V200FT	1200	1200	1200	1200	920	620	470	386	277	182	125	102	86.6	46.0
M12V35FT	1098	954	718	579	382	262	187	147	104	67.0	44.7	36.9	31.6	17.4
M12V50FT	1619	1436	1003	814	518	351	259	208	145	92.3	60.8	49.9	42.4	22.9
M12V60FT	1676	1493	1124	894	599	420	301	238	171	112	76.1	61.9	52.3	27.6
M12V90FT	1360	1360	1360	1360	990	630	454	359	259	171	114	93.4	78.9	41.6
M12V100FT	1670	1670	1670	1670	1186	740	518	429	300	189	126	103	87.5	45.3
M12V105FT	1600	1600	1600	1600	1085	690	497	393	283	187	125	102	86.8	46.4
M12V125FT	1321	1321	1321	1321	1321	828	601	479	348	233	164	133	111	57.8
M12V155FT	2755	2550	2300	1916	1480	975	718	579	419	282	194	159	134	71.2
M12V190FT	2261	2338	2338	2338	1780	1243	950	785	585	385	256	208	177	97.0

1.87 Vpc – Discharge in W/block at 20 °C

Type	3 min	5 min	10 min	15 min	30 min	1 h	1.5 h	2 h	3 h	5 h	8 h	10 h	12 h	24 h
M6V200FT	1320	1320	1320	1320	1006	664	502	411	294	193	130	107	91.2	48.4
M12V35FT	1242	1060	778	618	402	277	198	155	109.0	70.5	46.9	38.7	33.0	18.1
M12V50FT	1717	1503	1040	838	541	371	270	214	152	96.7	63.5	52.0	44.2	23.7
M12V60FT	1829	1627	1215	950	621	444	318	251	180	118	79.8	64.9	54.8	28.9
M12V90FT	1430	1430	1430	1430	1035	665	477	377	271	178	119	97.6	82.4	43.4
M12V100FT	1790	1790	1790	1790	1250	770	539	447	310	195	130	106	90.3	46.7
M12V105FT	1670	1670	1670	1670	1144	722	519	410	295	194	130	106	90.5	48.3
M12V125FT	1400	1400	1400	1400	1400	873	634	504	366	244	168	139	117	60.6
M12V155FT	3100	2960	2550	2200	1600	1042	758	605	448	300	202	165	140	74.1
M12V190FT	2596	2684	2684	2684	1907	1270	980	810	600	394	263	214	181	100

Marathon M-FT

Constant power discharge

1.85 Vpc – Discharge in W/block at 20 °C

Type	3 min	5 min	10 min	15 min	30 min	1 h	1.5 h	2 h	3 h	5 h	8 h	10 h	12 h	24 h
M6V200FT	1920	1820	1600	1420	1060	692	522	427	305	199	134	111	94.0	49.8
M12V35FT	1309	1109	809	644	419	288	205	161	113	72.8	48.4	39.9	34.0	18.6
M12V50FT	1809	1576	1079	879	564	387	276	217	155	101	66.0	53.6	45.3	23.8
M12V60FT	1931	1721	1265	979	638	449	324	257	185	122	82.3	66.9	56.5	29.7
M12V90FT	2280	2080	1730	1480	1060	689	493	389	279	183	123	100	84.8	44.6
M12V100FT	3100	2800	2220	1880	1295	790	553	455	320	201	133	109	92.6	47.9
M12V105FT	2989	2700	2090	1720	1185	743	533	422	303	199	134	109	93.0	49.6
M12V125FT	2114	2114	2114	2114	1454	905	655	521	377	251	172	144	121	62.4
M12V155FT	3500	3200	2700	2350	1717	1083	786	626	462	309	207	170	143	75.9
M12V190FT	4065	3900	3275	2835	1979	1292	1000	830	610	400	266	217	185	102

1.83 Vpc – Discharge in W/block at 20 °C

Type	3 min	5 min	10 min	15 min	30 min	1 h	1.5 h	2 h	3 h	5 h	8 h	10 h	12 h	24 h
M6V200FT	2070	1950	1700	1500	1100	712	535	437	311	203	138	112	95.3	50.6
M12V35FT	1433	1206	865	677	433	292	208	163	115	73.8	49.1	40.4	34.5	18.9
M12V50FT	1922	1669	1131	914	578	396	281	221	157	102	67.2	54.2	45.8	23.8
M12V60FT	2031	1790	1314	1008	662	458	330	261	188	124	83.6	67.9	57.3	30.1
M12V90FT	2430	2200	1820	1550	1090	700	501	395	282	185	124	101	85.8	45.2
M12V100FT	3300	2980	2350	1960	1329	800	560	465	328	207	137	112	95.2	49.2
M12V105FT	3121	2810	2200	1800	1216	760	545	431	309	203	137	112	95.0	50.3
M12V125FT	2178	2178	2178	2178	1489	924	669	532	385	256	176	148	124	63.4
M12V155FT	3850	3400	2850	2450	1770	1112	805	645	475	315	211	173	146	77.3
M12V190FT	4380	4100	3460	2960	2041	1380	1020	845	615	404	270	221	187	103

1.80 Vpc – Discharge in W/block at 20 °C

Type	3 min	5 min	10 min	15 min	30 min	1 h	1.5 h	2 h	3 h	5 h	8 h	10 h	12 h	24 h
M6V200FT	2327	2160	1840	1605	1165	749	558	453	322	209	142	116	98.2	51.9
M12V35FT	1507	1264	894	700	447	299	213	167	117	75.4	50.1	41.3	35.2	19.2
M12V50FT	1998	1728	1166	933	592	407	289	227	161	104	68.8	55.5	46.6	23.9
M12V60FT	2095	1836	1344	1030	675	472	339	268	192	127	85.5	69.5	58.6	30.7
M12V90FT	2600	2330	1890	1600	1110	717	512	403	288	188	127	103	87.3	46.0
M12V100FT	3621	3224	2459	2011	1355	815	570	473	334	210	140	114	96.9	50.1
M12V105FT	3313	2950	2250	1840	1249	780	558	441	316	207	140	114	96.9	51.2
M12V125FT	2255	2255	2255	2255	1532	949	686	545	394	262	179	151	127	64.8
M12V155FT	4100	3650	3000	2530	1820	1148	829	658	485	320	216	177	149	78.8
M12V190FT	4730	4350	3630	3089	2093	1450	1080	850	620	408	272	223	189	105

1.78 Vpc – Discharge in W/block at 20 °C

Type	3 min	5 min	10 min	15 min	30 min	1 h	1.5 h	2 h	3 h	5 h	8 h	10 h	12 h	24 h
M6V200FT	2460	2270	1910	1660	1193	760	565	457	325	211	143	117	98.9	52.2
M12V35FT	1591	1312	923	721	458	301	214	168	118	76.0	50.5	41.6	35.5	19.4
M12V50FT	2088	1800	1202	956	607	409	290	228	162	105	69.1	55.7	46.8	24.0
M12V60FT	2157	1880	1370	1053	691	476	341	270	193	127	86.0	69.9	58.9	30.9
M12V90FT	2910	2570	2000	1650	1130	721	514	404	290	189	128	104	87.9	46.3
M12V100FT	3777	3355	2568	2100	1380	825	577	479	338	212	142	116	98.6	51.0
M12V105FT	3456	3070	2350	1900	1272	789	565	446	319	210	142	115	98.0	51.7
M12V125FT	2291	2291	2291	2291	1552	960	694	551	398	264	181	153	128	65.6
M12V155FT	4350	3900	3120	2600	1860	1166	841	668	493	325	218	178	151	79.6
M12V190FT	5046	4641	3720	3138	2115	1480	1100	875	625	411	274	225	190	105

Marathon M-FT

Constant power discharge

1.75 Vpc – Discharge in W/block at 20 °C

Type	3 min	5 min	10 min	15 min	30 min	1 h	1.5 h	2 h	3 h	5 h	8 h	10 h	12 h	24 h
M6V200FT	2590	2385	1975	1700	1218	773	572	462	327	213	144	118	99.8	52.6
M12V35FT	1720	1380	950	742	467	304	216	170	119	76.8	51.0	42.0	35.9	19.6
M12V50FT	2174	1848	1233	978	618	412	293	229	163	106	69.6	56.1	47.0	24.0
M12V60FT	2184	1911	1392	1073	701	482	345	272	195	128	86.8	70.5	59.4	31.1
M12V90FT	3200	2780	2080	1690	1150	728	516	405	290	190	129	105	88.9	46.7
M12V100FT	3948	3497	2689	2153	1400	835	584	485	342	215	144	117	99.4	51.4
M12V105FT	3612	3200	2460	1970	1292	796	570	450	322	211	143	116	98.8	52.0
M12V125FT	2307	2307	2307	2307	1562	966	697	553	399	266	183	155	130	66.2
M12V155FT	4550	4070	3250	2659	1890	1171	847	673	500	330	220	180	152	80.3
M12V190FT	5278	4900	3900	3227	2154	1500	1120	885	630	414	276	227	192	106

1.73 Vpc – Discharge in W/block at 20 °C

Type	3 min	5 min	10 min	15 min	30 min	1 h	1.5 h	2 h	3 h	5 h	8 h	10 h	12 h	24 h
M6V200FT	2770	2520	2040	1735	1242	782	577	465	329	214	145	118	100	52.7
M12V35FT	1794	1448	981	760	476	305	217	170	120	77.0	51.2	42.2	36.0	19.7
M12V50FT	2252	1920	1266	1005	632	413	293	230	163	106	69.8	56.2	47.1	24.0
M12V60FT	2263	1962	1420	1093	710	483	346	273	196	128	87.0	70.6	59.6	31.2
M12V90FT	3350	2900	2125	1720	1160	732	518	405	291	191	129	105	89.0	46.8
M12V100FT	4153	3661	2770	2219	1425	845	591	488	345	218	145	118	100	52.1
M12V105FT	3800	3350	2530	2030	1304	800	572	451	323	212	144	117	99.0	52.1
M12V125FT	2324	2324	2324	2324	1573	970	699	554	400	267	183	155	130	66.5
M12V155FT	4850	4300	3330	2720	1910	1177	853	679	508	332	221	180	152	80.7
M12V190FT	5626	5275	4144	3340	2196	1525	1140	900	635	416	278	228	193	106

1.70 Vpc – Discharge in W/block at 20 °C

Type	3 min	5 min	10 min	15 min	30 min	1 h	1.5 h	2 h	3 h	5 h	8 h	10 h	12 h	24 h
M6V200FT	2960	2650	2100	1770	1255	790	581	467	330	214	145	118	100	52.9
M12V35FT	1891	1496	1005	788	478	308	219	172	120	77.5	51.4	42.3	36.1	19.7
M12V50FT	2305	1958	1294	1025	643	414	294	231	164	106	70.1	56.4	47.3	24.1
M12V60FT	2315	1999	1454	1120	721	485	348	274	196	129	87.3	70.9	59.8	31.3
M12V90FT	3500	3000	2170	1750	1170	735	519	406	292	192	129	105	89.1	46.9
M12V100FT	4372	3830	2830	2250	1434	855	598	495	350	221	146	119	101	52.6
M12V105FT	4000	3551	2650	2100	1312	803	575	453	324	213	144	117	99.3	52.2
M12V125FT	2340	2340	2340	2340	1582	974	701	555	400	268	185	155	130	66.9
M12V155FT	5200	4600	3380	2770	1935	1183	857	685	515	334	222	180	153	80.9
M12V190FT	5900	5454	4240	3400	2216	1550	1160	906	640	418	279	229	194	107

1.67 Vpc – Discharge in W/block at 20 °C

Type	3 min	5 min	10 min	15 min	30 min	1 h	1.5 h	2 h	3 h	5 h	8 h	10 h	12 h	24 h
M6V200FT	3100	2750	2150	1800	1270	799	585	469	331	215	145	119	100	53.1
M12V35FT	1993	1560	1037	806	482	309	220	173	121	77.9	51.7	42.5	36.3	19.8
M12V50FT	2365	2004	1317	1042	652	416	295	232	165	107	70.5	56.7	47.4	24.1
M12V60FT	2375	2044	1475	1136	730	487	349	275	196	130	87.6	71.1	60.0	31.3
M12V90FT	3640	3080	2200	1780	1180	737	521	407	292	192	129	105	89.3	47.0
M12V100FT	4645	4011	2890	2280	1443	860	602	499	355	224	147	120	102	52.9
M12V105FT	4250	3670	2730	2140	1321	806	577	455	325	213	145	117	99.6	52.4
M12V125FT	2357	2357	2357	2357	1591	978	703	557	401	268	185	156	131	67.3
M12V155FT	5300	4680	3420	2830	1950	1189	862	690	516	335	222	181	153	81.0
M12V190FT	6148	5696	4367	3470	2234	1580	1180	912	645	420	281	231	195	107

Marathon M-FT

Constant power discharge

1.65 Vpc – Discharge in W/block at 20 °C

Type	3 min	5 min	10 min	15 min	30 min	1 h	1.5 h	2 h	3 h	5 h	8 h	10 h	12 h	24 h
M6V200FT	3200	2850	2200	1835	1285	805	588	471	332	216	146	119	101	53.2
M12V35FT	2067	1595	1064	810	485	309	221	174	122	78.1	51.8	42.6	36.3	19.8
M12V50FT	2416	2039	1337	1060	659	416	296	232	165	107	70.7	56.8	47.5	24.1
M12V60FT	2426	2089	1500	1157	739	489	350	276	197	130	87.8	71.3	60.1	31.4
M12V90FT	3800	3190	2250	1800	1190	739	522	408	293	193	130	105	89.3	47.0
M12V100FT	4924	4153	2950	2310	1449	865	605	502	359	227	149	122	103	53.6
M12V105FT	4505	3800	2770	2160	1326	809	579	456	326	214	145	118	99.8	52.5
M12V125FT	2373	2373	2373	2373	1599	981	705	557	403	269	186	157	131	67.6
M12V155FT	5500	4800	3470	2850	1960	1196	865	695	517	337	223	182	153	81.3
M12V190FT	6380	5938	4480	3519	2245	1600	1200	920	650	423	283	232	196	108

1.60 Vpc – Discharge in W/block at 20 °C

Type	3 min	5 min	10 min	15 min	30 min	1 h	1.5 h	2 h	3 h	5 h	8 h	10 h	12 h	24 h
M6V200FT	3360	2950	2250	1850	1295	805	588	471	332	216	146	119	101	53.2
M12V35FT	2134	1633	1089	820	490	310	221	174	122	78.2	51.8	42.7	36.3	19.9
M12V50FT	2458	2064	1356	1076	670	417	296	233	167	108	70.7	56.8	47.5	24.2
M12V60FT	2467	2131	1523	1175	746	489	350	276	197	131	87.8	71.3	60.1	31.4
M12V90FT	3900	3290	2300	1820	1200	739	522	408	293	193	130	105	89.3	47.0
M12V100FT	5200	4300	3000	2345	1451	870	609	505	364	230	150	122	104	53.9
M12V105FT	4900	3960	2795	2180	1326	809	579	456	326	214	145	118	99.8	52.5
M12V125FT	2373	2373	2373	2373	1599	981	705	557	403	269	186	157	131	67.6
M12V155FT	5750	5000	3500	2870	1970	1196	865	700	518	339	223	182	153	81.3
M12V190FT	6600	6200	4600	3650	2300	1620	1220	932	655	425	284	233	197	108



Battery Service – Energy Solutions

Keeping your business on the move

GNB® is the Expert

Who could do this job better than the professionals of a company with more than 100 years of experience in battery development, production and application?

Leave the responsibility for the maintenance of your batteries and chargers to the professionals: a GNB service contract provides you with exceptional economic advantages through time savings, cost savings and safety!



Installation of Batteries and Systems for Network Power

- > Development of complete turnkey solutions from the design concept to installation and commissioning.
- > Installation according to legal and safety regulations including CE certification by approved installation technicians.
- > Training and certification of external installation technicians according to CE regulations.

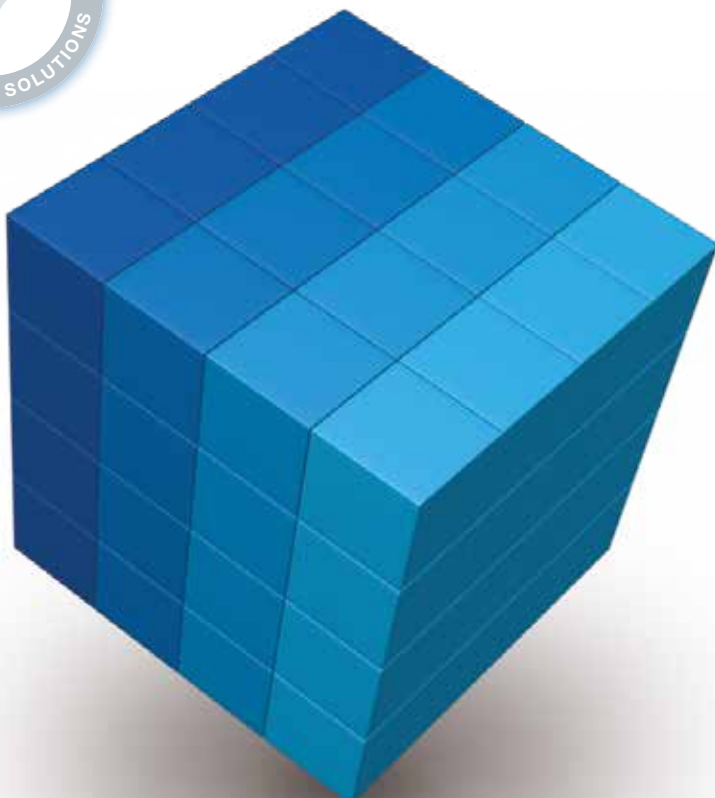

- ✦ Inspection Contract
- ✦ Maintenance Contract
- ✦ Lifetime Warranty Contract
- ✦ Full Service Contract



»GNB Service – individualized, professional and all over Europe!«

Exide Technologies, with operations in more than 80 countries and more than 130 years of experience, is one of the world's largest producers and recyclers of lead-acid batteries. The company develops state-of-the-art energy storage solutions for the automotive and industrial market. Leading car, truck and lift truck manufacturers trust in Exide Technologies as an original equipment supplier. Exide also serves the aftermarket through a portfolio of successful and well-known brands.

Exide Transportation manufactures batteries for light and commercial vehicles, as well as agricultural and marine leisure applications. Industrial markets – under the division **GNB Industrial Power** – include efficient energy storage solutions for motive power applications such as lift trucks, cleaning machines and other commercial electrical vehicles, and network power applications such as telecommunications systems, renewables, and uninterruptible power supply (UPS).

Exide's engineers have always been at the forefront of bringing important innovations to the industry. Exide's ISO/TS-certified manufacturing facilities ensure that customers receive products that are produced with maximum efficiency and fulfill the highest quality standards, while minimizing impact on the environment.

Exide's extensive sales and distribution network provides quality service and delivers on time to its customers. Its world-class recycling facilities ensure that batteries will be reused, helping to make a positive contribution to the environment. Exide also provides services, accessories and energy consulting to its clients.

-  Headquarters
-  Manufacturing plants
-  Recycling plants
-  Distribution centers
-  Main sales offices
-  R&D centres

Manufacturing plants ISO 9001 and ISO 14001 certified
Automotive plants IATF 16949 approved

