

■ Features :

- High efficiency 94% and low power dissipation
- 150% peak load capability
- Built-in active PFC function, PF>0.94
- Protections: Short circuit / Overload / Over voltage / Over temperature
- Cooling by free air convection
- Built-in constant current limiting circuit
- Can be installed on DIN rail TS-35/7.5 or 15
- UL 508(industrial control equipment)approved
- EN61000-6-2(EN50082-2) industrial immunity level
- Built-in DC OK relay contact
- 100% full load burn-in test
- 3 years warranty



**SPECIFICATION**

MODEL		SDR-480-24	SDR-480-48
OUTPUT	DC VOLTAGE	24V	48V
	RATED CURRENT	20A	10A
	CURRENT RANGE	0 ~ 20A	0 ~ 10A
	RATED POWER	480W	480W
	PEAK CURRENT	30A	15A
	PEAK POWER <small>Note.6</small>	720W (3sec.)	
	RIPPLE & NOISE (max.) <small>Note.2</small>	100mVp-p	120mVp-p
	VOLTAGE ADJ. RANGE	24 ~ 28V	48 ~ 55V
	VOLTAGE TOLERANCE <small>Note.3</small>	±1.2%	±1.0%
	LINE REGULATION	±0.5%	±0.5%
	LOAD REGULATION	±1.0%	±1.0%
	SETUP, RISE TIME	1500ms, 150ms/230VAC	3000ms, 150ms/115VAC at full load
HOLD UP TIME (Typ.)	14ms/230VAC at full load		
INPUT	VOLTAGE RANGE <small>Note.7</small>	90 ~ 264VAC	127 ~ 370VDC
	FREQUENCY RANGE	47 ~ 63Hz	
	POWER FACTOR (Typ.)	0.94/230VAC	0.99/115VAC at full load
	EFFICIENCY (Typ.)	94%	
	AC CURRENT (Typ.)	5A/115VAC	2.5A/230VAC
	INRUSH CURRENT (Typ.)	40A/115VAC	80A/230VAC
	LEAKAGE CURRENT	<0.8mA / 240VAC	
PROTECTION	OVERLOAD	Normally works within 110 ~ 150% rated output power for more than 3 seconds and then shut down o/p voltage with auto-recovery >150% rated power, constant current limiting with auto-recovery within 2 seconds and may cause to shut down if over 2 seconds	
	OVER VOLTAGE	29 ~ 33V	56 ~ 65V
	OVER TEMPERATURE	105°C ±5°C (T <sub>SW</sub> : detect on heatsink of power switch) Protection type : Shut down o/p voltage, recovers automatically after temperature goes down	
FUNCTION	DC OK RELAY CONTACT RATINGS (max.)	60Vdc/0.3A, 30Vdc/1A, 30Vac/0.5A resistive load	
ENVIRONMENT	WORKING TEMP. <small>Note.5</small>	-25 ~ +70°C (Refer to "Derating Curve")	
	WORKING HUMIDITY	20 ~ 95% RH non-condensing	
	STORAGE TEMP., HUMIDITY	-40 ~ +85°C, 10 ~ 95% RH	
	TEMP. COEFFICIENT	±0.03%/°C (0 ~ 50°C)	
	VIBRATION	Component:10 ~ 500Hz, 2G 10min./1cycle, 60min. each along X, Y, Z axes; Mounting: Compliance to IEC60068-2-6	
SAFETY & EMC <small>(Note 4)</small>	SAFETY STANDARDS	UL508, TUV EN60950-1 approved	
	WITHSTAND VOLTAGE	I/P-O/P:3KVAC I/P-FG:1.5KVAC O/P-FG:0.5KVAC O/P-DC OK:0.5KVAC	
	ISOLATION RESISTANCE	I/P-O/P, I/P-FG, O/P-FG:>100M Ohms / 500VDC / 25°C / 70% RH	
	EMC EMISSION	Compliance to EN55022 (CISPR22) Class B, EN61000-3-2,-3	
	EMC IMMUNITY	Compliance to EN61000-4-2,3,4,5,6,8,11, EN55024, EN61000-6-2 (EN50082-2), EN61204-3, heavy industry level, criteria A, SEMI F47, GL approved	
OTHERS	MTBF	112.9Khrs min. MIL-HDBK-217F (25°C)	
	DIMENSION	85.5*125.2*128.5mm (W*H*D)	
	PACKING	1.6Kg; 8pcs/13.8Kg/0.9CUFT	
NOTE	<ol style="list-style-type: none"> <li>1. All parameters NOT specially mentioned are measured at 230VAC input, rated load and 25°C of ambient temperature.</li> <li>2. Ripple &amp; noise are measured at 20MHz of bandwidth by using a 12" twisted pair-wire terminated with a 0.1uf &amp; 47uf parallel capacitor.</li> <li>3. Tolerance : includes set up tolerance, line regulation and load regulation.</li> <li>4. The power supply is considered a component which will be installed into a final equipment. The final equipment must be re-confirmed that it still meets EMC directives.</li> <li>5. Installation clearances : 40mm on top, 20mm on the bottom, 5mm on the left and right side are recommended when loaded permanently with full power. In case the adjacent device is a heat source, 15mm clearance is recommended.</li> <li>6. 3 seconds peak power max. and the average output power should not exceed the rate power.</li> <li>7. Derating may be needed under low input voltage. Please check the derating curve for more details.</li> </ol>		

**Mechanical Specification**

Case No.984A Unit:mm

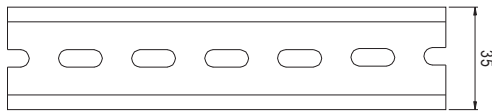
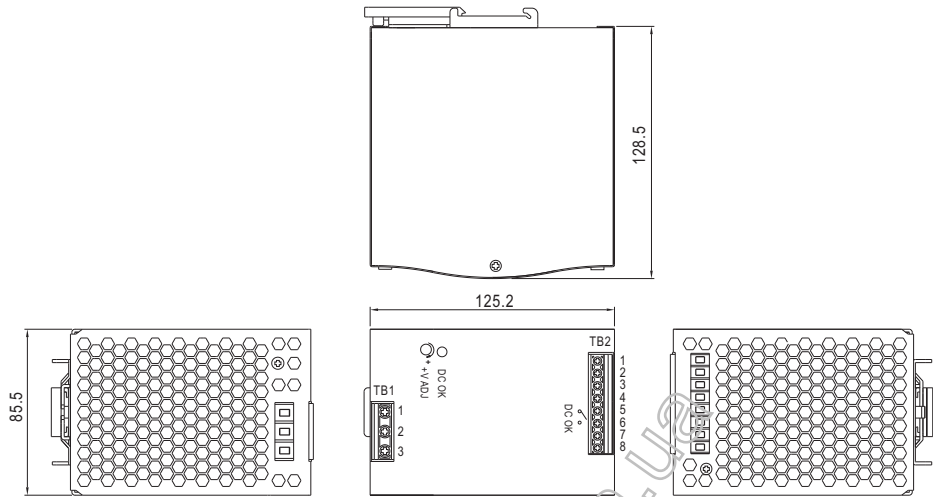

ADMISSIBLE DIN-RAIL: TS35/7.5 OR TS35/15

**Terminal Pin No. Assignment (TB1)**

Pin No.	Assignment
1	FG ⊕
2	AC/N
3	AC/L

**Terminal Pin No. Assignment (TB2)**

Pin No.	Assignment
1,2	DC OUTPUT +V
3,4	DC OUTPUT -V
5,6	Relay Contact
7,8	NC

**Block Diagram**

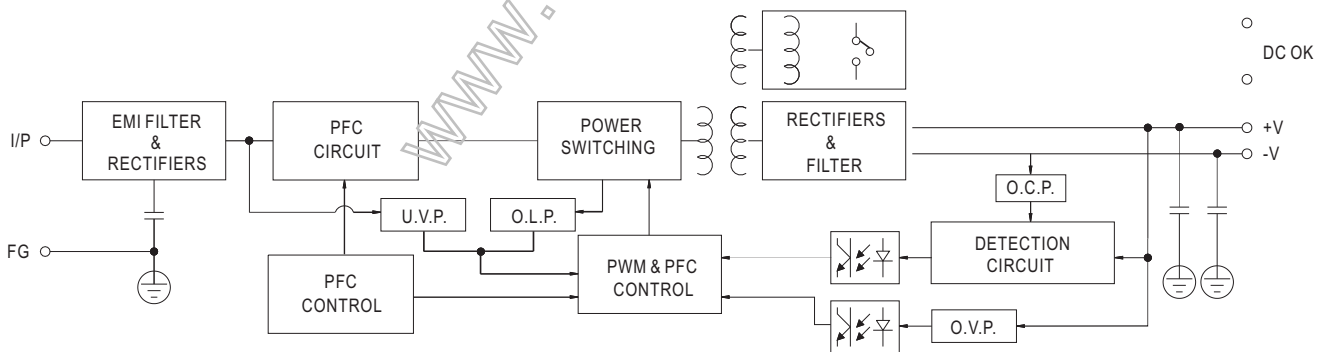

**DC OK Relay Contact**

Contact Close	PSU turns on / DC OK.
Contact Open	PSU turns off / DC Fail.
Contact Ratings (max.)	30V/1A resistive load.

■ Peak Loading

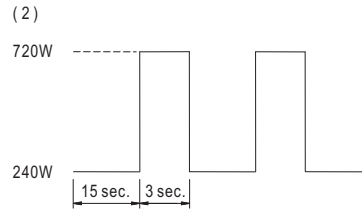
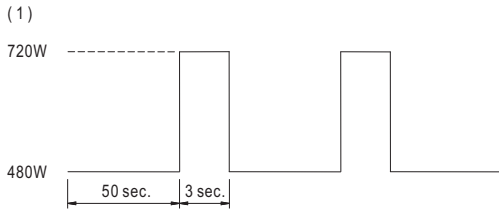

■ Derating Curve

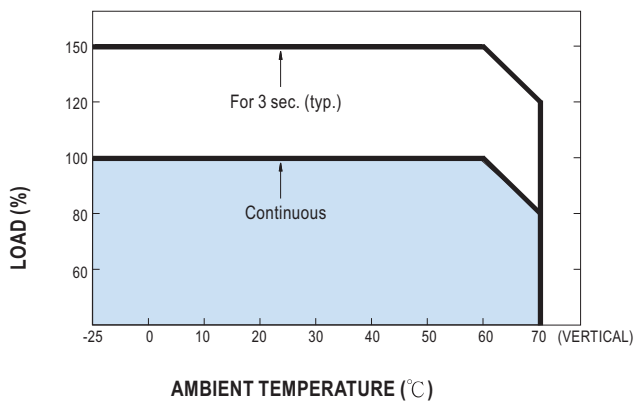

■ Output derating VS input voltage

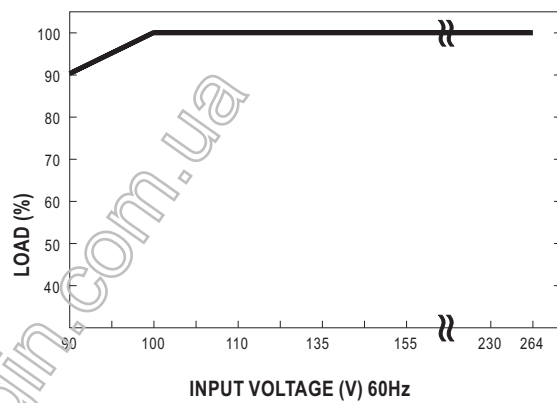

www.sv-engine.com.ua