

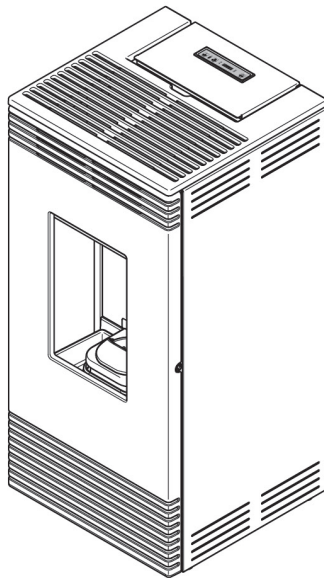

EN

**DIRECTIONS FOR INSTALLATION
USE AND MAINTENANCE**



PHILIA 9

**ENVIRONMENT-FRIENDLY PELLET STOVE
WITH FAN-ASSISTED HOT AIR**

**THESE INSTRUCTIONS ARE INTEGRAL PART OF THE PRODUCT
PLEASE READ CAREFULLY AND SAVE FOR FUTURE REFERENCE**

Serial number

Foreword

- **Congratulations on your purchase of a INVICTA product, one of the best available on the market!**
- Before installing and operating your appliance, read this instruction manual carefully and save it for future reference.
- For any installation, electrical connection, inspection, maintenance or repair works, refer to authorized, qualified or experienced technicians only.
- The INVICTA pellet stoves and their claddings are distributed in France through a network of dealers-installers. INVICTA does not allow the installation of its own appliances carried out by private customers.
- It is recommended that the first-time lighting of your appliance should be done by the appliance installer who may check and ensure proper appliance operation and draught.



In order for the appliance to work well without the accumulation of pellet, you are advised to pre-set correctly the combustion parameters for pellet loading (see section 3.3.5 - Menu M8) and to carry out accurate daily cleaning of the burner (see section 4.1.3).

- This appliance is not suitable for people (children included) with reduced physical, sensorial and mental capacities, or unpractised people, unless they are supervised and trained to use the appliance by someone who is responsible for their safety.
- Never let your appliance unattended in the presence of children. Do not let the children touch any hot surface areas of the appliance nor let them operate it.



Overpressure in the combustion chamber preceded by a significant and anomalous presence of smoke without flames is the most serious problem to be monitored closely because it can lead to rupture of the glass or cause the appliance door to burst open with the consequent release of smoke into the room. (Refer also to heading 1.5.2).



If the appliance repeatedly fails to light or in the presence of repeated anomalous generation of copious amounts of smoke with no flame in the combustion chamber, stop using the appliance immediately and have both appliance and flue checked by an authorised technician.

- For any further information or requests always contact an authorized dealer who will be pleased to assist you.

Symbols used in this manual

In the present instruction manual some indications are pointed out by the following symbols:



Safety precautions.



Prohibited operation.



Important information.

INVICTA assumes no responsibility for any incidental or consequential damage to people, things or pets resulting from the inobservance of the prescriptions given in this manual, particularly of those marked with following symbols.



SUMMARY	4
1 GENERAL INFORMATION	4
1.1 Warranty	4
1.1.1 Warranty conditions	4
1.1.2 CE label and product serial number	4
1.1.3 Remarks on materials	5
1.2 Certifications	6
1.2.1 CE marking information	6
1.2.2 Further certifications	7
1.3 Technical dimensions and features	7
1.3.1 Technical drawings stove	7
1.3.2 Technical features	8
1.4 Pellet fuel	9
1.5 Recommendations	10
1.5.1 Safety precautions	10
1.5.2 Warnings for the management of anomalies in the combustion chamber	11
1.5.3 General recommendations	12
1.5.4 Warnings for correct appliance disposal	12
1.6 Safety requirements and devices	13
1.7 Environment requirements	14
1.8 Equipment	15
1.9 Functioning principle	16
2 INSTALLATION	17
2.1 Packaging dismantling and disposal	17
2.2 Installation requirements	17
2.3 Appliance installation	17
2.3.1 Appliance Positioning	17
2.3.2 Outside air intake	19
2.3.3 Flue gases venting into a traditional chimney	19
2.3.4 Smoke outlet into exterior vertical vent (stainless steel lined type)	20
2.3.5 Electrical connection	21
2.3.6 Positioning the room temperature sensor	21
2.3.7 Disassembling the cladding	22
3 OPERATION	23
3.1 Pre- and first-lighting instructions	23
3.2 Pellet loading	23
3.3 Control panel	24
3.3.1 Starting your appliance	24
3.3.2 Switching off	26
3.3.3 Setting maximum operating power	26
3.3.4 Setting ambient temperature	26
3.3.5 Menu	28
3.3.6 Alarm warnings	33
3.3.7 SERVICE signal	35
4 CARE AND MAINTENANCE	36

4.1 Recurrent maintenance	36
4.1.1 Cleaning of display screen and exterior cladding elements	36
4.1.2 Cleaning of ceramic glass	36
4.1.3 Recurrent maintenance of type A	37
4.2 Routine maintenance	39
4.2.1 Routine maintenance of type B	39
4.2.2 Routine maintenance of type C	41
4.2.3 Gasket control	41
4.2.4 Cleaning of vertical venting pipes	41
4.3 Putting your appliance out of service	41
4.4 Failures/ Causes / Trouble-shooting	41
4.4.1 Replacement of fuse in service	43
5 FOR THE AUTHORIZED SERVICE TECHNICIAN	44
5.1 Wiring-diagram	44
5.2 Connection to a thermostat or to a switch	45
5.3 Servicing record	45

1 GENERAL INFORMATION

1.1 Warranty



1.1.1 Warranty conditions

1. INVICTA acknowledges and adopts the "guarantee of conformity with the contract" of Directive 1999/44/CE.
2. As to benefit from the guarantee in compliance with the provisions of national law adopted in order to comply with Directive 1999/44/CE, the consumer shall refer to his dealer only (the seller).
3. As for the restrictions see chapter 1.1.3.

1.1.2 CE label and product serial number

The serial number is printed on the cover of the appliance "installation, use and maintenance" manual. It is highly recommended that the serial number be quoted for any request.

This number is also printed at the bottom of the CE label located on the back side of the unit.

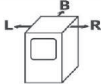
					
N° DOP: 02261				F-08350 DONCHERY - FRANCE	
EN 14785:2006 Notified Laboratory: 0694		PHILIA 9			
N = P.T. Nominale / Nominal T.O. / NW Leistung / P.T. Nominale R = P.T. Minimale / Minimun T.O. / Min. Leistung / P.T. Ridotta					
Puissance Thermique Nominale / Thermal Output WL=Wärmeleistung / Potenza Termica		N	9,0	kW	
		R	3,4		
P.T. utile transférée à l'air / usefuf T.O. to room WL an den Raum / P.T. utile resa all'aria		N	-	kW	
		R	-		
P.T. utile transférée à l'eau / usefuf T.O. to water WL an das Wasser / P.T. utile resa all'acqua		N	-	kW	
		R	-		
Emission CO (mesure à 13% O ₂) / CO emission (at 13% O ₂) CO Emission (bei 13% O ₂) / CO misurato (al 13% di O ₂)		N	≤ 0,02	%	
		R	≤ 0,06		
Valeur moyenne poussières (à 13% O ₂) / Average dust content (at 13% O ₂) Mittlerer Staubgehalt (bei 13% O ₂) / Valore medio polveri (al 13% di O ₂)		N	29,3	mg/m	
		R	-		
Rendement / Efficiency / Wirkungsgrad / Rendimento		N	≥ 85,0	%	
		R	≥ 80,0		
Pression max. de l'eau admise en fonction Max. water pressure admitted during operation / maximaler Betriebsdruck Massima pressione idrica di esercizio ammessa			-	bar	
Puissance électrique nominale / Nominal electrical output Elektrische Nennleistung / Potenza elettrica nominale			390	W	
Tension nominale / Nominal voltage / Nennspannung / Tensione nominale			230	V	
Fréquence nominale / Nominal frequency / Nennfrequenz / Frequenza nominale			50	Hz	
Combustible / Fuel / Brennstoff / Combustibile		GRANULÉS DE BOIS / WOODPELLET HOLZPELLET / PELLETT DI LEGNO			
Distance minimum des matériaux inflammables Minimum distance from inflammable materials Mindestabstand zu brennbaren Materialien Distanza minima da materiali infiammabili				R = 200 mm	
				L = 200 mm	
				B = 200 mm	
LIRE ET SUIVRE LES INSTRUCTIONS D'EMPLOI / READ AND FOLLOW THE USE INSTRUCTIONS BEDIENUNGSANLEITUNGEN LESEN UND BEACHTEN / LEGGERE E SEGUIRE LE ISTRUZIONI D'USO UTILISER SEULEMENT LES COMBUSTIBLES RECOMMANDÉS / USE RECOMMENDED FUELS ONLY AUSSCHLIEßLICH EMPFOHLENE BRENNSTOFFE VERWENDEN / USARE SOLO COMBUSTIBILI RACCOMANDATI CET APPAREIL NE PEUT PAS ÊTRE UTILISÉ SUR UN CONDUIT DE FUMÉE À USAGE COLLECTIF/ THIS APPLIANCE CANNOT BE USED ON A MULTI-FLUE CHIMNEY / DAS GERÄT DARF NICHT AN MEHRFACHBELEGTEM SCHORNSTEIN ANGESCHLOSSEN WERDEN / QUESTO APPARECCHIO NON PUÒ ESSERE USATO SU CANNA FUMARIA CONDIVISA					
N° DE SÉRIE		0000000 000000		SERIAL NO.	
SERIENNUMMER		6420-00		N° DI SERIE	

Example of CE label with serial number

1.1.3 Remarks on materials



The materials used to manufacture this product have been thoroughly checked and are guaranteed to be free from defects.

The components below are subject to common wear and tear (corrosion or progressive decay) that cannot constitute grounds for objection due to the type and features of the materials used in the construction of the parts and due to the product operational conditions.

- The internal movable or fix parts in steel or cast iron: are made of high temperature resistant materials but could distort and settle if using the wrong fuel or exceeding the fuel amount suggested in this manual. However they can eventually present rusty or oxidized parts.
- The burn pots may be subject to high overheating, and with the time can be subject to corrosion and distortion or oxidation.
- Gaskets: are necessary to make the firebox airtight and to hold the ceramic glass panel in place; their distortion absorbency and elasticity will be guaranteed only by following the instructions under section 4.1.2 regarding the ceramic glass cleaning; mind that if the glass detergent trickles down the glass, the gaskets could harden letting the glass panel loose.

Misuse of the following components could result in their breakage.

- The ceramic glass panels: are thoroughly factory-checked. Please note that with the techniques currently available, the manufacturing of glass ceramic panels totally free from any kind of defects cannot be guaranteed and therefore any irregularities that might be noticed have to be considered within the specifications of this material and are not prejudicial to its strength nor to the correct functioning of the firebox. Note: Please refer to section 4.1.2 for directions on cleaning.

1.2 Certifications

1.2.1 CE marking information



CE-MARKING INFORMATION

CE

INVICTA

16

EN 14785:2006

Home-heating appliance fired by wood pellets

PHILIA 9

Security minimum distance from inflammable material	: side 200 back 200
CO-emission in combustion products	: ≤ 0,02 % nominal thermal output ≤ 0,06 % minimum output
Max. water pressure admitted during operation	: bar
Flue gas temperature	: 244,0 °C nominal thermal output 140,0 °C minimum output
Nominal thermal output	: 9,0 kW
Minimal thermal output	: 3,4 kW
Efficiency	: ≥ 85,0 % nominal thermal output ≥ 80,0 % minimum output
Type of fuel	: wood pellets
Nominal power	: 390 W
Nominal voltage	: 230 V
Nominal frequency	: 50 Hz

INVICTA SAS
 Directeur Général
 Cédric Kammerer

INVICTA SAS - Zone Industrielle Lieu dit « la Gravette » - BP03 - 08350 DONCHERY - Tél. 03 24 27 71 71 - Fax 03 24 26 62 42 - Site : www.invicta.fr
 SAS au capital de 5.388.750€ - Code APE 2752Z - RC Sedan 57 B 79 - Siren 685.780.793.00012 - TVA intracommunautaire FR 36.685.780.793

1.2.2 Further certifications

We declare that the appliance
PHILIA 9

complies with legislative provisions that implement the following directives and regulations:

- Directive 2004/108 CE (EMC Electromagnetic Compatibility) and subsequent amendments.
- Directive 2006/42 CE (MD Machinery Directive) and subsequent amendments.
- Directive 2006/95 CE (LVD Low Voltage) and subsequent amendments.
- Regulation (UE) 305/2011 (Building Products).

1.3 Technical dimensions and features

1.3.1 Technical drawings stove

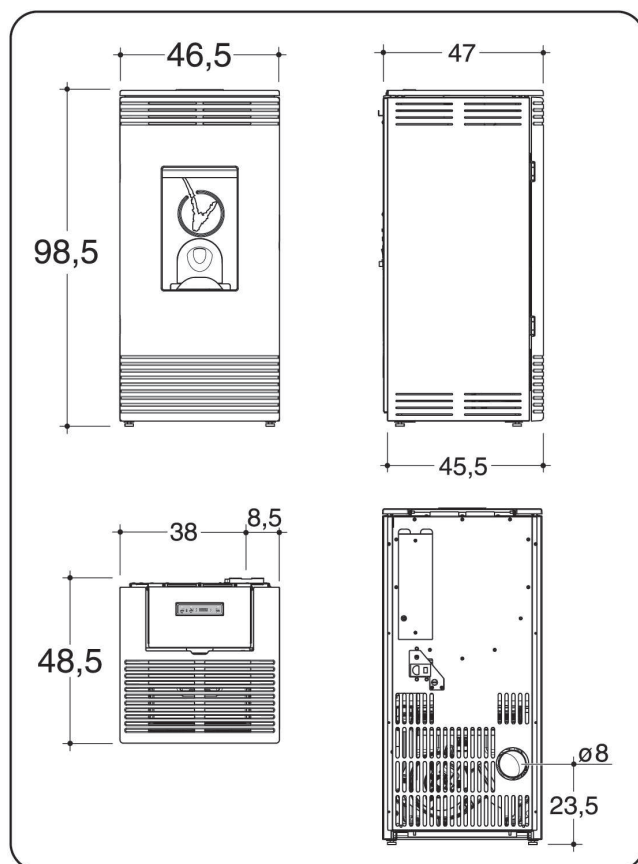
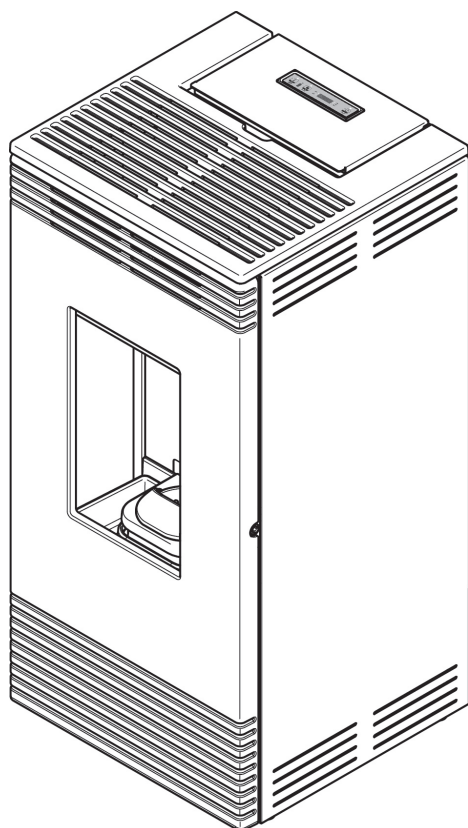

1.3.2 Technical features

Readings in accordance with standard EN 14785:2006	PHILIA 9			
	Output	nominal	minimum	
Thermal Output	9,0	3,4		kW
CO emission at 13% oxygen	≤ 0,02	≤ 0,06		%
efficiency	≥ 85,0	≥ 80,0		%
nominal electrical power	390			W
nominal voltage	230			V
nominal frequency	50			Hz
fuel	wood pellet			
fuel consumption per hour	2,18	0,84		kg/h
total capacity of flue gases	5,7	5,0		g/s
flue gas temperature	244,0	140,0		°C
flue draught pressure	11,5	10		Pa
receptacle capacity	16,5			kg
burn time	7,6	19,6		h
operating power required	76			W
flue gases outlet	Ø 80			mm
combustion air intake	40 x 40			mm
net weight	134			kg
weight with packaging	149			kg
.				

1.4 Pellet fuel

Wood pellets are made through sawdust drawing after processing natural dry wood, whose content of lignin gives compactness to the material and enables to manufacture pellets without using any adhesives or binders.

The section of wood pellets varies from 6 to 12 mm.; the standard length is from 5 to 30 mm.; the density of a high grade pellet fuel varies from 1000 to 1400 kg/cu.m.

i **With this appliance we recommend the exclusive use of pellets of 6 ± 1.0 mm diameter and length $31.5 \leq L \leq 40.0$ mm (EN 14961-2 – Category A1).**

Various types of wood pellets are available on the market and their characteristics depend on the wood mixtures used for their manufacturing.

The pellet fuel produced from natural wood, free of dirt or any other impurities, originally contains an extremely low moisture content, from 6% to 8%, allowing its use without previous seasoning. Mind that the moisture content of pellets can easily change if the fuel is stocked in unsuitable places and that an increase in the moisture content may also increase the size of pellets, which may result in the blockage of the fuel feeding into the burn pot. A rise in the moisture content may also vary the molecular structure of pellets, which may convert into a viscous and low combustible material.

⊘ **It is FORBIDDEN to use fuels other than wood pellet.**

⊘ **The use of pellets manufactured from rejects of semifinished wood products containing binders and paint is FORBIDDEN; these pellets are not included in the category of approved or recommended pellet fuels.**

The heat output of natural pellets can achieve 4600 Kcal/kg and a very high efficiency is ensured when they are used with the suitable appliances.

Pellets are more economical as a fuel than natural gas or oil.

Their smoke emission rate comply with the most stringent European regulations referring to environmental protection, thanks to their peculiar characteristics teamed up with the technical features of this appliance.

Available on the market in 15 kg. bags, pellets can be stocked easily.

i **For the proper and safe operation of this appliance, it is very important that the pellets are stored in a dry place.**

After extensively testing, for the good functioning and efficiency of the appliance INVICTA highly recommends using fuel of good quality.















Pellets must be made from natural wood sawdust only, free from other materials.

⚠ **CAUTION: The use of different fuels (maize, nutshells, etc.), low grade pellets or pellets with different sizes than those we recommend, may cause damages to the appliance component parts thus voiding the warranty granted and releasing the manufacturer from any responsibility.**

⚠ **CAUTION: The use of a pellet which produces lots of combustion residues can make the appliance get dirty more rapidly, thus causing frequent cases of pellet buildup. In such case it is absolutely necessary to reduce the time interval between routine maintenances of type B to no more than 250÷300 hours of use.**

1.5 Recommendations

1.5.1 Safety precautions

-  **IMPORTANT!!!** For the proper and safe operation of this appliance and the electrical components in it, and in order to prevent any possibility of causing serious injury, the instructions given in this manual must always be followed.
-  **CAUTION:** The installation, electrical connection, operation control, repair and maintenance works, must be executed by qualified staff only.
-  **CAUTION:** If there has been a fire in the flue it is necessary to turn the appliance off and call the fire department and check whether the chimney stack and flue pipe have been visibly damaged. Make any repairs before any further use of the combustion system.
-  **CAUTION:** All local, national and European Norms must be met during installation and use of the appliance.
-  **CAUTION:** The accident-prevention and safety requirements stated in this manual must be followed carefully.
-  **CAUTION:** This manual must be read and understood in every part, and the use of the controls must be clear before operating the appliance or executing any works on it.
-  **WARNING:** The appliance operation, controls adjustment and programming must be done by adult persons only. Incorrect operation may cause harm, damage and/or malfunctions.
-  **WARNING:** Do not modify or replace any parts in the unit by yourself; not-authorized works may cause injuries and will relieve INVICTA of any public or criminal liability.
-  **WARNING:** During operation, some of the appliance surface areas may become very hot; we highly recommend not to leave the unit unattended in the presence of children, elderly and disabled people.
-  **Do not touch the glass; the glass provides visibility of the flames and also contributes to the distribution of heat through irradiation, so it reaches very high temperatures.**
-  **CAUTION:** To avoid overheating the appliance with consequential shut-down do not obstruct or cover with any cloth, towel, etc. the warm air outlet.
-  **ATTENTION:** Keep the fuel and inflammable materials at proper distance.
-  **CAUTION:** Leaning or hanging on the opened door imprudently, during cleaning operations, could cause the turnover of the appliance; it is therefore advisable not to do so and to take the necessary precautions especially when children, elderly or disabled people are present.
-  **WARNING:** Never use flammable liquids (alcohol or petrol) to speed up the lighting of a wood fire: it is extremely dangerous. Alcohol and petrol release highly flammable vapours, which could provoke the risk of burns.

1.5.2 Warnings for the management of anomalies in the combustion chamber

 **Strict compliance with all the instructions for installation (in accordance with statutory legislation), use and maintenance given in this manual is sufficient to ensure correct operation of the appliance and avoid potential problems.**

 **Malfunctions, both minor and serious, are frequently primarily caused by failure to comply with one or more of the prescriptions set down in this manual.**

 **Overpressure in the combustion chamber preceded by a significant and anomalous presence of smoke without flames is the most serious problem to be monitored closely because it can lead to rupture of the glass or cause the appliance door to burst open with the consequent release of smoke into the room.**

To avoid this risk, take care to:









- Ensure the burner is always clean before starting the appliance.
- Remove all encrustations and deposits caused by pellets of the incorrect size or of poor quality.
- Empty the burner and clean it thoroughly before attempting to light the appliance after a failed ignition event.
- Never attempt to load pellets into the burner by hand, either before starting the appliance or while it is operating.
- Refit the burner into its location after each maintenance task, removing any residues around the seating surface.
- When the appliance is in operation check for possible pellet accumulations.
- Monitor appliance operation to check for a tendency of the flame to extinguish.
- Remove any accumulations of unburnt pellets in the burner following a failed ignition event or a no pellet alarm, before re-starting the appliance. For safety reasons, never re-load previously removed unburnt pellets into the pellet fuel hopper.

In the presence of pellet accumulations with the anomalous generation of copious smoke without flame, observe the following prescriptions:

- Do not disconnect the appliance from the electrical power supply under any circumstances.
- Do not open the appliance door.
- As a precaution, open the windows of the room in which the appliance is installed in order to provide adequate ventilation.
- Do not stand in front of the appliance. Keep clear of the area until the smoke has been completely dispersed.







 **If the appliance repeatedly fails to light or in the presence of repeated anomalous generation of copious amounts of smoke with no flame in the combustion chamber, stop using the appliance immediately and have both appliance and flue checked by an authorised technician.**

1.5.3 General recommendations

-  CAUTION: This appliance is intended for the use it has been designed and manufactured for only.
-  CAUTION: Do not use this unit as a cooker.
-  ATTENTION: Don't use the appliance as an incinerator.
-  CAUTION: Do not use the appliance in the case of faults or malfunctions, and if these should occur while it is on, switch it off immediately by prolonged pressing of the button [P3] (see section 3.3.2). Only disconnect the appliance from the mains once it has shut down completely (electrical plug disconnected).
-  **In order to avoid releasing smoke in the room, it is FORBIDDEN to operate the appliance with the door open, without the glass panel or with broken glass.**
-  Inspect and clean the exhaust venting system periodically.
-  Do NOT spray the appliance with water to clean any of its parts.
-  For repairing, refer to authorized professionals and ask for original replacement parts only.
-  Keep this instruction manual as an integral part of the product for future reference. It must be supplied together with the unit if this is resold or moved to another place, so as to allow the next user and installer to get acquainted with its operating instructions and requirements. Should the manual be lost or become unreadable, call Caminetti Montegrappa for a new copy.

1.5.4 Warnings for correct appliance disposal

Warnings for correct appliance disposal in accordance with European Directive 2002/96/EC.

-  Responsibility for the demolition and the disposal of the appliance lies exclusively with the owner who will have to act in compliance with the regulations in force in his own Country regarding safety, respect and protection of the environment.
-  At the end of his useful life the appliance cannot be disposed of together with urban refuse. It can be taken to special waste collection centers provided by local government, or to a dealer providing this service.
-  The separate disposal of the appliance (taking it to authorized recycling centres) avoids the possible negative consequences for the environment and human health resulting from inappropriate disposal and allows to recover the materials it is made of, in order to obtain significant energy and resources savings.
-  **WARNING: Improper disposal of the appliance by the user implies the application of administrative sanctions provided by law.**
-  The abandonment of the appliance in accessible areas is a serious danger to humans and animals. The responsibility for any damage to people and animals always lies with the owner.
-  Upon demolition, CE marking, this manual, the declaration of disposal, the manual for installation and other documents relating to this appliance must be preserved. Remember that any registration with the regional land registry should be annulled.

1.6 Safety requirements and devices

The appliance is provided with the following safety devices:

- Sensor for measuring the flue gas temperature: it indicates that ignition has taken place; it switches on the convection fan; it indicates the unprogrammed fire extinction; it stops the smoke exhauster and the convection fan after the programmed fire extinction.
- Sensor for measuring the temperature in the fuel hopper: if it senses the temperature in the pellet hopper to be higher than the preset safety temperature, it will shut down the appliance.
- Switch for controlling the pressure in the exhaust system: cut-off switch operated by the pressure in the exhaust system when it is higher than the preset value; a higher pressure may indicate that the exhaust system is obstructed.



It is FORBIDDEN to disconnect the safety devices.

Once the troubles that activated the safety alarms are eliminated, the appliance can be re-started and operated normally.



IMPORTANT: The appliance must be positioned so as to allow easy access to the plug.



WARNING: The appliance must be connected to an insulated flue of the correct size.



Note: This section has been drawn up considering the appliance as being operated in accordance with the requirements and directions on the appliance use indicated under section 3.

Since INVICTA has no control over the conditions in which the appliance is being operated we assume no responsibility for any injury or damage to people, properties or pets resulting from the non-observance of these instructions and of the following recommendations:

- A) During any maintenance, adjusting, cleaning and servicing works, the appliance must not be left unattended in order to avoid incidental starting by third party.**
- B) Do not mishandle and/or remove any safety devices in the appliance.**
- C) Provide an efficient connection to the exhaust venting system.**
- D) Check that the room where the appliance is installed is aerated as prescribed.**

1.7 Environment requirements



IMPORTANT: To ensure its proper operation, the appliance shall be located in a ventilated room where an air flow allowing the complete combustion of wood can be admitted according to the installation requirements under the local standards currently in force.

The air supply must be sufficient for proper combustion and to provide ventilation of the room, the volume of which cannot be less than 20 cu.m.

The natural admission of air must be provided through a permanent opening made on the exterior wall(s) of the room to be aired (for the minimum section dimensions see section 2.3.2); the outside fresh air intakes must be made in such a way they can never be obstructed (check regularly).

Air entering the room where the appliance is installed from contiguous room(s) is permitted provided it is admitted from a space which is aired directly from outside, a space which is not used as a bedroom or a bathroom and where fire ignition could never occur, as in a garage or in a combustible warehouse, in compliance with the requirements under the local standards currently in force.

40 cu.m/h of air is required in order to ensure proper fuel combustion.



Do NOT install the appliance in a bedroom or a bathroom, or in any other room where an existing heating appliance (fireplace, stove, etc.) is not provided with its own outside air source.



It is FORBIDDEN to install the appliance near objects made of combustible materials (curtains, pieces of furniture, carpets,...).

If the appliance is installed on flooring that may be flammable, a 2 mm thick (minimum) non-flammable floor protector must be laid underneath that is larger than the unit's base (see our price-list).



The appliance is not designed to be operated in environments where materials may explode. Therefore, it is FORBIDDEN the use of the appliance in an explosive atmosphere or in a space where materials or machineries may produce gas or dust emissions in such a quantity they may cause an explosion.



If wall surfaces are not flammable, install appliance at a distance from the back of approx. 10 cm minimum.

If walls have wood paneling or any other flammable surface, there must be 20 cm minimum clearance behind the appliance, and 40 cm to the side. A 150 cm clearance must be maintained from anything, such as furniture, in front of the unit.

It is recommended that particularly delicate objects or pieces of furniture be installed at higher distances than those previously recommended, if you assume they could be damaged by the changes in temperature produced during the appliance operation.

1.8 Equipment

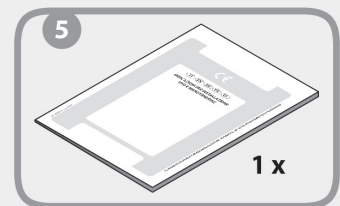
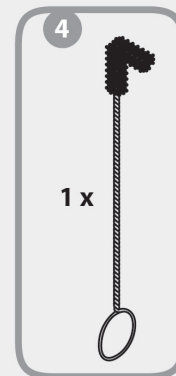
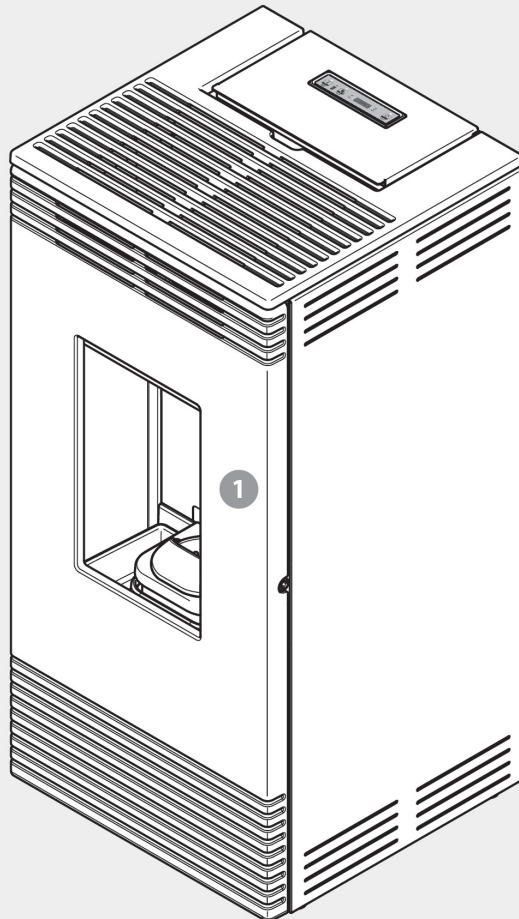
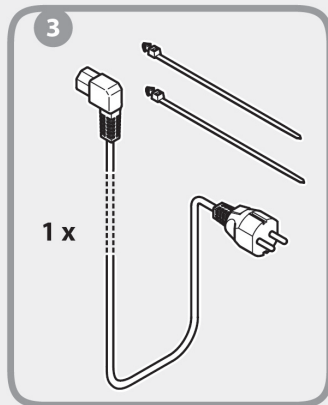

- 1 x 1
- 2 x 1 1115003400
- 3 x 1 0929910560
- 4 x 1 1093900500
- 5 x 1 INSTALLATION MANUAL

1.9 Functioning principle

This unit has been designed to burn dried, compressed, pelletized wood into a cast-iron container called burn pot where the optimum ratio of combustion air and pellet fuel is always ensured at each heat output that will be selected.

Varying the air supply proportionally to the pellet feed rate ensures the appliance excellent performance at all operating settings and represents an important feature enhancing the quality standards of this appliance. This procedure is handled automatically by the electronic control module: electronic card with microprocessor.

This highly developed module is responsible for controlling and adjusting the appliance functions in accordance with the requirements of the user.

The pellet feed rate, the flue gas flow discharged and the rate of warm air flow emitted into the room are automatically adjusted according to the operating setting selected through the control panel with chrono-thermostat.

In order to utilize to the utmost and avoid to waste the heat produced in the combustion chamber, a heat exchanger with vanes has been introduced in order to get the heat from those areas where the combustion products reach the highest temperature.

An air flow passing through a circuit inside the unit absorbs the heat by natural convection thus cooling the appliance for added protection.

The fan that distributes warm air in the room is the tangential type.

The high-head and -flow centrifugal exhauster ensures high efficiency and power in releasing the combustion products.

2 INSTALLATION

2.1 Packaging dismantling and disposal

Consisting of non-toxic and not noxious materials, the packaging does not need any special disposal procedure; the user is in charge of stocking, disposing of, or recycling the wastes of the packaging according to the regulations in force in the country where the product has been purchased.



WARNING: Keep plastic coverings out of the children's reach as they could represent a danger.

2.2 Installation requirements

The appliance must be installed in a space which allows to operate it and perform routine maintenance works easily. The room chosen for the installation of the appliance must therefore feature:

- Proper environment conditions and permanent outside air source as indicated under section 1.7 "Environment requirements".
- A floor with proportionate load capacity (see appliance weight in section 1.3.2 of the manual).
- 230 V~ 50 Hz line voltage.
- Electrical system complying with the directives in force.
- A system of exhaust gases complying with the standards in force aiming at guaranteeing:
 - Adequate draught for the correct and safe appliance operation.
 - Adequate resistance to high temperatures.
 - Adequate resistance to corrosion due to combustion products.
 - Easy access for periodic checks and maintenance.
 - Adequate insulation from inflammable materials.
- The room must also comply also with further standards in force in the country where the appliance is installed.

2.3 Appliance installation



ATTENTION: The installation of the appliance must be carried out by professional installers only. INVICTA does not authorize the installation of its appliances carried out by private customers.

2.3.1 Appliance Positioning



Before positioning the appliance on the ground it is necessary to unscrew the screws inside the cladding which anchor it to the pallet (to remove the sides of the cladding see section 2.3.7).

After choosing the most suitable location for your appliance, but before setting it in place, determine the center point of the flue gases outlet pipe (review sections 2.3.3 and 2.3.4 to see which most closely matches your situation), and using the measurements shown in the figure 1, make an access hole through the wall.

See section 2.3.2 for making the outside air intake hole.



IMPORTANT: When cutting a hole for the appliance exhaust pipe through a inflammable wall, provide the necessary insulation whose thickness may vary from a minimum of 3 cm up to a maximum of 10 cm. We otherwise recommend the use of lined pipes, which are also excellent for preventing condensation in exterior venting systems.



IMPORTANT: Pressure in the firebox is always negative. There will be a negative pressure in the exhaust pipe when it is connected to an efficient chimney flue as prescribed. The use of pipes and bends with gaskets ensuring airtight connections is recommended.

i The installation of your appliance must comply with all prescriptions and recommendations indicated under sections 1.5, 1.6, 1.7 and 2.2, and the electrical plug must be always accessible.

! **IMPORTANT:** All sections of the exhaust venting system must be removable to allow periodical maintenance (see figure 2).

Note: The schematic shown in the figure n° 2 indicates the necessary configurations for correct appliance operation: height - gradient - inspection access.

The most suitable type of insulation must be determined on a case-by-case basis for each flue gas exhaust venting system, and all external venting systems conduits must be insulated.

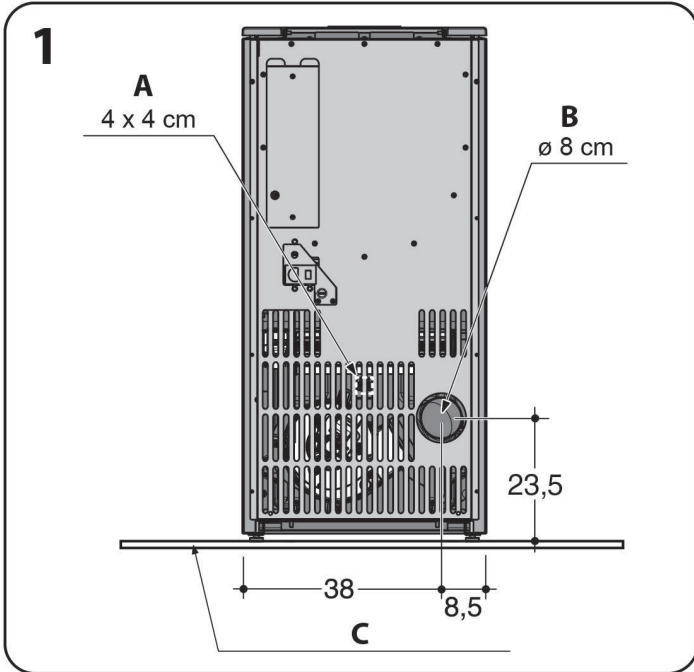

A. Combustion air inlet
 B. Smoke outlet
 C. Optional non-flammable floor protector

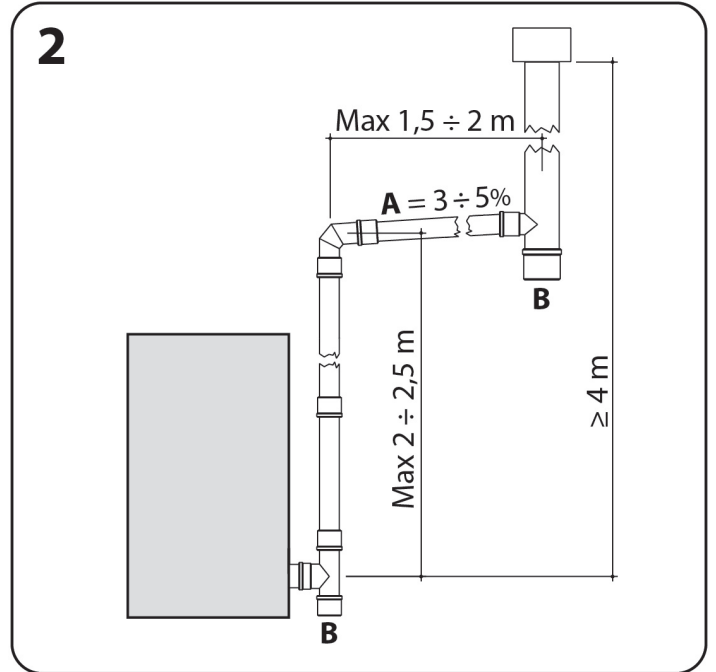

A. Gradient
 B. Clean-out door

i **IMPORTANT:** Once the appliance has been positioned in the pre-established place, it can be raised by means of the adjustable feet.

To adjust the height of the feet (after removing the sides of the cladding - see section 2.3.7) use a 5 mm hex key, screwing clockwise to raise the appliance and unscrewing counter-clockwise to lower it.

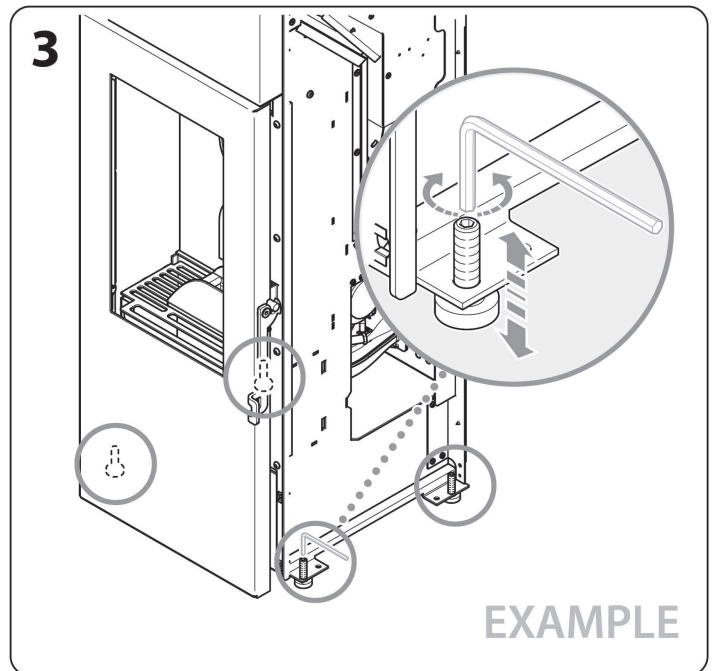

2.3.2 Outside air intake

For health and safety reasons, an outside air supply is recommended. This is also necessary to ensure proper combustion. Cut a hole through an exterior wall for a 100 sq.cm diameter outside air intake (\varnothing 12 cm hole), protected by both an interior and exterior grate.

i The air intake must not be on the back side of the appliance.

! **IMPORTANT:** In the room where the appliance is installed, make sure that there is an air flow rate of 40 cu.m/hour for combustion use.

2.3.3 Flue gases venting into a traditional chimney

- The minimum internal dimensions of the chimney flue must be 10x10 cm or 10 cm \varnothing and must not exceed 20x20 cm or 20 cm \varnothing ; if the existing chimney flue has a larger section or is in poor conditions (i.e. cracked, poor insulation etc.), you should install a 15 cm \varnothing stainless pipe up to the top of the chimney.
- Make sure the draught is in Pa, as indicated in the technical chart (see section 1.3.2).
- Provide a clean out door at the bottom of the chimney flue for routine inspection and yearly cleaning.
- The connection of the exhaust pipe to the flue must be sealed or secured with gaskets.
- The chimney flue must be terminated with a wind/rain cap; ensure the wind cap is installed above the top of the roof at a distance "d" varying in accordance with the local standards.

! **CAUTION:** If there has been a fire in the flue it is necessary to turn the appliance off and call the fire department and check whether the chimney stack and flue pipe have been visibly damaged. Make any repairs before any further use of the combustion system.

i If the smoke exhauster is out of order or in case of electrical outage, the connection of the exhaust pipe into an exterior vertical vent ensures the correct release of combustion gases.

i The draught value indicated among the technical features of the appliance refers to Technical Norms and testing, so as to guarantee the best thermal performances of the appliance (consumption, efficiency, emissions) in conformity with the technical data declared and certified by the Institute in charge of the certification. A higher draught value could provoke malfunctioning, high fuel consumption, overheating of the appliance body and cause annoying noises in the firebox.

i **IMPORTANT (FOR THE TECHNICIAN):** When sizing the flues of wood pellet burning appliances using dedicated software applications, you can use a pressure value of 0 Pascal as a reference to guarantee the necessary flue draught during operation (10-11-12 Pa).

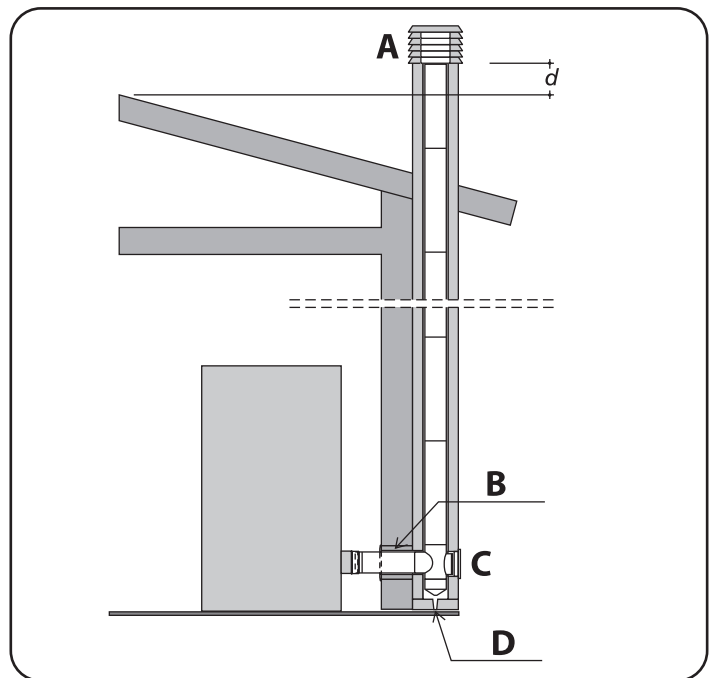

A. CHIMNEY WIND CAP
B. INSULATION
C. CLEAN-OUT DOOR
D. CONDENSATE DRAINAGE SYSTEM

2.3.4 Smoke outlet into exterior vertical vent (stainless steel lined type)

- The internal dimensions of the exterior vertical vent may vary from a min. 10 cm up to a max. 20 cm section.
- Make sure the draught is in Pa, as indicated in the technical chart (see section 1.3.2).
- Only double-wall lined pipes in stainless steel must be used adequately and anchored to the building.
- Provide a clean out door at the bottom of the exterior vertical vent for routine inspection and yearly cleaning.
- The chimney flue must be terminated with a wind/rain cap; ensure the wind cap is installed above the top of the roof at a distance "d" varying in accordance with the local standards.



CAUTION: If there has been a fire in the flue it is necessary to turn the appliance off and call the fire department and check whether the chimney stack and flue pipe have been visibly damaged. Make any repairs before any further use of the combustion system.



If the smoke exhauster is out of order or in case of electrical outage, the connection of the exhaust pipe into an exterior vertical vent ensures the correct release of combustion gases.



The draught value indicated among the technical features of the appliance refers to Technical Norms and testing, so as to guarantee the best thermal performances of the appliance (consumption, efficiency, emissions) in conformity with the technical data declared and certified by the Institute in charge of the certification. A higher draught value could provoke malfunctioning, high fuel consumption, overheating of the appliance body and cause annoying noises in the firebox.



IMPORTANT (FOR THE TECHNICIAN): When sizing the flues of wood pellet burning appliances using dedicated software applications, you can use a pressure value of 0 Pascal as a reference to guarantee the necessary flue draught during operation (10-11-12 Pa).

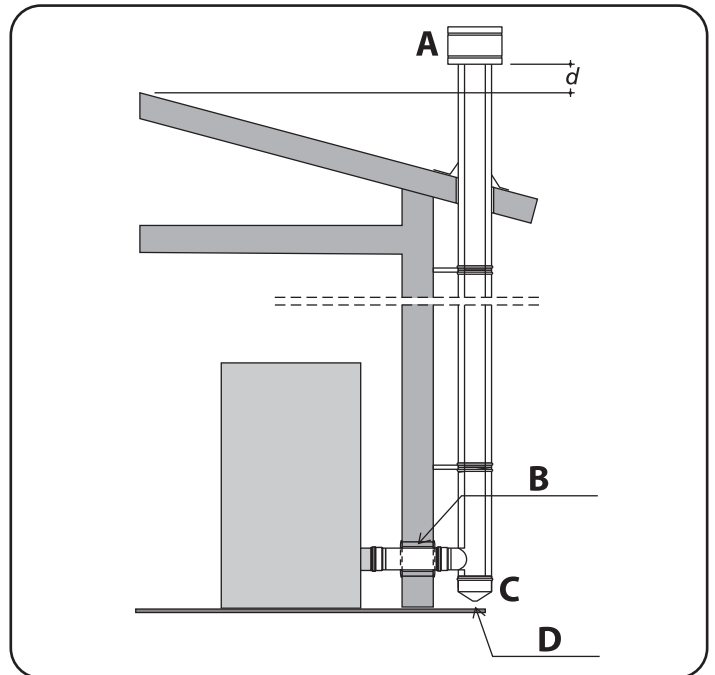

A. CHIMNEY WIND CAP
B. INSULATION
C. CLEAN-OUT DOOR
D. CONDENSATE DRAINAGE SYSTEM

2.3.5 Electrical connection

To be done after installing the cladding.

Insert its power plug into an appropriate wall socket.

- i** **Press the on/off switch only when you want to operate the appliance.**
Pressing the on/off switch will give power to the appliance.
The appliance will start in accordance with the operation mode selected (see section 3.3.1) or possibly in accordance with the pre-set programmes (see section 3.3.5).

- i** **Make sure the hopper is filled with enough pellets for the operating time that is set.**

2.3.6 Positioning the room temperature sensor

To be done after installing the cladding.

Place the room temperature sensor in a place where the average room temperature can be detected (we recommend not to install the sensor near windows or doors in order to avoid wrong temperature readings).

- i** **The correct positioning of the room temperature sensor ensures the correct operation of the appliance.**

2.3.7 Disassembling the cladding

If it should be necessary, for a maintenance intervention, to access the electrical and electronic parts, operate according to the following instructions to remove the cladding elements.

! **ATTENTION: To be on the safe side, wear work gloves.**

1. Carefully remove the cover.
2. Unscrew the 2 rear screws holding the sides of the cladding.
3. Carefully remove the sides.

i In the end correctly assemble the component parts removed in reversed sequence.

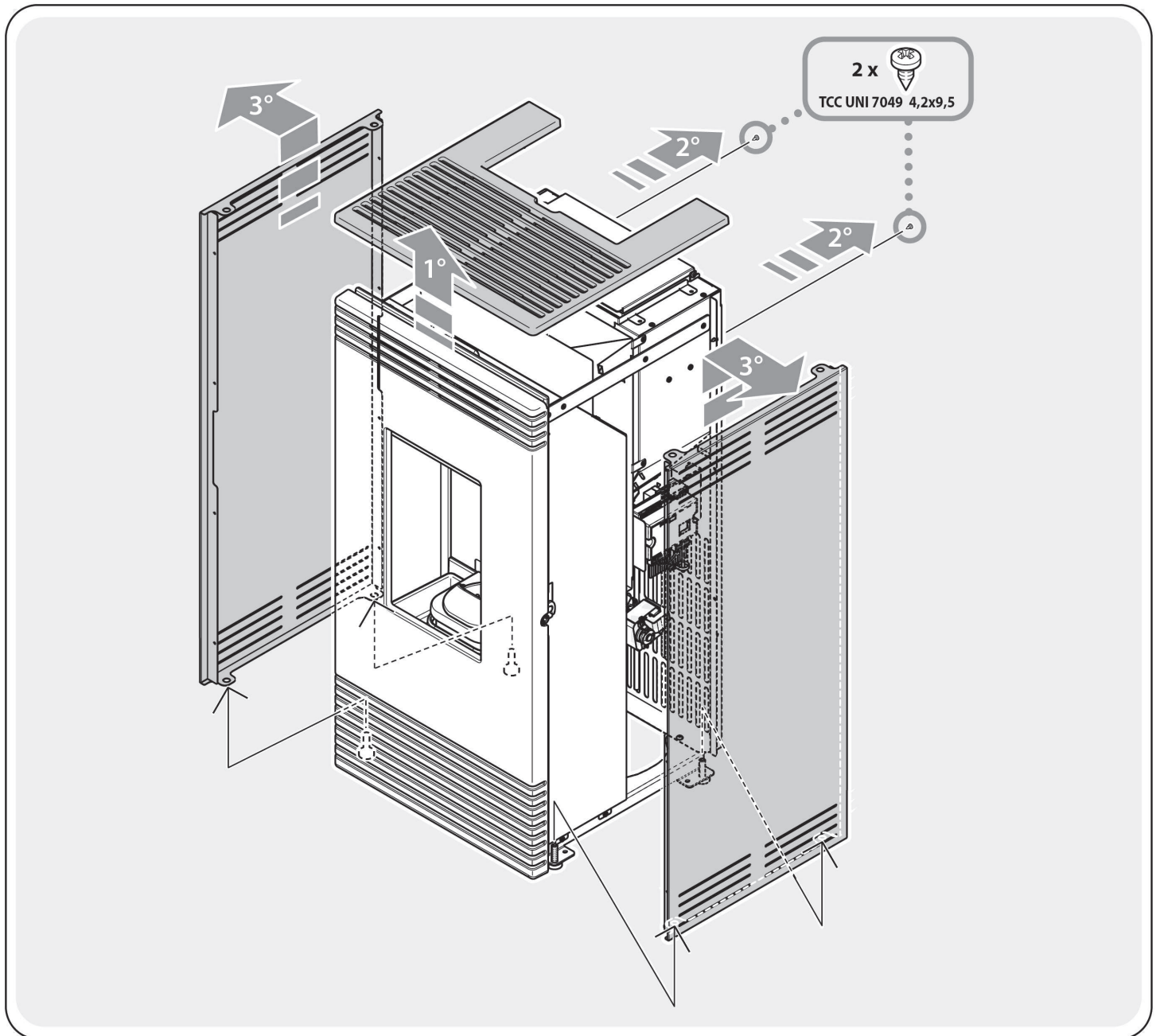

Example of PHILIA

3 OPERATION

3.1 Pre- and first-lighting instructions

Before lighting the appliance for the first time the following must be done:

- Remove the sticker from the glass and any adhesive marks if necessary.
- Ensure that all safety requirements are met (see sections 1.5 and 1.6).
- Electrical connection: After verifying that the line voltage is correct (230 V~ 50 Hz), flip the main switch located on the back panel of the appliance to the "ON" position.
- Check that the control panel display lights up, which indicates that appliance is powered.
- make sure the hopper is filled with enough fuel for the desired service time.

i The fuel quality standards must comply with what prescribed under section 1.4.

! CAUTION: Children must be supervised by an adult in order to prevent them from touching the appliance hot parts or modifying its functions.

i The metal component parts of the appliance are coated with a special high temperature paint that will reticulate, chemically stabilize and become fully heat resistant after the first few lightings. During this chemical reaction, the paint will smell bad and release vapours, thus it is recommended that the room be properly aerated. When this process is finished, no more bad smell and vapours will be released during the appliance normal operation.

3.2 Pellet loading

Open the lid of the loading port and fill the hopper with pellets of 6 ± 1.0 mm \varnothing with length $31.5 \leq L \leq 40.0$ mm (EN 14961-2 – Category A1).

! CAUTION: Do not remove the protection grate that is mounted inside the hopper.

! ATTENTION: The pellet that should accidentally fall outside the reservoir while loading it could come into contact with very hot parts of the appliance with the resulting risk of a fire. It is therefore necessary to use a specific shovel so that the pellet bag does not burden on the reservoir and/or does not touch the hot parts of the appliance.

The pellet that should fall out of the reservoir and finish in the areas between the reservoir and the cladding must be immediately removed.

! IMPORTANT: To ensure correct functioning of the appliance always close the lid of the hopper after refilling.

i Check the quantity of pellets in the hopper from time to time, and refill promptly whenever necessary in order to avoid setting off an appliance alarm due to low fuel level (the sustained sound of the acoustic alarm may cause a nuisance until the user has a chance to reset the system).



3.3 Control panel



CONTROL PANEL

 [P1] = [DECREASE/MENU/SET ENVIRONMENT].

 [P2] = [INCREASE/STOVE STATUS/SET POWER].

 [P3] = [ON/OFF/ESC/CONFIRM].

The appliance control panel is also equipped with eight led lights.

3.3.1 Starting your appliance

Before operating your appliance again, clean the ceramic glass door if needed (see section 4.1.2), remove any residual combustion products from the burn pot, clean the firebox, and vacuum up the ash residues in the burn pot and ash pan (see section 4.1.3). If the appliance has not been used for a long time, remove any pellets that may still be in the fuel hopper because they could have lost their original properties which ensure a good combustion. Also vacuum any pellet sawdust from the hopper.

 **IMPORTANT: This last procedure must be carried out using an appropriate vacuum cleaner. Never remove the protective grate from the top of the pellet hopper for any reason, not even temporarily.**

Activate the appliance by putting in the ON position the switch for the ignition of the control panel placed in the back.

The display shows the switched-off status of the appliance, the ambient temperature and the time; the OFF message scrolls, followed by the temperature and the time.

The control panel of the appliance is equipped with a lit display and with three buttons as described below:



View of message scrolling on display:
OFF - 21.1 - 14:05

 In the case of first ignition: remember that the screw auger feeding the pellets is empty; it is therefore necessary to wait for a certain time until it is filled and the burn pot is fed; for that purpose choose the function [FIRST LOAD] from the user menu.

To switch on the appliance press the button [P3] for a few seconds. When the appliance is switched on this is shown in the display with the wording [Start] and by the flashing ON\OFF led light. In these conditions the appliance goes into preheating phase, the resistance switches on (resistance led on) and also the smoke exhauster.

Any irregularities during the ignition phase are shown on the display and the appliance goes into the alarm status (see section 3.3.6).



View of message scrolling on display:
START

Once the ignition procedure has started, 3 function modes follow:

- **Loading pellet:** the pellet loading stage starts after around 1 minute, the wording [Load Pellet] scrolls on the display and the ON\OFF led flashes. In the initial phase the screw auger loads the pellet into the burn pot (screw auger led on). In the second phase, the screw auger switches off (screw auger led off). If ignition does not take place after this phase, the screw auger comes on again to feed the burn pot.



View of message scrolling on display:
LOAD PELLET

- **Flame present:** after combustion is activated and a sufficient level of heating is reached, the appliance goes into the ignition status showing the wording [Flames Present] on the display and the ON\OFF led flashes.



View of message scrolling on display:
FLAMES PRESENT

- **Work:** after the appliance has reached an adequate development of combustion and a sufficient level of heating maintained for an suitable time, it will go into work status, which is the normal operating status. The display shows the wording relating to the work status followed by the operating power and the ambient temperature [Working - on5 - 22.5c], the ON\OFF led is on constantly, and the air exchanger fan comes on (fan led on).



View of message scrolling on display:
WORKING - ON5 - 22.5c

At time-intervals regulated by the electronic card the appliance positions itself on the "cleaning" operational mode to maintain the burn pot clean and efficient, and showing the wording [Cleaning Fire-Pot] on the display.



View of message scrolling on display:
CLEANING FIRE-POT

IMPORTANT: If the ignition fails, the appliance goes into "ignition failed" alarm status and the message [AL 5 ALAR AL 5 NO LIGHTING] scrolls on the display.

Before a second ignition is attempted, completely remove any residual combustion products from the burn pot.

CAUTION: In the following cases always remove any pellets that may still be in the burn pot before restarting the appliance:

- After every failed ignition.
- After selecting the switch-off mode before the ignition cycle is completed.
- On re-igniting following switching off because of lack of pellet.

ATTENTION: For safety reasons never put these pellets in the fuel hopper.

3.3.2 Switching off

To switch off the appliance just press the button [P3] for a prolonged period of time. The display shows the "final cleaning" message [Final Cleaning]. The screw auger stops (screw auger led off), and the ON\OFF led flashes.

The air exchanger fan and the smoke exhauster remain on until the appliance cools down completely. After a pre-established time, if the appliance remains cold, it switches off, showing the message [Off] on the display.



View of message scrolling on display:
FINAL CLEANING



View of message scrolling on display:
OFF

CAUTION: Never switch off the appliance by disconnecting the power plug.
This may adversely affect the structural integrity of the appliance and cause failures by the following lighting.

3.3.3 Setting maximum operating power

There are 5 operating powers on the appliance and they are managed automatically by the appliance. During normal operation (Work) the maximum operating power can be modified by acting on the button [P2]. (Set power led on). To increase the power press [P2] again, and to reduce the power press [P1]. The power level set can be viewed on the display. To exit the setting wait for 5 seconds without carrying out operations on the control panel, or press [P3].



View of message scrolling on display:
POT3

CAUTION: Never switch off the appliance by disconnecting the power plug.
This may adversely affect the structural integrity of the appliance and cause failures by the following lighting.

3.3.4 Setting ambient temperature

To modify the set ambient temperature just act on button P1. The display will show the set ambient temperature (temperature SET). By then acting on the buttons [P1] (reduce) and [P2] (increase), you can modify its value. After around 5 seconds the value is memorized and the display returns to normal viewing, or to exit press button [P3].



View of message scrolling on display:
22.5c

When the ambient temperature has reached the set value, the power of the appliance goes automatically to the minimum value. In these conditions the display shows the message [Modulat-]. If the ambient temperature drops below the set value, the appliance returns to "Work" mode and to the power previously set (Set power).

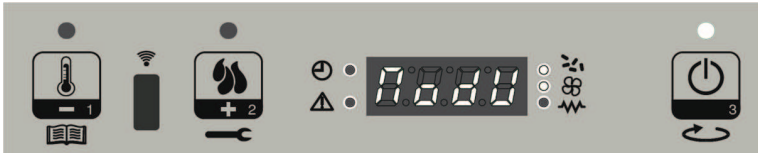

View of message scrolling on display:
MODULAT-

MANUAL MODE:

If the ambient temperature is set above 40°C the wording [man] appears on the display and the appliance goes into manual mode, keeping the set operating power fixed without going to the minimum, whatever ambient temperature is reached.

THERMOSTAT MODE:

If the ambient temperature is set below 6°C the wording [t- e] appears on the display and the appliance goes into thermostat mode; this mode allows the appliance to switch on and off by using a thermostat or an external switch connected to the appropriate terminal on the electronic card of the appliance (see section 5.2).

STAND BY:

Enabled from the menu, the stand-by function switches off the appliance if, for more than 60 minutes, the ambient temperature is above the set temperature of 3°C. The wording [Go-Stby] appears on the display followed by the minutes remaining to switching off; after this, the wording [Wait Cooling] appears on the display. In this case the appliance stops the screw auger, the heat exchanger fan and the smoke exhauster remain on until the appliance has cooled and the ON\OFF led flashes.

When the appliance has cooled down it goes into stand-by mode and the wording [Stop Eco Temp Good] scrolls. If the ambient temperature drops below the set temperature of -1°C, the appliance switches on again.



View of message scrolling on display:
GO-STBY

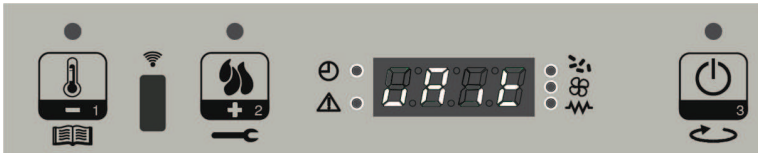

View of message scrolling on display:
WAIT COOLING



View of message scrolling on display:
STOP ECO TEMP GOOD

CAUTION: Never switch off the appliance by disconnecting the power plug. This may adversely affect the structural integrity of the appliance and cause failures by the following lighting.

3.3.5 Menu

To access the menu press the button [P1] for a prolonged period of time; the wording [M1 set clock] scrolls on the display. The menu is divided into various sub-menu items and levels that allow access to the appliance settings and programming.

To scroll the menu press the buttons [P1] or [P2].

To confirm a required choice from the menu press button [P3].

Menu M1 - SET CLOCK:

Set the current date and time. To enter the menu press the button [P3]- Select the required day of the week by pressing [P1] or [P2] and confirm by pressing button [P3]. This is followed by setting of the hour, minutes, day of the month, the month and the year by acting on the buttons [P1] or [P2] and confirming by pressing button [P3].

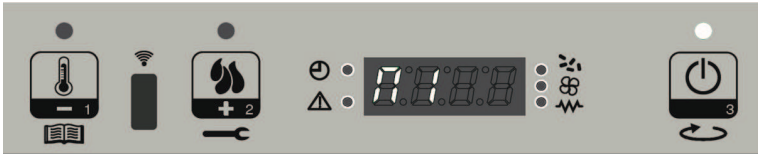

View of message scrolling on display:
M1



View of message scrolling on display:
MOND (TUES WEDN THUR FRID SATU SUND)



View of message scrolling on display:
HOURS CLOCK

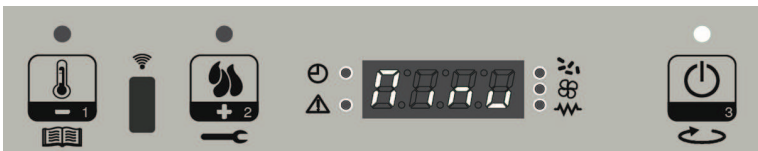

View of message scrolling on display:
MINUTES CLOCK



View of message scrolling on display:
DAY CLOCK

Menu M2 - SET CHRONO:

This allows all the programmable thermostat functions to be set. To enter the menu press the button [P3] and subsequently press [P1] or [P2] to select the sub-menu required. Confirm with the button [P3].

Sub-menu M2 - 1 ENABLE CHRONO:

This allows the programmable thermostat to be enabled and disabled; press [P1] "ON" to enable and [P2] "OFF" to disable and confirm with button [P3]. Enabling of the programmable thermostat is confirmed when the chrono led is on.



View of message scrolling on display:
CHRONO ENABLE

Sub-menu M2 - 2 PROGRAM DAY:

Confirm the menu choice with button [P3].

DAILY CHRONO:

This allows the daily program of the programmable thermostat to be enabled and modified; press [P1] "ON" to enable or [P2] "OFF" to disable, confirm and go on to the following page with the button [P3].

The appliance has 2 daily programs that allow it to be switched on twice and switched off twice per day.



View of message scrolling on display:
CHRONO DAILY

- **Start 1 day OFF**

To set the time of the first switch-on (start 1) of the appliance press [P1] or [P2]; to ignore the first switch-on set the time to "OFF", confirm and go on to the next page with the button [P3].

- **Stop 1 day OFF**

To set the time of the first switch-off (stop 1) of the appliance press [P1] or [P2]; to ignore the first switch-off set the time to "OFF", confirm and go on to the next page with the button [P3].

- **Start 2 day OFF**

To set the time of the second switch-on (start 2) of the appliance press [P1] or [P2]; to ignore the second switch-on set the time to "OFF", confirm and go on to the next page with the button [P3].

- **Stop 2 day OFF**

To set the time of the second switch-off (stop 2) of the appliance press [P1] or [P2]; to ignore the first switch-off set the time to "OFF", confirm and go on to the next page with the button [P3].

Sub-menu M2 - WEEKLY PROGRAM:

WEEKLY CHRONO:

This allows the weekly program of the programmable thermostat to be enabled and modified; press [P1] to enable "ON" or [P2] to disable "OFF", confirm and go on to the next page with the button [P3]. The appliance has 4 weekly programs that allow it to be switched on 4 times and switched off 4 times per day.

Each program offers 9 options in rotation for setting/enabling, according to the following table.

program 1	program 2	program 3	program 4
Start prog 1 OFF	Start prog 2 OFF	Start prog 3 OFF	Start prog 4 OFF
Stop prog 1 OFF	Stop prog 2 OFF	Stop prog 3 OFF	Stop prog 4 OFF
Monday prog 1 OFF	Monday prog 2 OFF	Monday prog 3 OFF	Monday prog 4 OFF
Tuesday prog 1 OFF	Tuesday prog 2 OFF	Tuesday prog 3 OFF	Tuesday prog 4 OFF
Wednesday prog 1 OFF	Wednesday prog 2 OFF	Wednesday prog 3 OFF	Wednesday prog 4 OFF
Thursday prog 1 OFF	Thursday prog 2 OFF	Thursday prog 3 OFF	Thursday prog 4 OFF
Friday prog 1 OFF	Friday prog 2 OFF	Friday prog 3 OFF	Friday prog 4 OFF
Saturday prog 1 OFF	Saturday prog 2 OFF	Saturday prog 3 OFF	Saturday prog 4 OFF
Sunday prog 1 OFF	Sunday prog 2 OFF	Sunday prog 3 OFF	Sunday prog 4 OFF
<i>continues program 2</i>	<i>continues program 3</i>	<i>continues program 4</i>	<i>continues program 1</i>

- **Start program 1 / 2 / 3 / 4 OFF**

To set the time of the first/second/third/fourth switch-on (start prog 1/2/3/4) of the appliance press [P1] or [P2]; to ignore the first/second/third/fourth switch-on set the time to "OFF", confirm and go on to the next page with the button [P3].

- **Stop program 1 / 2 / 3 / 4 OFF**

To set the time of the first/second/third/fourth switch-off (start prog 1/2/3/4) of the appliance press [P1] or [P2]; to ignore the first switch-off set the time to "OFF", confirm and go on to the next page with the button [P3].

- **Monday prog 1/2/3/4 OFF**

To enable this program on Monday press [P1] "ON"; to disable it press [P2] "OFF", confirm and go on to the next page with the button [P3].

- **Tuesday prog 1/2/3/4 OFF**

To enable this program on Tuesday press [P1] "ON"; to disable it press [P2] "OFF", confirm and go on to the next page with the button [P3].

- **Wednesday prog 1/2/3/4 OFF**

To enable this program on Wednesday press [P1] "ON"; to disable it press [P2] "OFF", confirm and go on to the next page with the button [P3].

- **Thursday prog 1/2/3/4 OFF**

To enable this program on Thursday press [P1] "ON"; to disable it press [P2] "OFF", confirm and go on to the next page with the button [P3].

- **Friday prog 1/2/3/4 OFF**

To enable this program on Friday press [P1] "ON"; to disable it press [P2] "OFF", confirm and go on to the next page with the button [P3].

- **Saturday prog 1/2/3/4 OFF**

To enable this program on Saturday press [P1] "ON"; to disable it press [P2] "OFF", confirm and go on to the next page with the button [P3].

- **Sunday prog 1/2/3/4 OFF**

To enable this program on Sunday press [P1] "ON"; to disable it press [P2] "OFF", confirm and go on to the next page with the button [P3].

Sub-menu M2 - 4 WEEKEND PROGRAM:

Weekend chrono OFF

This allows the weekend program (Saturday and Sunday) of the programmable thermostat to be enabled and modified; press [P1] to enable "ON" or [P2] to disable "OFF", confirm and go on to the following page with the button [P3]. The appliance has 2 programs for the weekend, allowing 2 switch-ons and 2 switch-offs per day.

- **Start 1 weekend OFF**

To set the time of the first switch-on (start 1) of the appliance press [P1] or [P2]; to ignore the first switch-on set the time to "OFF", confirm and go on to the next page with the button [P3].

- **Stop 1 weekend OFF**

To set the time of the first switch-off (stop 1) of the appliance press [P1] or [P2]; to ignore the first switch-off set the time to "OFF", confirm and go on to the next page with the button [P3].

- **Start 2 weekend OFF**

To set the time of the second switch-on (start 2) of the appliance press [P1] or [P2]; to ignore the second switch-on set the time to "OFF", confirm and go on to the next page with the button [P3].

- **Stop 2 weekend OFF**

To set the time of the second switch-off (stop 2) of the appliance press [P1] or [P2]; to ignore the first switch-off set the time to "OFF", confirm and go on to the next page with the button [P3].

Sub-menu M2 - 5 EXIT:

Allows you to exit the menu.

MENU M3 - LANGUAGE:

Allows you to choose the language from those available; scroll through the languages with the buttons [P1] or [P2], confirm and go on to the next page with the button [P3].



View of message scrolling on display:
LANGUAGE

Menu M4 - STAND BY:

Allows the Stand-by function to be enabled; this switches off the appliance if, for more than 60 minutes, the ambient temperature is above the set temperature of 3°C. To enable or disable act on buttons [P1] or [P2] to confirm and go on to the next page with the button [P3].



View of message scrolling on display:
STAND-BY

Menu M5 - BUZZER:

Allows the sound-signal buzzer to be enabled or disabled during alarm statuses. To enable or disable act on buttons [P1] or [P2]; to confirm, press [P3].

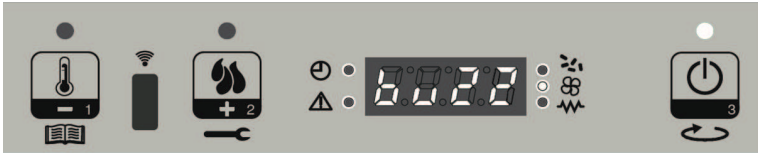

View of message scrolling on display:
BUZZER

Menu M6 - FIRST LOAD:

This function is available only when the appliance is switched OFF; it allows loading of the screw auger at first start up when the fuel hopper is empty. After selecting the menu M6, the wording [Press More] scrolls on the display. Then press [P2]. The smoke exhauster switches on at maximum speed, the screw auger switches on (screw auger led on) and they remain like this until the time shown on the display has elapsed, or until the button [P3] is pressed.

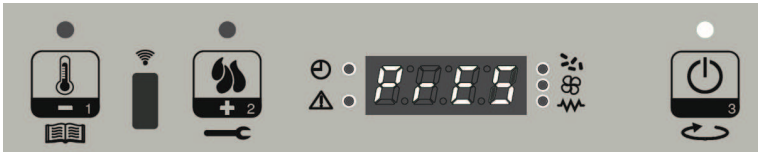

View of message scrolling on display:
PRESS MORE



View of message scrolling on display:
90''

Menu M7 - STOVE STATUS:

This function allows you to view the status of some variables during the operation of the stove in work mode. The table below shows an example of the statuses viewed on the display and their meanings.



View of message scrolling on display:
STATUS STOVE

Status viewed	Meaning
3,1"	Pellet loading screw auger status
52'	Time out
Toff	Thermostat status
106°	Smoke temperature
1490	Smoke exhaust speed

Menu M8 - PELLET TYPE:

This function provides the facility to view and edit the combustion parameters associated with the pellet load.



View of message scrolling on display:
PR 54 LOADING PELLET 00

At the first ignition check for at least 6 continuous hours that the combustion meets the following requirements:

- there must not be any tendency to fuel build up in the burn pot given to an excess of fuel or lack of draught.
- There must not be any tendency to flame extinguishing for lack of fuel or for excessive draught.

Since the proper functioning of the appliance depends on the environmental conditions and especially on the draught, on the connection to the chimney flue and on the type of pellet used, should the user notice one of the above tendencies, after having checked that the stove is perfectly cleaned (see paragraphs 4.1.3, 4.2.1 and eventually 4.2.2), a different set of parameters among those available and set by the factory could be necessary.

There are 19 parameters organised according to the pellet density and specific gravity.

Choose the most appropriate parameter to guarantee good combustion, according to the following indications:

- If the pellets tend to build up in the burn pot, choose a parameter lower than the current one, monitor combustion for at least one hour, and, if necessary, reduce the parameter setting until the combustion requirements illustrated above are met.
- If there is a tendency for the flame to extinguish, choose a higher parameter than the current one, monitor combustion for at least one hour, and, if necessary, increase the parameter setting until the combustion requirements illustrated above are met.

Use buttons 1 and 2 to adjust the pellet load percentage from a maximum value of + 9 to a minimum of - 9. Each change alters the pellet load of all 5 power settings of the unit. (Parameter factory setting = 0).



ATTENTION: it is recommended to carry out the combustion calibration correctly because in case of flame extinguishment, unburnt pellet could distillate in the burn pot and lead to its explosion in the combustion chamber.

Summary parameter table

Parameters to be selected when there is a tendency to

FLAME EXTINGUISHING



Parameters to be selected when there is a tendency to

PELLET BUILD UP

Menu M9 - TECHNICIAN CALIBRATIONS:

CAUTION: Access to this menu, allowed by inserting an access key, is for installers or expert personnel, since the parameters shown, if modified, may render the product unsuitable for application in use.



View of message scrolling on display:
KEY ACCESS

Menu MA - EXIT:

Allows you to exit the menu.



View of message scrolling on display:
ESCAPE

3.3.6 Alarm warnings

CAUTION: Always remove any pellets that may still be in the burn pot before restarting the appliance, when an alarm causes the turning off of the appliance.

If an operating fault should occur, the appliance intervenes and signals that the irregularity has happened by switching on the alarms led (alarm led on) and emitting sound signals.

i Any alarm situation causes the appliance to switch off immediately.

The alarm status is reached after 30 seconds, except for the POWER FAILURE alarm, and can be zeroed by prolonged pressing of button [P3]. Whenever an alarm is zeroed an appliance switch-off phase is started, as a safety measure. In the alarm phase the alarms led is always on and, if enabled, the buzzer sounds intermittently. If the alarm is not reset, the appliance starts the switch-off phase anyway, while still displaying the alarm message on the display.

WARNING: After each alarm episode it is always necessary to wait for the appliance to cool down completely, after which you can proceed to disconnecting it by positioning the switch on the back to OFF and, if maintenance is necessary, unplugging it from the mains. After carrying out the instructions for the respective solutions, you can proceed to start-up, positioning the switch on the back to ON and after waiting for the appliance to return to the OFF status.

An alarm situation can be caused by a breakdown on the appliance; in this case, if the appliance does not start up correctly after the respective instructions for the solutions have been carried out, the services of a qualified technician are necessary to reactivate the appliance and to check the causes that triggered the alarm.

POWER FAILURE ALARM:

While the appliance is working, there may be an electric power failure. On restarting, if the power failure period is less than 30 seconds, the appliance starts up again in WORK mode; otherwise the alarm intervenes.

The relative message scrolls on the display and the appliance goes into alarm status, starting the switch-off phase.



View of message scrolling on display:
AL 1 ALAR AL 1 BLACK-OUT

SMOKE TEMPERATURE SENSOR ALARM:

This appears when the smoke sensor is faulty. The appliance goes into alarm status, and the alarms led comes on.

The relative message scrolls on the display and the appliance goes into alarm status, starting the switch-off phase.

*Solution: The services of a qualified technician will be required to first verify what set off the alarm, and then to correct the problem.



View of message scrolling on display:
AL 2 ALAR AL 2 PROBE EXHAUST

SMOKE OVERTEMPERATURE ALARM:

Indicates that the smoke temperature is too high because of:

- Lack of ordinary cleaning maintenance of the appliance.
- Incorrect combustion calibration.

The relative message scrolls on the display and the appliance goes into alarm status, starting the switch-off phase.

Solution: In the first case, routine maintenance must be carried out, and in the second case, the services of a qualified technician are necessary to modify the combustion parameters.

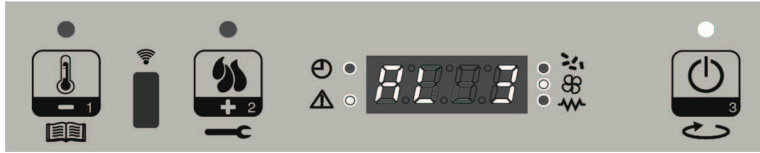

View of message scrolling on display:
AL 3 ALAR AL 3 HOT EXHAUST

SMOKE ENCODER FAULT ALARM:

This appears if there is a fault on the smoke exhauster.

The relative message scrolls on the display and the appliance goes into alarm status, starting the switch-off phase.



View of message scrolling on display:
AL 4 ALAR AL 4 FAN FAILURE

SWITCH-ON FAILURE ALARM:

This appears when the switch-on phase fails. This happens if, when 25 minutes has elapsed, the temperature of the smoke is not above 55°C.

The relative message scrolls on the display and the appliance goes into alarm status, starting the switch-off phase.

Solution: Check the cleaning of the burn pot and the part underneath (see section 4.1.3).

All the fuel present in the burn pot must always be removed.



View of message scrolling on display:
AL 5 ALAR AL 5 NO LIGHTING

PELLET ABSENT ALARM:

This appears when, in the work phase, the temperature of the smoke drops below 55°C.

The relative message scrolls on the display and the appliance goes into alarm status, starting the switch-off phase.

Solution: If the fuel shows a tendency to be extinguished, a qualified technician must be contacted to modify the combustion parameters.

All the fuel present in the burn pot must always be removed.



View of message scrolling on display:
AL 6 ALAR AL 6 NO PELLETS

THERMAL SAFETY OVERTEMPERATURE ALARM:

This appears when the general safety thermostat detects a temperature above the trigger threshold. The thermostat intervenes and switches off the screw auger, since it is placed in series to its feed and the appliance signals the alarm status (alarm led on). The relative message scrolls on the display and the appliance goes into alarm status, starting the switch-off phase.

Solution: Once the switch-off phase is terminated, the following operations are necessary:

- Put the switch in the back of the appliance in the OFF position.
- Reactivate the thermostat also placed in the back of the appliance (unscrewing the black cap, pushing the central button and put the cap back in its place).



View of message scrolling on display:
AL 7 ALAR AL 7 SAFETY THERMAL

DEPRESSION ABSENT ALARM:

This appears when the pressure controller outside component detects an overpressure in the smoke exhauster flue. The pressure controller intervenes and switches off the screw auger, as they are electrically connected in series, and the appliance signals the alarm status.

The relative message scrolls on the display and the appliance goes into alarm status, starting the switch-off phase.

Solution: If the overpressure is temporary, the appliance starts working properly once this overpressure disappears; if it persists, make sure the exhaust flue is free from any obstructions.



View of message scrolling on display:
AL 8 ALAR AL 8 FAILURE DEPRESS

3.3.7 SERVICE signal

- i** To ensure constant and efficient operation of the appliance, you must carry out the routine maintenance work stated, which varies according to the hours of operation and the quantity of fuel burnt. When the appliance reaches 2000 hours of operation, the message SERVICE appears on the control panel, meaning that it has to be serviced by a qualified technician.



View of message scrolling (each minute for 10 seconds) on display:
SERVICE

4 CARE AND MAINTENANCE

4.1 Recurrent maintenance

Do not forget that performing the following recurrent maintenance will ensure your appliance efficiency and proper operation for a long time.

! **WARNING:** All cleaning of the various parts must be done when the appliance is completely cold and disconnected from the electrical power source (electrical plug disconnected).

4.1.1 Cleaning of display screen and exterior cladding elements

Clean with a dry, soft cloth; do not use any detergent or cleaning products.

4.1.2 Cleaning of ceramic glass

To perform if needed.

i The quality and type of fuel as well as the way of use can determine the frequency of cleaning the ceramic glass.

1. We recommend the use of a specific glass cleaner for perfect cleaning;
2. spray some cleaner on a soft cloth to remove any tar and soot stains from the glass.

i Never spray the ceramic glass directly with a specific glass cleaner or with any other cleaning product

⊘ The use of any abrasive sponges or similar for cleaning the ceramic glass panel is **FORBIDDEN**; failure to do so may result in permanent damage.

! **IMPORTANT:** Ensure that you lock the door correctly with the equipped tool after opening it sideways to perform the ceramic glass cleaning.



4.1.3 Recurrent maintenance of type A

To perform at least twice a week or daily, depending on the operational conditions.

i By operating your appliance over a period of time you will find out how frequently it needs to be inspected and cleaned.

! **WARNING: All cleaning of the various parts must be done when the appliance is completely cold and disconnected from the electrical power source (electrical plug disconnected).**

The frequency of maintenance performed on your appliance is directly proportional to the operation hours and the performance requested.

! **CAUTION: For safety reasons, before cleaning the appliance make sure the ashes have cooled completely and then remove them with a vacuum cleaner.**

The recurrent maintenance works of type A are as follows:

1. Open the appliance door slowly, so as to avoid the displacement of ashes accumulated.
2. Remove the burn pot [B].
- 3a. From burn pot [B], remove any ashes and ash material that may accumulate and clog the air admission openings by means of a vacuum cleaner and a wire brush or any other tool sufficiently abrasive.
- 3b.



4. Lift the firebox ash collecting drawer [H] and take it completely out to empty it.
5. Remove any ashes that may accumulate inside the firebox, the burn pot ash-tray and the door by means of a powerful vacuum cleaner (1000÷1300 W).
6. With a vacuum cleaner remove the ashes from the area underneath the ash collecting drawer.
7. Vacuum clean all the ashes collected on the door.

When the cleaning is completed, install all the parts removed following the inversed order.



WARNING: Replace the burner correctly so as to avoid failures in lighting with potential overpressures in the combustion chamber and the accumulation of pellet.

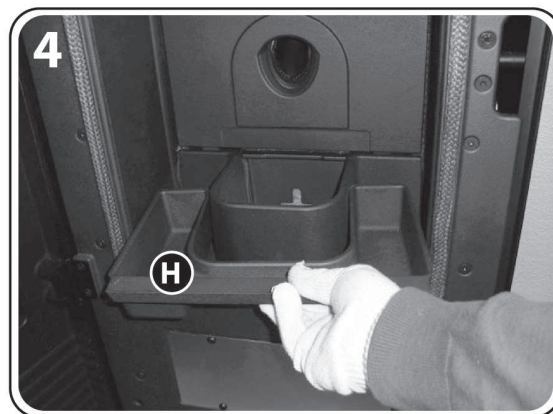

4.2 Routine maintenance

Do not forget that performing the following routine maintenance (type B and C) will ensure your appliance efficiency and proper operation for a long time. The same care and maintenance should be provided to the smoke exhaust system so as not to invalidate the work done on the appliance.

! **IMPORTANT:** after approximately 150 h of use or after 200 kg of fuel consumed, it is important to check and clean the smoke exhaust through the corresponding inspection doors or, if they are not present, dismantle the removable components.

4.2.1 Routine maintenance of type B

To perform in addition to recurrent maintenance of type A every 350÷400 hours or 500÷600 kg of pellets.

! **CAUTION:** The use of a pellet which produces lots of combustion residues can make the appliance get dirty more rapidly, thus causing frequent cases of pellet buildup. In such case it is absolutely necessary to reduce the time interval between routine maintenances of type B to no more than 250÷300 hours of use.

! **WARNING:** All cleaning of the various parts must be done when the appliance is completely cold and disconnected from the electrical power source (electrical plug disconnected).

! **CAUTION:** For safety reasons, before cleaning the appliance make sure the ashes have cooled completely and then remove them with a vacuum cleaner.

The routine maintenance works of type B are as follows:

1. Hold the cast iron plate [P] firmly with one hand to avoid tipping, and with the other hand rotate the retaining hook anti-clockwise, to remove it.
2. Take hold of the cast iron plate [P] with both hands, lift it, tilt it slightly and remove it, being careful not to bump against the device frame.
3. Clean all the back of the heat exchanger with vanes [S] with the equipped 90° metal brush, also clean inside the two holes in the lower part (see arrows in the pictures).

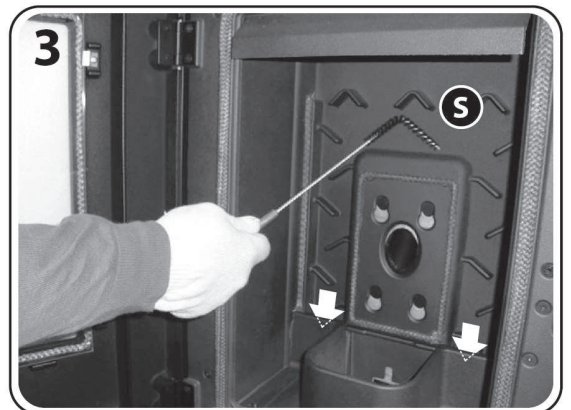
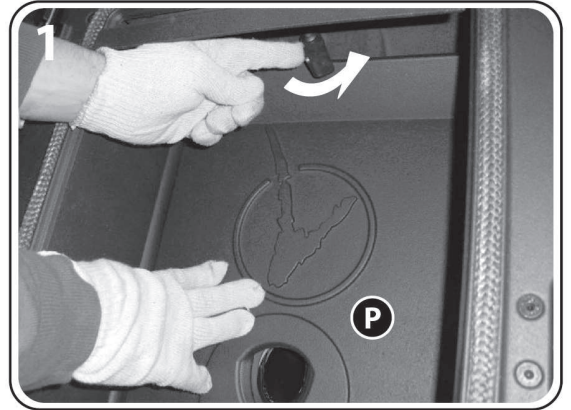

4. Remove any material scraped off from the heat exchanger with vanes [S] by means of a vacuum cleaner.
5. Unscrew and remove the 4 screws holding the cover of the heat exchanger dust collecting compartment [V].
6. Remove the heat exchanger dust collecting compartment lid [V] taking care to maintain the seal.
7. Remove the soot with a shovel, then suck the soot and ash left inside the heat exchanger dust collecting compartment by means of a vacuum cleaner.

When the cleaning is completed, install all the parts removed following the inverted order.

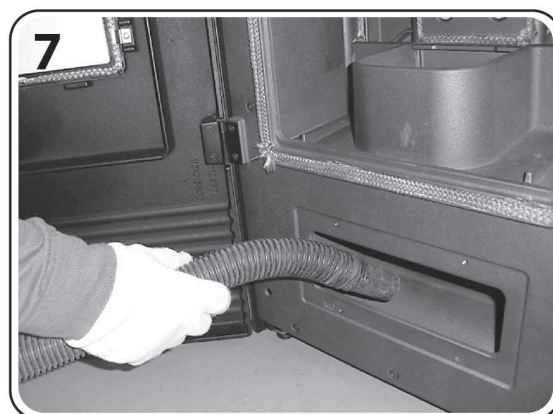
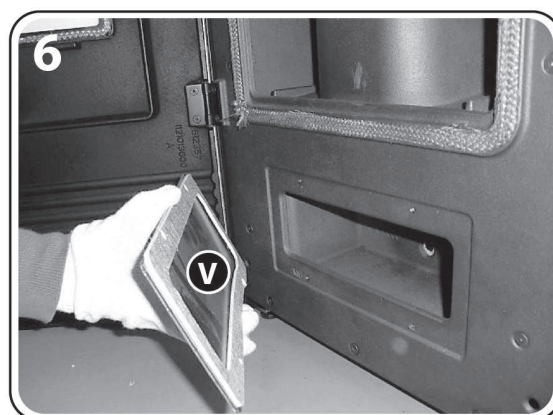
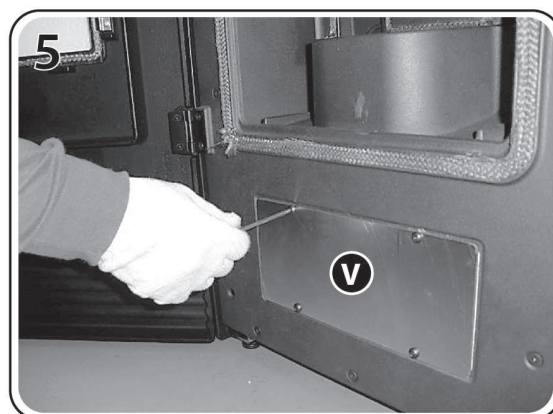

4.2.2 Routine maintenance of type C

To be done at the end of the heating season or when the appliance reaches 2000 hours of operation in addition to the recurrent maintenance work type A and to the routine maintenance work type B.

i The routine maintenance of type C shall be performed in order to clean the smoke exhauster [Q] and its housing and to facilitate the cleaning of the lower part of the heat exchanger. This maintenance work is to be completed on both sides of the appliance after removing the external lining.

! CAUTION: The following operation should be performed by a qualified service technician.

! WARNING: All cleaning of the various parts must be done when the appliance is completely cold and disconnected from the electrical power source (electrical plug disconnected).

! CAUTION: For safety reasons, before cleaning the appliance make sure the ashes have cooled completely and then remove them with a vacuum cleaner.

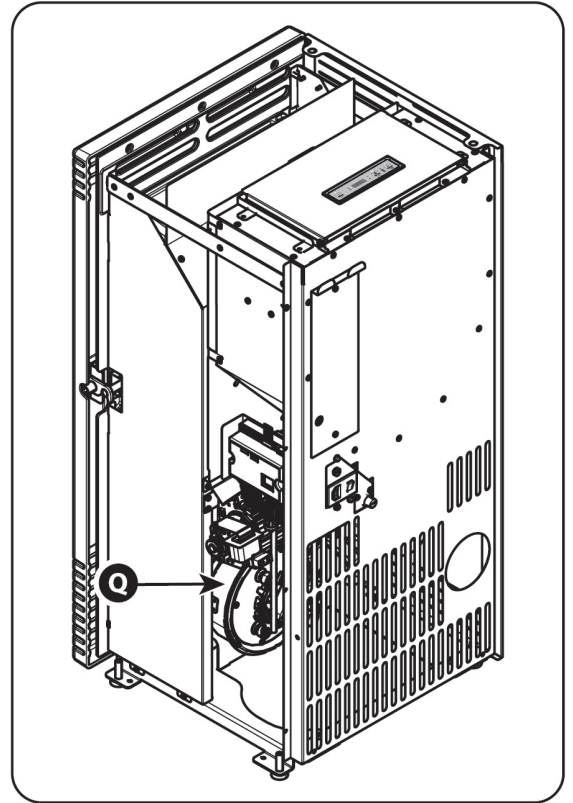

4.2.3 Gasket control

At the end of the heating season, during the routine maintenance of type C, have the qualified technician check the integrity of the gasket sealing the door and of all the removable parts.

They should be replaced once every one or two or three years, depending on the type of appliance and mostly on the operation duration. In order to ensure an air-tight assembly the gaskets should maintain their characteristics of elasticity; as soon as they harden they need to be replaced.

4.2.4 Cleaning of vertical venting pipes

Even with the best appliances and chimneys the formation of creosote deposits is unavoidable. Therefore it is necessary to clean the chimney and the vertical venting pipes regularly in order to avoid or reduce them.

Cleaning is recommended at least once a year and even more often if the appliance is used daily and fuel with features different from those illustrated in section 1.4 is employed.

We recommend to let the cleaning process being realized by a professional chimney sweeper, ask the address to your dealer.

The sweeper's intervention may represent an effective and economic solution to protect the installation from corrosion and keep it in efficiency to grant those essential safety conditions that allow us to live with more serenity.

i Just before the beginning of the next season, particularly as regards unoccupied houses, we recommend checking the smoke channel and the chimney, in order to be sure that there is no clogging due to insects, birds or small mammals' nests.}

4.3 Putting your appliance out of service

When the appliance is not going to be used for a long time, usually at the end of the heating season, beside the routine maintenance procedures we recommend that you operate the appliance until the fuel is finished.

! IMPORTANT: Unplug the appliance once you have finished using it for the season.

4.4 Failures/ Causes / Trouble-shooting

There is no power to the appliance:

- The power cord may have been damaged or disconnected from the plug.
- The fuse located inside the electronic control unit could be blown (see section 4.4.1).

The appliance fails to start repeatedly:

- The door gaskets could be in bad condition.
- The combustion chamber may have not been submitted to the required routine maintenance works (see section 4.1.3).
- The ignition resistance or the smoke temperature sensor may be blown (have the service staff check the appliance).

The convection fan does not operate:

- The fan may be blown or blocked (have the service staff check the appliance).

Pellets build up in the burn pot and spill out:

- It may be necessary to modify the combustion parameters for pellet loading (see section 3.3.5 - Menu M8).
- The burn grate may be clogged (see section 4.1.3, figure 4).
- The appliance may have not been submitted to the required routine maintenance works (see sections 4.1.3 and 4.2). If the pellet used produces lots of combustion residues, it is absolutely necessary to reduce the time interval between routine maintenances of type B to no more than 250÷300 hours of use.
- The door gaskets could be in bad condition.
- There is insufficient combustion air (if the problem persists even after the appliance cleaning, have the service staff check the appliance).
- The smoke exhauster may not be working correctly (in this case have the service staff check the appliance).
- The fuel may be damp.
- The combustion air inlet may be obstructed.

There is smoke in the room:

- Check to see if the gaskets are in good condition.
- In the same room there could be another appliance working (stove, fireplace, wood cooker, suction hood) or not (open fireplace) whose draught may negatively affect that of your appliance or the reverse.
- The appliance may have not been submitted to the required routine maintenance works (see sections 4.1.3 and 4.2).
- Check to see if the exhaust system (pipe and chimney flue) is air-tight or needs to be cleaned out.
- Make sure that there is a good connection between the appliance and the chimney flue.
- The size of the chimney flue does not comply with the requirements in this manual (see sections 2.3.3 and 2.3.4).
- The first times the appliance is operated, the paint on the metal surfaces releases some smells. Simply aerate the room as necessary.
- Check to see if any impediment (plants, buildings) exceeds the height of the chimney cap thus preventing the smoke discharge.
- The draught in the chimney flue may not be adequate.

4.4.1 Replacement of fuse in service

If you press the switch at the back of the unit to the stand-by position and neither the switch light nor the display screen on the control panel will light up, check the fuse in service and if necessary make use of the replacement fuse.



WARNING: This work can only be done after the appliance has cooled completely and has been disconnected from the electrical power source (electrical plug disconnected).

To replace the service fuse, located by the connection to the supply cable, proceed as follows :

- Disconnect the supply cable and carefully take out the drawer with the service fuse [S] inside it (see figure 1).
- Check the integrity of the fuse.
- Replace the fuse, if it is blown, with a new one, fitting it in the reverse sequence.

Then plug in the power cord and press the main on/off switch again.

If the problem persists or the fuse should blow again, contact Customer Service.

Fuse Specifications: "5A T 5x20 (delay-fuse)".

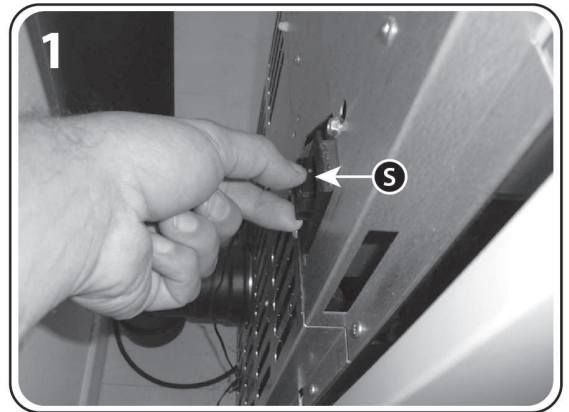

5 FOR THE AUTHORIZED SERVICE TECHNICIAN

5.1 Wiring-diagram



WARNING: Even after being switched off, the appliance is not disconnected from electrical power; therefore, before removing the cladding or the back panel and/or the screws holding the electronic control unit, always be sure to first unplug the power cord or turn off the circuit breaker.

PRACTICAL SCHEME LEGEND

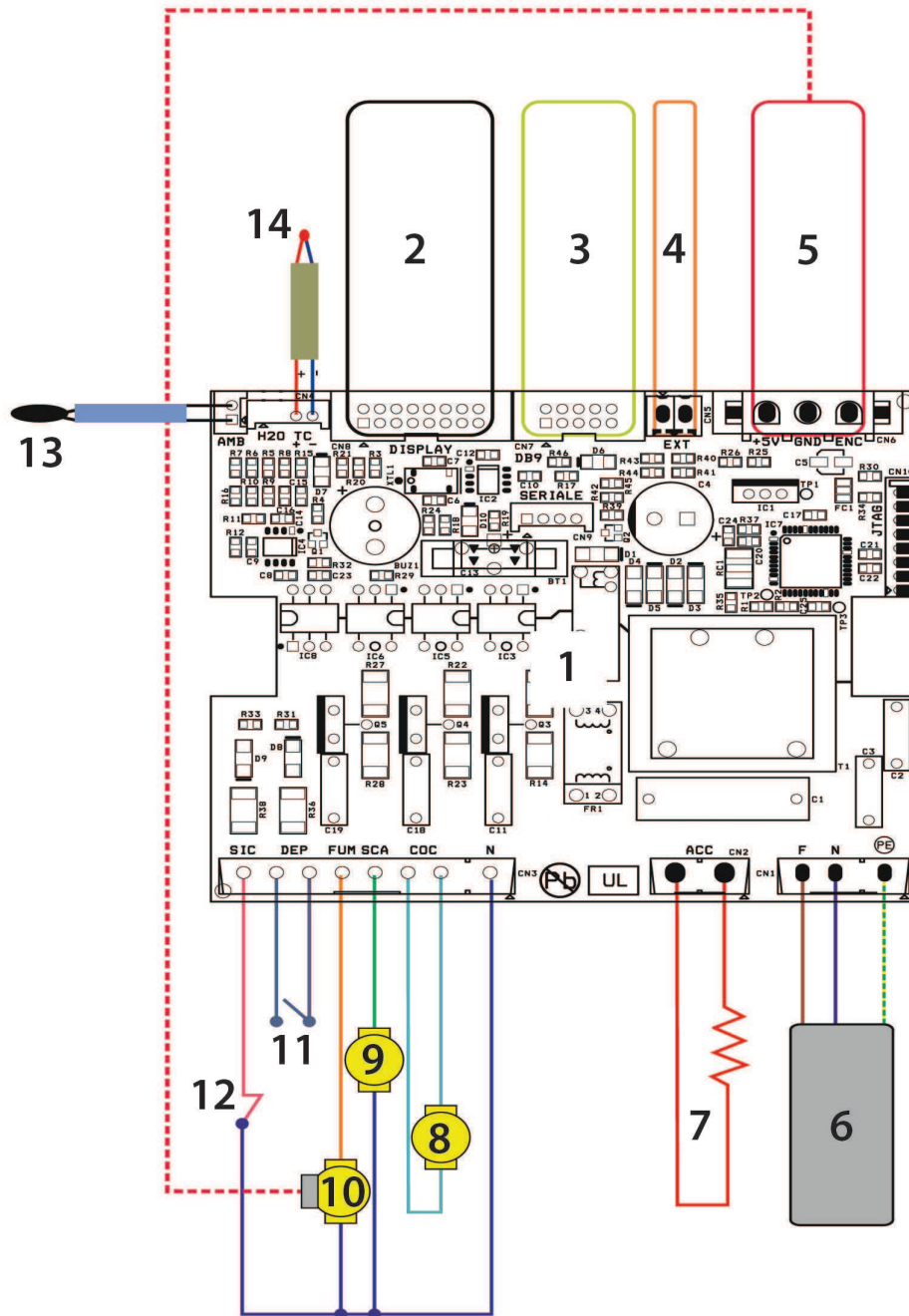

- 1. Electronic card
- 2. Control panel
- 3. Serial communication
- 4. External thermostat *
- 5. Encoder smoke extractor

- 6. Power supply 230 Vac
- 7. Ignition resistance
- 8. Screw auger geared motor
- 9. Convection fan
- 10. Smoke exhauster

- 11. Pressure controller
- 12. Thermostat
- 13. Room temperature sensor
- 14. Smoke sensor
- * Optional

5.2 Connection to a thermostat or to a switch

The appliance can be switched on and off by using a clean contact from a thermostat or an external switch connected to the appropriate terminal [M] on the electronic card of the appliance and setting the ambient temperature below 6°C (see section 3.3.4).

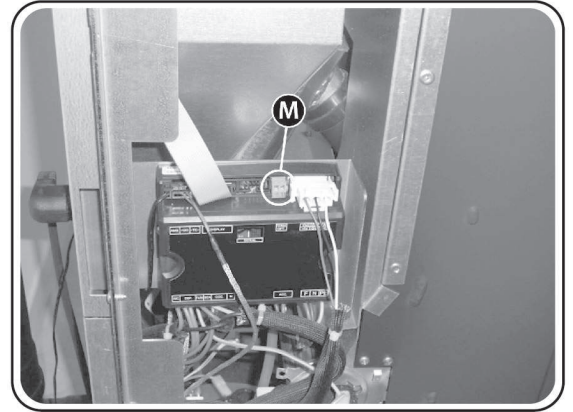

5.3 Servicing record

1	3
2	

1	3
2	

1	3
2	

1	3
2	

- 1. DATE
- 2. SIGNATURE OF SERVICING STAFF
- 3. SERVICING DESCRIPTION

The Company reserves the right to make any alterations resulting from any technical or commercial reasons it considers appropriate without notice and assumes no responsibility for any possible mistake or inaccuracies in this brochure. The reproduction in whole or in part of the photographs, drawings or texts is forbidden. Infringements will be punished by law. Data and measurements are provided purely as an indication.



Zone Industrielle Lieu-dit « La Gravette »
08350 DONCHERY – Francia
Tel. +33 0324 277171
www.invicta.fr