

M12 MALE 90° FIELD-WIREABLE SCREW TERM.5-pol. max.0,75mm² 4-6mm

Male 90°

M12, 5-pole

Screw terminals

Sealing range (cable Ø): 4...6 mm

Plastic housings with good resistance against chemicals and oils.

The resistance to aggressive media should be individually tested for your application. Further details on request.

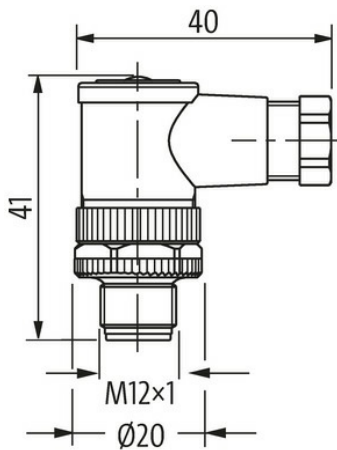
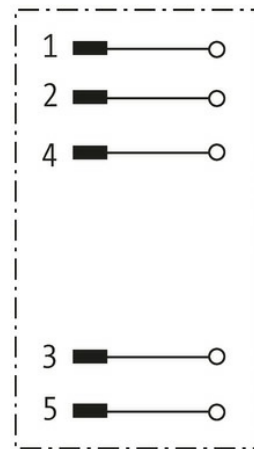
[Link to Product](#)**Illustration**

Male

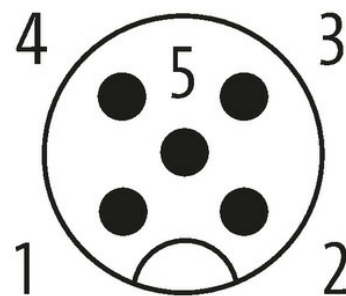

Product may differ from Image

**Form**

Form 12841

Technical Data

Operating voltage max. 60 V AC/DC

Operating voltage (only UL listed)	max. 125 V AC/DC
Rated surge voltage	1.5 kV
Operating current per contact	max. 4 A; max. 3 A (UL-Recognized)
Material group	III
Locking of ports	Screw thread (M12×1 mm) recommended torque 0.6 Nm, self-securing
Compression gland	M12 (SW18)
Connection cross section	max. 0.75 mm ²
Sealing range (cable Ø)	4...6 mm
Protection	IP67 inserted and tightened (EN 60529)
Over voltage category	II

General data

Pollution Degree	3
Temperature range	-40...+85 °C
Material (housing)	PA
Dimensions H×W×D	41×40×20 mm

Commercial data

country of origin	DE
customs tariff number	85366990
EAN	4048879201599
eClass	27279221
Packaging unit	1.000