

2PS 32

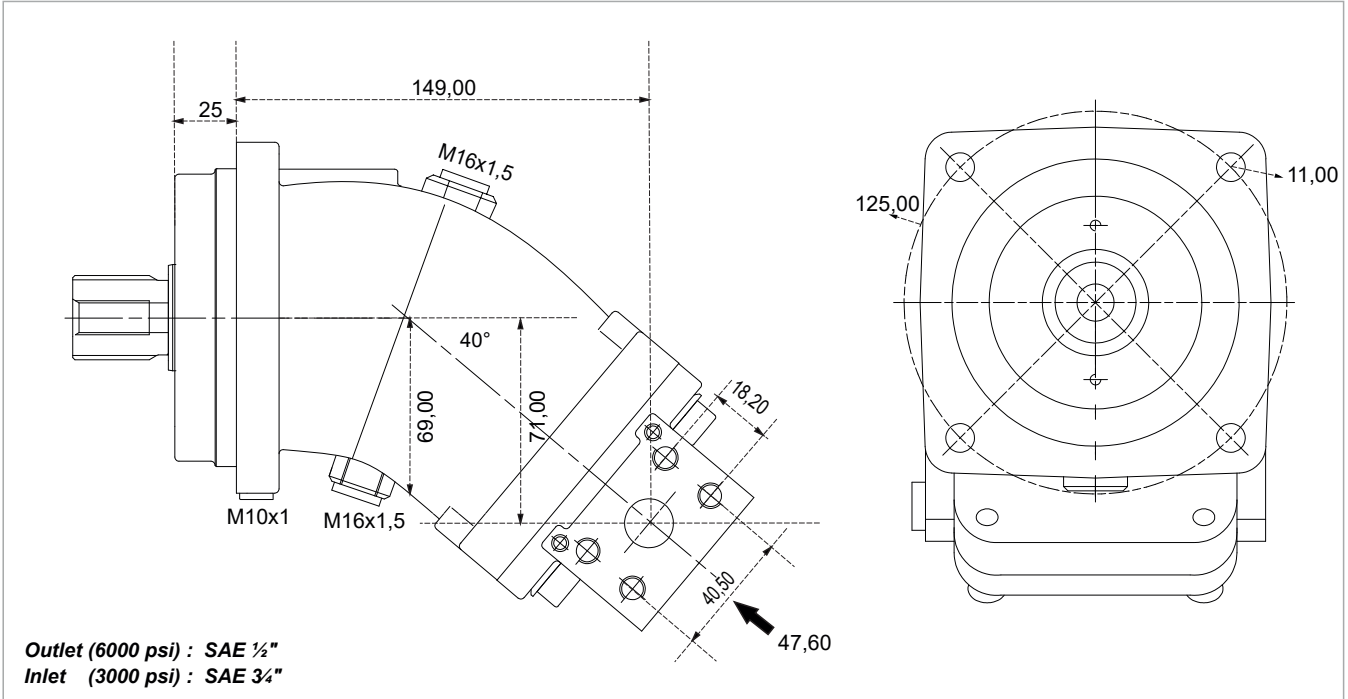

x 1000 rpm	32,00 cc
x 1500 rpm	48,00 cc
Max. Continuous Pump Speed	2500 rpm
Max. Continuous Pressure	400 bar
Max. Peak Pressure	450 bar
Max. Torque at 350 bar	174 Nm
Max. Flow	80,00 l/min.
Min. Pump Temperature	-25 °C
Max. Pump Temperature	110 °C
Weight without accessories	11,50 kg
Weight with accessories	11,90 kg
Rotation	CW-CCW

