

2PS 12

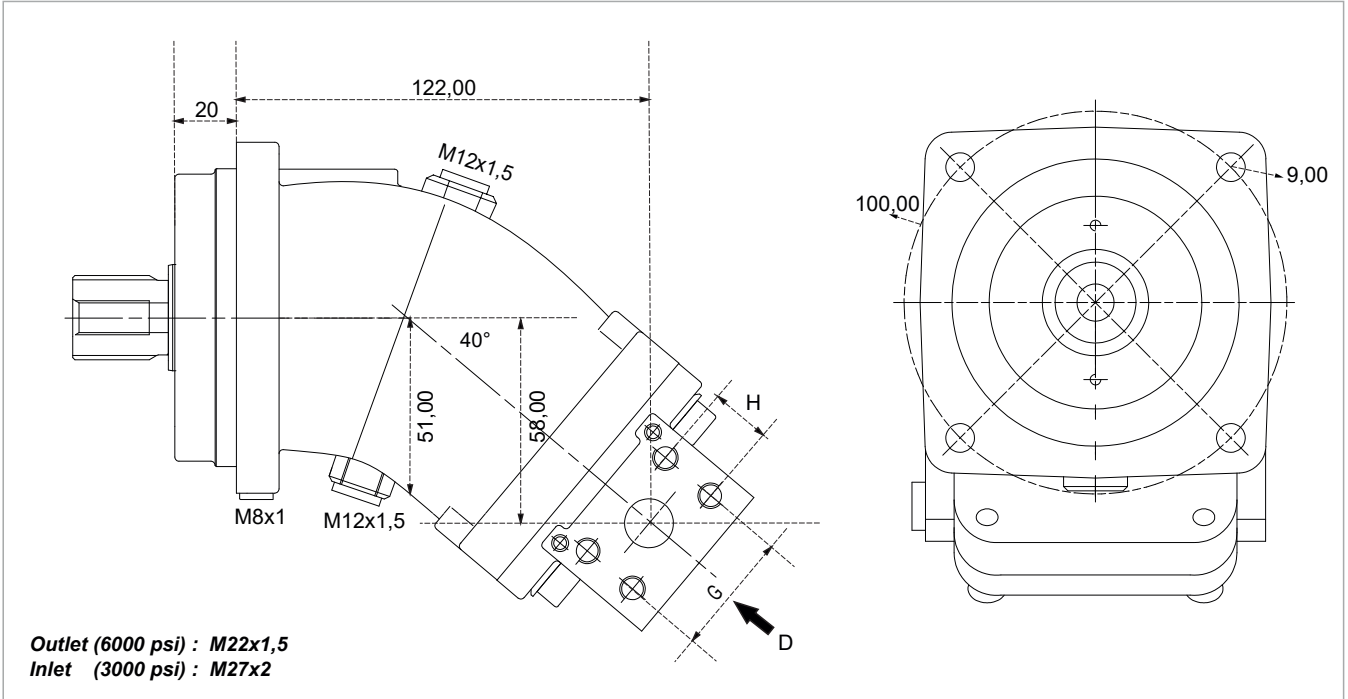

x 1000 rpm	12,00 cc
x 1500 rpm	18,00 cc
Max. Continuous Pump Speed	3100 rpm
Max. Continuous Pressure	400 bar
Max. Peak Pressure	450 bar
Max. Torque at 350 bar	66 Nm
Max. Flow	37,20 l/min.
Min. Pump Temperature	-25 °C
Max. Pump Temperature	110 °C
Weight without accessories	6,00 kg
Weight with accessories	6,20 kg
Rotation	CW-CCW

