

# 2PBA 80

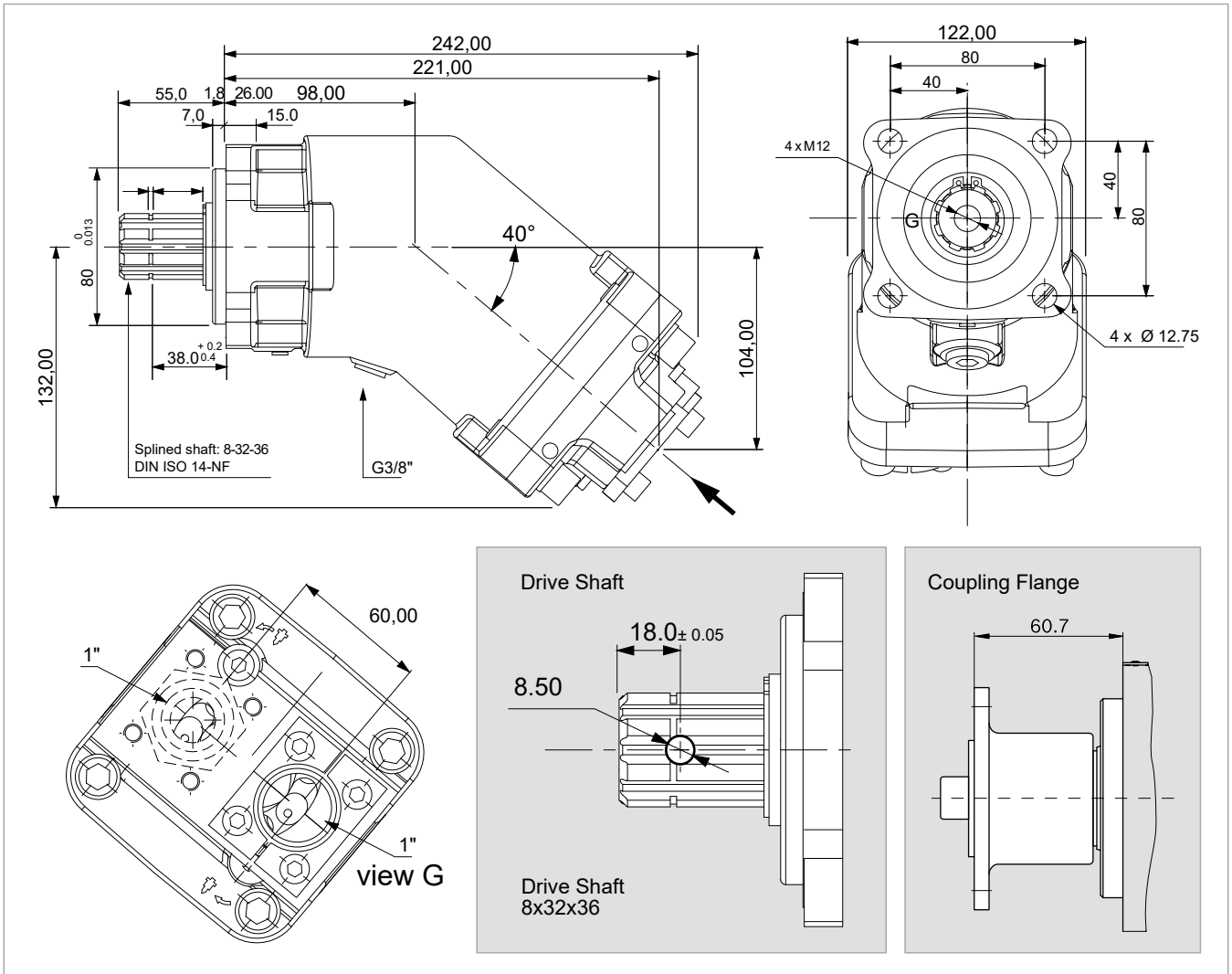

<b>x 1000 rpm</b>	80,00 cc
<b>x 1500 rpm</b>	120,00 cc
<b>Max. Continuous Pump Speed</b>	1700 rpm
<b>Max. Limited Pump Speed</b>	2100 rpm
<b>Max. Continuous Pressure</b>	350 bar
<b>Max. Intermit. Peak Pressure</b>	400 bar
<b>Max. Torque at 350 bar</b>	460 Nm
<b>Weight without inlet fitting</b>	15,00 kg
<b>Weight with inlet fitting</b>	15,40 kg
<b>Torque without inlet fitting</b>	17,80 N.m
<b>Torque with inlet fitting</b>	18,33 N.m
<b>Rotation</b>	CW-CCW
<b>Fluid</b>	Min.B.Hyd.Oil
<b>Inlet &amp; Outlet</b>	1"

Flow, Speed, Pressure List of 2PBA 80

