

2PS 63

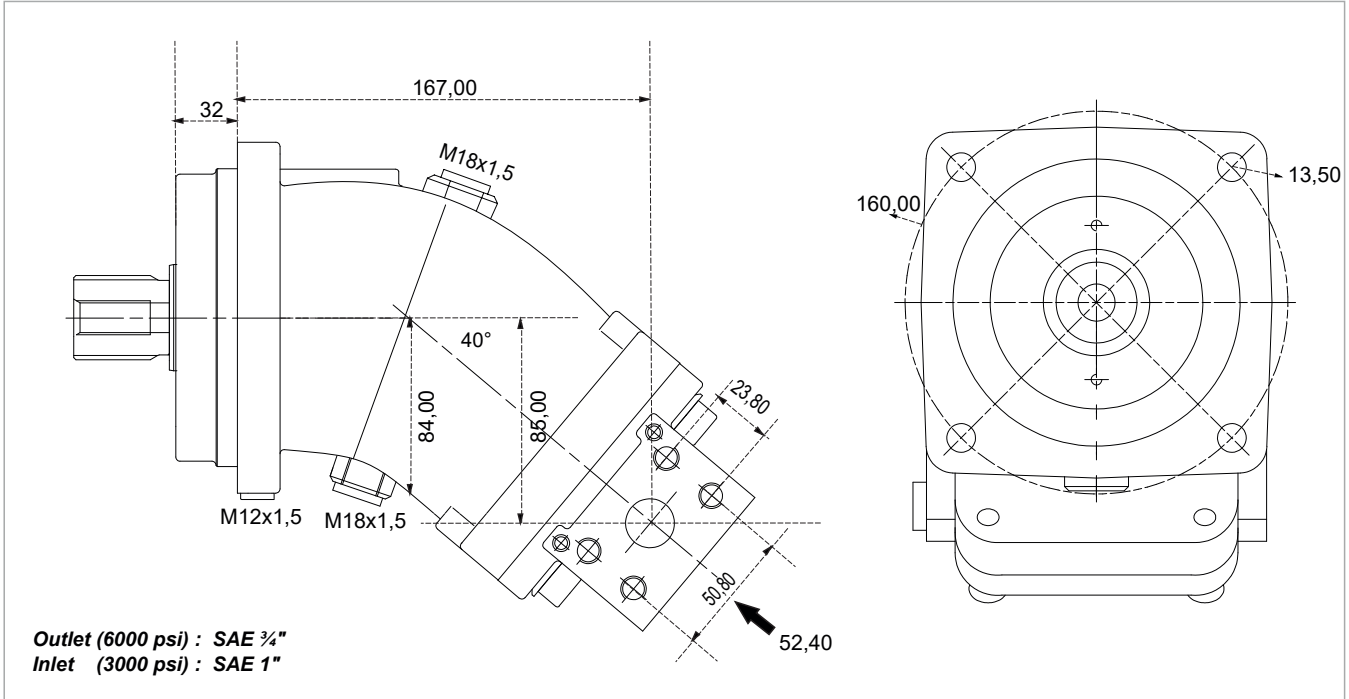

x 1000 rpm	63,00 cc
x 1500 rpm	94,50 cc
Max. Continuous Pump Speed	2300 rpm
Max. Continuous Pressure	400 bar
Max. Peak Pressure	450 bar
Max. Torque at 350 bar	350 Nm
Max. Flow	144,90 l/min.
Min. Pump Temperature	-25 °C
Max. Pump Temperature	110 °C
Weight without accessories	18,00 kg
Weight with accessories	18,50 kg
Rotation	CW-CCW

