

2PS 80

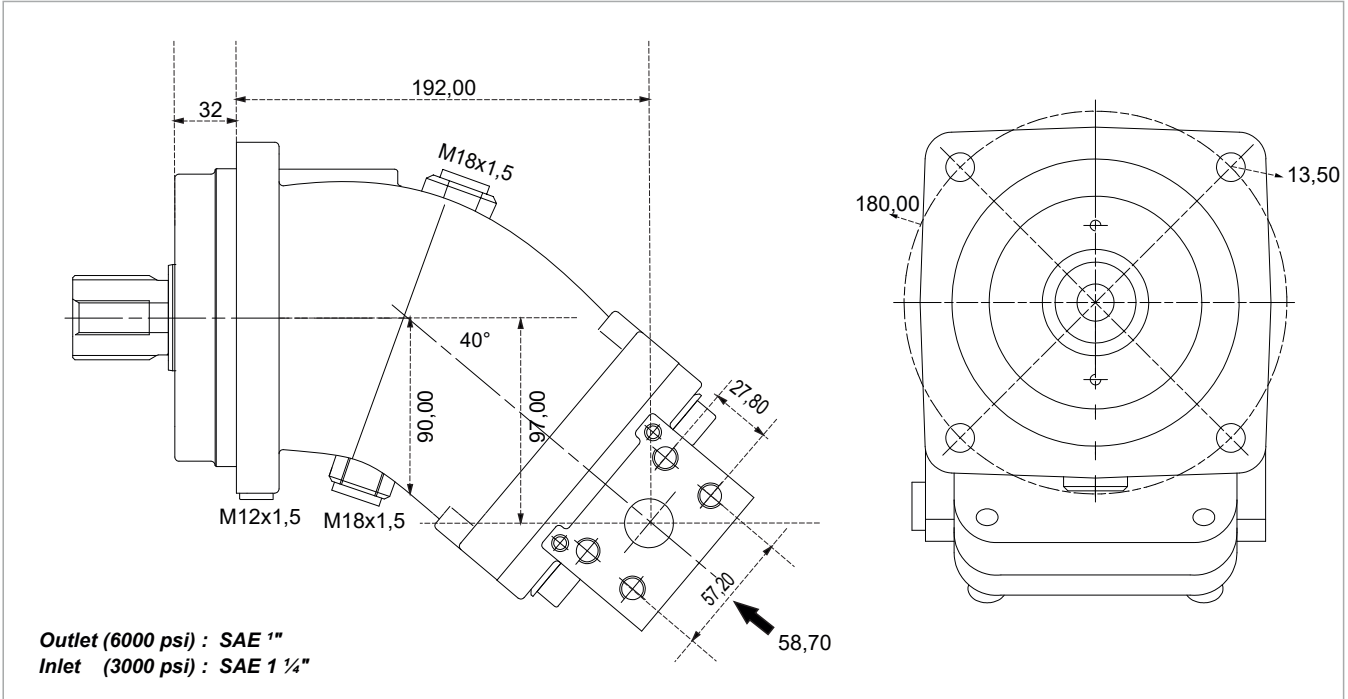

x 1000 rpm	80,00 cc
x 1500 rpm	120,00 cc
Max. Continuous Pump Speed	2300 rpm
Max. Continuous Pressure	400 bar
Max. Peak Pressure	450 bar
Max. Torque at 350 bar	445 Nm
Max. Flow	184,00 l/min.
Min. Pump Temperature	-25 °C
Max. Pump Temperature	110 °C
Weight without accessories	22,00 kg
Weight with accessories	22,50 kg
Rotation	CW-CCW

