

Hitachi Inverter

WJ200 / WL200 SERIES

WJ-PN (PROFINET communication option)

Quick Reference Guide

(The printed material doesn't exist.)

Table of Contents

Chapter 1	Introduction.....	1
Chapter 2	Outline	3
Chapter 3	Appearance.....	5
Chapter 4	Attachment.....	7
Chapter 5	Wiring, Connecting	11
Chapter 6	Setting.....	14
Chapter 7	Operation from the PROFINET.....	16
Chapter 8	PROFINET Specification	22
Chapter 9	Errors and Remedies	54
Chapter 10	WJ-PN Specification	62
Appendix	PROFINET Object List	64

Thank you for your purchase of “HITACHI INVERTER SERIES.” This Quick Reference Guide (QRG) outlines the handling of “WJ-PN (PROFINET Communication)” Refer to this manual and the instruction manual of the inverter for installation, maintenance, and inspection.

After reading this manual, keep it handy for future reference.

Be sure to deliver this manual to the end user.

After reading this manual, keep it handy for future reference.

HITACHI

NT355X

- Introduction -

Thank you for your purchase of “WJ-PN (PROFINET communication option)”

This Quick Reference Guide (QRG) outlines the handling and maintenance of “WJ-PN.” Before using the product, carefully read this QRG with the instruction manual of the inverter, and keep it handy for quick reference of the operator and maintenance inspector. Read this QRG carefully and follow the instructions exactly before installing, operating, maintenance and inspection.

Always keep various kinds of specifications mentioned in this QRG and use exactly. And make sure to prevent trouble by correct inspection and maintenance. Make sure to deliver this QRG to the end user.

- Usage of this QRG-

(1) Please understand that the mentioned items of this QRG may be changed without permission.

(2) All right reserved.

(3) Please understand, the functions that are not listed in this QRG shall mean "does not support it."

(4) If you find any incorrect descriptions, missing descriptions or have a question or inquiry concerning the contents of this QRG, please contact your Hitachi distributor.

(5) Please understand that we hold no responsibility for any resulting effects, in spite of the above mentioned contents.

- Trademark-

PROFINET is trade names of the non-profit organization PROFIBUS Nutzerorganisation e.V.(PNO).

- Reference-

Please refer to PROFINET concerning general information on the PROFIBUS and PROFINET International (PI):

URL <http://www.profibus.com/>

- Operation guarantee -

This option conforms to PROFINET, but Hitachi Industrial Equipment Systems Co.,Ltd. cannot guarantee that this option can be connected to all PROFINET IO controllers.

- WL200 -

WL200 is a product for Europe.

- Troubleshooting -

Please refer to chapter 9 in this QRG and the instruction manual of the PROFINET IO controller.

Revision History Table

No.	Revision contents	The date of issue	Engineering sheet No.
1.	Initial release of Quick Reference Guide	Oct. 2016	NT355AX

Outside of this table, only revised spelling mistakes, omitted words, and error in writing will be changed without notice.

SAFETY PRECAUTIONS

SAFETY PRECAUTIONS

Carefully read this QRG and all of the warning labels attached to the inverter before installing, operating, maintaining, and inspecting. Safety precautions are classified into “Warning” and “Caution” in this QRG.

 **WARNING** : Indicates a potentially hazardous situation which, if not avoided, can result in serious injury or death.

 **CAUTION** : Indicates a potentially hazardous situation which, if not avoided, can result in minor to moderate injury, or serious damage to the product

The situation described in  **CAUTION** may, if not avoided, lead to serious adverse results. Important safety measures are described in CAUTION (as well as WARNING) so be sure observe them. Notes are described in this QRG in “NOTE.” Carefully read the contents and follow them exactly.

CAUTION

In all the illustrations in this QRG, covers and safety devices are occasionally removed to describe the details. When the inverter is operated, make sure that the covers and safety devices are placed as they were specified originally and operate it according to the instruction manual of the inverter.

 **WARNING****Wiring:**

Wiring work shall be carried out by electrical experts.

Otherwise, there is a danger of electric shock, fire and/or damage of product.

Implement wiring after checking that the power supply is off.

Otherwise, there is a danger of electric shock and/or fire.

Be sure not to operate electrical equipment with wet hands.

Otherwise, there is a danger of electric shock and/or injury.

Do not damage cables caused by stress or sandwich.

Otherwise, there is a danger of electric shock.

Operating:

Please do not open the inverter' s case or optional case when the power supply is on and please do not carry out the following operations when the power supply is on.

- (1) Please do not touch the inside (ex. terminal parts).
- (2) Please do not check the internal signal.
- (3) Please do not put on or take off the internal wiring and connector.

Otherwise, there is a danger of electric shock and/or fire.

Do not touch the conductive parts such as the internal PCB, terminals or connector while power is being supplied.

Otherwise, there is a danger of electric shock.

Be sure not to remove this product while inverter is powered ON.

Otherwise, there is a danger of electric shock and/or fire.

Maintenance, Inspection and Part Replacement:

Wait at least 10 minutes after turning off the input power supply before performing maintenance and inspection.

(Confirm that charge lamp on the inverter is off, check the direct current voltage between P-N terminals and confirm it is less than 45V)

Otherwise, there is a danger of electric shock.

Make sure that only qualified persons perform maintenance, inspection, and part replacement. Before starting the work, remove metallic objects from your person (wristwatch, bracelet, etc.). Be sure to use tools protected with insulation.

Otherwise, there is a danger of electric shock and/or injury.

Please do not carry out insulation resistance (megger) and voltage proof test.

Otherwise, there is a danger of electric shock and/or a possibility that the product will get damaged.

NOTE:

Never disassemble / repair / modify the unit.

Otherwise, there is a danger of electric shock and/or injury.

CAUTION

Installation:

Be sure not to let foreign matter such as wire clippings, spatter from welding, metal shavings, dust etc. enter the unit.

Otherwise, there is a danger of fire.

Be sure to fix the inverter to this product with an attached fixed screw.

Otherwise, there is a danger of a connection error.

Be sure to fasten the screws connecting the signal wire inside of this product. Check for any loosening of screws.

Otherwise, there is a danger of a connection error.

Be sure that all cable connector screws are tightened to the torque specified in the relevant manuals.

Otherwise, tightening torque may result in malfunction.

In order to prevent damage caused by static electricity, Please remove the static electricity of the body touch the nearby metal before touching this product.

Otherwise, there is a possibility that the product will get damaged.

Please do not carry out insulation resistance (megger) and voltage proof test.

Otherwise, there is a danger of electric shock and/or a possibility that the product will get damaged.

Be careful of the followings.

- When removing WJ-PN, do not pull the PROFINET DP cable.
- When mounting WJ-PN, be sure that the PROFINET DP cable is not pinched.
- When mounting WJ-PN, be careful about burrs of the break-outs on the inverter.

Otherwise, there is a possibility that the product will get damaged.

Wiring:

Be sure to fasten the screws so they will not come loose.

Otherwise, there is a danger of a connection error.

Be sure that all cable connector screws are tightened to the torque specified in the relevant manuals.

Otherwise, tightening torque may result in malfunction.

Operation:

Check rotary direction, abnormal motor noise and vibrations during operation.

Otherwise, there is a danger of injury to personnel and/or machine breakage.

Check the Inverter's EzSQ program and its interaction with the PROFINET IO controller before actually running it on the Inverter.

Otherwise, there is a danger of injury to personnel and/or machine breakage.

If an unexpected phenomenon happens, please do not touch the product, the inverter and cable.

Otherwise, there is a danger of injury to personnel.

1.1 Check at the time of purchase

Make sure to treat the product carefully to prevent shock and vibration while unpacking and not to damage the connector to connect WJ-PN and a inverter.

Confirm that the product is the one you ordered, that there are no defects, and that there was no damage during transportation.

Contents:

(1) WJ-PN (PROFINET Communication option): 1 piece



(2) Basic Manual: 1 copy.

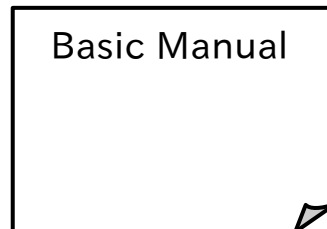

(3) Ferrite core: 2 pieces.



Specifications (recommended)

Name	Manufacturer	Model	Inner diameter
Ferrite core	SEIWA ELECTRIC MFG. Co., Ltd.	E04SR200935A	9 [mm]

If you find any problems, contact your sales agent immediately.

Please keep the original packing box/material and return all of them to investigate them by our side.

1.2 Inquiry of the product and warranty for the product

1.2.1 Required information for product inquiry

If an inquiry of breakage, a question, damage etc. is required, please relay the following information about WJ200 / WL200 and WJ-PN to the supplier that you ordered from or the nearest Hitachi Distributor.

- (1) Type (WJ200 / WL200 and WJ-PN)
- (2) Manufacturing number (MFG No.)
Please refer to the lateral specifications labels (the figure shows an example.) on the side.
- (3) Date of purchase
- (4) Contents of inquiry
 - Damaged parts and its condition etc.
 - Parts in question and their contents etc.

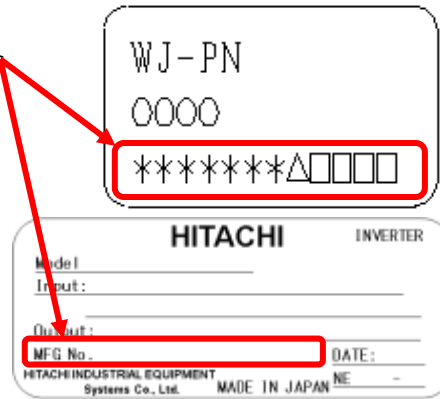

In order to shorten down time, utilizing a replacement unit is recommended.

1.2.2 Warranty of the product

The warranty period under normal installation and handling conditions shall be 2 years from the date of manufacture, or 1 year from the date of installation, whichever occurs first. The warranty shall cover the repair or replacement, at Hitachi's sole discretion, of ONLY the product that was installed.

1. Service in the following cases, even within the warranty period, shall be charged to the purchaser:
 - a. Malfunction or damage caused by miss-operation or modification or improper repair
 - b. Malfunction or damage caused by a drop after purchase and transportation
 - c. Malfunction or damage caused by fire, earthquake, flood, lightning, abnormal input voltage, contamination, or other natural disasters
2. When service is required for the product at your work site, all expenses associated with field repair shall be charged to the purchaser.

Always keep this manual handy; please do not lose it. Please contact your Hitachi distributor to purchase replacement or additional manuals.

2.1 Outline of product

WJ-PN is an interface option of PROFINET communication for WJ200 / WL200. WJ-PN allows controlling, monitoring and parameterization of WJ200 / WL200 via the PROFINET network.

PROFINET is an open, digital communication system. PROFINET is anchored in the international standards IEC 61158 and IEC 61784.

WJ-PN supports the application profile PROFIdrive version 4.2. This profile defines device behavior and the access procedure to drive data for electric drives on PROFINET or PROFINET.

(1) PROFINET

WJ-PN supports PROFINET IO Ver.2.32.

The conformance class of WJ-PN is B.

(2) Cyclic communication

The PROFINET IO controller manages the PROFINET network, and performs PROFINET IO device status monitoring and data exchange with the PROFINET IO devices.

The format of communication data conforms to PROFIdrive.

Output data (to PROFINET IO device) : operation command, target value, etc.

Input data (to PROFINET IO controller) : operation status, present value, etc.

(3) Setting the inverter parameters

You can set the inverter parameters by using acyclic communication of the PROFINET.

The procedure to access parameters conforms to PROFIdrive.

2.2 About optional correspondence of WJ200 / WL200

You can attach WJ-PN to all models of WJ200 / WL200. However, it may not support WJ-PN depending on the product version. Please refer to the inverter specifications label on the side and check its version (it is mentioned in the top right corner) on specifications label. (The figure shows an example.)

WJ200/WL200 of the version listed in the table below is compatible with WJ-PN.

Series	Version
WJ200	Ver.2.4 or later
WL200	Ver.1.0E or later

Please confirm the version.

The diagram shows a rounded rectangular label for a Hitachi inverter. At the top center is the word "HITACHI" in large, bold, black letters. To the right of "HITACHI" is the word "INVERTE" in smaller, bold, black letters. Below "INVERTE" is the text "Ver.2.4" in bold, black letters, which is circled in red. An arrow points from the text "Please confirm the version." above to this circled text. Below "HITACHI" are several lines of text, each followed by a horizontal line for input: "Model:", "Input:", "Output:", "MFG No.", and "DATE:". At the bottom left of the label, it says "HITACHI INDUSTRIAL EQUIPMENT Systems Co., Ltd." and at the bottom right, it says "MADE IN JAPAN NE -".

2.3 About limitations of using WJ-PN

When you use WJ-PN, be aware of the following limitations:

- Modbus communication is not usable.
- Functional safety (STO) certification of the inverter becomes ineffective.

3.1 Appearance and each part name

The following is the external description of WJ-PN. For more information about LEDs and connectors, please refer to the page mentioned.

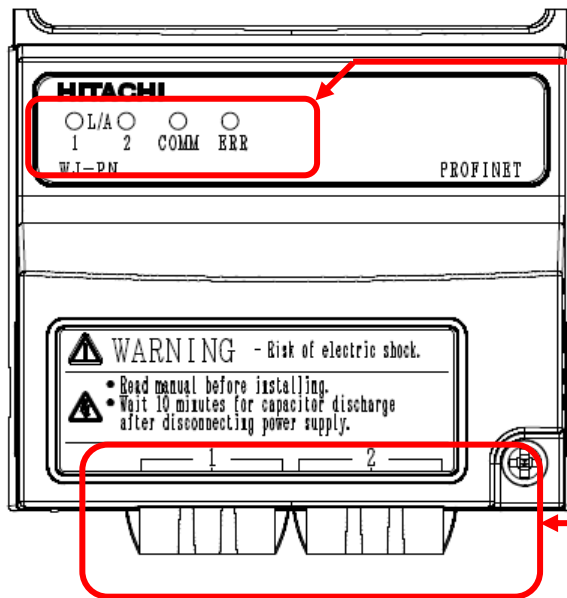

LEDs:

These LEDs describe PROFINET states.

From left side:

- L / A 1
- L / A 2
- COMM
- ERR

Connectors:

You can connect the option to the PROFINET network via these connectors. Connector type is RJ-45, electrical characteristics conform to IEEE802.3 standard.

The left side is port 1, and the right side is port 2.

NOTE:

Please fix the connected PROFINET cables to prevent mechanical failure by the vibration/gravity.

Install the ferrite core (included in shipment) on the LAN cables (both port 1 and 2) near the connectors.

3.2 Summary of all parts

3.2.1 LED

The summaries of LED, the setting switch and the connector are as follows.

Please refer to “9.1 Status indicator explanations and error handling” for details.

Name	Color	Description
L / A 1	Green	ON : Link is established.
L / A 2		Blinking : Activity. OFF : No link is established.
COMM	Green	ON : WJ-PN is communicating with PROFINET IO controller by the set telegram. Blinking : WJ-PN starts communicating with PROFINET IO controller, and is setting to communicate with PROFINET IO controller by the set telegram. OFF : WJ-PN doesn't communicate with PROFINET IO controller by the set telegram.
ERR	Red	ON : WJ-PN detects hardware error. Blinking : WJ-PN detects communication timeout. OFF : WJ-PN doesn't detect any errors.

COMM and ERR LED are switched on from power on until WJ-PN has finished startup.

3.2.2 Connector

Name	Description
PROFINET connector port 1	This is connected to the PROFINET network.
PROFINET connector port 2	
Grounding cable	Wire the ground cable. NOTE: Please be sure to do it.

Please refer to Chapter 5 ‘Wiring, Connecting’ for the specifications and the wiring.

4.1 Before attaching WJ-PN

First of all, please confirm that the inverter's main power supply is OFF. Next, please confirm that the 4-digit 7-segment display turns off the light.

Perform the main circuit wiring of the power line (power supply, motor, grounding, BRD), and do the control circuit wiring of the signal line. After wiring on main and control circuit is completed, please confirm that the inverter works normally before attaching WJ-PN.

Please refer to Chapter 2 'Inverter Mounting and Installation' of the WJ200 / WL200 instruction manual for the wiring.

4.2 Attachment procedure

The connection procedure of WJ-PN as follows.

(An example: in the case of WJ200-004LF)

(Main circuit electric wiring and the control circuit electric wiring are omitted.)

The initial state.



Please remove the optional board cover.



Chapter 4 Attachment

Please remove the terminal block cover.

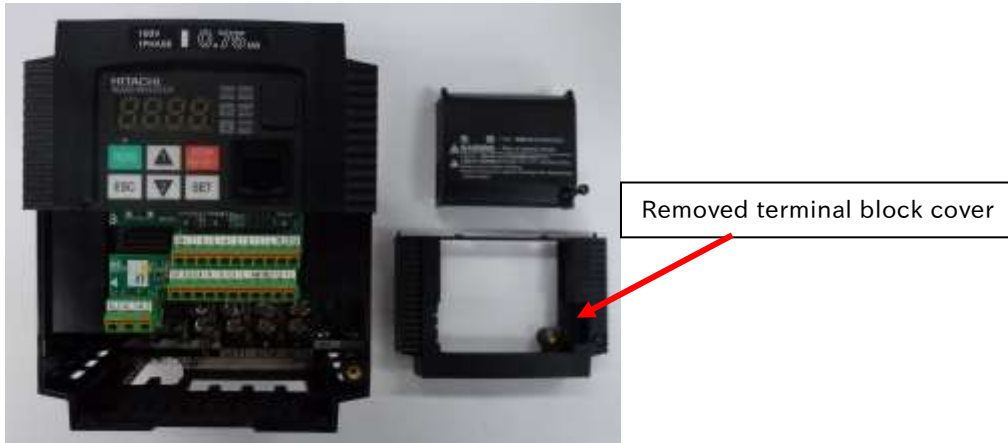

Please remove the housing partition.

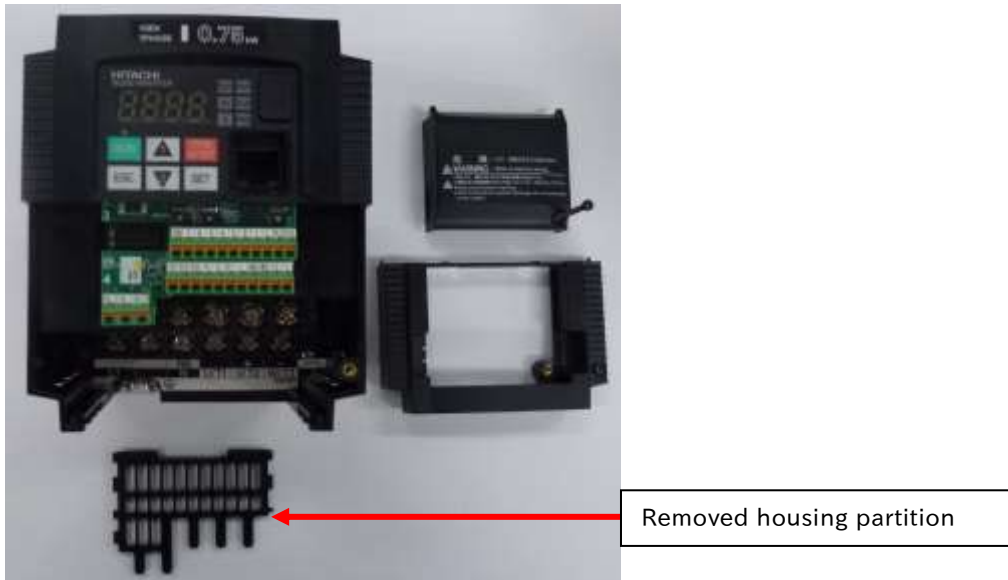

Please wire the grounding cable.

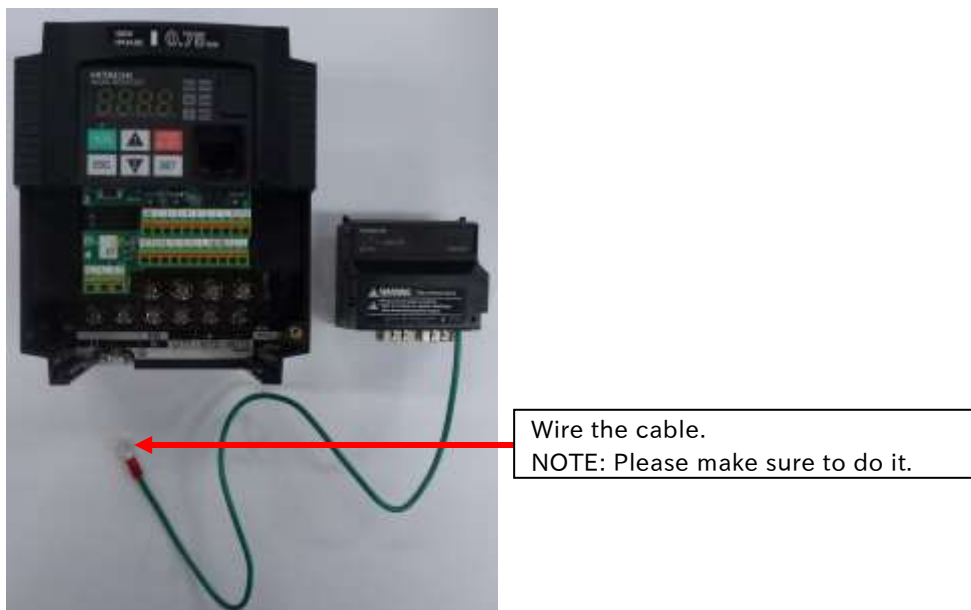

Reattach the housing partition and terminal cover. (Option board cover is not used in this case.)

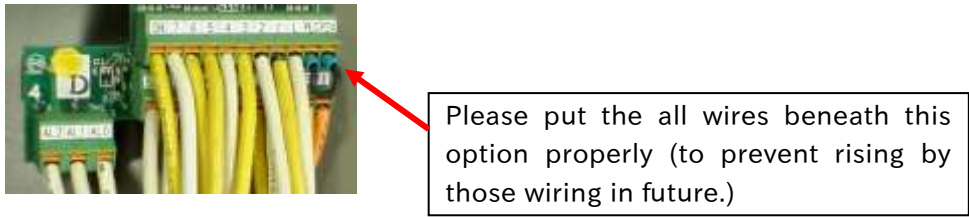
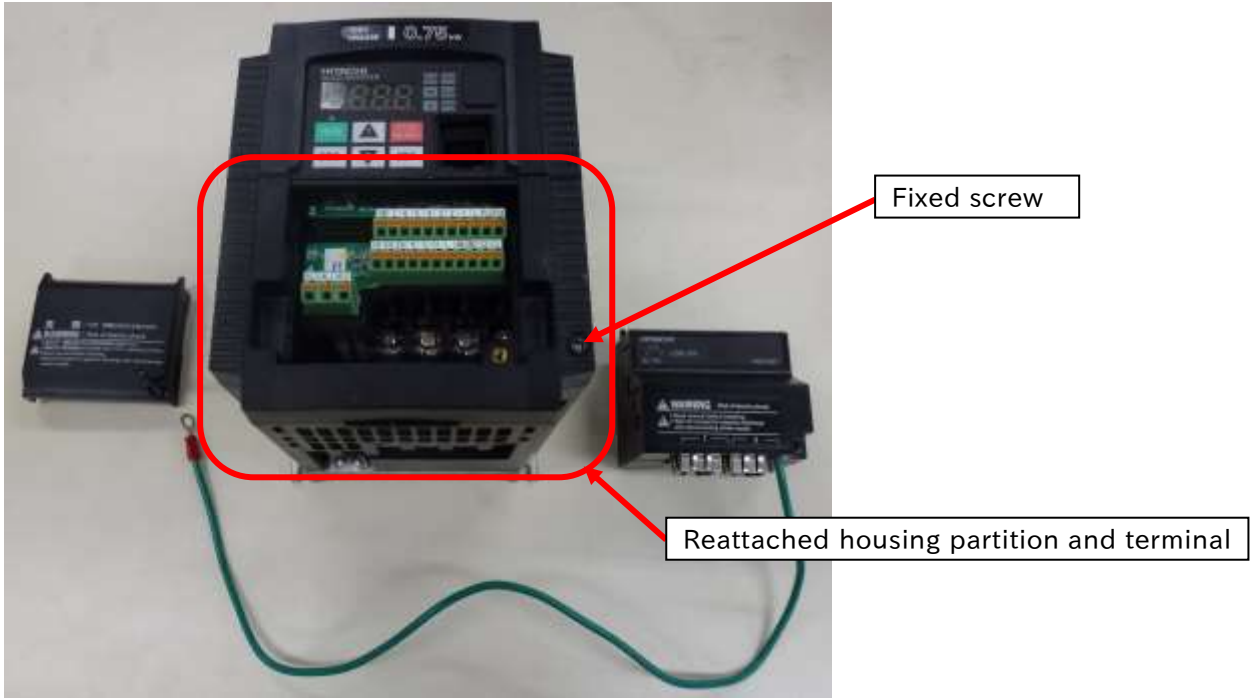

NOTE: in above pictures, the length of ground cable is not suitable. To avoid pulling the cable unintentionally, you need to cut the ground cable to an appropriate length for the distance to the inverter's grounding terminal and the size of the terminal block, and crimp the cable to the crimp terminal before using.

Chapter 4 Attachment

Lift the WJ-PN, and, please attach the installation connector (for WJ-PN) carefully and slowly from the front of the installation connector for the option of the WJ200 / WL200. Be careful to make the connectors straight and not to break the hooks



Fix the option with the screws.

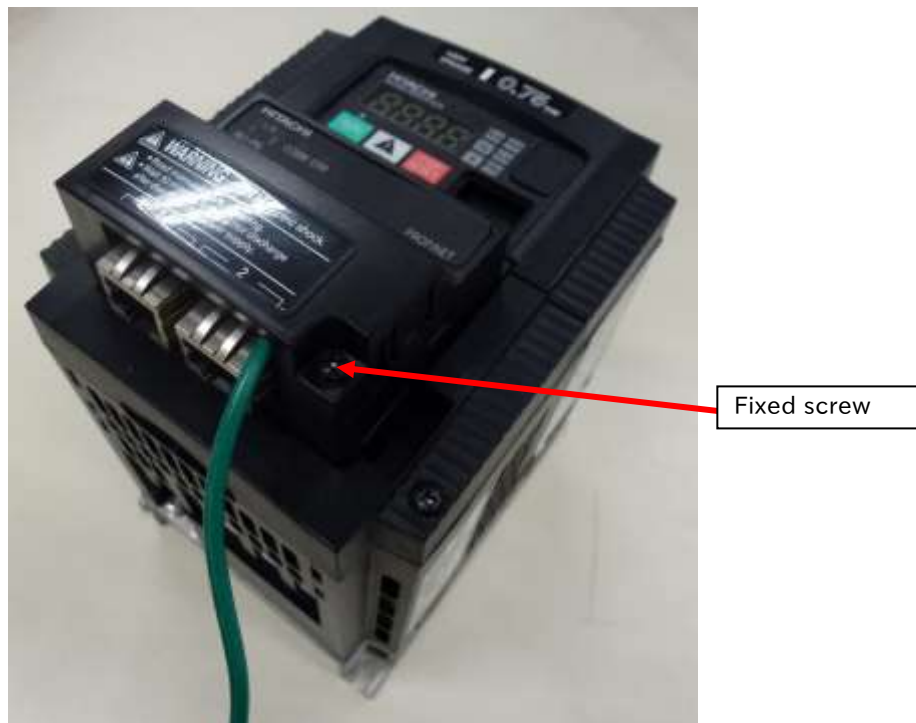

Please check the connection state of the WJ-PN and the WJ200 / WL200 inverter via the connector. When the connection state of the connector is bad, the Option error (inverter communication error, code: E6*, please refer to Chapter 9) may occur after supplying power to the inverter. Or, because the inverter cannot recognize an option, normal communication may not be carried out.

NOTE: Please install the inverter in a grounded metal cabinet.

5.1 Specification of PROFINET connector

Connector type	Description
RJ-45	Screwless type, the flange is with a screw

The Appearance and the wiring are the following.

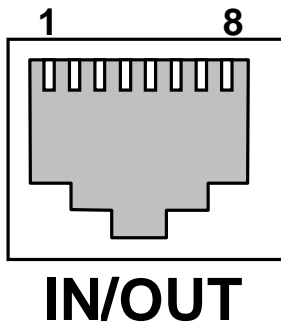

Pin number	Symbol	Type of signal
1	TD+	Send data+
2	TD-	Send data-
3	RD+	Receive data+
4	—	
5	—	
6	RD-	Receive data-
7	—	
8	—	

5.2 Specification of PROFINET cable

If an Ethernet cable of category 5e or higher is used, communications will be possible even if the cable is not shielded. However, we recommend the following cable to ensure sufficient noise immunity.

Name	Description
Twisted-pair cable	100BX-TX supported (category 5e or higher) STP cable (straight or cross allowed)
RJ-45 connector	Category 5e or higher, shielding supported

5.3 A system configuration of the PROFINET

The following sketch is an example of PROFINET system configuration.

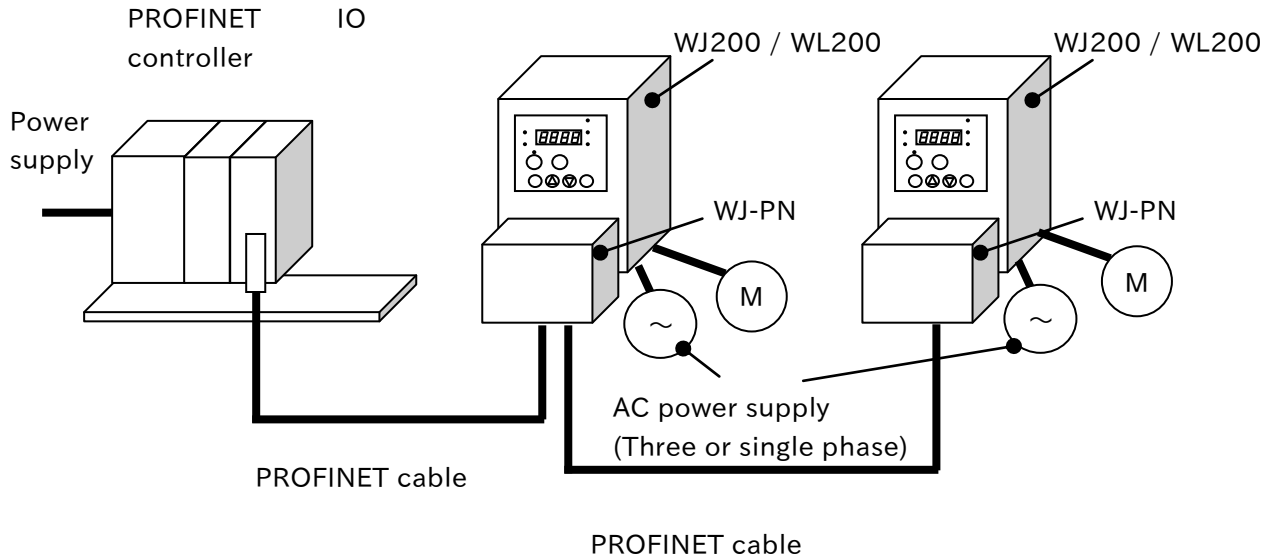

- (1) When you wire the signal line to the PROFINET connection connector, take the connector off WJ-PN and please wire it in the state that cut the communication power supply. WJ-PN may be damaged by false contact.
- (2) Network cables should be fixed without tension. Cables fixed under tension have the potential of causing a communication fault by removing a connector.
- (3) The communication line and the power line should wire the position that they separated as much as possible. When the position of the power line is near the communication line, it may not communicate by a noise.
- (4) Ensure external emergency stop measures are taken to stop the inverter, in the event of a network fault.
 - (a) Break the power supply of the Inverter when the network PROFINET IO controller detects a communication fault.
 - (b) When the PROFINET IO controller detects a communication fault, turn on the intelligent input terminal which would be allocated (FRS), (RS) and/or (EXT) function.
 - (c) Setting command P045 (Inverter action on communication error). Regarding this setting, the inverter is tripped, deceleration or free run stop when it detects a communication fault by itself. (Factory initialization of command P045 (Inverter action on communication error) is tripped. e.g. WJ200 / WL200 becomes the trip when a PROFINET IO controller detects a communication fault when WJ200 / WL200 runs by an order from the PROFINET.)

-About SAFETY-

When WJ200 / WL200 is used with Dip-Switch in the position to activate functional safety and communication PROFINET IO controller unit detects the communication error, please turn "OFF (to interrupt the output)" GS1 signal (intelligent input #3) and GS2 (intelligent input #4.) It is to be noticed that approval by third party for "STO" function is void even if the safety function is activated with Dip-Switch in the position to select functional safety (STO) when WJ-PN is attached to WJ200 / WL200.

For more details, please refer to the instruction manual of WL200 / WL200.

5.4 Install the ferrite core

Install the ferrite core (included in shipment) on the LAN cables (both IN and OUT) near the communications connectors. (If the communications cable on the OUT side is not connected, install the ferrite core for the IN side only.)



NOTE: Please fix the connected LAN cables.

6.1 Precautions for use

Check the Inverter settings for proper Inverter behavior before actually operating the Inverter remotely via the network.

The product will be used to control an adjustable speed drive connected to high voltage sources and rotating machinery that is inherently dangerous if not operated safely. Interlock all energy sources, hazardous locations, and guards in order to restrict the exposure of personnel to hazards. The adjustable speed drive may start the motor without warning. Signs on the equipment installation must be posted to this effect.

A familiarity with auto-restart settings is a requirement when controlling adjustable speed drives. Failure of external or ancillary components may cause intermittent system operation, i.e., the system may start the motor without warning or may not stop on command. Improperly designed or improperly installed system interlocks and permissions may render a motor unable to start or stop on command.

6.2 Setup of the WJ200 / WL200 for commissioning

Before commissioning, prepare the Inverter and WJ-PN by following the setting example below.

6.2.1 Setting of the inverter mode (When WJ200 / WL200 is connected to standard IM.)

Set the Inverter mode to Std. IM by first setting b171 = 1 and then b180 = 1.

When WJ200 / WL200 is connected to PM, you need to set b171 = 3.

6.2.2 Initialization of the inverter

First of all, please set b084 to 04(Clears trip history and initializes all parameters and EzSQ program), next set b085 to 01(area A), and then set b094 to 00(All parameters), and next set b180 to 01(Perform initialization), and then initialization of the inverter will be started.

6.2.3 Constant Torque mode/Variable Torque mode selection

In case of WJ200, Set b049 to 00 (b049 = 00: Constant Torque mode).

In case of WL200, you don't need to set b049 because WL200 supports only Constant Torque mode and doesn't support b049.

After the above-mentioned setting is completed, please set the parameter A001, A002, A004, A038, A039, A093, b031, C001 - C007, C042, C043, C102, P044, P045, P160 - P179 and P200 according to the table in "7.2: Parameter setting of WJ200 / WL200". When you set parameters with Operator or PC (ProDriveNext), you need to turn OFF the inverter. After the power supply of the inverter becomes OFF, please turn ON the inverter and check that WJ-PN communicates by PROFINET.

Please refer to data example of the WJ200 / WL200 operating in the PROFINET communication from the next page.

6.3 Operation with frequency command [Hz]

Please refer to the instruction manual of the PROFINET IO controller about the way of using it.

For a detailed description of the PROFINET communication, please refer to Chapter 8. The following is an example of operation with the Standard telegram 1 in the PROFINET communication and setting A004 to 50 [Hz].

STW1 is the control word. ZSW1 is the status word. NSOLL_A means the setting of output frequency. NIST_A means the actual output frequency.

[Setpoint (PROFINET IO controller -> PROFINET IO device)]

- ① Setting STW1 to 0x0406.
- ② Setting STW1 to 0x0407.
- ③ Setting STW1 to 0x047F.
- ④ Setting NSOLL_A to 0x4000 (100%).
- ⑤ Setting NSOLL_A to 0x1000 (25%).
- ⑥ Setting NSOLL_A to 0x0 (0%).
- ⑦ Setting NSOLL_A to 0xC000 (-100%).
- ⑧ Setting NSOLL_A to 0x0 (0%).

[Actual value (PROFINET IO device -> PROFINET IO controller)]

- ⑨ Stopping state, PROFIdrive transition to “Ready For switching On” .
- ⑩ Stopping state, PROFIdrive transition to “Switching On” .
- ⑪ Driving with 0x0 (0% : 0[Hz]) state, PROFIdrive transition to “Operation” .
- ⑫ Accelerating in forward direction, “XXXX” indicates NIST_A during acceleration.
- ⑬ Driving at a constant speed state, NIST_A is equal to 0x4000 (100% : 50[Hz]).
- ⑭ Deceleration state, “XXXX” indicates NIST_A during deceleration.
- ⑮ Driving at a constant speed state, NIST_A is equal to 0x1000 (25% : 12.5[Hz]).
- ⑯ Deceleration state, “XXXX” indicates NIST_A during deceleration.
- ⑰ Driving at a constant speed state, NIST_A is equal to 0x0 (0% : 0[Hz]).
- ⑱ Accelerating in reverse direction, “XXXX” indicates NIST_A during deceleration.
- ⑲ Driving at a constant speed state, NIST_A is equal to 0xC000 (-100% : -50[Hz]).
- ⑳ Deceleration state, “XXXX” indicates NIST_A during deceleration.
- ㉑ Driving at a constant speed state, NIST_A is equal to 0x0 (0% : 0[Hz]).

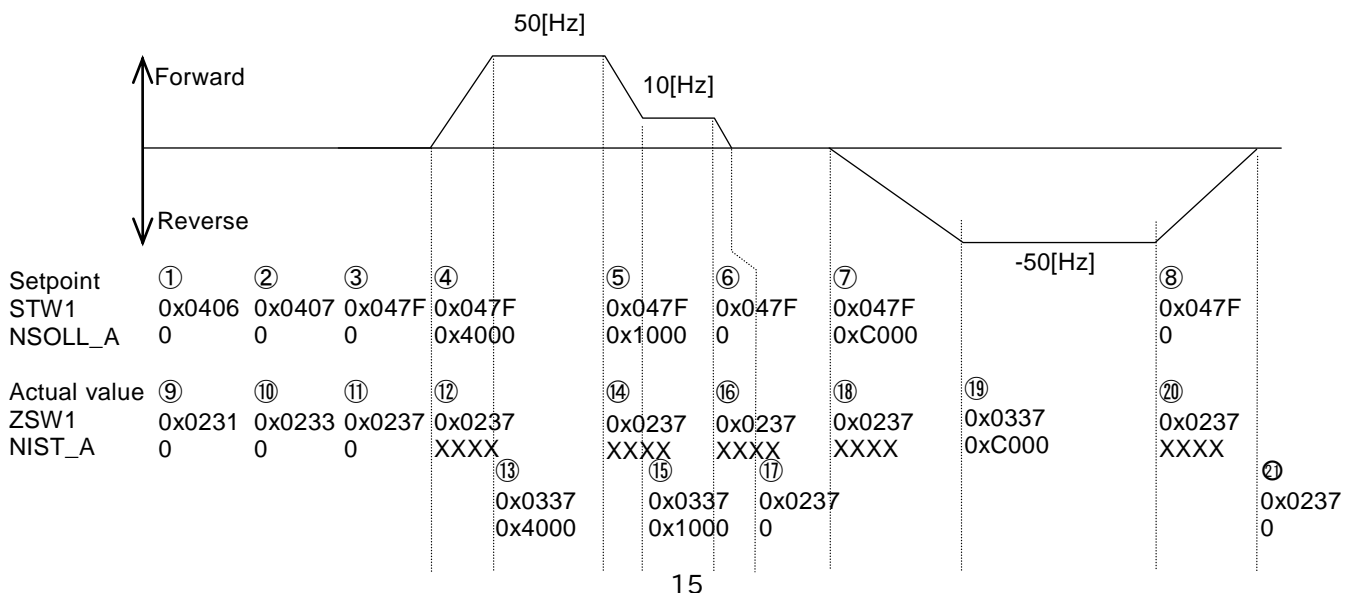

7.1 Installation of the GSDML File

It is necessary to install the GSDML File to your PC tool (Engineering tool) of PROFINET IO controller to use WJ-PN. GSDML file is a file that contains specific information of the PROFINET IO devices.

Please inquire to the nearest business contact about the GSDML file.

7.2 Parameter settings of WJ200 / WL200

WJ-PN needs the parameter settings of WJ200 / WL200, which shows the following table. Concerning the operating of the system, it is necessary to refer to the instruction manual of the inverter and the QRG of this option. Please perform appropriate settings as needed.

Parameter settings

Function code	Name	Value and description	Default	Run mode edit	High level access mode
A001	Frequency source	04: option	02	×	×
A002	Run command source	04: option	02	×	×
A004	Maximum frequency	Optional Settable from the base frequency to 400(580) Hz	60.0	×	×
A038	Jog frequency	Optional Defines limited speed for jog, range is from start frequency to 9.99 Hz	6.00	○	○
A039	Jog stop mode	Optional Define how end of jog stops the motor; six options: 00 : Free-run stop (invalid during run) 01 : Controlled deceleration (invalid during run) 02 : DC braking to stop (invalid during run) 03 : Free-run stop (valid during run) 04 : Controlled deceleration (valid during run) 05 : DC braking to stop(valid during run)	04	×	○

Function code	Name	Value and description	Default	Run mode edit	High level access mode
A093	Deceleration time (2)	Optional Duration of 2nd segment of deceleration, range is: 0.00 to 3600 sec.	10.00	○	○
b031	Software lock mode selection	10: High level access including b031	01	×	○
C001 - C007	Input [1-7] function	Except 06: JG		×	○
C005	Input [5] function	09: 2CH, Frequency output uses 2nd-stage deceleration value.	09	×	○
C006	Input [6] function	83: HLD, Frequency output uses 2nd-stage acceleration and deceleration values.	18	×	○
C042	Frequency arrival setting for acceleration	Optional Sets the frequency arrival setting threshold for the output frequency during acceleration, range is 0.0 to 400.0(580.0) Hz	0.0	×	○
C043	Frequency arrival setting for deceleration	Optional Sets the frequency arrival setting threshold for the output frequency during deceleration, range is 0.0 to 400.0(580.0) Hz	0.0	×	○
C102	Reset selection	03: Clear the memory only related to trip status	00	○	○
P044	Communication watchdog timer (for option)	Optional Set range is 0.00 to 99.99s	1.00	×	×

Chapter 7 Setting

Function code	Name	Value and description	Default	Run mode edit	High level access mode
P045	Inverter action on communication error (for option)	Optional 00 : Tripping 01 : Tripping after decelerating and stopping the motor 02 : Ignoring errors 03 : Stopping the motor after free-running 04 : Decelerating and stopping the motor	00	×	×
P160 - P169	Option I/F command register to write 1 to 10	Optional 0x0000 to 0xFFFF	0x0000	○	○
P170 - P179	Option I/F command register to read 1 to 10	Optional 0x0000 to 0xFFFF	0x0000	○	○
P200	Register Mapping setting (WJ200 Ver.3.0 or later)	00 : Standard Mapping function disabled	00	×	○

NOTE: You need to set b037 (display limited) to 00 (all parameters displayed).

7.2.1 A001 (Frequency source)

You need to set A001 to 04 in the case of operation WJ200 / WL200 using the PROFINET communication.

7.2.2 A002 (Run command source)

You need to set A002 to 04 in the case of operation WJ200 / WL200 using the PROFINET communication.

7.2.3 A004 (Maximum frequency)

The range of frequency that you can monitor or set is from -100% to 100% in PROFIdrive. You need to set base frequency.

7.2.4 A038 (Jog frequency)

WJ-PN supports Jog mode in Operation status of PROFIdrive. You need to set jog frequency.

7.2.5 A039 (Jog stop mode)

You need to set how the inverter stops. “00” is same as “03” (Free run stop), “01” is same as “04” (Controlled deceleration), “02” is same as “05” (DC braking to stop).

7.2.6 A093 (Deceleration time (2))

You need to set deceleration time when you use quick stop and C005 to 09 (2ch).

7.2.7 b031 (Software lock mode selection)

You need to set b031 to 10 (changeable mode during driving), if you rewrite the mutable parameters of the WJ200 / WL200 during operation by the PROFINET communication. If you have not already set to 10 (changeable mode during driving), it cannot be rewritten even after the rewrite of the parameters.

7.2.8 C001 - C007 (Input [1-7] function)

You need to set C001 - C007 expect 06 (JG). If you set 06 (JG), Jog mode doesn't work normally.

7.2.9 C005 (Input [5] function)

You need to set C005 to 09 (2CH), if you use the settings of the two-stage acceleration and deceleration during the deceleration in the Quick stop of CiA402. WJ200 / WL200 normally decelerates when you use quick stop of the two-stage acceleration and deceleration without the above setting.

7.2.10 C006 (Input [6] function)

You need to set C006 to 83 (HLD), if you use the freeze ramp generator function that STW1 bit5 is OFF. If you don't set C006 to 83 and STW1 bit5 is OFF, output frequency isn't freeze.

7.2.11 C042 (Frequency arrival setting for acceleration)

When the output frequency is over the frequency that is set to C042 during acceleration, ZSW1 bit10 becomes ON. If you set C042 to 0, ZSW1 bit10 doesn't become ON.

7.2.12 C043 (Frequency arrival setting for deceleration)

When the output frequency is over the frequency that is set to C043 during deceleration, ZSW1 bit10 becomes ON. If you set C043 to 0, ZSW1 bit10 doesn't become ON.

7.2.13 C102 (Reset selection)

You need to set 03 (release at tripping) to C102. This parameter decides the WJ200 / WL200's action when the reset terminal (RS) is ON.

If you set C102 to 00 (release at ON), 01 (release at OFF), or 02 (enable at tripping), WJ-PN is reset at reset terminal (RS) input and WJ200 / WL200 displays E60 (option error). If you set 03 (clear tripping state only), WJ-PN is not reset terminal (RS) input and WJ200 / WL200 can continue driving after released from tripping.

7.2.14 P044 (Communication watchdog timer (for option))

You need to set P044 to the communication watchdog timer. This communication watchdog timer is different from the watchdog of PROFINET. This communications watchdog timer starts the time measuring after the watchdog of PROFINET occurs. In case that the watchdog of PROFINET occurs and then WJ-PN restarts communicating with PROFINET IO controller within time have been set in P044, WJ-PN doesn't detect communication error. If you set P044 to 0, WJ-PB doesn't monitor non communication.

7.2.15 P045 (Inverter action on communication error (for option))

You need to set P045 to inverter action on communication error.

7.2.16 P160 - P169 (Option I/F command register to write 1 to 10)

You need to set P160 - P169 to Modbus register no when you use telegram 103, 104 or 105. Please refer to "8.12.2 WJ-PN telegram 103 to 105" for details.

7.2.17 P170 - P179 (Option I/F command register to read 1 to 10)

You need to set P170 - P179 to Modbus register no when you use telegram 103, 104 or 105. Please refer to "8.12.2 WJ-PN telegram 103 to 105" for details.

7.2.18 P200 (Register Mapping setting)

This parameter exists in WJ200 Ver.3.0 or later.

You need to set P200 to 00 when you use WJ-PN.

7.3 Selecting of the frequency source

Showing below an association map of the frequency source choice of the WJ200 / WL200 series inverter (include WJ-PN). Please refer to an instruction manual of the WJ200 / WL200 about the detailed contents except WJ-PN.

NOTE: Modbus communication is not usable. WL200 doesn't support Pulse train input [EA].

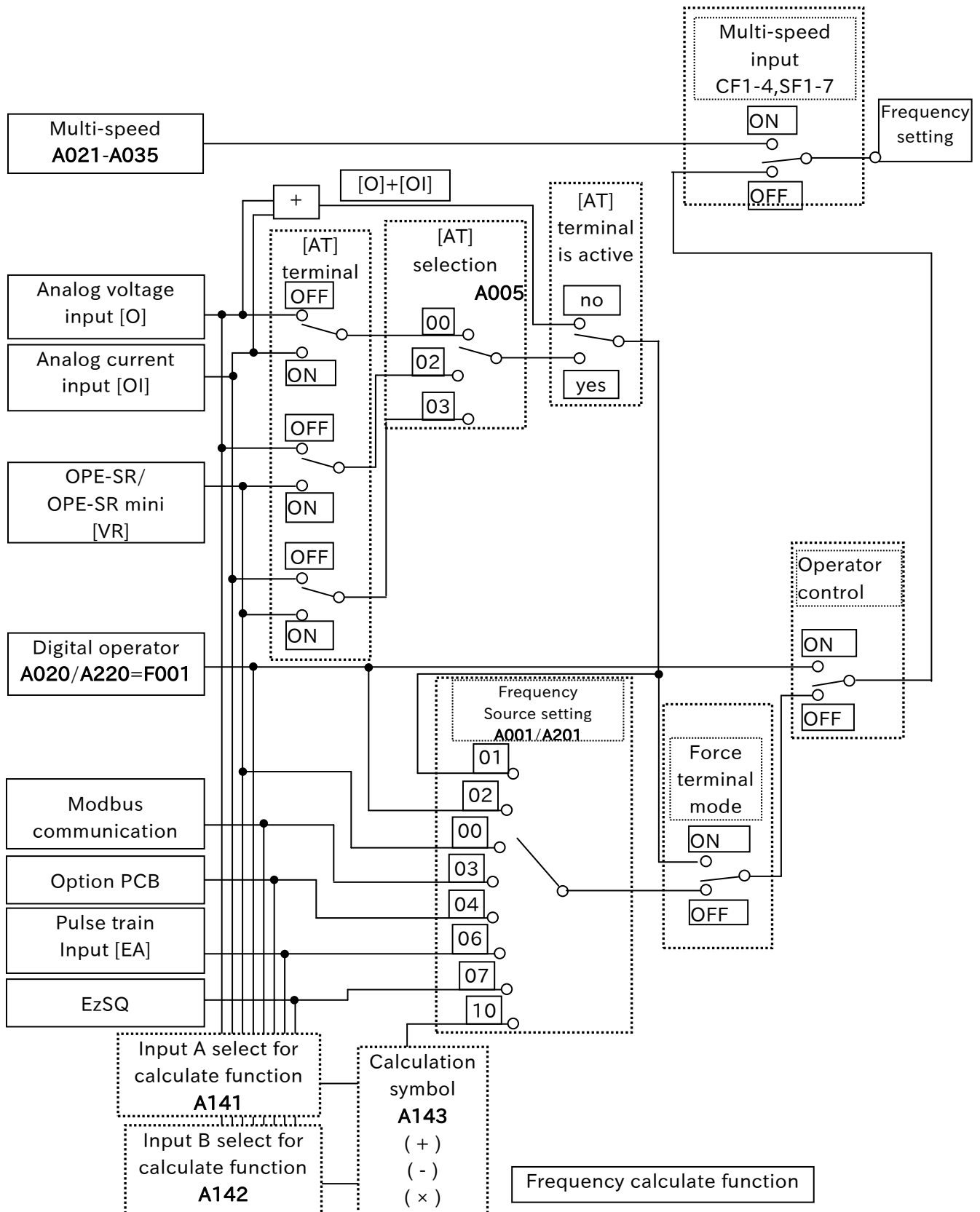

8.1 PROFINET

Specifications for WJ-PN are the following.

Item	Specification
Communications protocol	PROFINET IO Ver2.32
Device type	PROFINET IO Device
Conformance class	B
Protocol	DCP (Discovery and basic Configuration Protocol) LLDP (Link Layer Discovery Protocol) SNMP (Simple Network Management Protocol)
Netload	I
RT / IRT	only RT
Profile	PROFIdrive
LLDP Support TLV	chassis ID port ID Time To Live LLDP_PNIO_PORTSTATUS LLDP_PNIO_CHASSIS_MAC LLDP8023MACPHY LLDPManagement End TLV
SNMP Support MIB	MIB-2 LLDP-MIB LLDP-EXT-PNIO-MIB LLDP-EXT-DOT3-MIB
Physical layer	Auto negotiation (100BASE-TX (IEEE802.3) only)
port	2 ports
MAC address	3 (Host, Port 1 / 2)

8.2 Device Name (NameOfStation) and IP address

You need to set device name (NameOfStation) and IP address to WJ-PN with engineering tool. Please refer to the manual of the engineering tool for the usage.

8.3 MAC address

WJ-PN has 3 MAC addresses of host, port1, and port2.

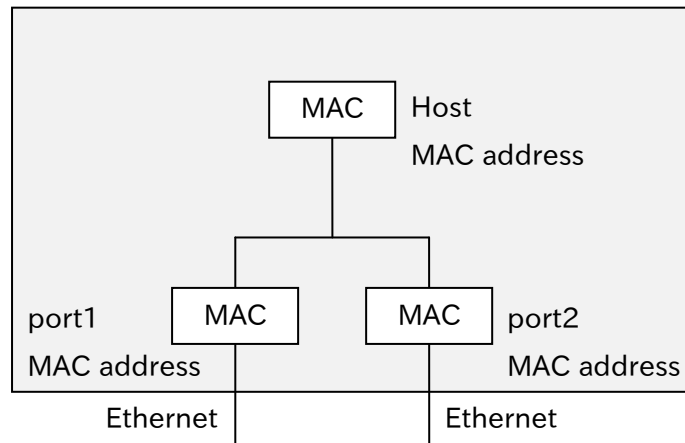

8.4 LLDP

LLDP (Link Layer Discovery Protocol) is a function to transmit own device information to the neighbor devices at a fixed interval.

LLDP packet consists of multiple TLV (type-length-value). A TLV consists of 3 fields (type, length, and value) and expresses a kind of information. In the case of following figure, length is n.

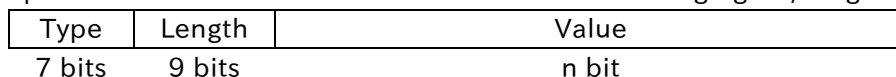

Please refer to the following subsection about the details of TLV of WJ-PN, and IEEE802.1AB-2009 about LLDP.

8.4.1 chassis ID

This data indicates the WJ-PN information.

Item		Length	Value
Type		7 bits	1
Length		9 bits	n+1
Value	chassis ID subtype	1 byte	4 : MAC address of this port 7 : Device name (NameOfStation)
	chassis ID	n bytes	When the device name (NameOfStation) is set to WJ-PN, this data is device name (NameOfStation). When the device name (NameOfStation) isn't set to WJ-PN, this data is MAC address of this port.

8.4.2 port ID

This data indicates the port information at which WJ-PN transmits LLDP packet.

Item		Length	Value
Type		7 bits	2
Length		9 bits	9
Value	port ID subtype	1 byte	7
	port ID	8 bytes	port 1 : port-001 port 2 : port-002

8.4.3 Time To Live

This data indicates the seconds which is retention time.

Item		Length	Value
Type		7 bits	3
Length		9 bits	9
Value	Time To Live	1 byte	20

8.4.4 LLDP_PNIO_PORTSTATUS

This data is particular TLV to PROFINET, and indicates the PROFINET port information.

Item		Length	Value
Type		7 bits	0x7F
Length		9 bits	8
Value	OUI	3 bytes	0x00 0x0E 0xCF
	subtype	1 byte	2
	RTClass2 port status	2 bytes	0
	RTClass3 port status	2 bytes	0

OUI (Organizationally Unique Identifier) is the unique identifier. OUI which is 0x00 0x0E 0xCF indicates PROFINET.

WJ-PN doesn't support RTClass2 and RTClass3.

8.4.5 LLDP_PNIO_CHASSIS_MAC

This data is particular TLV to PROFINET, and indicates the device information.

Item		Length	Value
Type		7 bits	0x7F
Length		9 bits	10
Value	OUI	3 bytes	0x00 0x0E 0Xcf
	subtype	1 byte	5
	MAC address	6 bytes	MAC address of host

8.4.6 LLDP8023MACPHY

This data is particular TLV to IEEE802.3 (Ethernet), and indicates the information about Ethernet. OUI which is 0x00 0x12 0x0F indicates IEEE802.3.

Item	Length	Value
Type	7 bits	0x7F
Length	9 bits	9
Value	OUI	3 bytes 0x00 0x12 0x0F
	subtype	1 byte 1
	auto negotiation	1 byte 3 Bit 0 indicates that WJ-PN supports Auto negotiation. Bit 1 indicates that Auto negotiation is active.
	transmission speed	2 bytes 0x0400 Bit 11 indicates that WJ-PN supports 100BASE-TX. The other bits indicate that WJ-PN doesn't support the other transmission speed.
	actually transmission speed	2 bytes 0x0010 This indicates that the transmission speed is 100BASE-TX Full.

8.4.7 LLDPManagement

This data indicates the management information. OID (Object Identifier) is enterprise number of PI.

Item	Length	Value
Type	7 bits	8
Length	9 bits	20
Value	Management address length	1 byte 5
	Management address subtype	1 byte 1
	Management address	4 bytes IP address
	Interface numbering subtype	1 byte 2
	Interface number	4 bytes 1
	OID length	1 byte 8
	OID	8 bytes 0x2B 0x06 0x01 0x04 0x01 0x81 0xC0 0x6E This indicates that OID is '1.3.6.1.4.1.24686'.

8.4.8 End

This data indicates the end of LLDP packet.

Item	Length	Value
Type	7 bits	0
Length	9 bits	0

8.5 SNMP

Please refer to following section about the OIDs (Object Identifier) that WJ-PN supports. The “access” and “type” shall be as follows.

[Access]

Access	Meaning
R	Read only
W	Write only
RW	Read and write
N	Not accessible

[Type]

Data type	Expression in tables	Meaning
Integer	INT*	Singed integer. “*” indicates bit length.
Octet string	OS[*]	Byte strings. “*” indicates the number of characters. No “*” means read only data.
Object identifier	OID	Object identifier
IpAddress	IpAddress	IP address. This is Octet string has 4 characters.
Counter32	Counter32	From 0 to 4294967295.
Unsigned32	UINT32	From 0 to 4294967295.
Gauge32	Gauge32	From 0 to 4294967295.
TimeTicks	TimeTicks	From 0 to 4294967295. This indicates the time in hundredths of a second between two epochs.
Opaque	Opaque	Octet string
Counter64	Counter64	From 0 to 18446744073709551615.

8.5.1 MIB-2

OID	Object name	Access	Type
1.3.6.1.2.1.1.1	sysDescr	R	OS
1.3.6.1.2.1.1.2	sysObjectID	R	OID
1.3.6.1.2.1.1.3	sysUpTime	R	TimeTicks
1.3.6.1.2.1.1.4	sysContact	RW	OS[255]
1.3.6.1.2.1.1.5	sysName	RW	OS[255]
1.3.6.1.2.1.1.6	sysLocation	RW	OS[255]
1.3.6.1.2.1.1.7	sysServices	R	INT
1.3.6.1.2.1.2.1	ifNumber	R	INT32
1.3.6.1.2.1.2.2	ifTable	N	
1.3.6.1.2.1.2.2.1	ifEntry	N	
1.3.6.1.2.1.2.2.1.1	ifIndex	R	INT32
1.3.6.1.2.1.2.2.1.2	ifDescr	R	OS
1.3.6.1.2.1.2.2.1.3	ifType	R	INT
1.3.6.1.2.1.2.2.1.4	ifMtu	R	INT32
1.3.6.1.2.1.2.2.1.5	ifSpeed	R	Gauge32
1.3.6.1.2.1.2.2.1.6	ifPhysAddress	R	OS[6]
1.3.6.1.2.1.2.2.1.7	ifAdminStatus	R	INT
1.3.6.1.2.1.2.2.1.8	ifOperStatus	R	INT
1.3.6.1.2.1.2.2.1.9	ifLastChange	R	TimeTicks
1.3.6.1.2.1.2.2.1.10	ifInOctets	R	Counter32
1.3.6.1.2.1.2.2.1.11	ifInUcastPkts	R	Counter32
1.3.6.1.2.1.2.2.1.12	ifInNUcastPkts	R	Counter32
1.3.6.1.2.1.2.2.1.13	ifInDiscards	R	Counter32
1.3.6.1.2.1.2.2.1.14	ifInErrors	R	Counter32
1.3.6.1.2.1.2.2.1.15	ifInUnknownProtos	R	Counter32
1.3.6.1.2.1.2.2.1.16	ifOutOctets	R	Counter32
1.3.6.1.2.1.2.2.1.17	ifOutUcastPkts	R	Counter32
1.3.6.1.2.1.2.2.1.18	ifOutNUcastPkts	R	Counter32
1.3.6.1.2.1.2.2.1.19	ifOutDiscards	R	Counter32
1.3.6.1.2.1.2.2.1.20	ifOutErrors	R	Counter32
1.3.6.1.2.1.2.2.1.21	ifOutQLen	R	Gauge32
1.3.6.1.2.1.2.2.1.22	ifSpecific	R	OID

8.5.2 LLDP-MIB

OID	Object name	Access	Type
1.0.8802.1.1.2	lldpMIB	N	
1.0.8802.1.1.2.1	lldpObjects	N	
1.0.8802.1.1.2.1.1	lldpConfiguration	N	
1.0.8802.1.1.2.1.1.7	lldpConfigManAddrTable	N	
1.0.8802.1.1.2.1.1.7.1	lldpConfigManAddrEntry	N	
1.0.8802.1.1.2.1.1.7.1.1	lldpConfigManAddrPortsTxEnable	R	OS[1]
1.0.8802.1.1.2.1.3	lldpLocalSystemData	N	
1.0.8802.1.1.2.1.3.1	lldpLocChassisIdSubtype	R	INT

Chapter 8 PROFINET Specification

OID	Object name	Access	Type
1.0.8802.1.1.2.1.3.2	IldpLocChassisId	R	OS[255]
1.0.8802.1.1.2.1.3.3	IldpLocSysName	R	OS[255]
1.0.8802.1.1.2.1.3.4	IldpLocSysDesc	R	OS[255]
1.0.8802.1.1.2.1.3.5	IldpLocSysCapSupported	R	OS[1]
1.0.8802.1.1.2.1.3.6	IldpLocSysCapEnabled	R	OC[1]
1.0.8802.1.1.2.1.3.7	IldpLocPortTable	N	
1.0.8802.1.1.2.1.3.7.1	IldpLocPortTableEntry	N	
1.0.8802.1.1.2.1.3.7.1.1	IldpLocPortNum	N	INT32
1.0.8802.1.1.2.1.3.7.1.2	IldpLocPortIdSubtype	R	INT
1.0.8802.1.1.2.1.3.7.1.3	IldpLocPortId	R	OS[255]
1.0.8802.1.1.2.1.3.7.1.4	IldpLocPortDesc	R	OS[255]
1.0.8802.1.1.2.1.3.8	IldpLocManAddrTable	N	
1.0.8802.1.1.2.1.3.8.1	IldpLocManAddrEntry	N	
1.0.8802.1.1.2.1.3.8.1.1	IldpLocManAddrSubtype	N	INT
1.0.8802.1.1.2.1.3.8.1.2	IldpLocManAddr	N	OS[31]
1.0.8802.1.1.2.1.3.8.1.3	IldpLocManAddrLen	R	INT32
1.0.8802.1.1.2.1.3.8.1.4	IldpLocManAddrIfSubtype	R	INT
1.0.8802.1.1.2.1.3.8.1.5	IldpLocManAddrIfId	R	INT32
1.0.8802.1.1.2.1.3.8.1.6	IldpLocManAddrOID	R	OID
1.0.8802.1.1.2.1.4	IldpRemoteSystemsData	N	
1.0.8802.1.1.2.1.4.1	IldpRemTable	N	
1.0.8802.1.1.2.1.4.1.1	IldpRemEntry	N	
1.0.8802.1.1.2.1.4.1.1.1	IldpRemTimeMark	N	TimeTicks
1.0.8802.1.1.2.1.4.1.1.2	IldpRemLocalPortNum	N	INT32
1.0.8802.1.1.2.1.4.1.1.3	IldpRemIndex	N	INT32
1.0.8802.1.1.2.1.4.1.1.4	IldpRemChassisIdSubtype	R	INT
1.0.8802.1.1.2.1.4.1.1.5	IldpRemChassisId	R	OS[255]
1.0.8802.1.1.2.1.4.1.1.6	IldpRemPortIdSubtype	R	INT
1.0.8802.1.1.2.1.4.1.1.7	IldpRemPortId	R	OS[255]
1.0.8802.1.1.2.1.4.1.1.8	IldpRemPortDesc	R	OS[255]
1.0.8802.1.1.2.1.4.1.1.9	IldpRemSysName	R	OS[255]
1.0.8802.1.1.2.1.4.1.1.10	IldpRemSysDesc	R	OS[255]
1.0.8802.1.1.2.1.4.1.1.11	IldpRemSysCapSupported	R	OS[1]
1.0.8802.1.1.2.1.4.1.1.12	IldpRemSysCapEnabled	R	OS[1]
1.0.8802.1.1.2.1.4.2	IldpRemManAddrTable	N	
1.0.8802.1.1.2.1.4.2.1	IldpRemManAddrEntry	N	
1.0.8802.1.1.2.1.4.2.1.1	IldpRemManAddrSubtype	N	INT
1.0.8802.1.1.2.1.4.2.1.2	IldpRemManAddr	N	OS[31]
1.0.8802.1.1.2.1.4.2.1.3	IldpRemManAddrIfSubtype	R	INT
1.0.8802.1.1.2.1.4.2.1.4	IldpRemManAddrIfId	R	INT32
1.0.8802.1.1.2.1.4.2.1.5	IldpRemManAddrOID	R	OID

8.5.3 LLDP-EXT-PNIO-MIB

OID	Object name	Access	Type
1.0.8802.1.1.2.1.5	IldpExtensions	N	

OID	Object name	Access	Type
1.0.8802.1.1.2.1.5.3791	IldpXPnoMIB	N	
1.0.8802.1.1.2.1.5.3791.1	IldpXPnoObjects	N	
1.0.8802.1.1.2.1.5.3791.1.2	IldpXPnoLocalData		
1.0.8802.1.1.2.1.5.3791.1.2.1	IldpXPnoLocTable	N	
1.0.8802.1.1.2.1.5.3791.1.2.1.1	IldpXPnoLocEntry	N	
1.0.8802.1.1.2.1.5.3791.1.2.1.1.1	IldpXPnoLocLPDValue	R	UINT32
1.0.8802.1.1.2.1.5.3791.1.2.1.1.2	IldpXPnoLocPortTxDValue	R	UINT32
1.0.8802.1.1.2.1.5.3791.1.2.1.1.3	IldpXPnoLocPortRxDValue	R	UINT32
1.0.8802.1.1.2.1.5.3791.1.2.1.1.6	IldpXPnoLocPortNoS	R	OS[255]
1.0.8802.1.1.2.1.5.3791.1.3	IldpXPnoRemoteData		
1.0.8802.1.1.2.1.5.3791.1.3.1	IldpXPnoRemTable	N	
1.0.8802.1.1.2.1.5.3791.1.3.1.1	IldpXPnoRemEntry	N	
1.0.8802.1.1.2.1.5.3791.1.3.1.1.1	IldpXPnoRemLPDValue	R	UINT32
1.0.8802.1.1.2.1.5.3791.1.3.1.1.2	IldpXPnoRemPortTxDValue	R	UINT32
1.0.8802.1.1.2.1.5.3791.1.3.1.1.3	IldpXPnoRemPortRxDValue	R	UINT32
1.0.8802.1.1.2.1.5.3791.1.3.1.1.6	IldpXPnoRemPortNoS	R	OS[255]

8.5.4 LLDP-EXT-DOT3-MIB

OID	Object name	Access	Type
1.0.8802.1.1.2.1.5.4623	IldpXdot3MIB	N	
1.0.8802.1.1.2.1.5.4623.1	IldpXdot3Objects	N	
1.0.8802.1.1.2.1.5.4623.1.2	IldpXdot3LocalData		
1.0.8802.1.1.2.1.5.4623.1.2.1	IldpXdot3LocPortTable	N	
1.0.8802.1.1.2.1.5.4623.1.2.1.1	IldpXdot3LocPortEntry	N	
1.0.8802.1.1.2.1.5.4623.1.2.1.1.1	IldpXdot3LocPortAutoNegSupported	R	INT
1.0.8802.1.1.2.1.5.4623.1.2.1.1.2	IldpXdot3LocPortAutoNegEnabled	R	INT
1.0.8802.1.1.2.1.5.4623.1.2.1.1.3	IldpXdot3LocPortAutoNegAdvertisedCap	R	OS[2]
1.0.8802.1.1.2.1.5.4623.1.2.1.1.4	IldpXdot3LocPortOperMauType	R	INT32
1.0.8802.1.1.2.1.5.4623.1.3	IldpXdot3RemoteData	N	
1.0.8802.1.1.2.1.5.4623.1.3.1	IldpXdot3RemPortTable	N	
1.0.8802.1.1.2.1.5.4623.1.3.1.1	IldpXdot3RemPortEntry	N	
1.0.8802.1.1.2.1.5.4623.1.3.1.1.1	IldpXdot3RemPortAutoNegSupported	R	INT
1.0.8802.1.1.2.1.5.4623.1.3.1.1.2	IldpXdot3RemPortAutoNegEnabled	R	INT
1.0.8802.1.1.2.1.5.4623.1.3.1.1.3	IldpXdot3RemPortAutoNegAdvertisedCap	R	OS[2]
1.0.8802.1.1.2.1.5.4623.1.3.1.1.4	IldpXdot3RemPortOperMauType	R	INT32

8.6 PROFIdrive

Specifications for PROFIdrive of WJ-PN are the following.

Item	Specification
Version	4.2
Application class	AC1 (Standard Drive)
Telegram	Standard telegram 1 WJ-PN telegram 103 (same as PPO3 of PROFIdrive version 2) WJ-PN telegram 104 (same as PPO4 of PROFIdrive version 2) WJ-PN telegram 105 (like PPO5 of PROFIdrive version 2)
Configuring of telegram	From P160 to P179 of WJ200 / WL200 parameters
Operating mode	Speed control mode
Jogging	Only jogging 1 is supported.

The size of send and receive data of each telegram are the following.

WJ-PN telegrams are the device specific telegrams and compatible with PPOs of PROFIdrive version 2. However, WJ-PN telegram doesn't have PKW (parameter area) and has only PZD (process data area).

Telegram	Setpoint (from PROFINET IO controller to WJ-PN)	Actual value (from WJ-PN to PROFINET IO controller)
Standard telegram 1	2 word	2 word
WJ-PN telegram 103 (same as PPO3 of PROFIdrive version 2)	2 word	2 word
WJ-PN telegram 104 (same as PPO4 of PROFIdrive version 2)	6 word	6 word
WJ-PN telegram 105 (like PPO5 of PROFIdrive version 2)	10 word	10 word

Please refer to “8.12 Telegram” for details of each telegram.

8.7 State machine on PROFdrive

8.7.1 State diagram

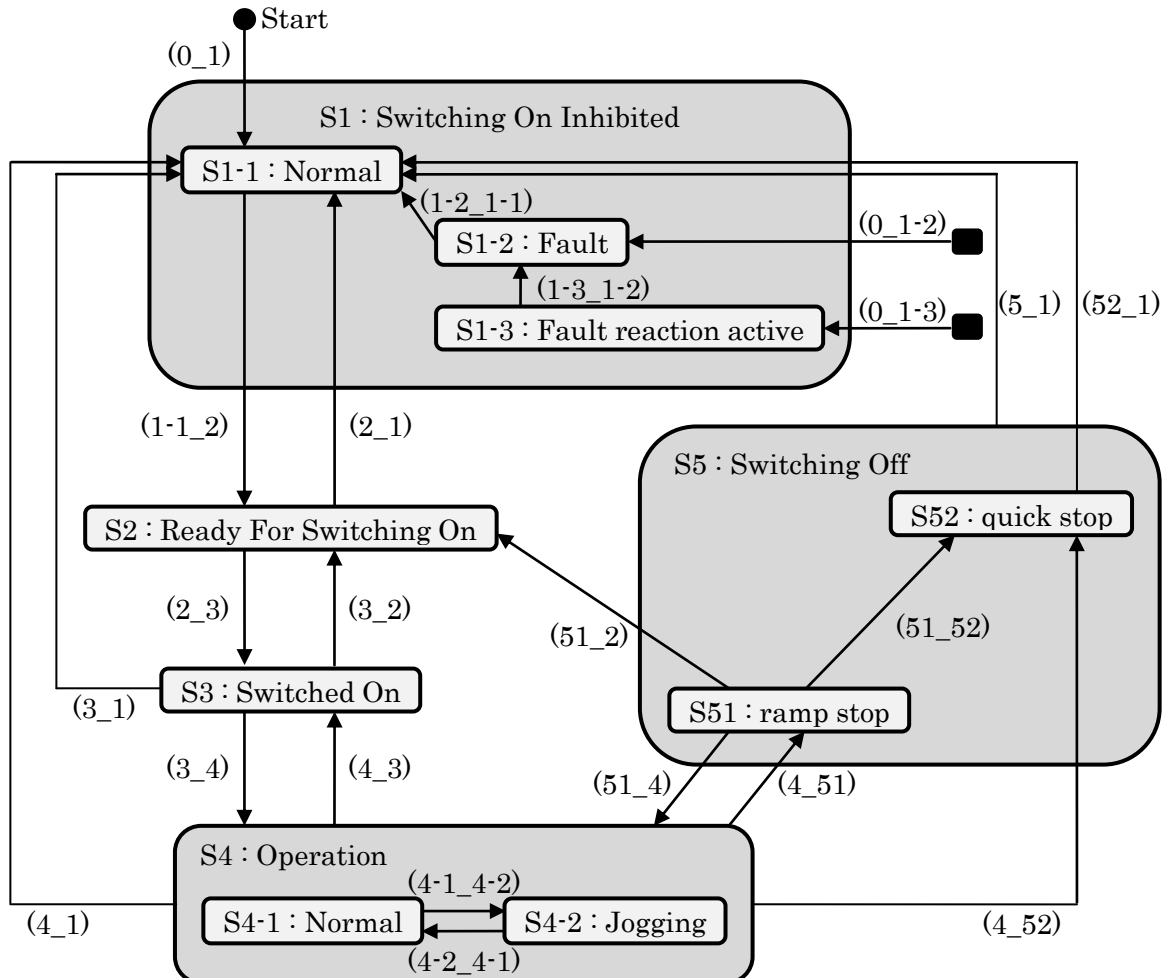

Note : The black rounded rectangles means every states.

Each transition is the following. Upper transition is given priority.

Transition source	Transition	Condition
From initial state	(0_1)	Power on, or reset.
In case of error.	(0_1-3)	When WJ200 / WL200 is on the operation and either of the following conditions are satisfied. - The communication error is occurred between WJ-PN and WJ200 / WL200. - The communication timeout error that it has been the time of P044 since previous communication occurs on PROFINET and P045 = 1.
	(0_1-2)	When except the above error occurs.
From S1-1	(1-1_2)	When all of the following conditions of STW1 are satisfied. Bit0 = OFF, Bit1 = ON, Bit2 = ON
From S1-2	(1-2_1-1)	When STW1 Bit7 becomes from OFF to ON and keeps ON for at least 20ms.

Transition source	Transition	Condition
From S1-3	(1-3_1-2)	The output frequency of WJ200 / WL200 is 0 [Hz].
From S2	(2_1)	When either of the following conditions of STW1 is satisfied. Bit1 = OFF, Bit2 = OFF
	(2_3)	STW1 Bit0 = ON
From S3	(3_1)	When either of the following conditions of STW1 is satisfied. Bit1 = OFF, Bit2 = OFF
	(3_2)	STW1 Bit0 = OFF
	(3_4)	STW1 Bit3 = ON
From S4	(4_1)	STW1 Bit1 = OFF
	(4_52)	When either of the following conditions are satisfied. - STW1 Bit 2 = OFF. - STW1 Bit 0 = ON and Bit 4 = OFF.
	(4_51)	STW1 Bit0 = OFF
	(4_3)	STW1 Bit3 = OFF
From S4-1	(4-1_4-2)	When all of the following conditions are satisfied. - The output frequency of WJ200 / WL200 is 0 [Hz]. - All of STW1 Bit 4- 6 are OFF. - STW1 Bit 8 is ON
From S4-2	(4-2_4-1)	When all of the following conditions are satisfied. - The output frequency of WJ200 / WL200 is 0 [Hz]. - Either of STW1 Bit 4- 6 is ON. - STW1 Bit 8 is OFF
From S5	(5_1)	STW1 Bit1 = OFF
From S51	(51_52)	STW1 Bit2 = OFF
	(51_2)	When either of the following conditions are satisfied. - The output frequency of WJ200 / WL200 is 0 [Hz]. - STW1 Bit 3 = OFF.
	(51_4)	STW1 Bit0 = ON
From S52	(52_1)	When either of the following conditions are satisfied. - The output frequency of WJ200 / WL200 is 0 [Hz]. - STW1 Bit 3 = OFF.

8.7.2 Description each state

State		Description
S1	Switching On Inhibited	Inverter is stopping.
S1-1	Normal	No Error occurs in inverter.
S1-2	Fault	An error occurs and the error is not cleared.
S1-3	Fault reaction active	WJ-PN detects an error, and inverter is during deceleration. When inverter stops, WJ-PN makes inverter trip and changes the state to S1-2.
S2	Ready For Switching On	Inverter is stopping.
S3	Switched On	Inverter is stopping.
S4	Operation	Inverter can be operated.
S4-1	Normal	Inverter is running normally.

S4-2	Jogging	Inverter is running by jogging.
S5	Switching Off	Inverter is decelerating.
S51	ramp stop	Inverter is decelerating by ramp stop.
S52	quick stop	Inverter is decelerating by quick stop (2ch function of WJ200 / WL200).

The state S*-* aren't defined at the figure of General State Diagram in the PROFIdrive specification.

8.8 STW1 (Control word)

The size of STW1 is 16 bits.

The specification of each bit is the following.

Bit	Value	Significance	Description
0	1	ON	When the state is in “Ready For Switching On” , the state is changed to “Switched On” . When the state is in “ramp stop” , the state is changed to “Operation” .
	0	OFF (OFF 1)	When the state is in “Switched On” , the state is changed to “Ready For Switching On” . When the state is in “Operation” , the state is changed to “ramp stop” and inverter decelerates by ramp stop.
1	1	No Coast Stop (no OFF 2)	When the state is in “Switching On Inhibited” and STW1 bit2 is ON, the state is changed to “Ready For Switching On” .
	0	Coast Stop (OFF 2)	When the state is in “Ready For Switching On” or “Switched On” , the state is changed to “Switching On Inhibited” . When the state is in “Operation” or “Switching Off (ramp stop or quick stop)” , the state is changed to “Switching On Inhibited” and inverter stops by coast stop.
2	1	No Quick Stop (no OFF 3)	When the state is in “Switching On Inhibited” and STW1 bit1 is ON, the state is changed to “Ready For Switching On” .
	0	Quick Stop (OFF 3)	When the state is in “Ready For Switching On” or “Switched On” , the state is changed to “Switching On Inhibited” . When the state is in “Operation” or “ramp stop” , the state is changed to “quick stop” and inverter decelerates by 2ch function of WJ200 / WL200. If C005 isn’ t 2ch, inverter decelerates by ramp stop.
3	1	Enable Operation	When the state is in “Switched On” , the state is changed to “Operation” .
	0	Disable Operation	When the state is in “ramp stop” , the state is changed to “Ready For Switching On” . When the state is in “quick stop” , the state is changed to “Switching On Inhibited” .
4	1	Enable Ramp Generator	The output frequency is set Speed Setpoint A (NSOLL_A) and inverter accelerates.
	0	Reset Ramp Generator	The output frequency is set 0 and inverter runs by 0 [Hz]. When inverter is running and both this bit and bit 0 are changed from 1 to 0, inverter decelerates and stops by 2CH function of WJ200 / WL200.

Bit	Value	Significance	Description
5	1	Unfreeze Ramp Generator	The current output frequency isn't held. Inverter runs by the output frequency.
	0	Freeze Ramp Generator	When C006 is HLD, the current output frequency is held.
6	1	Enable Setpoint	The output frequency is set Speed Setpoint A (NSOLL_A).
	0	Disable Setpoint	The output frequency is set 0.
7	1	Fault Acknowledge (0 -> 1)	When this bit is changed from 0 to 1, errors are cleared.
	0	No significance	Do nothing.
8	1	Jog 1 ON	When the state is "Operation", the output frequency is 0 and bit4 - 6 are 0, inverter runs by jogging.
	0	Jog 1 OFF	When inverter runs by jogging, Inverter stops.
9	1	Jog 2 ON	Not supported
	0	Jog 2 OFF	
10	1	Control By PLC	Inverter can be controlled by PLC.
	0	No Control By PLC	Inverter can't be controlled by PLC.
11	1	Reverse	Inverter runs in reverse direction.
	0	Forward	Inverter runs in forward direction.
12 - 15			Unsupported

Bit 11 is device specific.

8.9 ZSW1 (Status word)

The size of ZSW1 is 16 bits.

The specification of each bit is the following.

Bit	Value	Significance	Description
0	1	Ready To Switch On	When the state isn't "Switching On Inhibited", this bit is ON.
	0	Not Ready To Switch On	When the state is "Switching On Inhibited", this bit is OFF.
1	1	Ready To Operate	When the state is "Switched On", "Operation" or "Switching Off (ramp stop or quick stop)", this bit is ON.
	0	Not Ready To Operate	When the state is "Switching On Inhibited" or "Ready For Switching On", this bit is OFF.
2	1	Operation Enabled	When the state is "Operation", this bit is ON.
	0	Operation Disabled	When the state isn't "Operation", this bit is OFF.
3	1	Fault Present	When error occurs in inverter or WJ-PN, this bit is ON.
	0	No Fault	No error occurs in inverter or WJ-PN.
4	1	Coast Stop Not Activated (No OFF 2)	When STW1 bit1 is ON, this bit is ON.

Chapter 8 PROFINET Specification

Bit	Value	Significance	Description
	0	Coast Stop Activated (OFF 2)	When STW1 bit1 is OFF, this bit is OFF.
5	1	Quick Stop Not Activated	When STW2 bit1 is ON, this bit is ON.
	0	Quick Stop Activated (OFF 3)	When STW2 bit1 is OFF, this bit is OFF.
6	1	Switching On Inhibited	When the state is “Switching On Inhibited” , this bit is ON.
	0	Switching On Not Inhibit	When the state isn’ t “Switching On Inhibited” , this bit is OFF.
7	1	Warning Present	When warning occurs in inverter or WJ-PN, this bit is ON.
	0	No Warning	No warning occurs in inverter or WJ-PN.
8	1	Speed Error Within Tolerance Range	When the output frequency reaches the set frequency, this bit is ON.
	0	Speed Error Out Of Tolerance Range	When the output frequency doesn’ t reach the set frequency, this bit is OFF.
9	1	Control Requested	WJ-PN can accept data that is communicated by PROFINET.
	0	No Control Requested	WJ-PN can’ t accept data that is communicated by PROFINET.
10	1	f Or n Reached Or Exceeded	When the output frequency reaches or exceeds the set frequency, this bit is ON. This bit is same as FA2 of WJ200 / WL200. You need to set C042 and C043.
	0	f Or n Not Reached	When the output frequency doesn’ t reach and exceed the set frequency, this bit is OFF. This bit is same as FA2 of WJ200 / WL200. You need to set C042 and C043.
11 - 15			Reserved

8.10 NSOLL_A / NIST_A

NSOLL_A is Speed setpoint A, means the setting of output frequency. Inverter runs this setting at not jogging but normal operation. When inverter runs at jogging, inverter runs not NSOLL_A but A038 of WJ200 / WL200 parameter.

NIST_A is Speed actual value A, means the actual output frequency. This value means the actual output frequency at both normal and jogging operations.

The size of these is signed 16 bits data. The sign means direction of rotation. The positive value means forward, the negative value means reverse. However, the actual direction of rotation depends on both the sign of NSOLL_A and STW1 bit11.

NSOLL_A \ STW1 bit11	ON	OFF
	Positive	Reverse
Negative	Forward	Reverse

The data type of these is N2. The value of N2 means the following.

Value	Significance
-32768 (0x8000)	-200 %
-32767 ~ -1 (0x8001 ~ 0xFFFF)	-199.993896484375 % ~ -0.0061 %
-16384 (0xC000)	-100 %
0 (0x0)	0 %
16384 (0x4000)	100 %
1 ~ 32766 (0x1 ~ 0x7FFE)	0.0061 % ~ 199.98779296875 %
32767 (0x7FFF)	199.993896484375 %

The base frequency of these is set A004 of WJ200 / WL200 parameter.

[Example]

When A004 = 60.0 [Hz] and NSOLL_A = 8192 (0x2000 : 50%), inverter runs 30.0 [Hz].
When the absolute value of NSOLL_A is over 100%, inverter runs 100%.

NIST_A always depends on A004 even if inverter runs at jogging operation. Therefore, when the output frequency reaches the jogging frequency (A038), NIST_A doesn't equal NSOLL_A. However, STW1 Bit8 becomes ON.

[Example]

When A004 = 60.0 [Hz], A038 = 6.00 [Hz] and NSOLL_A = 16384 (0x4000 : 100%), inverter runs 6.0 [Hz] By jogging and NIST_A becomes 1638 (0x666 : 10%).

8.11 Telegram

8.11.1 Standard telegram 1

Setpoint and actual value of Standard telegram 1 are the Following.

I/O Data No	Setpoint (from PROFINET IO controller to WJ-PN)	Actual value (from WJ-PN to PROFINET IO controller)
1	STW1	ZSW1
2	NSOLL_A	NIST_A

8.11.2 WJ-PN telegram 103 to 105

Setpoint and Actual value of WJ-PN telegram 103 - 105 are the following. Send and receive data are the data that you set P160 - 179.

I/O Data No	Setpoint (from PROFINET IO controller to WJ-PN)	Actual value (from WJ-PN to PROFINET IO controller)	WJ-PN telegram		
			103	104	105
1	P160	P170	✓	✓	✓
2	P161	P171	✓	✓	✓
3	P162	P172		✓	✓
4	P163	P173		✓	✓
5	P164	P174		✓	✓
6	P165	P175		✓	✓
7	P166	P176			✓
8	P167	P177			✓
9	P168	P178			✓
10	P169	P179			✓

You need to set P160 - P179 to 0 or Modbus register No. of WJ200 / WL200. If you don't use P162 - P169 and P172 - P179, you need to set these to 0.

When you set P160 to 0, setpoint data is STW1.

When you set P161 to 0, setpoint data is NSOLL_A.

When you set P170 to 0, setpoint data is ZSW1.

When you set P171 to 0, setpoint data is NIST_A.

When you want to set 32bit length data to P160 - P179, you need to set consecutively. If you don't set consecutively, PNU 954 bit 4 becomes ON.

The byte order of 32bit length data depends on the setting of P160 - P179. For example, the Modbus register No. 0x1001 is the high byte and 0x1002 is the low byte. When you want to set d001 to P171 and P172, you need to set either the followings.

- P171 = 0x1001, P172 = 0x1002

In this case, the high byte is sent first.

- P171 = 0x1002, P172 = 0x1001

In this case, the low byte is sent first.

When you set P160 - P161 to the value that are non-existent Modbus register No. and P162 - P169 to 0 or the value that are non-existent Modbus register No., WJ-PN receives data from PROFINET IO controller, but WJ-PN doesn't set to WJ200 / WL200. When you set P160 - P169 non-existent Modbus register No., PNU 954 bit 3 becomes ON.

When you set P170 - P171 to the value that are non-existent Modbus register No. and P172 - P179 to 0 or the value that are non-existent Modbus register No., WJ-PN doesn't read data from WJ200 / WL200 and always sends 0 to PROFINET IO controller. When you set P170 - P179 non-existent Modbus register No., PNU 954 bit 3 becomes ON.

Hints

Please don't assign setpoint to F001 (Modbus register No. 0x0001, 0x0002). If you want to assign setpoint to the output frequency, you can assign it a way either of the followings.

(1) You set P161 to 0 (NSOLL_A) (The unit is % of A004)

(2) You set P160 - P169 to 0x1F14 of Modbus register No. (The unit is 0.01[Hz])

If you set P160 - P169 to F001 (Modbus register No. 0x0001, 0x0002), WJ-PN detects the warning that PNU954 bit5 is ON and F001 of WJ200 / WL200 isn't refreshed by the communication data. If you set P160 - P169 to the output frequency by both above (1) and (2), WJ-PN detects the warning that PNU954 bit6 is ON and F001 of WJ200 / WL200 isn't reflected by the communication data.

8.12 Parameter access

You can access the parameter by Record Data CR. When you access the parameter, you need to set 0xB02E to index.

8.12.1 write data record and read data record

First you need to send a request of parameter read or write to WJ-PN by write data record (e.g. WRREC) from PROFINET IO controller or supervisor.

Next you need to send a request to read the response to WJ-PN by read data record (e.g. RDREC) from PROFINET IO controller or supervisor. If there is an error, the reply to a Read or Write service is an error response.

Please refer to the PROFIdrive specification or a manual of PROFINET IO controller or supervisor that you use.

8.12.2 Parameter access on PROFIdrive

The request data frame to parameter access on PROFIdrive is the following.

Word offset	Block	Byte n	Byte n+1
0	Request header	Request reference	Request ID
1		Axis-No. / DO-ID	The number of parameters = i
2	1st Parameter address	Attribute	The number of elements
3		PNU	
4		Subindex	
- 3i + 1	ith Parameter address	...	
3i + 2	1st Parameter value	Format	The number of values
3i + 3		Value	
		...	
	ith Parameter value	...	

The Parameter values need to be set only for request “Change parameter”. These don't need to be set for request “Request parameter”.

The response data frame to parameter access on PROFIdrive is the following.

Word offset	Block	Byte n	Byte n+1
0	Response header	Request reference = (*)	Request ID
1		Axis-No. / DO-ID = (*)	The number of parameters = i
2	1st Parameter value	Format	The number of values
3		Value or error code	
		...	
	ith Parameter value	...	

(*)These are same as the request.

The Parameter values exist only for request “Request parameter”.

The descriptions of data are the following.

Block	Field	Data type	Description
Request Header	Request Reference	Unsigned8	The message ID. Unique ID of the request / response pair for the PROFINET IO controller. Reserved : 0x00 ID : 0x01 - 0xFF
	Request ID	Unsigned8	The type of request data. Request parameter : 0x01 Change parameter : 0x02

Block	Field	Data type	Description
	Response ID	Unsigned8	The type of response data. Request parameter (+) : 0x01 Request parameter (-) : 0x81 Change parameter (+) : 0x02 Change parameter (-) : 0x82 Unsupported service : 0x80
	Axis-No. / DO-ID	Unsigned8	Axis-No. / DO-ID that you access. You need to set 0x00 or 0x01 in WJ-PN.
	No. of Parameters	Unsigned8	The number of parameters. You can set from 1 to 39 in PROFINET.
Parameter Address	Attribute	Unsigned8	The type of parameter that you access. Value : 0x10 Description : 0x20 Text : 0x30
	Number of Elements	Unsigned8	When the parameter that you access is Array or String, this parameter means the number of elements. You can set from 1 to 234. When the parameter that you access is the other, you need to set 0.
	Parameter Number	Unsigned16	Parameter number Reserved : 0x0000 Parameter number : 0x0001 - 0xFFFF
	Subindex	Unsigned16	The subindex of parameter : 0x0000 - 0xFFFE
Parameter Value	Format	Unsigned8	The data type of values. Unsigned16 : 0x06 Unsigned32 : 0x07 Octet string : 0x0A V2 (*) : 0x73 Zero : 0x40 (The response value doesn't exist.) Byte : 0x41 Word : 0x42 Double word : 0x43 Error : 0x44
	Number of Values	Unsigned8	The number of values. This value is from 0 to 234.
	Values	Depend on data	The value that you read or change.
	Error value 1	Unsigned16	Error code : 0x0000 - 0x00FF (The lower byte is the error code.)
	Error value 2	Unsigned16	It depends on an error value 1 whether this data exist. This value shows the subindex of the first array element where the error occurs.

(*) V2 is boolean variables are combined in two octets. Refer to the specification of PROFIdrive for detail.

The error codes are the following.

Error No. = Error value1	Meaning	Used at	Additional info = Error value 2
0x00	Impermissible parameter number	Access to unavailable parameter	0
0x01	Parameter value cannot be changed	Change access to a parameter value that cannot be changed	Subindex
0x02	Low or high limit exceeded	Change access with value outside the value limits	Subindex
0x03	Faulty subindex	Access to unavailable subindex of array or string parameter. Shall not be used for single parameters	Subindex
0x04	No array	Access with subindex to non-indexed Parameter	0
0x05	Incorrect data type	Change access with value that does not match the data type of the parameter	0
0x06	Setting not permitted (may only be reset)	Change access with value unequal to 0 where this is not permitted	Subindex
0x07	Description element cannot be Changed	Change access to a description element that cannot be changed	Subindex
0x09	No description data available	Access to unavailable description (parameter value is available)	0
0x0B	No operation priority	Change access without rights to change Parameters	0
0x0F	No text array available	Access to text array that is not available (parameter value is available)	0
0x11	Request cannot be executed because of operating state	Access is temporarily not possible for reasons that are not specified in detail. When the parameter of WJ200 / WL200 is accessed, please check whether the inverter can accept change access.	0
0x14	Value impermissible	Change access with a value that is within the value limits, but is not permissible for other long-term reasons (parameter with defined single values)	Subindex
0x15	Response too long	The length of the current response exceeds the maximum transmittable length of the response transport block. In case of a multi parameter request, the response block was shortened by omitting of parameter requests.	0

Chapter 8 PROFINET Specification

Error No. = Error value1	Meaning	Used at	Additional info = Error value 2
0x16	Parameter address impermissible	Illegal value (reserved) or value which is not supported for the attribute, illegal or not supported number of elements, illegal parameter number or illegal subindex or a combination	0
0x17	Illegal format	Write request: Illegal format or format of the parameter data which is not supported	0
0x18	Number of values are not consistent	Write request: Number of the values of the parameter data do not match the number of elements in the parameter address	0
0x19	Axis/DO nonexistent	Access to an Axis/DO which does not exist	0
0x20	Parameter text element cannot be Changed	Change access to a parameter text element that cannot be changed	Subindex
0x21	Service not supported	Illegal or unknown Request ID (Response ID = 0x80)	-
0x22	Too much parameter requests	Multi parameter request: The response block does not contain all parameter responses because of maximum number of supported parameter requests per multi parameter request was exceeded.	-
0x23	Multi parameter access not Supported	Device parameter manager does not support multi parameter requests. Request is discarded.	-
0x65 0x67	Error of access to WJ200 / WL200 (Manufacturer-specific)	It is an error of access to WJ200 / WL200. You access while WJ200 / WL200 is initializing or changing the mode. If WJ-PN returns these values while WJ200 / WL200 isn' t initializing or changing the mode, please contact the nearest business contact.	-
0x66	The accessed parameter doesn' t exist at WL200. (Manufacturer-specific)	You access the parameter that doesn' t exist at WL200.	-

You can access multi parameters at a request message. However, when an error occurs, there are cases that the process is stopped and returns the response. This depends on kind of errors. You need to resolve/investigate what process has been done by checking the returned message, because WJ-PN will stop the internal transaction immediately and return the message when the requested command/address was wrong.

For example, when you set the wrong data type like the following request, the process is stopped

and returns the response. The following values are hexadecimal.

[The request] (*) The underline part is the wrong data.

01 02 01 03 10 01 03 FA 00 29 10 01 07 E2 00 74 10 01 07 E2 00 76 06 01 02 58 06 01 00 00
00 00 07 01 00 00 00 00

[The response] (*) The underline parts show error.

01 82 01 02 40 00 44 01 00 05

8.13 PNU (parameter number)

The parameter number is assigned to each parameter. The number range of the parameters is specified for 0 - 65535. The details are the following.

PNU	Area	Description
0 - 899	Device specific	Unused
900 - 999	For PROFIdrive	Parameters for PROFIdrive
1000 - 59999	Device specific (Inverter parameter area)	These are parameters to access the parameters of WJ200 / WL200 in WJ-PN.
60000 - 60999	Reserved for PROFIdrive	Unused
61000 - 63999	Reserved for PROFIdrive (PROFINET I/O)	Parameters for PROFINET
64000 - 65535	Reserved for PROFIdrive	Unused

8.13.1 Data types

The data types shown in the following table are used in this profile.

Data types	Code	Size	Range
Unsigned16	UINT	2 bytes	0 to 65,535
Unsigned32	UDINT	4 bytes	0 to 4,294,967,295
V2	V2	2 bytes	0x0000 to 0xFFFF
Octet string	STR	-	-
Array	ARRAY	-	-

8.13.2 Access

The access methods shown in the following table are used in this profile. It indicates whether the object is read or write only, or read and write.

Access	Description
R	Read only.
W	Write only.
RW	Read and write.

8.13.3 PROFIdrive area

● 915

Sub-Index	Item	Description
	Name	Selection switch for DO IO Data in the setpoint telegram
	Data type	ARRAY of UINT
	Access	R
	Default setting	0
	Detail	This area displays P160 - P169 of WJ200 / WL200.
0x00	Detail	0x0000 : STW1 The others : Modbus register No. of WJ200 / WL200
0x01	Detail	0x0000 : NSOLL_A The others : Modbus register No. of WJ200 / WL200
0x02 - 0x09	Detail	0x0000 : Unused The others : Modbus register No. of WJ200 / WL200

● 916

Sub-Index	Item	Description
	Name	Selection switch for DO IO Data in the actual value telegram
	Data type	ARRAY of UINT
	Access	R
	Default setting	0
	Detail	This area displays P170 - P179 of WJ200 / WL200.
0x00	Detail	0x0000 : ZSW1 The others : Modbus register No. of WJ200 / WL200
0x01	Detail	0x0000 : NIST_A The others : Modbus register No. of WJ200 / WL200
0x02 - 0x09	Detail	0x0000 : Unused The others : Modbus register No. of WJ200 / WL200

● 922

Sub-Index	Item	Description
-	Name	Telegram selection
-	Data type	UINT
-	Access	R
-	Default setting	1
-	Detail	This area displays telegram number that WJ-PN is communicating. 1 : Standard telegram 1 103 : WJ-PN telegram 103 104 : WJ-PN telegram 104 105 : WJ-PN telegram 105

● 944

Sub-Index	Item	Description
-	Name	Fault message counter
	Data type	UINT
	Access	R
	Default setting	0
	Detail	This area displays the number of times that the fault buffer has been changed. When the fault buffer is changed, this value is increased by 1. When you write PNU952 0, the fault buffer is cleared and this value becomes 0.

● 947

Sub-Index	Item	Description
0x00	Name	Fault number
-	Data type	ARRAY of UINT
0x3F	Access	R
	Default setting	1
	Detail	This area displays the fault number list that occurred in WJ200 / WL200 and WJ-PN.

● 952

Sub-Index	Item	Description
-	Name	Fault situation counter
	Data type	UINT
	Access	RW
	Default setting	0
	Detail	This area displays the number of fault situation since power on or the last reset. Fault situation isn't the number of times that error occurred but the number of times that you have acknowledged errors. You can acknowledge some errors. Therefore, this value differs from the number of times that error occurred. [Write] This parameter can be written only 0. When you write this PNU 0, PNU944, PNU952 and PNU947 are cleared.

● 953

Sub-Index	Item	Description
-	Name	Warning parameters
	Data type	V2
	Access	R
	Default setting	0
	Detail	This area displays the warning of WJ200 / WL200. This parameter is same as d090 of WJ200 / WL200.

● 954

Sub-Index	Item	Description
-	Name	Warning parameters
	Data type	V2
	Access	R
	Default setting	0
	Detail	This area displays the warning of WJ-PN. Please refer to “8.16 Warning” for details.

● 964

Sub-Index	Item	Description
	Name	Drive Unit identification
	Data type	ARRAY of UINT
	Access	R
	Detail	This area displays the information of WJ-PN.
0x00	Name	Manufacturer
	Default setting	617
	Detail	This area displays the vendor code.
0x01	Name	Drive Unit type
	Default setting	0x0301
	Detail	This area displays drive unit type code that is the device ID of WJ-PN
0x02	Name	Version (Software)
	Default setting	This value depends on shipment time.
	Detail	This area displays software version of WJ-PN. When version is xx.yy, this parameter is xxyy (decimal).
0x03	Name	Firmware date (year)
	Default setting	This value depends on shipment time.
	Detail	This area displays year (decimal) that firmware of WJ-PN was created.
0x04	Name	Firmware date (day/month)
	Default setting	This value depends on shipment time.
	Detail	This area displays day/month (ddmm : decimal) that firmware of WJ-PN was created.

● 965

Sub-Index	Item	Description
-	Name	Telegram selection
	Data type	STR (2 characters)
	Access	R
	Default setting	0x032A
	Detail	This area displays profile number and profile version that WJ-PN supports. The 1st byte means profile number and PROFIdrive is 3. The 2nd byte means profile version. This value is 42, because WJ-PN supports PROFIdrive Ver.4.2. Therefore, this value is 0x032A.

● 61000

Sub-Index	Item	Description
-	Name	NameOfStation
	Data type	STR (240 characters)
	Access	R
	Default setting	-
	Detail	This area displays the NameOfStation of this device.

● 61001

Sub-Index	Item	Description
-	Name	IpOfStation
	Data type	STR (4 characters)
	Access	R
	Default setting	-
	Detail	This area displays the IP address of this device.

● 61002

Sub-Index	Item	Description
-	Name	MacOfStation
	Data type	STR (6 characters)
	Access	R
	Default setting	This value depends on device.
	Detail	This area displays the MAC address of this device.

● 61003

Sub-Index	Item	Description
-	Name	StandardGatewayOfStation
	Data type	STR (4 characters)
	Access	R
	Default setting	-
	Detail	This area displays the default gateway address of this device.

● 61004

Sub-Index	Item	Description
-	Name	SubnetMaskOfStation
	Data type	STR (4 characters)
	Access	R
	Default setting	-
	Detail	This area displays the subnet mask of this device.

8.13.4 PROFIdrive area

Inverter parameters are allocated to objects 1000 to 1037 and 2000 to 2037. 1000 to 1037 are 2-byte parameters and 2000 to 2037 are 4-byte parameters.

Index and sub-index calculation method

Index: $1000 + (\text{Inverter register number} / 254)$, $2000 + (\text{Inverter register number} / 254)$

Sub-Index: $1 + (\text{Inverter register number} \% 254)$,

Where

$(\text{Inverter register number} / 254)$ is the Integer part after the inverter register number is divided by 254.

$(\text{Inverter register number} \% 254)$ is the remainder after the inverter register number is divided by 254.

Please refer to “Appendix object list” for details.

8.14 Fault

When WJ-PN detects a fault, WJ-PN stores the fault code into the fault buffer.

[The sequence to store the fault code into the fault buffer]

- The fault code is stored into PNU 947' s subindex that hasn' t still been stored from 0 to 7. When subindex 0 - 7 have already been stored to, subindex 7 is overwritten.
- PNU 944 is increased by 1.
- ZSW1 bit3 is changed to ON.

[The sequence to acknowledge the fault buffer]

- When STW1 bit 7 is changed from OFF to ON and is ON for 20ms or more, to acknowledge the fault buffer starts.
- The data of subindex 48 - 55 of PNU 947 are copied to subindex 56 - 63.
- The data of subindex 40 - 47 of PNU 947 are copied to subindex 48 - 55.
- The data of subindex 32 - 39 of PNU 947 are copied to subindex 40 - 47.
- The data of subindex 24 - 31 of PNU 947 are copied to subindex 32 - 39.
- The data of subindex 16 - 23 of PNU 947 are copied to subindex 24 - 31.
- The data of subindex 8 - 15 of PNU 947 are copied to subindex 16 - 23.
- The data of subindex 0 - 7 of PNU 947 are copied to subindex 8 - 15.
- 0 is stored into subindex 0 - 7 of PNU 947.
- PNU 952 is increased by 1.
- PNU 944 is increased by 1.
- If trip is occurred in WJ200 / WL200, trip reset is sent to WJ200 / WL200.
- ZSW1 bit3 is changed to OFF.

[The sequence to clear the fault buffer]

- When PNU952 is written 0, to clear the fault buffer starts.
- The data of all subindices of PNU 947 are cleared to 0.
- PNU 944 is changed to 0.

The fault codes are the following.

Fault	Fault code	Description
Trip of WJ200 / WL200	Trip code	Trip was occurred in WJ200 / WL200.
Timeout error of PROFINET	Trip code (63 : E63)	The timeout error was occurred on PROFINET.
The rotary switches error	Trip code (65 : E65)	The rotary switches of WJ-PN couldn' t be read normally.
Communication error between WJ-PN and WJ200 / WL200	0xFF01	Communication error was occurred between WJ-PN and WJ200 / WL200.
The version error of WJ200 / WL200	0xFF02	The version of WJ200 / WL200 that doesn' t support WJ-PN

Please refer to the PROFIdrive specification for details of the fault mechanism.

8.15 Warning

When WJ-PN detects warning, the warning code is stored to PNU 953 and PNU 954, and ZSW1 bit 7 is changed to ON.

The specification of PNU953 is same as d090 of WJ200 / WL200.

The specification that each bit of PNU954 becomes ON is the following.

PNU 954 bit	Conditions
0	C005 ≠ 09 (2CH)
1	C006 ≠ 83 (HLD)
2	Any of C001 - C007 = 06 (JG)
3	The Modbus register No. that doesn't exist is assigned in P160 - P179.
4	The 32bit length Modbus register No. isn't assigned in P160 - P179 consecutively.
5	F001 (The Modbus register No. = 0x0001 (upper), 0x0002 (lower)) is assigned in P160 - P169.
6	There are the settings of the output frequency in P160 - P169. There can be only a setting.
7	P170 = 0 (ZSW1), but P160 ≠ 0 (STW1)
8	The sequence of upper and lower of the 32bit length Modbus register No. differ in selected telegram.

Please refer to Chapter 6 “Troubleshooting and Maintenance” of the WJ200 / WL200 instruction manual for “Warning codes” for the warning about PNU953.

Even if the warning about PNU954 occurs, the inverter can run.

9.1 Status indicator explanations and error handling

The 4 types of indicator lighting statuses are explained in the following table.

Abbreviation	Name and status
On	ON
Off	OFF
Blinking	Blinking ON (200 ms) and OFF (200 ms)
-	Undefined

LINK / ACT 1	LINK / ACT 2	COMM	ERR	Description	Remarks
-	-	On	Off	Communicating by the set telegram	WJ-PN is communicating with PROFINET IO controller by the set telegram.
Off	Off	Off	Off	Power supply error	Power is not being supplied correctly to the Communication Unit. <ul style="list-style-type: none"> • Check that power is being supplied correctly to the inverter (for example, check whether the wiring of the inverter main power supply is correct, if the power supply voltage has dropped, and the inverter is operating normally). • Check that the WJ-PN is mounted correctly onto the inverter. • Eliminate the cause of the error, and then turn the WJ200 / WL200 power supply off and on again.
On	-	Off	-	PROFINET IO controller not available	WJ-PN isn't connected to the PROFINET IO controller unit yet. <ul style="list-style-type: none"> • Check that the PROFINET IO controller unit is operating correctly. • Check that the communications cable is connected correctly to the connector or wired correctly.
-	-	Blinking	Off	Parameter is being set	WJ-PN is being set parameter to from PROFINET IO controller.
-	-	Blinking	-	Flash LED	When you operate Flash LED with an engineering tool, COMM LED is blinking for 3 seconds with a frequency of 1Hz (500ms ON and 500ms OFF).
-	-	Off	Blinking	Error	WJ-PN detects disconnection of PROFINET. <ul style="list-style-type: none"> • Check the power of PROFINET IO controller • Check the cable connecting. • Check the power of devices in the path.
-	-	-	On	Hardware failure	WJ-PN detects hardware failure. Please replace the WJ-PN.

LINK / ACT 1	LINK / ACT 2	COMM	ERR	Description	Remarks
		On	On	During startup	WJ-PN is during startup. WJ-PN can't communicate with PROFINET until WJ-PN has finished startup.

9.2 Inverter errors

When the inverter is in a tripped state, the inverter output turns OFF (trips), and the inverter displays an error code.

The trip history monitor (d081 to d086) also displays the same error code as the inverter.

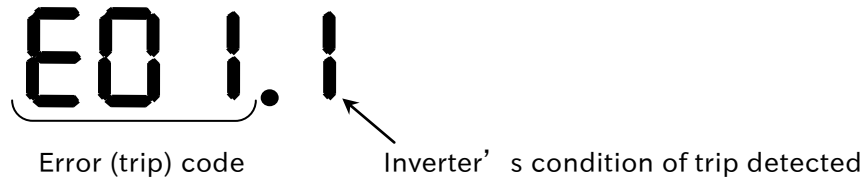

Please refer to Chapter 6 “Troubleshooting and Maintenance” of the WJ200 / WL200 instruction manual for “Error (trip) code” and “Inverter’s condition of trip detected.”

In an inverter tripped state using the WJ-PN, is the following table.

Display and indicators	Possible causes	Remedy
0.00 (Other than trip indication)	The Inverter does not power up	Follow the instructions provided in the WJ200 / WL200 user’s manual to troubleshoot.
	The WJ-PN connector is damaged	Replace the WJ-PN.
	The Inverter RS input is ON	Switch the Inverter RS input OFF.
	Mapping “operator control (31)”, “force terminal mode (51)”, “multi-speed frequency 1 (02)” to the input terminal. At least, the one of them turns ON.	Turn them OFF.
E60.* E69.*	The WJ-PN encountered a fatal error during power up.	Turn it OFF instantly. Then, check that the WJ-PN is mounted properly and restart the WJ-PN. If the problem persists, replace the WJ-PN.
	The WJ-PN connector is damaged	Replace the WJ-PN.
	The WJ-PN is disconnected.	Check that the WJ-PN is connected.
	The WJ-PN encountered a fatal error during Operation.	Check that the WJ-PN is mounted properly and restart the WJ-PN. If the problem persists, replace the WJ-PN.
E63.*	Communication error occurred between the PROFINET IO controller and the WJ-PN.	Check the connection between the PROFINET IO controller and the WJ-PN.

NOTE: E60.* and E69.* are same error contents. E60.* error indicates that are detected in the WJ-PN. E69.* error indicates that are detected in the inverter.

Factor code list

No trip factor	0	Fin temperature error	21
Overcurrent protection during constant speed	1	CPU communication error	22
Overcurrent protection during deceleration	2	Main circuit error	25
Overcurrent protection during acceleration	3	Driver error	30
Overcurrent protection during stop	4	Thermistor error	35
Overload protection	5	Break error addition	36
Braking resistor overload protection	6	Emergency trip	37
Overvoltage protection	7	The low-speed range overload protection	38
EEPROM error	8	Operator bad connection	40
Under voltage protection	9	Easy sequence illegal instruction error	43
Current Transformer error	10	Easy sequence nesting error	44
CPU error	11	Easy sequence execution instruction error	45
External trip	12	Easy sequence user trip 0 to 9	50 to 59
USP error	13	Option error 0 to 9	60 to 69
Grounding protection	14	Encoder disconnection	80
Incoming overvoltage protection	15	Acceleration	81
Temperature detection error	19	Trip position control range	83

Status code list

During reset	0	Operates at frequency = 0	5
During stop	1	During startup	6
During deceleration	2	DB active	7
At a constant speed	3	During overload limit	8
During acceleration	4	-	-

9.3 Hint of the action by the combination with the WJ200 / WL200

The inverter WJ200 / WL200 series has various items (parameters). Attention is necessary because driving movement of the PROFINET changes depending on the items (parameters).

An example is shown below.

9.3.1 A002 (Run command source)

The behavior of WJ200 / WL200 is as follows when changed from OFF (shut off) to ON (enabled to drive) when WJ200 / WL200 is used with Dip-Switch in the position to activate functional safety.

If either GS1 signal or GS2 signal is turned to OFF (shut off), the condition of the output is continued to an interruption state.

It is to be known that approval by a third party for “STO” function is void even if the safety function is activated with the Dip-Switch in the position to select functional safety (STO) when WJ-PN is attached to WJ200 / WL200.

Please refer to [Functional Safety of WJ200 / WL200] in [Chapter 2.1 Outline of product].

Contents	OFF(inverter output is forbidden)→ON(inverter output is allowed)
01 (control circuit terminal block)	Driving restart
02 (digital operator)	stop (driving does not restart)
03 (Modbus)	Driving restart
04 (option)	Driving restart

9.3.2 C102 (reset select)

Select the action of the reset terminal (RS) of the inverter.

By setting of C102, PROFINET communication continuation presence changes by the input of the reset terminal (RS).

The action explanation is as follows.

Contents	Description
00	When the RS is turned ON, the inverter is restored from the trip state, and communication between the inverter and WJ-PN suspends, and PROFINET communication suspends. (In normal state: the inverter output turns OFF In trip state: the inverter is restored from a trip state.)
01	When the RS is turned OFF, the inverter is restored from the trip state, and communication between the inverter and WJ-PN suspends, and PROFINET communication suspends. (In normal state: the inverter output turns OFF In trip state: the inverter is restored from a trip state.)
02	When the RS is turned ON, the inverter is restored from the trip state, and communication between the inverter and WJ-PN suspends, and PROFINET communication suspends. (In normal state: invalid (there is no change to the inverter) In trip state: the inverter is restored from a trip state.)
03	When the RS is turned ON, the inverter is restored from the trip state, the communication between WJ200 / WL200 and WJ-PN continues, the PROFINET communication continues. (In normal state: invalid (there is no change to the inverter) In trip state: the inverter is restored from a trip state.)

9.3.3 Combination with EzSQ

Please be careful of the followings.

- Do not turn ON the logic input 5 (2CH) and the logic input 6 (HLD) with the EzSQ program.
- Do not assign jogging (JG) to the any logic inputs and turn ON its logic input.
- Do not write the parameter both via PROFINET and with EzSQ program at the same time. If you do so, the 1st write access is overwritten by the 2nd write access.

9.3.4 Combination with external 24 V DC power supply

The inverter control section can be powered with external 24V DC power supply. This will allow you to read and write parameters via PROFINET, but please be careful of the followings.

- Do not let inverter run.
- Do not turn off inverter immediately after you store to EEPROM of the inverter. The EEPROM error (E08) may occur in the inverter.

Please refer to the instruction manual of WJ200 / WL200 about externally power 24 V DC.

9.3.5 Control by frequency

You can control the inverter by not NSOLL_A / NIST_A but frequency. When you control the inverter by frequency, you need to set the followings.

- Either Telegram 104 or 105 is used.
- Modbus register No. 0x1F14 is set to any one of P161 - P169.
- Modbus register No. 0x1001 and 0x1002 are set to any of P171 - P179 consecutively.

For example, when you set the following, the output frequency setting is 2nd byte of the message data sent from the PROFINET IO controller to PROFINET IO device and the output frequency monitor is 2nd and 3rd byte of the message data sent from the PROFINET IO device to the PROFINET IO controller.

- Telegram 104
- P161 = 0x1F14
- P171 = 0x1001, P172 = 0x1002

9.4 Hint of WJ-PN and PROFINET

9.4.1 The order of turning on the power of WJ-PN and the PROFINET IO controller

The order of turning on the power of PROFINET IO controllers and PROFINET IO devices isn't defined in PROFINET. When both of a PROFINET IO controller and WJ-PN are turned on the power and both of them are ready to PROFINET, they start to communicate of PROFINET. However, it may take some time that a PROFINET IO controller prepares PROFINET. Please refer to the instruction manual of the PROFINET IO controller for details.

9.4.2 Replacement of WJ-PN and WJ200 / WL200

When you replace WJ-PN and/or WJ200 / WL200, you need to set the device name (NameOfStation) rightly. If you don't set the right device name (NameOfStation), WJ-PN doesn't communicate.

When you replace WJ-PN, you need to set the device name (NameOfStation) the same setting of old WJ-PN with an engineering tool.

When you replace WJ200 / WL200, you need to set the inverter parameters the same setting of old WJ200 / WL200.

When you replace WJ-PN and WJ200 / WL200, you need to set both of them.

If WJ-PN doesn't start to communicate by PROFINET after the replacement, please confirm the PROFINET cable is connected right and turn off and on WJ-PN and WJ200 / WL200.

9.4.3 The initialization and the mode change of WJ200 / WL200

You can initialize and change the mode of WJ200 / WL200 even if WJ-PN is communicating. When you initialize or change the mode while WJ-PN communicates, WJ-PN keeps communicating by PROFINET. However, when you access the inverter parameters while WJ200 / WL200 is initializing, WJ-PN returns the error code 0x65 of PROFIdrive.

You can initialize and change the mode of WJ200 / WL200 via PROFINET.

9.4.4 Network protocol analyzer

You can collect and analyze PROFINET communication log using a network protocol analyzer. It is useful to investigate the unexpected phenomenon.

Recommended analyzers are the following.

Product name	Manufacturer	Type
Wireshark (PC application)	The Wireshark team	-
ET2000	Beckhoff	ET2000

9.4.5 Technical support

To receive technical support for the Hitachi inverter you purchased, please be prepared to provide the following information.

Contents	Note
The phenomenon and frequency	In as much detail as possible.
Type of WJ200 / WL200	Please refer to “1.2.1 Required information for product inquiry” for detail.
MFG No. of WJ-PN and WJ200 / WL200	
Date of purchase WJ-PN and WJ200 / WL200	
The setting of inverter parameters of WJ200 / WL200	The csv file saved with ProDriveNext is desirable.
The PROFINET network layout	Include the node address of all devices.
The PROFINET IO controller that you use	Manufacturer, Type
If there are other PROFINET IO devices, the information of these PROFINET IO devices	If these PROFINET IO devices aren't WJ-PN, Manufacturer, Type of these PROFINET IO devices.
The communication log when the phenomenon occurred.	It is the communication log file saved with the analyzer in “9.4.4 Network protocol analyzer” .

10.1 WJ-PN Specifications

Item		Specification
Installation	Unit type	WJ200 / WL200 Series Option Board ¹
	Model	WJ-PN
	Dimensions (W x H x D)	68 x 60 x 45[mm]
	Weight	170[g] (typical)
Environment	Ambient operating temperature	-10 to 50[degree] (no icing or condensation)
	Ambient operating humidity	20 to 90[%], RH
	Storage temperature	-20 to 65°C (no icing or condensation)
	Vibration resistance	5.9[m/s ²] (0.6[G]) at 10 to 55[Hz]
	Dielectric strength	500[V _{AC}] (between isolated circuits)
	Conformance to EMC and electrical safety standards	EN61800-3: 2004 / A1:2012 (2014/30/EU) First environment, Category C1 ² EN61800-5-1: 2007 (2014/35/EU)
	Enclosure rating	IP 20
PROFINET Interface	Communications protocol	PROFINET IO Ver2.32
	Device type	PROFINET IO Device
	Conformance class	B
	Protocol	DCP, LLDP, SNMP
	Netload	I
	RT / IRT	only RT
	Profile	PROFIdrive
	Physical layer	Auto negotiation (100BASE-TX (IEEE802.3) only)
	port	2 ports
	Connector	RJ45 (Port1 / 2)
	MAC address	3 (Host, Port 1 / 2)
	Cable	100BX-TX supported (category 5e or higher) STP cable (straight or cross allowed)
	Communications distance	Distance between nodes: 100[m] max
PROFIdrive	Version	4.2
	Application class	AC1 (Standard Drive)
	Telegram	Standard telegram 1 WJ-PN telegram 103 (same as PPO3 of PROFIdrive version 2) WJ-PN telegram 104 (same as PPO4 of PROFIdrive version 2) WJ-PN telegram 105 (like PPO5 of PROFIdrive version 2)
	Configuring of telegram	From P160 to P179 of WJ200 / WL200 parameters
	Operating mode	Speed control mode
	Jogging	Only jogging 1 is supported.

Note1: When WJ-PN is attached to WJ200 / WL200, functional safety is not supported. Please refer to “5.3 A system configuration of the PROFINET” for details.

Note2: C1 only when installed in a metal cabinet, otherwise C2.

10.2 Appearance and Dimensions

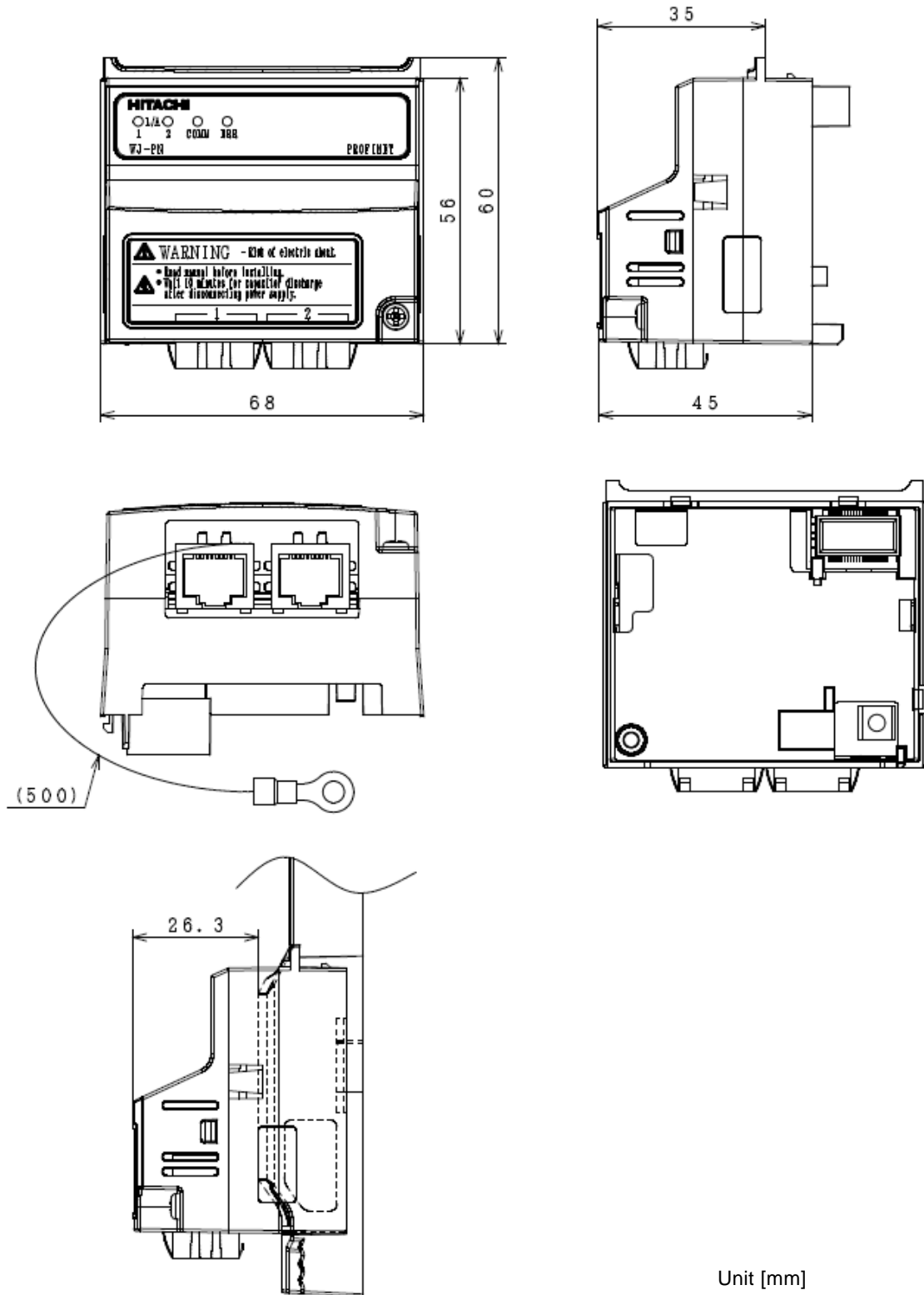

Appendix object list

Inverter parameters are allocated to objects 1000 to 1037 and 2000 to 2037.

1000 to 1037 are 2-byte parameters and 2000 to 2037 are 4-byte parameters.

The data in the table means the following.

- The data prefixed with "0x" means hexadecimal. From 'A' to 'F' are used to represent values from 10 to 15.
- The negative data are represented by two's complement.
- The other data is decimal.

Monitor mode: group d

Index	Sub-index	Register number	Size [bite]	Function code	Name	R/W	Description and range	Resolution	WJ200 only
2016	0x22	0x1001	04 (UDINT)	d001	Output frequency monitor	R	0 to 40000	0.01[Hz]	
1016	0x24	0x1003	02 (UINT)	d002	Output current monitor	R	0 to 65530	0.01[A]	
1016	0x25	0x1004	02 (UINT)	d003	Rotation direction monitor	R	0: forward 1: stop 2: reverse	-	
2016	0x26	0x1005	04 (UDINT)	d004	Process variable (PV), PID feedback monitor	R	0 to 1000000	0.1	
1016	0x28	0x1007	02 (UINT)	d005	Intelligent input terminal status	R	2 ⁰ : terminal 1 2 ¹ : terminal 2 2 ² : terminal 3 2 ³ : terminal 4 2 ⁴ : terminal 5 2 ⁵ : terminal 6 2 ⁶ : terminal 7	-	
1016	0x29	0x1008	02 (UINT)	d006	Intelligent output terminal status	R	2 ⁰ : terminal 11 2 ¹ : terminal 12 2 ⁶ : relay	-	
2016	0x2A	0x1009	04 (UDINT)	d007	Scaled output frequency monitor	R	0 to 4000000	0.01	
2016	0x2C	0x100B	04 (DINT)	d008	Actual frequency monitor	R	-40000 to 40000	0.01[Hz]	✓
1016	0x2E	0x100D	02 (INT)	d009	Torque command monitor	R	-200 to 200	1[%]	✓

Appendix PROFINET Object List

Index	Sub-index	Register number	Size [bite]	Function code	Name	R/W	Description and range	Resolution	WJ200 only
1016	0x2F	0x100E	02 (INT)	d010	Torque bias monitor	R	-200 to 200	1[%]	✓
1016	0x31	0x1010	02 (INT)	d012	Output torque monitor	R	-200 to 200	1[%]	✓
1016	0x32	0x1011	02 (UINT)	d013	Output voltage monitor	R	0 to 6000	0.1[V]	
1016	0x33	0x1012	02 (UINT)	d014	Input power monitor	R	0 to 1000	0.1[kW]	
2016	0x34	0x1013	04 (UDINT)	d015	Watt-hour monitor	R	0 to 99990000	0.1[kW]	
2016	0x36	0x1015	04 (UDINT)	d016	Elapsed RUN time monitor	R	0 to 999000	1[h]	
2016	0x38	0x1017	04 (UDINT)	d017	Elapsed power-on time monitor	R	0 to 999000	1[h]	
1016	0x3A	0x1019	02 (INT)	d018	Heat sink temperature monitor	R	-200 to 1500	0.1[°C]	
1016	0x3E	0x101D	02 (UINT)	d022	Life check monitor	R	2 ⁰ : Capacitor on the main board	Bit	
2016	0x57	0x1036	04 (DINT)	d029	Position setting monitor	R	-268435455 to 268435455	1	✓
2016	0x59	0x1038	04 (DINT)	d030	Position feedback monitor	R	-268435455 to 268435455	1	✓
1016	0x78	0x1057	02 (UINT)	d060	Inverter mode monitor	R	0: IM CT mode 3: PM motor	-	✓
1000	0x12	0x0011	02 (UINT)	d080	Trip Counter	R	0 to 65530	-	
1000	0x13	0x0012	02 (UINT)	d081	Trip information 1 (factor)	R	Please refer to section 9, factor code list	-	
1000	0x14	0x0013	02 (UINT)	d081	Trip information 1 (inverter status)	R	Please refer to section 9, status code list	-	
2000	0x15	0x0014	04 (UDINT)	d081	Trip information 1 (frequency)	R	Output frequency at trip point	0.01[Hz]	

Appendix PROFINET Object List

Index	Sub-index	Register number	Size [bite]	Function code	Name	R/W	Description and range	Resolution	WJ200 only
1000	0x17	0x0016	02 (UINT)	d081	Trip information 1 (current)	R	Motor current at trip point	0.01[A]	
1000	0x18	0x0017	02 (UINT)	d081	Trip information 1 (voltage)	R	DC bus voltage at trip point	0.1[V]	
2000	0x19	0x0018	04 (UDINT)	d081	Trip information 1 (running time)	R	Cumulative inverter operation time at trip point	1[h]	
2000	0x1B	0x001A	04 (UDINT)	d081	Trip information 1 (power-on time)	R	Cumulative power-ON time at trip point	1[h]	
1000	0x1D	0x001C	02 (UINT)	d082	Trip information 2 (factor)	R	Please refer to section 9, factor code list	-	
1000	0x1E	0x001D	02 (UINT)	d082	Trip information 2 (inverter status)	R	Please refer to section 9, status code list	-	
2000	0x1F	0x001E	04 (UDINT)	d082	Trip information 2 (frequency)	R	Output frequency at trip point	0.01[Hz]	
1000	0x21	0x0020	02 (UINT)	d082	Trip information 2 (current)	R	Motor current at trip point	0.01[A]	
1000	0x22	0x0021	02 (UINT)	d082	Trip information 2 (voltage)	R	DC bus voltage at trip point	0.1[V]	
2000	0x23	0x0022	04 (UDINT)	d082	Trip information 2 (running time)	R	Cumulative inverter operation time at trip point	1[h]	
2000	0x25	0x0024	04 (UDINT)	d082	Trip information 2 (power-on time)	R	Cumulative power-ON time at trip point	1[h]	
1000	0x27	0x0026	02 (UINT)	d083	Trip information 3 (factor)	R	Please refer to section 9, factor code list	-	
1000	0x28	0x0027	02 (UINT)	d083	Trip information 3 (inverter status)	R	Please refer to section 9, status code list	-	

Index	Sub-index	Register number	Size [bite]	Function code	Name	R/W	Description and range	Resolution	WJ200 only
2000	0x29	0x0028	04 (UDINT)	d083	Trip information 3 (frequency)	R	Output frequency at trip point	0.01[Hz]	
1000	0x2B	0x002A	02 (UINT)	d083	Trip information 3 (current)	R	Motor current at trip point	0.01[A]	
1000	0x2C	0x002B	02 (UINT)	d083	Trip information 3 (voltage)	R	DC bus voltage at trip point	0.1[V]	
2000	0x2D	0x002C	04 (UDINT)	d083	Trip information 3 (running time)	R	Cumulative inverter operation time at trip point	1[h]	
2000	0x2F	0x002E	04 (UDINT)	d083	Trip information 3 (power-on time)	R	Cumulative power-ON time at trip point	1[h]	
1000	0x31	0x0030	02 (UINT)	d084	Trip information 4 (factor)	R	Please refer to section 9, factor code list	-	
1000	0x32	0x0031	02 (UINT)	d084	Trip information 4 (inverter status)	R	Please refer to section 9, status code list	-	
2000	0x33	0x0032	04 (UDINT)	d084	Trip information 4 (frequency)	R	Output frequency at trip point	0.01[Hz]	
1000	0x35	0x0034	02 (UINT)	d084	Trip information 4 (current)	R	Motor current at trip point	0.01[A]	
1000	0x36	0x0035	02 (UINT)	d084	Trip information 4 (voltage)	R	DC bus voltage at trip point	0.1[V]	
2000	0x37	0x0036	04 (UDINT)	d084	Trip information 4 (running time)	R	Cumulative inverter operation time at trip point	1[h]	
2000	0x39	0x0038	04 (UDINT)	d084	Trip information 4 (power-on time)	R	Cumulative power-ON time at trip point	1[h]	
1000	0x3B	0x003A	02 (UINT)	d085	Trip information 5 (factor)	R	Please refer to section 9, factor code list	-	

Appendix PROFINET Object List

Index	Sub-index	Register number	Size [bite]	Function code	Name	R/W	Description and range	Resolution	WJ200 only
1000	0x3C	0x003B	02 (UINT)	d085	Trip information 5 (inverter status)	R	Please refer to section 9, status code list	-	
2000	0x3D	0x003C	04 (UDINT)	d085	Trip information 5 (frequency)	R	Output frequency at trip point	0.01[Hz]	
1000	0x3F	0x003E	02 (UINT)	d085	Trip information 5 (current)	R	Motor current at trip point	0.01[A]	
1000	0x40	0x003F	02 (UINT)	d085	Trip information 5 (voltage)	R	DC bus voltage at trip point	0.1[V]	
2000	0x41	0x0040	04 (UDINT)	d085	Trip information 5 (running time)	R	Cumulative inverter operation time at trip point	1[h]	
2000	0x43	0x0042	04 (UDINT)	d085	Trip information 5 (power-on time)	R	Cumulative power-ON time at trip point	1[h]	
1000	0x45	0x0044	02 (UINT)	d086	Trip information 6 (factor)	R	Please refer to section 9, factor code list	-	
1000	0x46	0x0045	02 (UINT)	d086	Trip information 6 (inverter status)	R	Please refer to section 9, status code list	-	
2000	0x47	0x0046	04 (UDINT)	d086	Trip information 6 (frequency)	R	Output frequency at trip point	0.01[Hz]	
1000	0x49	0x0048	02 (UINT)	d086	Trip information 6 (current)	R	Motor current at trip point	0.01[A]	
1000	0x4A	0x0049	02 (UINT)	d086	Trip information 6 (voltage)	R	DC bus voltage at trip point	0.1[V]	
2000	0x4B	0x004A	04 (UDINT)	d086	Trip information 6 (running time)	R	Cumulative inverter operation time at trip point	1[h]	

Index	Sub-index	Register number	Size [bite]	Function code	Name	R/W	Description and range	Resolution	WJ200 only
2000	0x4D	0x004B	04 (UDINT)	d086	Trip information 6 (power-on time)	R	Cumulative power-ON time at trip point	1[h]	
1000	0x4F	0x004E	02 (UINT)	d090	Warning monitor	R	Warning code	-	
1009	0x13	0x0900	02 (UINT)	-	Writing to the EEPROM	R/W	0: recalculation the constant of the motor 1: stored the setting value to the EEPROM The others: recalculation the constant of the motor, stored the setting value to the EEPROM	-	-
1009	0x15	0x0902	02 (UINT)	-	Writing mode selection	R/W	0: writing enabled 1: writing disabled	-	-
1016	0x47	0x1026	02 (UINT)	d102	DC bus voltage monitor	R	0 to 10000	0.1[V]	
1016	0x48	0x1027	02 (UINT)	d103	BRD load ratio monitor	R	0 to 1000	0.1[%]	
1016	0x49	0x1028	02 (UINT)	d104	Electronic thermal monitor	R	0 to 1000	0.1[%]	

Function mode: group F

Index	Sub-index	Register number	Size [bite]	Function code	Name	R/W	Description and range	Resolution	WJ200 only
2000	0x02	0x0001	04 (UDINT)	F001	Output frequency setting	R/W	0 to the maximum frequency (A004)	0.01[Hz]	
2017	0x26	0x1103	04 (UDINT)	F002	Acceleration (1) time	R/W	1 to 360000	0.01[s]	
2017	0x28	0x1105	04 (UDINT)	F003	Deceleration (1) time	R/W	1 to 360000	0.01[s]	
1017	0x2A	0x1107	02 (UINT)	F004	Keypad Run key routing	R/W	00: forward 01: reverse	-	
2033	0x46	0x2103	04 (UDINT)	F202	Acceleration (1) time, 2nd motor	R/W	1 to 360000	0.01[s]	

Appendix PROFINET Object List

Index	Sub-index	Register number	Size [bite]	Function code	Name	R/W	Description and range	Resolution	WJ200 only
2033	0x48	0x2105	04 (UDINT)	F203	Deceleration (1) time, 2nd motor	R/W	1 to 360000	0.01[s]	

Function mode: group A

Index	Sub-index	Register number	Size [bite]	Function code	Name	R/W	Description and range	Resolution	WJ200 only
1018	0x26	0x1201	02 (UINT)	A001	Frequency source	R/W	00: volume 01: control terminal 02: function F001 setting 03: Modbus network input 04: option board 06: pulse train input 07: EzSQ 10: calculate function output	-	
1018	0x27	0x1202	02 (UINT)	A002	Run command source	R/W	00: control terminal 01: run key on the keypad, or digital operator 02: Modbus network input 03: option	-	
1018	0x28	0x1203	02 (UINT)	A003	Base frequency	R/W	300 to the maximum frequency (A004)	0.1[Hz]	
1018	0x29	0x1204	02 (UINT)	A004	Maximum frequency	R/W	300 to 4000	0.1[Hz]	
1018	0x2A	0x1205	02 (UINT)	A005	[AT] selection	R/W	00: select between [O] and [OI] at [AT] (ON = OI, OFF = O) 02: select between [O] and external POT at [AT] (ON =POT, OFF = O) 03: select between [OI] and external POT at [AT] (ON =POT, OFF = OI)	-	
2018	0x30	0x120B	04 (UDINT)	A011	[O] input active range start frequency	R/W	0 to 40000	0.01[Hz]	

Appendix PROFINET Object List

Index	Sub-index	Register number	Size [bite]	Function code	Name	R/W	Description and range	Resolution	WJ200 only
2018	0x32	0x120D	04 (UDINT)	A012	[O] input active range end frequency	R/W	0 to 40000	0.01 [Hz]	
1018	0x34	0x120F	02 (UINT)	A013	[O] input active range start voltage	R/W	0 to 100	1 [%]	
1018	0x35	0x1210	02 (UINT)	A014	[O] input active range end voltage	R/W	0 to 100	1 [%]	
1018	0x36	0x1211	02 (UINT)	A015	[O] input start frequency enable	R/W	00: offset (A011 value) 01: 0 [Hz]	-	
1018	0x37	0x1212	02 (UINT)	A016	Analog input filter	R/W	1 to 30: x 2 [ms] filter 31: 500 [ms] fixed filter with plus or minus 0.1 [kHz] hysteresis	1	
1019	0x3A	0x1215	02 (UINT)	A019	Multi-speed operation selection	R/W	00: binary operation 01: bit operation	-	
2018	0x3B	0x1216	04 (UDINT)	A020	Multi-speed frequency 0	R/W	0 or start frequency to maximum frequency (A004)	0.01 [Hz]	
2018	0x3D	0x1218	04 (UDINT)	A021	Multi-speed frequency 1	R/W	0 or start frequency to the maximum frequency (A004)	0.01 [Hz]	
2018	0x3F	0x121A	04 (UDINT)	A022	Multi-speed frequency 2	R/W	0 or start frequency to maximum frequency (A004)	0.01 [Hz]	
2018	0x41	0x121C	04 (UDINT)	A023	Multi-speed frequency 3	R/W	0 or start frequency to maximum frequency (A004)	0.01 [Hz]	
2018	0x43	0x121E	04 (UDINT)	A024	Multi-speed frequency 4	R/W	0 or start frequency to maximum frequency (A004)	0.01 [Hz]	
2018	0x45	0x1220	04 (UDINT)	A025	Multi-speed frequency 5	R/W	0 or start frequency to maximum frequency (A004)	0.01 [Hz]	
2018	0x47	0x1222	04 (UDINT)	A026	Multi-speed frequency 6	R/W	0 or start frequency to maximum frequency (A004)	0.01 [Hz]	
2018	0x49	0x1224	04 (UDINT)	A027	Multi-speed frequency 7	R/W	0 or start frequency to maximum frequency (A004)	0.01 [Hz]	

Appendix PROFINET Object List

Index	Sub-index	Register number	Size [bite]	Function code	Name	R/W	Description and range	Resolution	WJ200 only
2018	0x4B	0x1226	04 (UDINT)	A028	Multi-speed frequency 8	R/W	0 or start frequency to maximum frequency (A004)	0.01[Hz]	
2018	0x4D	0x1228	04 (UDINT)	A029	Multi-speed frequency 9	R/W	0 or start frequency to maximum frequency (A004)	0.01[Hz]	
2018	0x4F	0x122A	04 (UDINT)	A030	Multi-speed frequency 10	R/W	0 or start frequency to maximum frequency (A004)	0.01[Hz]	
2018	0x51	0x122C	04 (UDINT)	A031	Multi-speed frequency 11	R/W	0 or start frequency to maximum frequency (A004)	0.01[Hz]	
2018	0x53	0x122E	04 (UDINT)	A032	Multi-speed frequency 12	R/W	0 or start frequency to maximum frequency (A004)	0.01[Hz]	
2018	0x55	0x1230	04 (UDINT)	A033	Multi-speed frequency 13	R/W	0 or start frequency to maximum frequency (A004)	0.01[Hz]	
2018	0x57	0x1232	04 (UDINT)	A034	Multi-speed frequency 14	R/W	0 or start frequency to maximum frequency (A004)	0.01[Hz]	
2018	0x59	0x1234	04 (UDINT)	A035	Multi-speed frequency 15	R/W	0 or start frequency to maximum frequency (A004)	0.01[Hz]	
1018	0x5D	0x1238	02 (UINT)	A038	Jog frequency	R/W	start frequency to 9.99	0.01[Hz]	
1018	0x5E	0x1239	02 (UINT)	A039	Jog mode stop	R/W	00: free-run stop (invalid during run) 01: controlled deceleration (invalid during run) 02: DC breaking to stop (invalid during run) 03: free-run stop (valid during run) 04: controlled deceleration (valid during run) 05: DC breaking to stop (valid during run)	-	
1018	0x60	0x123B	02 (UINT)	A041	Torque boost select	R/W	00: manual torque boost 01: automatic torque boost	-	

Index	Sub-index	Register number	Size [bite]	Function code	Name	R/W	Description and range	Resolution	WJ200 only
1018	0x61	0x123C	02 (UINT)	A042	Manual torque boost value	R/W	0 to 200	0.1[%]	
1018	0x62	0x123D	02 (UINT)	A043	Manual torque boost frequency	R/W	0 to 500	0.1[%]	
1018	0x63	0x123E	02 (UINT)	A044	V/f characteristic curve	R/W	00: constant torque 01: reduced torque 02: free V/f 03: sensorless vector (SLV)	-	
1018	0x64	0x123F	02 (UINT)	A045	V/f gain	R/W	20 to 100	1[%]	
1018	0x65	0x1240	02 (UINT)	A046	Voltage compensation gain for automatic torque boost	R/W	0 to 255	1[%]	
1018	0x66	0x1241	02 (UINT)	A047	Slip compensation gain for automatic torque boost	R/W	0 to 255	1[%]	
1018	0x6A	0x1245	02 (UINT)	A051	DC braking enable	R/W	00: disable 01: enable during stop 02: output frequency (A052)	-	
1018	0x6B	0x1246	02 (UINT)	A052	DC braking frequency	R/W	0 to 6000	0.01[Hz]	
1018	0x6C	0x1247	02 (UINT)	A053	DC braking wait time	R/W	0 to 50	0.1[s]	
1018	0x6D	0x1248	02 (UINT)	A054	DC braking force for deceleration	R/W	0 to 100	1[%]	
1018	0x6E	0x1249	02 (UINT)	A055	DC braking time for deceleration	R/W	0 to 600	0.1[s]	

Appendix PROFINET Object List

Index	Sub-index	Register number	Size [bite]	Function code	Name	R/W	Description and range	Resolution	WJ200 only
1018	0x6F	0x124A	02 (UINT)	A056	DC braking / edge or level detection for [DB] input	R/W	00: edge detection 01: level detection	-	
1018	0x70	0x124B	02 (UINT)	A057	DC braking force at start	R/W	0 to 100	1[%]	
1018	0x71	0x124C	02 (UINT)	A058	DC braking time at start	R/W	0 to 600	0.1[s]	
1018	0x72	0x124D	02 (UINT)	A059	Carrier frequency during DC braking	R/W	20 to 150	0.1[kHz]	
2018	0x74	0x124F	04 (UDINT)	A061	Frequency upper limit	R/W	0 or frequency lower limit (A062) to the maximum frequency (A004)	0.01[Hz]	
2018	0x76	0x1251	04 (UDINT)	A062	Frequency lower limit	R/W	0 or start frequency (b082) to frequency upper limit (A061)	0.01[Hz]	
2018	0x78	0x1253	04 (UDINT)	A063	Jump frequency (center) 1	R/W	0 to 40000	0.01[Hz]	
1018	0x7A	0x1255	02 (UINT)	A064	Jump frequency width (hysteresis) 1	R/W	0 to 1000	0.01[Hz]	
2018	0x7B	0x1256	04 (UDINT)	A065	Jump frequency (center) 2	R/W	0 to 40000	0.01[Hz]	
1018	0x7D	0x1258	02 (UINT)	A066	Jump frequency width (hysteresis) 2	R/W	0 to 1000	0.01[Hz]	
2018	0x7E	0x1259	04 (UDINT)	A067	Jump frequency (center) 3	R/W	0 to 40000	0.01[Hz]	

Index	Sub-index	Register number	Size [bite]	Function code	Name	R/W	Description and range	Resolution	WJ200 only
1018	0x80	0x125B	02 (UINT)	A068	Jump frequency width (hysteresis) ³	R/W	0 to 1000	0.01 [Hz]	
2018	0x81	0x125C	04 (UDINT)	A069	Acceleration hold frequency	R/W	0 to 40000	0.01 [Hz]	
1018	0x83	0x125E	02 (UINT)	A070	Acceleration hold time	R/W	0 to 600	0.1 [s]	
1018	0x84	0x125F	02 (UINT)	A071	PID select	R/W	00: disable 01: enable 02: enable with reverse output	-	
1018	0x85	0x1260	02 (UINT)	A072	PID proportional gain	R/W	2 to 2500	0.01	
1018	0x86	0x1261	02 (UINT)	A073	PID integral time constant	R/W	0 to 36000	0.1 [s]	
1018	0x87	0x1262	02 (UINT)	A074	PID derivative time constant	R/W	0 to 10000	0.01 [s]	
1018	0x88	0x1263	02 (UINT)	A075	PV scale conversion	R/W	1 to 9999	0.01	
1018	0x89	0x1264	02 (UINT)	A076	PV source	R/W	00: [OI] terminal (current in) 01: [O] terminal (voltage in) 02: Modbus network 03: Pulse train input 10: Calculate function output	-	
1018	0x8A	0x1265	02 (UINT)	A077	Reverse PID action	R/W	00: disabled 01: enabled	-	
1018	0x8B	0x1266	02 (UINT)	A078	PID output limit	R/W	0 to 1000	0.1 [%]	
1018	0x8C	0x1267	02 (UINT)	A079	PID feed forward selection	R/W	00: disable 01: [O] terminal (voltage in) 02: [OI] terminal (current in)	-	

Appendix PROFINET Object List

Index	Sub-index	Register number	Size [bite]	Function code	Name	R/W	Description and range	Resolution	WJ200 only
1018	0x8E	0x1269	02 (UINT)	A081	AVR function select	R/W	00: enabled 01: disabled 02: enabled except during deceleration	-	
1018	0x8F	0x126A	02 (UINT)	A082	AVR voltage select	R/W	00: 200 01: 215 02: 220 03: 230 04: 240	-	
1018	0x90	0x126B	02 (UINT)	A083	AVR filter time constant	R/W	0 to 10000	0.001[s]	
1018	0x91	0x126C	02 (UINT)	A084	AVR deceleration gain	R/W	50 to 200	1[%]	
1018	0x92	0x126D	02 (UINT)	A085	Energy-saving operation mode	R/W	00: normal operation 01: energy-saving operation	-	
1018	0x93	0x126E	02 (UINT)	A086	Energy-saving mode tuning	R/W	0 to 1000	0.1[%]	
2018	0x99	0x1274	04 (UDINT)	A092	Acceleration time (2)	R/W	1 to 360000	0.01[s]	
2018	0x9B	0x1276	04 (UDINT)	A093	Deceleration time (2)	R/W	1 to 360000	0.01[s]	
1018	0x9D	0x1278	02 (UINT)	A094	Select method to switch to Acc2/Dec2 profile	R/W	00: 2CH input from the terminal 01: transition frequency 02: forward and reverse	-	
2018	0x9E	0x1279	04 (UDINT)	A095	Acc1 to Acc2 frequency transition point	R/W	0 to 40000	0.01[Hz]	
2018	0xA0	0x127B	04 (UDINT)	A096	Dec1 to Dec2 frequency transition point	R/W	0 to 40000	0.01[Hz]	

Index	Sub-index	Register number	Size [bite]	Function code	Name	R/W	Description and range	Resolution	WJ200 only
1018	0xA2	0x127D	02 (UINT)	A097	Acceleration curve selection	R/W	00: linear 01: S-curve 02: U-curve 03: inverse U-curve 04: EL S-curve	-	
1018	0xA3	0x127E	02 (UINT)	A098	Deceleration curve selection	R/W	00: linear 01: S-curve 02: U-curve 03: inverse U-curve 04: EL S-curve	-	
2018	0xA6	0x1281	04 (UDINT)	A101	[OI] input active range start frequency	R/W	0 to 40000	0.01 [Hz]	
2018	0xA8	0x1283	04 (UDINT)	A102	[OI] input active range end frequency	R/W	0 to 40000	0.01 [Hz]	
1018	0xAA	0x1285	02 (UINT)	A103	[OI] input active range start current	R/W	0 to 100	1 [%]	
1018	0xAB	0x1286	02 (UINT)	A104	[OI] input active range end current	R/W	0 to 100	1 [%]	
1018	0xAC	0x1287	02 (UINT)	A105	[OI] input start frequency select	R/W	00: offset (A101 value) 01: 0 [Hz]	-	
1018	0xCA	0x12A5	02 (UINT)	A131	Acceleration curve constant	R/W	01 to 10	-	
1018	0xCB	0x12A6	02 (UINT)	A132	Deceleration curve constant	R/W	01 to 10	-	
1018	0xD4	0x12AF	02 (UINT)	A141	A input select for calculate function	R/W	00: operator 01: volume 02: terminal [O] input 03: terminal [OI] input 04: Modbus network 05: option 07: pulse train input	-	

Appendix PROFINET Object List

Index	Sub-index	Register number	Size [bite]	Function code	Name	R/W	Description and range	Resolution	WJ200 only
1018	0xD5	0x12B0	02 (UINT)	A142	B input select for calculate function	R/W	00: operator 01: volume 02: terminal [O] input 03: terminal [OI] input 04: Modbus network 05: option 07: pulse train input		
1018	0xD6	0x12B1	02 (UINT)	A143	Calculation symbol	R/W	00: ADD (A141 + A142) 01: SUB (A141 - A142) 02: MUL (A141 x A142)		
2018	0xD8	0x12B3	04 (UDINT)	A145	ADD frequency	R/W	0 to 40000	0.01[Hz]	
1018	0xDA	0x12B5	02 (UINT)	A146	ADD direction select	R/W	00: plus (output frequency + A145) 01: minus (output frequency - A145)		
1018	0xDE	0x12B9	02 (UINT)	A150	Curvature of EL-S-curve at the start of acceleration	R/W	0 to 50	1[%]	✓
1018	0xDF	0x12BA	02 (UINT)	A151	Curvature of EL-S-curve at the end of acceleration	R/W	0 to 50	1[%]	✓
1018	0xE0	0x12BB	02 (UINT)	A152	Curvature of EL-S-curve at the start of deceleration	R/W	0 to 50	1[%]	✓

Index	Sub-index	Register number	Size [bite]	Function code	Name	R/W	Description and range	Resolution	WJ200 only
1018	0xE1	0x12BC	02 (UINT)	A153	Curvature of EL-S-curve at the end of deceleration	R/W	0 to 50	1[%]	✓
2018	0xE2	0x12BD	04 (UDINT)	A154	Deceleration hold frequency	R/W	0 to 40000	0.01[Hz]	
1018	0xE4	0x12BF	02 (UINT)	A155	Deceleration hold time	R/W	0 to 600	0.1[s]	
2018	0xE5	0x12C0	04 (UDINT)	A156	PID sleep function action threshold	R/W	0 to 40000	0.01[Hz]	
1018	0xE7	0x12C2	02 (UINT)	A157	PID sleep function action delay time	R/W	0 to 255	0.1[s]	
2018	0xEB	0x12C6	04 (UDINT)	A161	[VR] input active range start frequency	R/W	0 to 40000	0.01[Hz]	
2018	0xED	0x12C8	04 (UDINT)	A162	[VR] input active range end frequency	R/W	0 to 40000	0.01[Hz]	
1018	0xEF	0x12CA	02 (UINT)	A163	[VR] input active range start %	R/W	0 to 100	1[%]	
1018	0xF0	0x12CB	02 (UINT)	A164	[VR] input active range end %	R/W	0 to 100	1[%]	
1018	0xF1	0x12CC	02 (UINT)	A165	[VR] input start frequency select	R/W	00: offset (A161 value) 01: 0 [Hz]	-	

Appendix PROFINET Object List

Index	Sub-index	Register number	Size [bite]	Function code	Name	R/W	Description and range	Resolution	WJ200 only
1034	0x46	0x2201	02 (UINT)	A201	Frequency source, 2 nd motor	R/W	00: volume 01: control terminal 02: function F001 setting 03: Modbus network input 04: option board 06: pulse train input 07: EzSQ 10: calculate function output	-	
1034	0x47	0x2202	02 (UINT)	A202	Run command source, 2 nd motor	R/W	00: control terminal 01: run key on the keypad, or digital operator 02: Modbus network input 03: option	-	
1034	0x48	0x2203	02 (UINT)	A203	Base frequency, 2 nd motor	R/W	300 to the 2 nd maximum frequency (A204)	0.1[Hz]	
1034	0x49	0x2204	02 (UINT)	A204	Maximum frequency, 2 nd motor	R/W	300 to 4000	0.1[Hz]	
2034	0x5B	0x2216	04 (UDINT)	A220	Multi-speed frequency 0, 2 nd motor	R/W	0 or start frequency to the 2 nd maximum frequency (A204)	0.01[Hz]	
1034	0x80	0x223B	02 (UINT)	A241	Torque boost select, 2 nd motor	R/W	00: manual torque boost 01: automatic torque boost	-	
1034	0x81	0x223C	02 (UINT)	A242	Manual torque boost value, 2 nd motor	R/W	0 to 200	0.1[%]	
1034	0x82	0x223D	02 (UINT)	A243	Manual torque boost frequency, 2 nd motor	R/W	0 to 500	0.1[%]	

Index	Sub-index	Register number	Size [bite]	Function code	Name	R/W	Description and range	Resolution	WJ200 only
1034	0x83	0x223E	02 (UINT)	A244	V/f characteristic curve, 2 nd motor	R/W	00: constant torque 01: reduced torque 02: free V/f 03: sensorless vector (SLV)	-	
1034	0x84	0x223F	02 (UINT)	A245	V/f gain, 2 nd motor	R/W	20 to 100	1[%]	
1034	0x85	0x2240	02 (UINT)	A246	Voltage compensation gain for automatic torque boost, 2 nd motor	R/W	0 to 255	1[%]	
1034	0x86	0x2241	02 (UINT)	A247	Slip compensation gain for automatic torque boost, 2 nd motor	R/W	0 to 255	1[%]	
2034	0x94	0x224F	04 (UDINT)	A261	Frequency upper limit, 2 nd motor	R/W	0 or frequency lower limit (A062) to the 2 nd maximum frequency (A204)	0.01[Hz]	
2034	0x96	0x2251	04 (UDINT)	A262	Frequency lower limit, 2 nd motor	R/W	0 or start frequency (B082) to frequency upper limit 2 nd motor (A261)	0.01[Hz]	
1034	0xAE	0x2269	02 (UINT)	A281	AVR function select, 2 nd motor	R/W	00: enabled 01: disabled 02: enabled except during deceleration	-	
1034	0xAF	0x226A	02 (UINT)	A282	AVR voltage select, 2 nd motor	R/W	00: 200 01: 215 02: 220 03: 230 04: 240	-	
2034	0xB4	0x226F	04 (UDINT)	A292	Acceleration time (2), 2 nd motor	R/W	1 to 360000	0.01[s]	
2034	0xB6	0x2271	04 (UDINT)	A293	Deceleration time (2), 2 nd motor	R/W	1 to 360000	0.01[s]	

Appendix PROFINET Object List

Index	Sub-index	Register number	Size [bite]	Function code	Name	R/W	Description and range	Resolution	WJ200 only
1034	0xB8	0x2273	02 (UINT)	A294	Select method to switch to Acc2/Dec2 profile, 2 nd motor	R/W	00: 2CH input from the terminal 01: transition frequency 02: forward and reverse	-	
2034	0xB9	0x2274	04 (UDINT)	A295	Acc1 to Acc2 frequency transition point, 2 nd motor	R/W	0 to 40000	0.01[Hz]	
2034	0xBB	0x2276	04 (UDINT)	A296	Dec1 to Dec2 frequency transition point, 2 nd motor	R/W	0 to 40000	0.01[Hz]	

Function mode: group b

Index	Sub-index	Register number	Size [bite]	Function code	Name	R/W	Description and range	Resolution	WJ200 only
1019	0x28	0x1301	02 (UINT)	b001	Restart mode on power failure / under-voltage trip	R/W	00: alarm output after trip, no automatic restart. 01: restart at 0[Hz] 02: resume operation after frequency matching. 03: resume previous frequency after frequency matching, then decelerate to stop and display trip information 04: resume operation after active frequency matching	-	
1019	0x29	0x1302	02 (UINT)	b002	Allowable under-voltage power failure time	R/W	3 to 250	0.1[s]	

Index	Sub-index	Register number	Size [bite]	Function code	Name	R/W	Description and range	Resolution	WJ200 only
1019	0x2A	0x1303	02 (UINT)	b003	Retry wait time before motor restart	R/W	3 to 1000	0.1[s]	
1019	0x2B	0x1304	02 (UINT)	b004	Instantaneous power failure / under-voltage trip alarm enable	R/W	00: disabled 01: enabled 02: disabled during stop and decelerates to a stop	-	
1019	0x2C	0x1305	02 (UINT)	b005	Number of restarts on power failure / under-voltage trip events	R/W	00: restart 16 times 01: always restart	-	
2019	0x2E	0x1307	04 (UDINT)	b007	Restart frequency threshold	R/W	0 to 40000	0.01[Hz]	
1019	0x30	0x1309	02 (UINT)	b008	Restart mode on over voltage / over current trip	R/W	00: alarm output after trip, no automatic restart. 01: restart at 0[Hz] 02: resume operation after frequency matching. 03: resume previous frequency after frequency matching, then decelerate to stop and display trip information 04: resume operation after active frequency matching	-	
1019	0x32	0x130B	02 (UINT)	b010	Number of retry on over voltage / over current trip	R/W	1 to 3	1[times]	

Appendix PROFINET Object List

Index	Sub-index	Register number	Size [bite]	Function code	Name	R/W	Description and range	Resolution	WJ200 only
1019	0x33	0x130C	02 (UINT)	b011	Retry wait time on over voltage / over current trip	R/W	3 to 1000	0.1[s]	
1019	0x34	0x130D	02 (UINT)	b012	Level of electronic thermal	R/W	200 to 1000	0.1[%]	
1019	0x35	0x130E	02 (UINT)	b013	Electronic thermal characteristic	R/W	00: reduced torque 01: constant torque 02: free setting	-	
1019	0x37	0x1310	02 (UINT)	b015	Free setting electronic thermal frequency 1	R/W	0 to 400	1[Hz]	
1019	0x38	0x1311	02 (UINT)	b016	Free setting electronic thermal current 1	R/W	0 to 1000	0.1[%]	
1019	0x39	0x1312	02 (UINT)	b017	Free setting electronic thermal frequency 2	R/W	0 to 400	1[Hz]	
1019	0x3A	0x1313	02 (UINT)	b018	Free setting electronic thermal current 2	R/W	0 to 1000	0.1[%]	
1019	0x3B	0x1314	02 (UINT)	b019	Free setting electronic thermal frequency 3	R/W	0 to 400	1[Hz]	
1019	0x3C	0x1315	02 (UINT)	b020	Free setting electronic thermal current 3	R/W	0 to 1000	0.1[%]	

Index	Sub-index	Register number	Size [bite]	Function code	Name	R/W	Description and range	Resolution	WJ200 only
1019	0x3D	0x1316	02 (UINT)	b021	Overload restriction operation mode	R/W	00: disabled 01: enabled for acceleration and constant speed 02: enabled for constant speed only 03: enabled for acceleration and constant speed, increase speed at regeneration	-	
1019	0x3E	0x1317	02 (UINT)	b022	Overload restriction level	R/W	200 to 2000	0.1[%]	
1019	0x3F	0x1318	02 (UINT)	b023	Deceleration rate at overload restriction	R/W	1 to 30000	0.1[s]	
1019	0x40	0x1319	02 (UINT)	b024	Overload restriction operation mode 2	R/W	00: disabled 01: enabled for acceleration and constant speed 02: enabled for constant speed only 03: enabled for acceleration and constant speed, increase speed at regeneration	-	
1019	0x41	0x131A	02 (UINT)	b025	Overload restriction level 2	R/W	200 to 2000	0.1[%]	
1019	0x42	0x131B	02 (UINT)	b026	Deceleration rate 2 at overload restriction	R/W	1 to 30000	0.1[s]	
1019	0x43	0x131C	02 (UINT)	b027	OC suppression selection	R/W	00: disabled 01: enabled	-	
1019	0x44	0x131D	02 (UINT)	b028	Current level of active freq. matching	R/W	200 to 2000	0.1[%]	

Appendix PROFINET Object List

Index	Sub-index	Register number	Size [bite]	Function code	Name	R/W	Description and range	Resolution	WJ200 only
1019	0x45	0x131E	02 (UINT)	b029	Deceleration rate of active freq. matching	R/W	1 to 30000	0.1[s]	
1019	0x46	0x131F	02 (UINT)	b030	Start freq. of active freq. matching	R/W	00: frequency at previous shutoff 01: start from the maximum frequency 02: start from set frequency	-	
1019	0x47	0x1320	02 (UINT)	b031	Software lock mode selection	R/W	00: all parameters except b031 are locked when [SFT] terminal is ON 01: all parameters except b031 and output frequency F001 are locked when [SFT] terminal is ON 02: all parameters except b031 are locked 03: all parameters except b031 and output frequency F001 are locked 10: high level access including b031	-	
1019	0x49	0x1322	02 (UINT)	b033	Motor cable length parameter	R/W	5 to 20	-	
2019	0x4A	0x1323	04 (UDINT)	b034	Run/power ON warning time	R/W	0 to 65535	10[h]	
1019	0x4C	0x1325	02 (UINT)	b035	Rotation direction restriction	R/W	00: no restriction 01: reverse rotation is restricted 02: forward rotation is restricted	-	
1019	0x4D	0x1326	02 (UINT)	b036	Reduced voltage start selection	R/W	0 to 255	1	

Index	Sub-index	Register number	Size [bite]	Function code	Name	R/W	Description and range	Resolution	WJ200 only
1019	0x4E	0x1327	02 (UINT)	b037	Function code display restriction	R/W	00: full display 01: function-specific display 02: user setting (and B037) 03: data comparison display 04: basic display 05: monitor display only	-	
1019	0x4F	0x1328	02 (UINT)	b038	Initial display selection	R/W	000: initial display selection by SET key 001 to 060: d001 to d060 201: F001	-	
1019	0x50	0x1329	02 (UINT)	b039	Automatic user parameter registration	R/W	00: disabled 01: enabled	-	
1019	0x51	0x132A	02 (UINT)	b040	Torque limit selection	R/W	00: quadrant-specific setting mode 01: terminal-switching mode 02: analog voltage input mode [O] 03: option board	-	✓
1019	0x52	0x132B	02 (UINT)	b041	Torque limit 1 (fwd/power)	R/W	0 to 200 / 255 (no)	1[%]	✓
1019	0x53	0x132C	02 (UINT)	b042	Torque limit 2 (rev/regen.)	R/W	0 to 200 / 255 (no)	1[%]	✓
1019	0x54	0x132D	02 (UINT)	b043	Torque limit 3 (rev/power)	R/W	0 to 200 / 255(no)	1[%]	✓
1019	0x55	0x132E	02 (UINT)	b044	Torque limit 4 (fwd/regen.)	R/W	0 to 200 / 255(no)	1[%]	✓
1019	0x56	0x132F	02 (UINT)	b045	Torque LAD STOP selection	R/W	00: disabled 01: enabled	-	✓
1019	0x57	0x1330	02 (UINT)	b046	Reverse run protection	R/W	00: disabled 01: enabled	-	✓

Appendix PROFINET Object List

Index	Sub-index	Register number	Size [bite]	Function code	Name	R/W	Description and range	Resolution	WJ200 only
1019	0x5A	0x1333	02 (UINT)	b049	Dual Rating Selection	R/W	Do not use this object.	-	✓
1019	0x5B	0x1334	02 (UINT)	b050	Controlled deceleration on power loss	R/W	00: disabled 01: enabled (decelerates to a stop) 02: enabled (decelerates to a stop with DC bus voltage controlled) 03: enabled (decelerates to a stop with DC bus voltage controlled, then restart)	-	
1019	0x5C	0x1335	02 (UINT)	b051	DC bus voltage trigger level of ctrl. decel.	R/W	0 to 10000	0.1[V]	
1019	0x5D	0x1336	02 (UINT)	b052	Over-voltage threshold of ctrl. decel.	R/W	0 to 10000	0.1[V]	
2019	0x5E	0x1337	04 (UDINT)	b053	Deceleration time of ctrl. decel.	R/W	1 to 360000	0.01[s]	
1019	0x60	0x1339	02 (UINT)	b054	Initial freq. drop of ctrl. decel.	R/W	0 to 1000	0.01[Hz]	
1019	0x66	0x133F	02 (UINT)	b060	Maximum-limit level of window comparator (O)	R/W	0 to 100 (minimum-limit level: $b061 + b062 * 2$)[%]	1[%]	
1019	0x67	0x1340	02 (UINT)	b061	Minimum-limit level of window comparator (O)	R/W	0 to 100 (maximum-limit level: $b060 - b062 * 2$)[%]	1[%]	
1019	0x68	0x1341	02 (UINT)	b062	Hysteresis width of window comparator (O)	R/W	0 to 10 (maximum-limit level: $(b061 - b062) / 2$)[%]	1[%]	

Index	Sub-index	Register number	Size [bite]	Function code	Name	R/W	Description and range	Resolution	WJ200 only
1019	0x69	0x1342	02 (UINT)	b063	Maximum-limit level of window comparator (OI)	R/W	0 to 100 (minimum-limit level: $b064 + b066 * 2$)[%]	1[%]	
1019	0x6A	0x1343	02 (UINT)	b064	Minimum-limit level of window comparator (OI)	R/W	0 to 100 (maximum-limit level: $b063 - b066 * 2$)[%]	1[%]	
1019	0x6B	0x1344	02 (UINT)	b065	Hysteresis width of window comparator (OI)	R/W	0 to 10 (maximum-limit level: $(b063 - b064) / 2$)[%]	1[%]	
1019	0x70	0x1349	02 (UINT)	b070	Operation level at O disconnecti on	R/W	0 to 100 / 255(no)	1[%]	
1019	0x71	0x134A	02 (UINT)	b071	Operation level at OI disconnecti on	R/W	0 to 100 / 255(no)	1[%]	
1019	0x75	0x134E	02 (UINT)	b075	Ambient temperature setting	R/W	-10 to 50	1[°C]	
1019	0x78	0x1351	02 (UINT)	b078	Watt-hour clearance	R/W	00: OFF 01: ON (press STR - then clear)		
1019	0x79	0x1352	02 (UINT)	b079	Watt-hour display gain	R/W	1 to 1000	1	
1019	0x7C	0x1355	02 (UINT)	b082	Start frequency	R/W	10 to 999	0.01[Hz]	
1019	0x7D	0x1356	02 (UINT)	b083	Carrier frequency	R/W	20 to 150	0.1[kHz]	

Appendix PROFINET Object List

Index	Sub-index	Register number	Size [bite]	Function code	Name	R/W	Description and range	Resolution	WJ200 only
1019	0x7E	0x1357	02 (UINT)	b084	Initialization mode (parameters or trip history)	R/W	00: initialization disabled 01: clears trip history 02: initializes all parameters 03: clears trip history and initialize all parameters 04: clears tip history and initializes all parameters and EZSQ program	-	
1019	0x7F	0x1358	02 (UINT)	b085	Country for initialization	R/W	00: mode 0 01: mode 1	-	
1019	0x80	0x1359	02 (UINT)	b086	Frequency scaling conversion factor	R/W	1 to 9999	0.01	
1019	0x81	0x135A	02 (UINT)	b087	STOP key enable	R/W	00: enabled 01: disabled 02: enabled only reset	-	
1019	0x82	0x135B	02 (UINT)	b088	Restart mode after FRS	R/W	00: restart from 0[Hz] 01: restart form frequency detected from real speed of motor (frequency matching) 02: restart from frequency detected from real speed of motor (active frequency matching)	-	
1019	0x83	0x135C	02 (UINT)	b089	Automatic carrier frequency reduction	R/W	00: disabled 01: enabled, depending on the output current 02: enabled, depending on the heat-sink temperature	-	
1019	0x84	0x135D	02 (UINT)	b090	Dynamic braking usage ratio	R/W	0 to 1000	0.1[%]	

Appendix PROFINET Object List

Index	Sub-index	Register number	Size [bite]	Function code	Name	R/W	Description and range	Resolution	WJ200 only
1019	0x85	0x135E	02 (UINT)	b091	Stop mode selection	R/W	00: DEC (decelerate to stop) 01: FRS (free-run to stop)	-	
1019	0x86	0x135F	02 (UINT)	b092	Cooling fan control	R/W	disabled	-	
1019	0x87	0x1360	02 (UINT)	b093	Clear elapsed time of cooling fan	R/W	disabled	-	
1019	0x88	0x1361	02 (UINT)	b094	Initialization target data	R/W	00: all parameters 01: all parameters except in/output terminals and communication. 02: only registered parameters in U**** 03: all parameters except registered parameters in U*** and b037	-	
1019	0x89	0x1362	02 (UINT)	b095	Dynamic braking control (BRD) selection	R/W	00: disabled 01: enable during run only 02: enable always	-	
1019	0x8A	0x1363	02 (UINT)	b096	BRD activation level	R/W	330 to 380	1[V]	
1019	0x8B	0x1364	02 (UINT)	b097	BRD resistor value	R/W	Minimum resistance[ohm] to 600.0[ohm]	0.1[ohm]	
1019	0x8E	0x1367	02 (UINT)	b100	Free V/F setting, freq.1	R/W	0 to free V/F setting, frequency 2 (b102)	1[Hz]	
1019	0x8F	0x1368	02 (UINT)	b101	Free V/F setting, voltage.1	R/W	0 to 8000	0.1[V]	
1019	0x90	0x1369	02 (UINT)	b102	Free V/F setting, freq.2	R/W	0 to free V/F setting, frequency 3 (b104)	1[Hz]	
1019	0x91	0x136A	02 (UINT)	b103	Free V/F setting, voltage.2	R/W	0 to 8000	0.1[V]	

Appendix PROFINET Object List

Index	Sub-index	Register number	Size [bite]	Function code	Name	R/W	Description and range	Resolution	WJ200 only
1019	0x92	0x136B	02 (UINT)	b104	Free V/F setting, freq.3	R/W	0 to free V/F setting, frequency 4 (b106)	1[Hz]	
1019	0x93	0x136C	02 (UINT)	b105	Free V/F setting, voltage.3	R/W	0 to 8000	0.1[V]	
1019	0x94	0x136D	02 (UINT)	b106	Free V/F setting, freq.4	R/W	0 to free V/F setting, frequency 5 (b108)	1[Hz]	
1019	0x95	0x136E	02 (UINT)	b107	Free V/F setting, voltage.4	R/W	0 to 8000	0.1[V]	
1019	0x96	0x136F	02 (UINT)	b108	Free V/F setting, freq.5	R/W	0 to free V/F setting, frequency 6 (b110)	1[Hz]	
1019	0x97	0x1370	02 (UINT)	b109	Free V/F setting, voltage.5	R/W	0 to 8000	0.1[V]	
1019	0x98	0x1371	02 (UINT)	b110	Free V/F setting, freq.6	R/W	0 to free V/F setting, frequency 7 (b112)	1[Hz]	
1019	0x99	0x1372	02 (UINT)	b111	Free V/F setting, voltage.6	R/W	0 to 8000	0.1[V]	
1019	0x9A	0x1373	02 (UINT)	b112	Free V/F setting, freq.7	R/W	0 to 400	1[Hz]	
1019	0x9B	0x1374	02 (UINT)	b113	Free V/F setting, voltage.7	R/W	0 to 8000	0.1[V]	
1019	0xA2	0x137B	02 (UINT)	b120	Brake control enable	R/W	00: disabled 01: enabled	-	
1019	0xA3	0x137C	02 (UINT)	b121	Brake Wait Time for Release	R/W	0 to 500	0.01[s]	
1019	0xA4	0x137D	02 (UINT)	b122	Brake Wait Time for Acceleration	R/W	0 to 500	0.01[s]	
1019	0xA5	0x137E	02 (UINT)	b123	Brake Wait Time for Stopping	R/W	0 to 500	0.01[s]	

Index	Sub-index	Register number	Size [bite]	Function code	Name	R/W	Description and range	Resolution	WJ200 only
1019	0xA6	0x137F	02 (UINT)	b124	Brake Wait Time for Confirmation	R/W	0 to 500	0.01 [s]	
1019	0xA7	0x1380	02 (UINT)	b125	Brake release freq.	R/W	0 to 400	0.01 [Hz]	
1019	0xA8	0x1381	02 (UINT)	b126	Brake release current	R/W	0 to 2000	0.1 [%]	
1019	0xA9	0x1382	02 (UINT)	b127	Braking freq. setting	R/W	0 to 40000	0.01 [Hz]	
1019	0xAC	0x1385	02 (UINT)	b130	Deceleration overvoltage suppression enable	R/W	00: disabled 01: enabled 02: enabled with acceleration	-	
1019	0xAD	0x1386	02 (UINT)	b131	Decel. overvolt. suppress level	R/W	330 to 390	1 [V]	
1019	0xAE	0x1387	02 (UINT)	b132	Decel. overvolt. suppress const.	R/W	10 to 3000	0.01 [s]	
1019	0xAF	0x1388	02 (UINT)	b133	Decel. overvolt. suppress proportional gain	R/W	0 to 500	0.01	
1019	0xB0	0x1389	02 (UINT)	b134	Decel. overvolt. suppress integral time	R/W	0 to 1500	0.1 [s]	
1019	0xBB	0x1394	02 (UINT)	b145	GS input mode	R/W	00: no trip (hardware shutoff only) 01: trip	-	
1019	0xC0	0x1399	02 (UINT)	b150	Display ex.operator connected	R/W	1 to 0x60 (d001 to d060)	-	
1019	0xCA	0x13A3	02 (UINT)	b160	1st parameter of Dual Monitor	R/W	1 to 0x30 (d001 to d030)	-	

Appendix PROFINET Object List

Index	Sub-index	Register number	Size [bite]	Function code	Name	R/W	Description and range	Resolution	WJ200 only
1019	0xCB	0x13A4	02 (UINT)	b161	2nd parameter of Dual Monitor	R/W	1 to 0x30 (d001 to d030)	-	
1019	0xCD	0x13A5	02 (UINT)	b163	Frequency set in monitoring	R/W	00: disabled 01: enabled	-	
1019	0xCE	0x13A6	02 (UINT)	b164	Automatic return to the initial display	R/W	00: disabled 01: enabled	-	
1019	0xCF	0x13A7	02 (UINT)	b165	Ex. operator com. loss action	R/W	00: trip 01: trip after deceleration to a stop 02: ignored 03: coasting (FRS) 04: decelerations to a trip	-	
1019	0xD0	0x13A8	02 (UINT)	b166	Data Read/Write select	R/W	00: read/write OK 01: protected	-	
1019	0xD5	0x13A9	02 (UINT)	b171	Inverter mode selection	R/W	00: no function 01: standard induction motor 03: permanent magnetic motor	-	✓
1019	0xDE	0x13AE	02 (UINT)	b180	Initialization trigger	R/W	00: disabled 01: enabled	-	
1035	0x53	0x230C	02 (UINT)	b212	Level of electronic thermal, 2 nd motor	R/W	200 to 1000	0.1[%]	
1035	0x54	0x230D	02 (UINT)	b213	Electronic thermal characteristic, 2 nd motor	R/W	00: reduced torque 01: constant torque 02: free setting	-	

Index	Sub-index	Register number	Size [bite]	Function code	Name	R/W	Description and range	Resolution	WJ200 only
1035	0x5D	0x2316	02 (UINT)	b221	Overload restriction operation mode, 2 nd motor	R/W	00: disabled 01: enabled for acceleration and constant speed 02: enabled for constant speed only 03: enabled for acceleration and constant speed, increase speed at regeneration	-	
1035	0x5E	0x2317	02 (UINT)	b222	Overload restriction level, 2 nd motor	R/W	200 to 2000	0.1[%]	
1035	0x5F	0x2318	02 (UINT)	b223	Deceleration rate at overload restriction, 2 nd motor	R/W	1 to 30000	0.1[s]	

Function mode: group C

Index	Sub-index	Register number	Size [bite]	Function code	Name	R/W	Description and range	Resolution	WJ200 only
1020	0x2A	0x1401	02 (UINT)	C001	Input function [1]	R/W	00: Forward Run/Stop (FW)	-	
1020	0x2B	0x1402	02 (UINT)	C002	Input function [2]	R/W	01: Reverse Run/Stop (RV)	-	
1020	0x2C	0x1403	02 (UINT)	C003	Input function [3]	R/W	02: Multi-speed select 1 (CF1)	-	
1020	0x2D	0x1404	02 (UINT)	C004	Input function [4]	R/W	03: Multi-speed select 2 (CF2)	-	
1020	0x2E	0x1405	02 (UINT)	C005	Input function [5]	R/W	04: Multi-speed select 3 (CF3)	-	
1020	0x2F	0x1406	02 (UINT)	C006	Input function [6]	R/W	05: Multi-speed select 4 (CF4)	-	
1020	0x30	0x1407	02 (UINT)	C007	Input function [7]	R/W	06: Jogging (JG) 07: External DC breaking (DB) 08: Set (select) 2 nd motor data (SET) 09: 2-stage acceleration and	-	

Appendix PROFINET Object List

Index	Sub-index	Register number	Size [bite]	Function code	Name	R/W	Description and range	Resolution	WJ200 only
							deceleration (2CH) 11: free-run stop (FRS) 12: External trip (EXT) 13: unattended start protection (USP) 14: commercial power source switchover (CS) 15: software lock(SFT) 16: analog input voltage/current select (AT) 18: reset inverter (RS) 19: PTC thermistor thermal protection , C005 only (PTC) 20: start, 3-wire interface (STA) 21: stop, 3-wire interface (STP) 22: FWD, REV, 3-wire interface (F/R) 23: PID disable(PID) 24: PID reset (PIDC) 27: remote control up function (UP) 28: remote control down function (DOWN) 29: remote control data clearing (UDC) 31: operator control (OPE) 32: multi-speed select, bit operation bit 1 (SF1) 33: multi-speed select, bit operation bit 2 (SF2) 34: multi-speed select, bit operation bit 3(SF3) 35: multi-speed select, bit operation bit 4(SF4) 36: multi-speed		

Index	Sub-index	Register number	Size [bite]	Function code	Name	R/W	Description and range	Resolution	WJ200 only
							select, bit operation bit 5(SF5) 37: multi-speed select, bit operation bit 6(SF6) 38: multi-speed select, bit operation bit 7(SF7) 39: overload restriction source changeover (OLR) 40: torque limit selection (TL) 41: torque limit switch 1 (TQR1) 42: torque limit switch 2 (TQR2) 44: brake confirmation (BOK) 46: LAD cancellation (LAC) 47: pulse counter clear (PCLR) 50: ADD frequency enable (A145) (ADD) 51: force terminal mode (F-TM) 52: enable torque command input (ATR) 53: clear watt-hour data (KHC) 56: general purpose input 1 (MI1) 57: general purpose input 2 (MI2) 58: general purpose input 3 (MI3) 59: general purpose input 4 (MI4) 60: general purpose input 5 (MI5) 61: general purpose input 6 (MI6) 62: general purpose input 7 (MI7) 65: analog command		

Appendix PROFINET Object List

Index	Sub-index	Register number	Size [bite]	Function code	Name	R/W	Description and range	Resolution	WJ200 only
							hold (AHD) 66: multistage-position switch 1 (CP1) 67: multistage-position switch 2 (CP2) 68: multistage-position switch 3 (CP3) 69: limit signal of homing (ORL) 70: trigger signal of homing (ORG) 73: speed/position changeover (SPD) 77: GS1 input (GS1) 78: GS2 input (GS2) 81: start EzCOM (485) 82: executing EzSQ program (PRG) 83: retain output frequency (HLD) 84: permission of Run command (ROK) 85: rotation direction detection, C007 only (EB) 86: display limitation (DISP) no: no function (NO)		
1020	0x34	0x140B	02 (UINT)	C011	Input [1] active state	R/W	00: NO 01: NC	-	
1020	0x35	0x140C	02 (UINT)	C012	Input [2] active state	R/W	00: NO 01: NC	-	
1020	0x36	0x140D	02 (UINT)	C013	Input [3] active state	R/W	00: NO 01: NC	-	
1020	0x37	0x140E	02 (UINT)	C014	Input [4] active state	R/W	00: NO 01: NC	-	
1020	0x38	0x140F	02 (UINT)	C015	Input [5] active state	R/W	00: NO 01: NC	-	
1020	0x39	0x1410	02 (UINT)	C016	Input [6] active state	R/W	00: NO 01: NC	-	
1020	0x3A	0x1411	02 (UINT)	C017	Input [7] active state	R/W	00: NO 01: NC	-	

Appendix PROFINET Object List

Index	Sub-index	Register number	Size [bite]	Function code	Name	R/W	Description and range	Resolution	WJ200 only
1020	0x3E	0x1415	02 (UINT)	C021	Output [11] function	R/W	00: Run signal (RUN) 01: frequency arrival type 1-constant speed (FA1)	-	
1020	0x3F	0x1416	02 (UINT)	C022	Output [12] function	R/W	02: frequency arrival type 2-over frequency (FA2) 03: overload advance notice signal 1 (OL) 04: output deviation for PID signal (OD) 05: alarm signal (AL) 06: frequency arrival type 3-set frequency (FA3) 07: over/under torque signal (OTQ) 09: undervoltage (UV) 10: torque limit signal (TRQ) 11: Run time expired (RNT) 12: power ON time expired (ONT) 13: thermal warning (THM) 19: brake release signal (BRK) 20: brake error signal (BER) 21: 0[Hz] speed detection signal (ZS) 22: speed deviation excessive (DSE) 23: positioning completion (POK) 24: frequency arrival type 4-over frequency (FAT4) 25: frequency arrival type 5-set frequency (FAT5) 26: overload advance notice signal 2 (OL2) 27: analog voltage input disconnect	-	
1020	0x43	0x141A	02 (UINT)	C026	Alarm relay function	R/W		-	

Appendix PROFINET Object List

Index	Sub-index	Register number	Size [bite]	Function code	Name	R/W	Description and range	Resolution	WJ200 only
							detection (ODc) 28: analog current input disconnect detection (OIDc) 31: PID second stage output (FBV) 32: network disconnect detection (NDc) 33: logic output function 1 (LOG1) 34: logic output function 2 (LOG2) 35: logic output function 3 (LOG3) 39: capacitor life warning signal (WAC) 40: cooling fan warning signal (WAF) 41: starting contact signal (FR) 42: heat sink overheat warning (OHF) 43: low load detection (LOC) 44: general output 1 (MO1) 45: general output 2 (MO2) 46: general output 3 (MO3) 50: inverter ready signal (IRDY) 51: forward rotation (FWR) 52: reverse rotation (RVR) 53: major failure signal (MJA) 54: window comparator for analog voltage input (WCO) 55: window comparator for analog current input (WCOI) 58: frequency		

Index	Sub-index	Register number	Size [bite]	Function code	Name	R/W	Description and range	Resolution	WJ200 only
							command source (FREF) 59: Run command source (REF) 60: 2 nd motor selection (SETM) 62: STO (Safe Torque OFF) performance monitor (output [11] only)(EDM) 63: option card output (OPO) no: no function (NO)		
1020	0x44	0x141B	02 (UINT)	C027	[EO] terminal selection (pulse/PWM output)	R/W	00: output frequency (PWM) 01: output current (PWM) 02: output torque (PWM) 03: output frequency (pulse train) 04: output voltage (PWM) 05: input power (PWM) 06: electronic thermal load ratio (PWM) 07: LAD frequency (PWM) 08: output current (pulse train) 10: heat sink temperature (PWM) 12: general output (PWM) 15: pulse train input monitor 16: option (PWM)		
1020	0x45	0x141C	02 (UINT)	C028	[AM] terminal selection (analog voltage output 0 to 10[V])	R/W	00: output frequency 01: output current 02: output torque 04: output voltage 05: input power 06: electronic thermal load ratio		

Appendix PROFINET Object List

Index	Sub-index	Register number	Size [bite]	Function code	Name	R/W	Description and range	Resolution	WJ200 only
							07: LAD frequency 10: heat sink temperature 11: output torque (with code) 13: general output 16: option		
1020	0x47	0x141E	02 (UINT)	C030	Digital current monitor reference value	R/W	200 to 2000	0.1[%]	
1020	0x48	0x141F	02 (UINT)	C031	Output [11] active state	R/W	00: NO 01: NC	-	
1020	0x49	0x1420	02 (UINT)	C032	Output [12] active state	R/W	00: NO 01: NC	-	
1020	0x4D	0x1424	02 (UINT)	C036	Alarm relay active state	R/W	00: NO 01: NC	-	
1020	0x4F	0x1426	02 (UINT)	C038	Output mode of low current detection	R/W	00: during acceleration, deceleration and constant speed 01: during constant speed only	-	
1020	0x50	0x1427	02 (UINT)	C039	Low current detection level	R/W	0 to 2000	0.1[%]	
1020	0x51	0x1428	02 (UINT)	C040	Output mode of overload warning	R/W	00: during acceleration, deceleration and constant speed 01: during constant speed only	-	
1020	0x52	0x1429	20 (UINT)	C041	Overload warning level	R/W	0 to 2000	0.1[%]	
2020	0x53	0x142A	04 (UDINT)	C042	Frequency arrival setting for acceleration	R/W	0 to 40000	0.01[Hz]	
2020	0x55	0x142C	04 (UDINT)	C043	Frequency arrival setting for deceleration	R/W	0 to 40000	0.01[Hz]	

Index	Sub-index	Register number	Size [bite]	Function code	Name	R/W	Description and range	Resolution	WJ200 only
					n				
1020	0x57	0x142E	02 (UINT)	C044	PID deviation level	R/W	0 to 1000	0.1[%]	
2020	0x58	0x142F	04 (UDINT)	C045	Frequency arrival setting 2 for acceleration	R/W	0 to 40000	0.01[Hz]	
2020	0x5A	0x1431	04 (UDINT)	C046	Frequency arrival setting 2 for deceleration	R/W	0 to 40000	0.01[Hz]	
1020	0x5C	0x1433	02 (UINT)	C047	Pulse train input/output scale conversion	R/W	0 to 100	-	✓
1020	0x61	0x1438	02 (UINT)	C052	PID FBV output high limit	R/W	0 to 1000	0.1[%]	
1020	0x62	0x1439	02 (UINT)	C053	PID FBV output low limit	R/W	0 to 1000	0.1[%]	
1020	0x63	0x143A	02 (UINT)	C054	Over-torque /under-torque selection	R/W	00: over-torque 01: under-torque	-	✓
1020	0x64	0x143B	02 (UINT)	C055	Over/under-torque level (Forward powering mode)	R/W	0 to 200	1[%]	✓
1020	0x65	0x143C	02 (UINT)	C056	Over/under-torque level (Reverse regen. mode)	R/W	0 to 200	1[%]	✓
1020	0x66	0x143D	02 (UINT)	C057	Over/under-torque level (Reverse powering mode)	R/W	0 to 200	1[%]	✓

Appendix PROFINET Object List

Index	Sub-index	Register number	Size [bite]	Function code	Name	R/W	Description and range	Resolution	WJ200 only
1020	0x67	0x143E	02 (UINT)	C058	Over/under-torque level (Forward regen. mode)	R/W	0 to 200	1[%]	✓
1020	0x68	0x143F	02 (UINT)	C059	Signal output mode of Over/under-torque	R/W	00: during acceleration, deceleration and constant speed 01: during constant speed only	-	✓
1020	0x6A	0x1441	02 (UINT)	C061	Electronic thermal warning level	R/W	0 to 100	1[%]	
1020	0x6C	0x1443	02 (UINT)	C063	Zero speed detection level	R/W	0 to 10000	0.01[Hz]	
1020	0x6D	0x1444	02 (UINT)	C064	Heat sink overheat warning	R/W	0 to 110	1[°C]	
1020	0x74	0x144B	02 (UINT)	C071	Communication speed	R/W	03: 2400[bps] 04: 4800[bps] 05: 9600[bps] 06: 19200[bps] 07: 38400[bps] 08: 57600[bps] 09: 76800[bps] 10: 115200[bps]	-	
1020	0x75	0x144C	02 (UINT)	C072	Modbus address	R/W	1 to 247	1	
1020	0x77	0x144E	02 (UINT)	C074	Communication parity	R/W	00: no parity 01: even parity 02: odd parity	-	
1020	0x78	0x144F	02 (UINT)	C075	Communication stop bit	R/W	01: 1[bit] 02: 2[bit]	-	
1020	0x79	0x1450	02 (UINT)	C076	Communication error select	R/W	00: trip 01: deceleration to a stop and trip 02: disabled 03: free run stop 04: deceleration to a stop	-	
1020	0x7A	0x1451	02	C077	Communication	R/W	0 to 9999	0.01[s]	

Appendix PROFINET Object List

Index	Sub-index	Register number	Size [bite]	Function code	Name	R/W	Description and range	Resolution	WJ200 only
			(UINT)		tion error time-out				
1020	0x7B	0x1452	02 (UINT)	C078	Communication wait time	R/W	0 to 1000	1[ms]	
1020	0x7E	0x1455	02 (UINT)	C081	Oil input span calibration	R/W	0 to 2000	0.1[%]	
1020	0x7F	0x1456	02 (UINT)	C082	OI input span calibration	R/W	0 to 2000	0.1[%]	
1020	0x82	0x1459	02 (UINT)	C085	Thermistor input (PTC) span calibration	R/W	0 to 2000	0.1[%]	
1020	0x88	0x145F	02 (UINT)	C091	Debug mode enable	R/W	00: disabled 01: enabled	-	
1020	0x8D	0x1464	02 (UINT)	C096	Communication selection	R/W	00: Modbus-RTU 01: EzCOM 02: EzCOM (administrator)	-	
1020	0x8F	0x1466	02 (UINT)	C098	EzCOM start address of master	R/W	1 to 8	1	
1020	0x90	0x1467	02 (UINT)	C099	EzCOM end address of master	R/W	1 to 8	1	
1020	0x91	0x1468	02 (UINT)	C100	EzCOM starting trigger	R/W	00: input terminal 01: always	-	
1020	0x92	0x1469	02 (UINT)	C101	Up/Down memory mode selection	R/W	00: clear last frequency 01: keep last frequency adjusted by UP/DOWN	-	
1020	0x93	0x146A	02 (UINT)	C102	Reset selection	R/W	00: cancel trip state at input signal ON transition, stops inverter if in Run Mode 01: cancel trip state at signal OFF transition, stops inverter if in Run	-	

Appendix PROFINET Object List

Index	Sub-index	Register number	Size [bite]	Function code	Name	R/W	Description and range	Resolution	WJ200 only
							Mode 02: cancel trip state at input ON transition, no effect if in Run Mode 03: clear the memories only related to trip status		
1020	0x94	0x146B	02 (UINT)	C103	Restart mode after reset	R/W	00: start with 0 Hz 01: start with frequency matching 02: start with active frequency matching	-	
1020	0x95	0x146C	02 (UINT)	C104	UP/DWN clear mode	R/W	00: 0[Hz] 01: original setting (in the EEPROM memory at power on)	-	
1020	0x96	0x146D	02 (UINT)	C105	FM gain adjustment	R/W	50 to 200	1[%]	
1020	0x97	0x146E	02 (UINT)	C106	AM gain adjustment	R/W	50 to 200	1[%]	
1020	0x9A	0x1471	02 (UINT)	C109	AM bias adjustment	R/W	0 to 100	1[%]	
1020	0x9C	0x1473	02 (UINT)	C111	Overload warning level 2	R/W	0 to 2000	0.1[%]	
1020	0xAF	0x1486	02 (UINT)	C130	Output [11] on delay	R/W	0 to 1000	0.1[s]	
1020	0xB0	0x1487	02 (UINT)	C131	Output [11] off delay	R/W	0 to 1000	0.1[s]	
1020	0xB1	0x1488	02 (UINT)	C132	Output [12] on delay	R/W	0 to 1000	0.1[s]	
1020	0xB2	0x1489	02 (UINT)	C133	Output [12] off delay	R/W	0 to 1000	0.1[s]	
1020	0xB9	0x1490	02 (UINT)	C140	Relay output on delay	R/W	0 to 1000	0.1[s]	
1020	0xBA	0x1491	02 (UINT)	C141	Relay output off delay	R/W	0 to 1000	0.1[s]	
1020	0xBB	0x1492	02 (UINT)	C142	Logic output 1 operand A	R/W	All the programmable functions available for logic (discrete) outputs except LOG1 to LOG3, OPO, no	-	

Appendix PROFINET Object List

Index	Sub-index	Register number	Size [bite]	Function code	Name	R/W	Description and range	Resolution	WJ200 only
1020	0xBC	0x1493	02 (UINT)	C143	Logic output operand B	1 R/W	All the programmable functions available for logic (discrete) outputs except LOG1 to LOG3, OPO, no	-	
1020	0xBD	0x1494	02 (UINT)	C144	Logic output operator	1 R/W	00: AND 01: OR 02: XOR	-	
1020	0xBE	0x1495	02 (UINT)	C145	Logic output operand A	2 R/W	All the programmable functions available for logic (discrete) outputs except LOG1 to LOG3, OPO, no	-	
1020	0xBF	0x1496	02 (UINT)	C146	Logic output operand B	2 R/W	All the programmable functions available for logic (discrete) outputs except LOG1 to LOG3, OPO, no	-	
1020	0xC0	0x1497	02 (UINT)	C147	Logic output operator	2 R/W	00: AND 01: OR 02: XOR	-	
1020	0xC1	0x1498	02 (UINT)	C148	Logic output operand A	3 R/W	All the programmable functions available for logic (discrete) outputs except LOG1 to LOG3, OPO, no	-	
1020	0xC2	0x1499	02 (UINT)	C149	Logic output operand B	3 R/W	All the programmable functions available for logic (discrete) outputs except LOG1 to LOG3, OPO, no	-	
1020	0xC3	0x149A	02 (UINT)	C150	Logic output operator	3 R/W	00: AND 01: OR 02: XOR	-	
1020	0xCD	0x14A4	02 (UINT)	C160	Input response time [1]	R/W	0 to 200	1	
1020	0xCE	0x14A5	02 (UINT)	C161	Input response time [2]	R/W	0 to 200	1	
1020	0xCF	0x14A6	02 (UINT)	C162	Input response time [3]	R/W	0 to 200	1	
1020	0xD	0x14A7	02	C163	Input [4]	R/W	0 to 200	1	

Appendix PROFINET Object List

Index	Sub-index	Register number	Size [bite]	Function code	Name	R/W	Description and range	Resolution	WJ200 only
	0		(UINT)		response time				
1020	0xD1	0x14A8	02 (UINT)	C164	Input response time [5]	R/W	0 to 200	1	
1020	0xD2	0x14A9	02 (UINT)	C165	Input response time [6]	R/W	0 to 200	1	
1020	0xD3	0x14AA	02 (UINT)	C166	Input response time [7]	R/W	0 to 200	1	
1020	0xD6	0x14AB	02 (UINT)	C169	Multistage speed/position determination time	R/W	0 to 200	1	
1036	0x72	0x2429	02 (UINT)	C241	Overload warning level, 2 nd motor	R/W	0 to 2000	0.1[%]	

Function mode: group H

Index	Sub-index	Register number	Size [bite]	Function code	Name	R/W	Description and range	Resolution	WJ200 only
1021	0x2C	0x1501	02 (UINT)	H001	Auto-tuning selection	R/W	00: disabled 01: enabled with motor stop 02: enabled with motor rotation	-	✓
1021	0x2D	0x1502	02 (UINT)	H002	Motor constant selection	R/W	00: Hitachi standard motor 02: auto-tuning data	-	✓

Appendix PROFINET Object List

Index	Sub-index	Register number	Size [bite]	Function code	Name	R/W	Description and range	Resolution	WJ200 only
1021	0x2E	0x1503	02 (UINT)	H003	Motor capacity	R/W	00: 0.1[kW] 01: 0.2[kW] 02: 0.4[kW] 03: 0.55[kW] 04: 0.75[kW] 05: 1.1[kW] 06: 1.5[kW] 07: 2.2[kW] 08: 3.0[kW] 09: 3.7[kW] 10: 4.0[kW] 11: 5.5[kW] 12: 7.5[kW] 13: 11.0[kW] 14: 15.0[kW] 15: 18.5[kW]	-	
1021	0x2F	0x1504	02 (UINT)	H004	Motor poles setting	R/W	00: 2[P] 01: 4[P] 02: 6[P] 03: 8[P] 04: 10[P]	-	
1021	0x31	0x1506	02 (UINT)	H005	Motor speed response constant	R/W	1 to 1000	1[%]	✓
1021	0x32	0x1507	02 (UINT)	H006	Motor stabilization constant	R/W	0 to 255	1	
1021	0x41	0x1516	02 (UINT)	H020	Motor constant R1	R/W	1 to 65535	0.001[Ω]	✓
1021	0x43	0x1518	02 (UINT)	H021	Motor constant R2	R/W	1 to 65535	0.001[Ω]	✓
1021	0x45	0x151A	02 (UINT)	H022	Motor constant L	R/W	1 to 65535	0.01[mH]	✓
1021	0x47	0x151C	02 (UINT)	H023	Motor constant I0	R/W	1 to 65535	0.01[A]	✓
2021	0x48	0x151D	04 (UDINT)	H024	Motor constant J	R/W	1 to 9999000	0.001 [kgm ²]	✓
1021	0x50	0x1525	02 (UINT)	H030	Motor constant R1 (Auto tuned data)	R/W	1 to 65535	0.001[ohm]	✓

Appendix PROFINET Object List

Index	Sub-index	Register number	Size [bite]	Function code	Name	R/W	Description and range	Resolution	WJ200 only
1021	0x52	0x1527	02 (UINT)	H031	Motor constant R2 (Auto tuned data)	R/W	1 to 65535	0.001[ohm]	✓
1021	0x54	0x152B	02 (UINT)	H032	Motor constant L (Auto tuned data)	R/W	1 to 65535	0.01[mH]	✓
1021	0x56	0x152B	02 (UINT)	H033	Motor constant I0 (Auto tuned data)	R/W	1 to 65535	0.01[A]	✓
2021	0x57	0x152C	04 (UDINT)	H034	Motor constant J (Auto tuned data)	R/W	1 to 9999000	0.001 [kgm ²]	✓
1021	0x68	0x153D	02 (UINT)	H050	Slip compensation P gain for V/f control with FB	R/W	0 to 10000	0.01	✓
1021	0x69	0x153E	02 (UINT)	H051	Slip compensation I gain for V/f control with FB	R/W	0 to 10000	1	✓
1021	0x9C	0x1571	02 (UINT)	H102	PM motor code setting	R/W	00: Hitachi standard motor 02: auto tuned data	-	✓

Index	Sub-index	Register number	Size [bite]	Function code	Name	R/W	Description and range	Resolution	WJ200 only
1021	0x9D	0x1572	02 (UINT)	H103	PM motor capacity	R/W	00: 0.1[kW] 01: 0.2[kW] 02: 0.4[kW] 03: 0.55[kW] 04: 0.75[kW] 05: 1.1[kW] 06: 1.5[kW] 07: 2.2[kW] 08: 3.0[kW] 09: 3.7[kW] 10: 4.0[kW] 11: 5.5[kW] 12: 7.5[kW] 13: 11.0[kW] 14: 15.0[kW] 15: 18.5[kW]	-	✓
1021	0x9E	0x1573	02 (UINT)	H104	PM motor pole setting	R/W	00: 2[P] 01: 4[P] 02: 6[P] 03: 8[P] 04: 10[P] 05: 12[P] 06: 14[P] 07: 16[P] 08: 18[P] 09: 20[P] 10: 22[P] 11: 24[P] 12: 26[P] 13: 28[P] 14: 30[P] 15: 32[P] 16: 34[P] 17: 36[P] 18: 38[P] 19: 40[P] 20: 42[P] 21: 44[P] 22: 46[P] 23: 48[P]	-	✓
1021	0x9F	0x1574	02 (UINT)	H105	PM Rated Current	R/W	0 to 1000	0.1[%]	✓
1021	0xA0	0x1575	02 (UINT)	H106	PM const R (Resistance)	R/W	1 to 65535	0.001[ohm]	✓

Appendix PROFINET Object List

Index	Sub-index	Register number	Size [bite]	Function code	Name	R/W	Description and range	Resolution	WJ200 only
1021	0xA1	0x1576	02 (UINT)	H107	PM const Ld (d-axis inductance)	R/W	1 to 65535	0.01[mH]	✓
1021	0xA2	0x1577	02 (UINT)	H108	PM const Lq (q-axis inductance)	R/W	1 to 65535	0.01[mH]	✓
1021	0xA3	0x1578	02 (UINT)	H109	PM const Ke (Induction voltage constant)	R/W	1 to 65535	0.0001 [Vpeak/(rad/s)]	✓
2021	0xA4	0x1579	04 (UDINT)	H110	PM const J (Moment of inertia)	R/W	1 to 9999000	0.001 [kgm ²]	✓
1021	0xA6	0x157B	02 (UINT)	H111	PM const R (Resistance, Auto)	R/W	1 to 65535	0.001[Ω]	✓
1021	0xA7	0x157C	02 (UINT)	H112	PM const Ld (d-axis inductance, Auto)	R/W	1 to 65535	0.01[mH]	✓
1021	0xA8	0x157D	02 (UINT)	H113	PM const Lq (q-axis inductance, Auto)	R/W	1 to 65535	0.01[mH]	✓
1021	0xAC	0x1581	02 (UINT)	H116	PM Speed Response	R/W	1 to 1000	1[%]	✓
1021	0xAD	0x1582	02 (UINT)	H117	PM Starting Current	R/W	2000 to 10000	0.01[%]	✓
1021	0xAE	0x1583	02 (UINT)	H118	PM Starting Time	R/W	1 to 6000	0.01[s]	✓
1021	0xAF	0x1584	02 (UINT)	H119	PM Stabilization Constant	R/W	0 to 120	1[%]	✓
1021	0xB1	0x1586	02 (UINT)	H121	PM Minimum Frequency	R/W	0 to 255	0.1[%]	✓
1021	0xB2	0x1587	02 (UINT)	H122	PM No-Load Current	R/W	0 to 10000	0.01[%]	✓
1021	0xB3	0x1588	02 (UINT)	H123	PM Starting Method Select	R/W	00: disabled 01: enabled	-	✓

Index	Sub-index	Register number	Size [bite]	Function code	Name	R/W	Description and range	Resolution	WJ200 only
1021	0xB5	0x158A	02 (UINT)	H131	PM Initial Magnet Position Estimation OV Wait Times	R/W	0 to 255	1	✓
1021	0xB6	0x158B	02 (UINT)	H132	PM Initial Magnet Position Estimation Detect Wait Times	R/W	0 to 255	1	✓
1021	0xB7	0x158C	02 (UINT)	H133	PM Initial Magnet Position Estimation Detect Times	R/W	0 to 255	1	✓
1021	0xB8	0x158D	02 (UINT)	H134	PM Initial Magnet Position Estimation Voltage Gain	R/W	0 to 255	1	✓
1037	0x4D	0x2502	02 (UINT)	H202	Motor constant selection, 2 nd motor	R/W	00: Hitachi standard motor 02: auto tuned data	-	✓
1037	0x4E	0x2503	02 (UINT)	H203	Motor capacity, 2 nd motor	R/W	00: 0.1[kW] 01: 0.2[kW] 02: 0.4[kW] 03: 0.55[kW] 04: 0.75[kW] 05: 1.1[kW] 06: 1.5[kW] 07: 2.2[kW] 08: 3.0[kW] 09: 3.7[kW] 10: 4.0[kW] 11: 5.5[kW] 12: 7.5[kW] 13: 11.0[kW] 14: 15.0[kW] 15: 18.5[kW]	-	

Appendix PROFINET Object List

Index	Sub-index	Register number	Size [bite]	Function code	Name	R/W	Description and range	Resolution	WJ200 only
1037	0x4F	0x2504	02 (UINT)	H204	Motor poles setting, 2 nd motor	R/W	00: 2[P] 01: 4[P] 02: 6[P] 03: 8[P] 04: 10[P]	-	
1037	0x51	0x2506	02 (UINT)	H205	Motor speed response constant, 2 nd motor	R/W	1 to 1000	1[%]	✓
1037	0x52	0x2507	02 (UINT)	H206	Motor stabilization constant, 2 nd motor	R/W	0 to 255	1	
1037	0x61	0x2516	02 (UINT)	H220	Motor constant R1, 2 nd motor (Hitachi motor)	R/W	1 to 65535	0.001[ohm]	✓
1037	0x63	0x2518	02 (UINT)	H221	Motor constant R2, 2 nd motor (Hitachi motor)	R/W	1 to 65535	0.001[ohm]	✓
1037	0x65	0x251A	02 (UINT)	H222	Motor constant L, 2 nd motor (Hitachi motor)	R/W	1 to 65535	0.01[mH]	✓
1037	0x67	0x251C	02 (UINT)	H223	Motor constant I0, 2 nd motor (Hitachi motor)	R/W	1 to 65535	0.01[A]	✓
2037	0x68	0x251D	04 (UDINT)	H224	Motor constant J, 2 nd motor (Hitachi motor)	R/W	1 to 9999000	0.001 [kgm ²]	✓

Index	Sub-index	Register number	Size [bite]	Function code	Name	R/W	Description and range	Resolution	WJ200 only
1037	0x70	0x2525	02 (UINT)	H230	Motor constant R1, 2nd motor (Auto tuned data)	R/W	1 to 65535	0.001[ohm]	✓
1037	0x72	0x2527	02 (UINT)	H231	Motor constant R2, 2nd motor (Auto tuned data)	R/W	1 to 65535	0.001[ohm]	✓
1037	0x74	0x2529	02 (UINT)	H232	Motor constant L, 2nd motor (Auto tuned data)	R/W	1 to 65535	0.01[mH]	✓
1037	0x76	0x252B	02 (UINT)	H233	Motor constant I0, 2nd motor (Auto tuned data)	R/W	1 to 65535	0.01[A]	✓
2037	0x77	0x252C	04 (UDINT)	H234	Motor constant J, 2nd motor (Auto tuned data)	R/W	1 to 9999000	0.001 [kgm ²]	✓

Function mode: group P

Index	Sub-index	Register number	Size [bite]	Function code	Name	R/W	Description and range	Resolution	WJ200 only
1022	0x2E	0x1601	02 (UINT)	P001	Reaction when option card error occurs	R/W	00: tripping 01: ignore the error (inverter continues operation)	-	
1022	0x30	0x1603	02 (UINT)	P003	[EA] terminal selection	R/W	00: speed reference (included PID) 01: for control with encoder feedback 02: extended terminal for EzSQ	-	✓

Appendix PROFINET Object List

Index	Sub-index	Register number	Size [bite]	Function code	Name	R/W	Description and range	Resolution	WJ200 only
1022	0x31	0x1604	02 (UINT)	P004	Pulse train input mode selection for feedback	R/W	00: Single-phase pulse [EA] 01: 2-phase pulse (90 degrees difference) 1 ([EA] and [EB]) 02: 2-phase pulse (90 degrees difference) 2 ([EA] and [EB]) 03: Single-phase pulse [EA] and direction signal [EB]	-	✓
1022	0x38	0x160B	02 (UINT)	P011	Encoder pulse setting	R/W	32 to 1024	1	✓
1022	0x39	0x160C	02 (UINT)	P012	Simple positioning selection	R/W	00: simple positioning deactivated 02: simple positioning activated	-	✓
1022	0x3C	0x160F	02 (UINT)	P015	Creep Speed	R/W	Start frequency (b082) to 1000	0.01[Hz]	✓
1022	0x47	0x161A	02 (UINT)	P026	Over-speed error detection level	R/W	0 to 1500	0.1[%]	✓
1022	0x48	0x161B	02 (UINT)	P027	Speed deviation error detection level	R/W	0 to 12000	0.01[Hz]	✓
1022	0x4C	0x161F	02 (UINT)	P031	Deceleration time Input Type	R/W	00: operator 03: EzSQ	-	
1022	0x4E	0x1621	02 (UINT)	P033	Torque command input selection	R/W	00: analog voltage input [O] 01: analog voltage input [OI] 03: operator 06: option	-	✓
1022	0x4F	0x1622	02 (UINT)	P034	Torque command level input	R/W	0 to 200	1[%]	✓

Appendix PROFINET Object List

Index	Sub-index	Register number	Size [bite]	Function code	Name	R/W	Description and range	Resolution	WJ200 only
1022	0x51	0x1624	02 (UINT)	P036	Torque bias mode selection	R/W	00: no bias 01: operator 05: option	-	✓
1022	0x52	0x1625	02 (UINT)	P037	Torque bias value setting	R/W	-200 to 200	1[%]	✓
1022	0x53	0x1626	02 (UINT)	P038	Torque bias polar selection	R/W	00: according to the sign 01: according to the rotation direction	-	✓
1022	0x55	0x1628	02 (UINT)	P039	Speed limit of Torque control (Forward rotation)	R/W	0 to 12000	0.01 [Hz]	✓
1022	0x57	0x162A	02 (UINT)	P040	Speed limit of Torque control (Forward rotation)	R/W	0 to 12000	0.01 [Hz]	✓
1022	0x58	0x162B	02 (UINT)	P041	Speed / Torque control switching time	R/W	0 to 1000	1 [ms]	✓
1022	0x5B	0x162E	02 (UINT)	P044	Communication watchdog timer (for option)	R/W	0 to 9999	0.01 [s]	
1022	0x5C	0x162F	02 (UINT)	P045	Inverter action on communication error (for option)	R/W	00: tripping 01: tripping after decelerating and stopping the motor 02: ignoring errors 03: stopping after free running 04: decelerating and stopping the motor	-	

Appendix PROFINET Object List

Index	Sub-index	Register number	Size [bite]	Function code	Name	R/W	Description and range	Resolution	WJ200 only
1022	0x60	0x1633	02 (UINT)	P049	Motor poles setting for RPM	R/W	00: 01: 2[P] 02: 4[P] 03: 6[P] 04: 8[P] 05: 10[P] 06: 12[P] 07: 14[P] 08: 16[P] 09: 18[P] 10: 20[P] 11: 22[P] 12: 24[P] 13: 26[P] 14: 28[P] 15: 30[P] 16: 32[P] 17: 34[P] 18: 36[P] 19: 38[P] 20: 40[P] 21: 42[P] 22: 44[P] 23: 46[P] 24: 48[P]	-	
1022	0x66	0x1639	02 (UINT)	P055	Pulse train input frequency scale setting	R/W	10 to 320	0.1[kHz]	✓
1022	0x67	0x163A	02 (UINT)	P056	Pulse train input frequency filter time constant setting	R/W	1 to 200	0.01[s]	✓
1022	0x68	0x163B	02 (UINT)	P057	Pulse train input bias setting	R/W	-100 to 100	1[%]	✓
1022	0x69	0x163C	02 (UINT)	P058	Limitation of the pulse train input setting	R/W	0 to 100	1[%]	✓
2022	0x6B	0x163E	04 (DINT)	P060	Multistage position 0	R/W	Position range (reverse: P073) to 1	1	✓

Appendix PROFINET Object List

Index	Sub-index	Register number	Size [bite]	Function code	Name	R/W	Description and range	Resolution	WJ200 only
2022	0x6D	0x1640	04 (DINT)	P061	Multistage position 1	R/W	position range (reverse)	1	✓
2022	0x6F	0x1642	04 (DINT)	P062	Multistage position 2	R/W		1	✓
2022	0x71	0x1644	04 (DINT)	P063	Multistage position 3	R/W		1	✓
2022	0x73	0x1646	04 (DINT)	P064	Multistage position 4	R/W		1	✓
2022	0x75	0x1648	04 (DINT)	P065	Multistage position 5	R/W		1	✓
2022	0x77	0x164A	04 (DINT)	P066	Multistage position 6	R/W		1	✓
2022	0x79	0x164C	04 (DINT)	P067	Multistage position 7	R/W		1	✓
1022	0x7B	0x164E	02 (UINT)	P068	Homing mode selection	R/W	00: low speed mode 01: high speed mode	-	✓
1022	0x7C	0x164F	02 (UINT)	P069	Homing direction	R/W	00: forward rotation mode 01: reverse rotation mode	-	✓
1022	0x7D	0x1650	02 (UINT)	P070	Low speed homing frequency	R/W	0 to 1000	0.01 [Hz]	✓
1022	0x7E	0x1651	02 (UINT)	P071	High speed homing frequency	R/W	0 to 40000	0.01 [Hz]	✓
2022	0x7F	0x1652	04 (DINT)	P072	Position range (forward)	R/W	0 to 268435455	1	✓
2022	0x81	0x1654	04 (DINT)	P073	Position range (reverse)	R/W	-268435455 to 0	1	✓
1022	0x84	0x1657	02 (UINT)	P075	Positioning mode selection	R/W	00: with limitation 01: no limitation	-	✓
1022	0x86	0x1659	02 (UINT)	P077	Encoder disconnection timeout	R/W	0 to 100	0.1 [s]	✓
1022	0xBB	0x168E	02 (UINT)	P140	EzCOM number of data	R/W	1 to 5	-	
1022	0xBC	0x168F	02 (UINT)	P141	EzCOM destination 1 address	R/W	1 to 247	-	

Appendix PROFINET Object List

Index	Sub-index	Register number	Size [bite]	Function code	Name	R/W	Description and range	Resolution	WJ200 only
1022	0xBD	0x1690	02 (UINT)	P142	EzCOM destination 1 register	R/W	0x0000 to 0xFFFF	-	
1022	0xBE	0x1691	02 (UINT)	P143	EzCOM source register 1	R/W	0x0000 to 0xFFFF	-	
1022	0xBF	0x1692	02 (UINT)	P144	EzCOM destination 2 addresss	R/W	1 to 247	-	
1022	0xC0	0x1693	02 (UINT)	P145	EzCOM destination 2 register	R/W	0x0000 to 0xFFFF	-	
1022	0xC1	0x1694	02 (UINT)	P146	EzCOM source register 2	R/W	0x0000 to 0xFFFF	-	
1022	0xC2	0x1695	02 (UINT)	P147	EzCOM destination 3 addresss	R/W	1 to 247	-	
1022	0xC3	0x1696	02 (UINT)	P148	EzCOM destination 3 register	R/W	0x0000 to 0xFFFF	-	
1022	0xC4	0x1697	02 (UINT)	P149	EzCOM source register 3	R/W	0x0000 to 0xFFFF	-	
1022	0xC5	0x1698	02 (UINT)	P150	EzCOM destination 4 addresss	R/W	1 to 247	-	
1022	0xC6	0x1699	02 (UINT)	P151	EzCOM destination 4 register	R/W	0x0000 to 0xFFFF	-	
1022	0xC7	0x169A	02 (UINT)	P152	EzCOM source register 4	R/W	0x0000 to 0xFFFF	-	
1022	0xC8	0x169B	02 (UINT)	P153	EzCOM destination 5 addresss	R/W	1 to 247	-	
1022	0xC9	0x169C	02 (UINT)	P154	EzCOM destination 5 register	R/W	0x0000 to 0xFFFF	-	
1022	0xCA	0x169D	02 (UINT)	P155	EzCOM source register 5	R/W	0x0000 to 0xFFFF	-	

Index	Sub-index	Register number	Size [bite]	Function code	Name	R/W	Description and range	Resolution	WJ200 only
1022	0xCF	0x16A2	02 (UINT)	P160	Option I/F command register to write 1	R/W	0x0000 to 0xFFFF	-	
1022	0xD0	0x16A3	02 (UINT)	P161	Option I/F command register to write 2	R/W	0x0000 to 0xFFFF	-	
1022	0xD1	0x16A4	02 (UINT)	P162	Option I/F command register to write 3	R/W	0x0000 to 0xFFFF	-	
1022	0xD2	0x16A5	02 (UINT)	P163	Option I/F command register to write 4	R/W	0x0000 to 0xFFFF	-	
1022	0xD3	0x16A6	02 (UINT)	P164	Option I/F command register to write 5	R/W	0x0000 to 0xFFFF	-	
1022	0xD4	0x16A7	02 (UINT)	P165	Option I/F command register to write 6	R/W	0x0000 to 0xFFFF	-	
1022	0xD5	0x16A8	02 (UINT)	P166	Option I/F command register to write 7	R/W	0x0000 to 0xFFFF	-	
1022	0xD6	0x16A9	02 (UINT)	P167	Option I/F command register to write 8	R/W	0x0000 to 0xFFFF	-	
1022	0xD7	0x16AA	02 (UINT)	P168	Option I/F command register to write 9	R/W	0x0000 to 0xFFFF	-	
1022	0xD8	0x16AB	02 (UINT)	P169	Option I/F command register to write 10	R/W	0x0000 to 0xFFFF	-	
1022	0xD9	0x16AC	02 (UINT)	P170	Option I/F command register to read 1	R/W	0x0000 to 0xFFFF	-	

Appendix PROFINET Object List

Index	Sub-index	Register number	Size [bite]	Function code	Name	R/W	Description and range	Resolution	WJ200 only
1022	0xD A	0x16AD	02 (UINT)	P171	Option I/F command register to read 2	R/W	0x0000 to 0xFFFF	-	
1022	0xD B	0x16AE	02 (UINT)	P172	Option I/F command register to read 3	R/W	0x0000 to 0xFFFF	-	
1022	0xD C	0x16AF	02 (UINT)	P173	Option I/F command register to read 4	R/W	0x0000 to 0xFFFF	-	
1022	0xD D	0x16B0	02 (UINT)	P174	Option I/F command register to read 5	R/W	0x0000 to 0xFFFF	-	
1022	0xDE	0x16B1	02 (UINT)	P175	Option I/F command register to read 6	R/W	0x0000 to 0xFFFF	-	
1022	0xDF	0x16B2	02 (UINT)	P176	Option I/F command register to read 7	R/W	0x0000 to 0xFFFF	-	
1022	0xE0	0x16B3	02 (UINT)	P177	Option I/F command register to read 8	R/W	0x0000 to 0xFFFF	-	
1022	0xE1	0x16B4	02 (UINT)	P178	Option I/F command register to read 9	R/W	0x0000 to 0xFFFF	-	
1022	0xE2	0x16B5	02 (UINT)	P179	Option I/F command register to read 10	R/W	0x0000 to 0xFFFF	-	

Operator display omitted:

Index	Sub-index	Register number	Size [bite]	Function code	Name	R/W	Description and range	Resolution	WJ200 only
1000	0x04	0x0003	02	-	Inverter status A	R	00 to 09	-	

Index	Sub-index	Register number	Size [bite]	Function code	Name	R/W	Description and range	Resolution	WJ200 only
1000	0x05	0x0004	02 (UINT)	-	Inverter status B	R	00 to 02	-	
1000	0x06	0x0005	02 (UINT)	-	Inverter status C	R	00 to 10	-	
1000	0x07	0x0006	02 (UINT)	-	PID feedback	R/W	0 to 10000	-	

Optional interface:

Index	Sub-index	Register number	Size [bite]	Function code	Name	R/W	Description and range	Resolution	WJ200 Only
1030	0x3E	0x1E01	02 (UINT)	-	Coil data 1	R	0x0000 to 0xFFFF	-	
1030	0x3F	0x1E02	02 (UINT)	-	Coil data 2	R	0x0000 to 0xFFFF	-	
1030	0x40	0x1E03	02 (UINT)	-	Coil data 3	R	0x0000 to 0xFFFF	-	
1030	0x41	0x1E04	02 (UINT)	-	Coil data 4	R	0x0000 to 0xFFFF	-	
1030	0x42	0x1E05	02 (UINT)	-	Coil data 5	R	0x0000 to 0xFFFF	-	
1031	0x40	0x1F01	02 (UINT)	-	Coil data 0	R/W	0x0000 to 0xFFFF	-	
1031	0x52	0x1F13	02 (UINT)	-	Setting output terminals	R/W	0x0000 to 0xFFFF	-	

PROFIdrive area

Index	Sub-index	Size [bite]	Name	R/W	Description and range	Default setting
915	0	UINT	Selection switch for DO IO Data in the setpoint telegram	R	0x0000 : STW1 The other :Modbus register No. of WJ200 / WL200	0x0000
	1	UINT	Selection switch for DO IO Data in the setpoint telegram	R	0x0000 : NSOLL_A The other :Modbus register No. of WJ200 / WL200	0x0000
	2-9	UINT	Selection switch for DO IO Data in the setpoint telegram	R	0x0000 : Unused The other :Modbus register No. of WJ200 / WL200	0x0000

Appendix PROFINET Object List

Index	Sub-index	Size [bite]	Name	R/W	Description and range	Default setting
916	0	UINT	Selection switch for DO IO Data in the actual value telegram	R	0x0000 : STW1 The other :Modbus register No. of WJ200 / WL200	0x0000
	1	UINT	Selection switch for DO IO Data in the actual value telegram	R	0x0000 : NSOLL_A The other :Modbus register No. of WJ200 / WL200	0x0000
	2 - 9	UINT	Selection switch for DO IO Data in the actual value telegram	R	0x0000 : Unused The other :Modbus register No. of WJ200 / WL200	0x0000
922		UINT	Telegram selection	R	1 : Standard telegram 1 103 : WJ-PN telegram 103 104 : WJ-PN telegram 104 105 : WJ-PN telegram 105	1
944		UINT	Fault message counter	R	The number of times that fault buffer is changes.	0
947	0x00 - 0x3F	UINT	Fault number	R	Fault number list that occurred in WJ200 / WL200 and WJ-PN.	1
952		UINT	Fault situation counter	RW	The number of fault situation since power on or the last reset. This parameter can be written only 0.	0
953		UINT	Warning parameters	R	Warning of WJ200 / WL200	0
954		UINT	Warning parameters	R	Warning of WJ-PN	0
964			Drive Unit identification		The information of WJ-PN	-
	0x00	UINT	Manufacturer	R	PROFINET vendor code	617
	0x01	UINT	Drive Unit type	R	Drive unit type code of WJ-PN is 0X0EFD.	0x0301
	0x02	UINT	Version (Software)	R	When version is xx.yy, this parameter is xxyy (decimal).	depends on shipment time
	0x03	UINT	Firmware date (year)	R	Year (decimal) that firmware of WJ-PN was created.	depends on shipment time
	0x04	UINT	Firmware date (day/month)	R	Day/month (ddmm : decimal) that firmware of WJ-PN was created.	depends on shipment time

Index	Sub-index	Size [bite]	Name	R/W	Description and range	Default setting
965		STR (2 characters))	Telegram selection	R	Profile number and profile version that WJ-PN supports.	0x32A
61000	0x00 ~ 0xEF	STR	NameOfStation	R	NameOfStation	-
61001	0x00 ~ 0x03	STR (2 characters)	IpOfStation	R	IP address	-
61002	0x00 ~ 0x05	STR (6 characters)	MacOfStation	R	MAC address	depends on device
61003	0x00 ~ 0x03	STR (4 characters)	StandardGatewayOfStation	R	Default gateway	-
61004	0x00 ~ 0x03	STR (4 characters)	SubnetMaskOfStation	R	Subnet mask	-