



Level



Pressure



Flow



Temperature

Liquid
Analysis

Registration

Systems
Components

Services



Solutions

Technical Information

Omnigrad S TMT162C

Thermocouple assembly
with HART[®]-, FOUNDATION Fieldbus[™]-
or PROFIBUS[®] PA field transmitter



Application

- Chemical/pharmaceutical industry
- Petrochemical industry
- Energy industry
- Paper industry
- General industrial applications

The TMT162C thermocouple thermometer comprises a measuring insert with a type J or K thermocouple and an electronic field transmitter with HART[®], FOUNDATION Fieldbus[™] or PROFIBUS[®] PA protocol.

Features and benefits

- Dual compartment housing
- Backlit display with large measured value, bargraph and fault condition indication
- Galvanic isolation 2 kV (sensor input to the output)
- Wide range of threaded thermowell connections available as standard, additional connections available on request
- Replaceable measuring insert comprising a mineral-insulated tube (SS 316L/1.4404)
- Thermocouple (type J or K) with accuracy class 1 or 2 (IEC 60584)
- Aluminum or stainless steel housing, degree of protection IP67, NEMA 4x
- Approvals for hazardous areas:
Flameproof enclosure (Ex d)
Intrinsic safety (Ex ia)
Non-sparking (Ex nA)
- Optional: 2 thermocouples can be connected, e.g. for redundant applications or differential measurement
- Optional factory calibration

Function and system design

Measuring principle

In the thermocouple, two electrically conductive conductors made of different metals are connected at the ends (thermocouple), thereby producing a thermoelectric circuit. The weld point forms the "measuring point" and the other end with the free wires forms the "cold junction". When the "measuring point" of this thermoelectric circuit is heated, a current flows through the circuit and a weak electrical voltage (known as the thermoelectric voltage) is generated.

If the measuring point and the reference junction have the same temperature, a thermoelectric voltage is not generated. The strength of the thermoelectric voltage (also known as the electromotive force), primarily depends on the materials of the thermocouple and the size of the temperature differential. The sensors (thermocouple) meet the requirements of IEC 60584 and ANSI MC96.1.

Measuring system

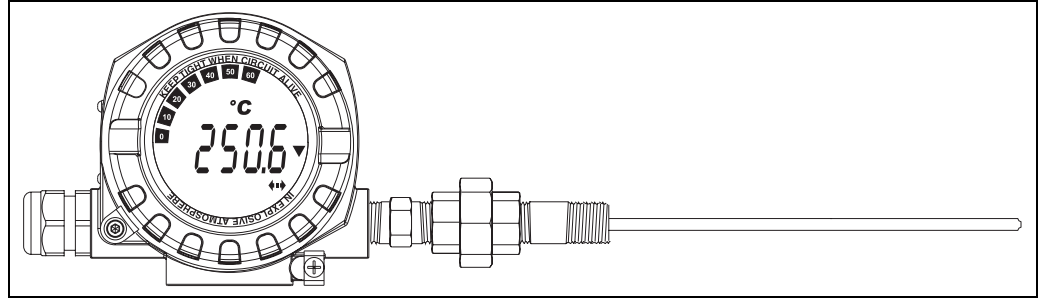

TMT162C

The TMT162C thermocouple thermometer comprises a measuring insert with a thermocouple (TC) and the iTEMP® TMT162 field transmitter which can be configured using the HART®, FOUNDATION Fieldbus™ or PROFIBUS® PA protocol. A thermowell can be ordered separately.

The sensor element is integrated in the tip of the measuring insert and complies with IEC 60584 and ANSI MC96.1. It withstands loads that typically occur in the most common industrial processes. The sensor element consists of 2 metal alloy wires, type J (iron/copper nickel) or type K (nickel chromium/nickel). The measuring range and tolerance errors differ depending on the thermocouple. The measuring insert is a replaceable unit and is installed in a thermowell. A spring system presses it against the base of the thermowell to improve the transmission of heat.

The transmitter housing is made of die-cast aluminum or stainless steel. It can be purchased with or without an LC display. The minimum degree of protection, IP65, is achieved by sealing glands at the cable entry and the thermometer connection. Depending on the customer's requirements, customers can choose from thermowells constructed from welded tubes and thermowells made of drilled barstock material. The thermowells are available in various shapes and sizes and with a wide range of process connections (thread, flange or weld-on connections, see page 12).

Measurement range

Input	Designation	Measuring range limits	Min. span
Thermocouples (TC) to IEC 60584 part 1	Type J (Fe-CuNi)	-210 to +1200 °C (-346 to 2192 °F)	50 K
	Type K (NiCr-Ni)	-270 to +1372 °C (-454 to 2501 °F)	50 K
<ul style="list-style-type: none"> ■ Internal cold junction (Pt100) ■ Accuracy of cold junction: ± 1 K ■ Max. sensor resistance 10 kΩ (if sensor resistance is greater than 10 kΩ, error message as per NAMUR NE 89) 			

Performance characteristics

Operating conditions

Ambient temperature limits

- Without display: -40 to +85 °C (-40 to 185 °F)
- With display: -40 to +80 °C (-40 to 176 °F)

For use in Ex area, see Ex certificate.

**Note!**

At temperatures $< -20\text{ °C}$ (-4 °F), the display may react slowly. Readability of the display cannot be guaranteed at temperatures $< -30\text{ °C}$ (-22 °F).

Storage temperature

- Without display: -40 to $+100\text{ °C}$ (-40 to 212 °F)
- With display: -40 to $+80\text{ °C}$ (-40 to 176 °F)

Process pressure/flow velocity

The load limits of the thermometer depend on the thermowell used and are listed in the technical information specific to the individual thermowells (see page 12). Factors that affect the load limits include the process pressure, flow velocity, density of the medium, temperature, immersion depth, length of the thermowell in the flowing medium etc. In critical situations, a load capacity calculation for the thermowell can be ordered from Endress+Hauser.

Shock and vibration resistance

3 g (max. value)/ 10 to 500 Hz as per IEC 60 068-2-6

Accuracy

Thermocouple corresponding to IEC 60584

Type	Standard tolerance (IEC 60584)		Reduced tolerance (IEC 60584)	
	Class	Deviation	Class	Deviation
J (Fe-CuNi)	2	$\pm 2.5\text{ °C}$ ($-40\dots 333\text{ °C}$) $\pm 0.0075\text{ t}l^1$ ($333\dots 750\text{ °C}$)	1	$\pm 1.5\text{ °C}$ ($-40\dots 375\text{ °C}$) $\pm 0.004\text{ t}l$ ($375\dots 750\text{ °C}$)
K (NiCr-Ni)	2	$\pm 2.5\text{ °C}$ ($-40\dots 333\text{ °C}$) $\pm 0.0075\text{ t}l$ ($333\dots 1200\text{ °C}$)	1	$\pm 1.5\text{ °C}$ ($-40\dots 375\text{ °C}$) $\pm 0.004\text{ t}l$ ($375\dots 1000\text{ °C}$)

1. t_l = absolute value °C

**Note!**

For measurement errors in °F , calculate using equations above in °C , then multiply the outcome by 1.8.

Response time

Tests in water at 0.4 m/s (1.3 ft/s), according to IEC 60584; 10 K temperature step changes; response time for the assembly without thermowell and transmitter:

- t_{50} : 2.5 s
- t_{90} : 7 s

Insulation resistance

Insulation resistance $\geq 100\text{ M}\Omega$ at ambient temperature.

Insulation resistance between each terminal and the sheath is tested with a voltage of 500 V DC.

Transmitter specifications

	TMT162 FF/PA	TMT162 HART®	
		Accuracy	
Accuracy	0.25 °C (0.45 °F)	Digital	D/A ¹
		typ. 0.25 °C (0.45 °F)	0.02%
Galvanic isolation (input/output)	U = 2 kV AC		

1. % relates to the set span. Total accuracy = digital + D/A, for 4 to 20 mA output

Self heating

Negligibly small

Material

Housing	Nameplate	Neck, insert
Die-cast aluminum housing AISi10Mg with powder coating on polyester basis	Aluminum AlMgI, anodized in black	Stainless steel 1.4404 (AISI 316L)
Stainless steel 1.4435 (AISI 316L)	1.4301 (AISI 304)	

Installation conditions**Orientation**

No restrictions

Electromagnetic compatibility (EMC)**CE Electromagnetic Compatibility Compliance**

EMC meets all relevant requirements listed under EN 61326 Series and NAMUR NE21. Details as per declaration of conformity.

This recommendation is a uniform and practical way of determining whether the devices used in laboratories and process control are immune to interference with an objective to increase its functional safety.

ESD (Electrostatic discharge)	IEC 61000-4-2	6 kV cont., 8 kV air	
Electromagnetic fields	IEC 61000-4-3	0.08 to 2 GHz (0.08 to 4 GHz for FF) 0.08 to 2 GHz for HART 2 to 2.7 GHz	10 V/m 10 V/m 30 V/m 1V/m
Burst (fast transient)	IEC 61000-4-4	1 kV (2 kV for HART)	
surge	IEC 61000-4-5	1 kV asym. (0.5 kV sym. for HART)	
Conducted RF	IEC 61000-4-6	0.01 to 80 MHz	10 V

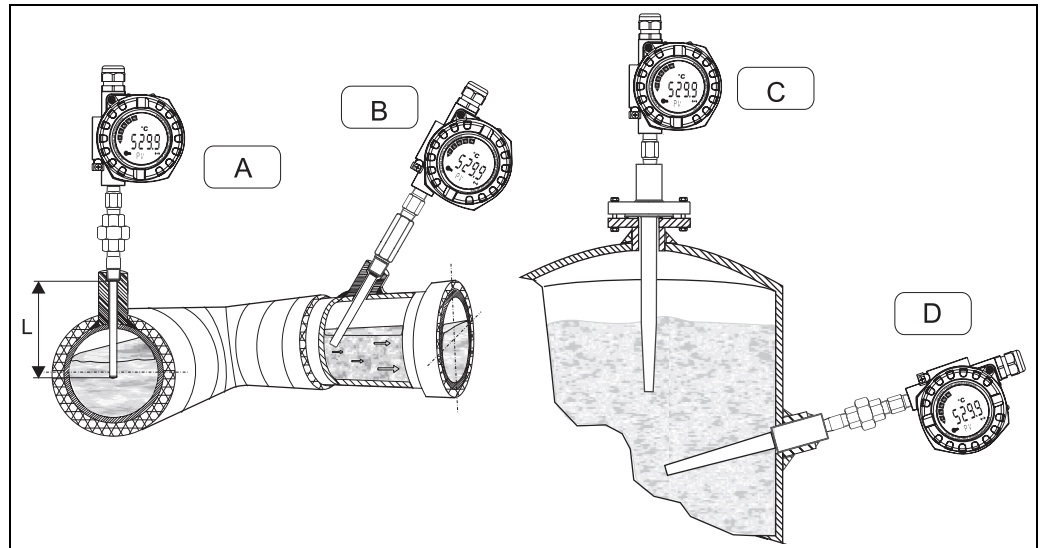
Installation instructions

Installation examples

A: In pipes with a small cross section the sensor tip should reach or extend slightly past the center line of the pipe ($= L$).

B, D: Tilted installation

C: Flanged installation

The immersion length of the thermometer influences the accuracy. If the immersion length is too small then errors in the measurement are caused by heat conduction via the process connection and the pipe wall. If installing into a pipe then the immersion length must be half of the pipe diameter, ideally.

- Installation possibilities: Pipes, tanks or other plant components
- Minimum immersion length = 80 to 100 mm (3.15 to 3.94 in)
The immersion length must be at least 8 times the protection tube diameter. Example: Protection tube diameter 12 mm (0.47 in) x 8 = 96 mm (3.8 in). Recommended standard immersion length according to DIN 43772: 120 mm (4.72 in)
- ATEX certification: Always take note of the installation regulations!



Note!

When operating in small nominal bore pipes it must be guaranteed that the protection tube tip is long enough to extend past the pipe center line (see Pos. A and B). A further solution could be an angled (tilted) installation (see Pos. C and D). When determining the immersion length all thermometer parameters and the process to be measured must be taken into account (e.g. flow velocity, process pressure).

In the case of pipes in which the direction of flow changes, extreme caution should be exercised when selecting the measuring point since these flows can cause the measured value to fluctuate. With regard to corrosion, the choice of material for the thermowell is particularly important.

If the thermometer is to be disassembled into its individual component parts, the specified tightening torques have to be observed when subsequently reassembling the thermometer in order to comply with the IP protection class of the coupling between the field transmitter and thermowell.

System components

Field transmitter









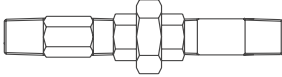
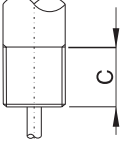

The field transmitter offers high reliability particularly in harsh industrial environments due to the dual compartment housing and fully potted electronics.

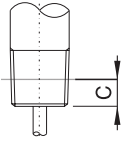
<p>Temperature field transmitter iTEMP® TMT162</p> <p>112 (4.41")</p> <p>110 (4.33")</p> <p>132,5 (5.22")*</p> <p>T09-TMT162ZZ-06-00-xx-xx-001</p> <p>* Dimensions without display = 112 mm (4.41")</p>	<ul style="list-style-type: none"> ■ Material: die-cast aluminum housing AlSi10Mg with powder coating on polyester base or stainless steel 1.4435 (AISI 316L) ■ Separate electronics compartment and connection compartment ■ Display pluggable in 90° stages ■ Cable entry: 2x ½" NPT, M20x1.5 ■ Thermowell connection (min. IP 65): M24x1.5, ½" NPT, ¾" NPT, G½" ■ Degree of protection IP 67 (NEMA 4X) ■ Blue backlit display with large measured value, bargraph and fault condition indication ■ Gold-plated terminals prevent corrosion and additional measured errors <p>For detailed information, see Technical Information iTEMP® TMT162 (see page 12).</p>
---	--

Neck tube

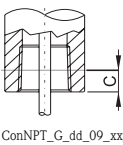
A neck tube is integrated between the thermowell and the field transmitter to prevent the field transmitter from overheating as a result of the process temperature. This neck tube is made up of one or more different pipe fittings (N, L = nipples and C, U = coupling, unions). The material of the neck tube is SS 316L/1.4404 as standard.

The neck tube versions and standard lengths (N) can be selected as follows:

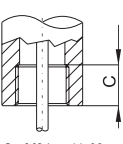
Neck tube versions							
Type	Neck tube type	Neck tube length N	Thermowell connection thread	Thread length C	Digit		
External thread	 LUN nckLUN_g_gd_15_xx_01	– 156 mm (6.14 in) (type LUN, field transmitter can be aligned) – 148 mm (5.83 in) (type LCN, field transmitter cannot be aligned)	G ½"	15 mm (0.6 in)	 ConGAS_G_dd_09_xx_01	D	
	 LCN nckLCN_g_gd_15_xx_01						
	 L* nckLxx_g_gd_15_01	– 52 mm (2 in) (type L, field transmitter cannot be aligned)	*only ½" NPT	8 mm (0.3 in)	 ConNPT_G_dd_09_xx_01	N	
	 LCN nckLUN_g_gd_15_xx_01	– 148 mm (5.83 in) (type LCN, field transmitter cannot be aligned)	½" NPT, ¾" NPT	8.5 mm (0.33 in)		 LUN nckLCN_g_gd_15_xx_01	P
<td rowspan="3">Internal thread</td> <td>  LU nckLUX_g_gd_15_xx_01 </td> <td> – 104 mm (4.1 in) (type LU, field transmitter can be aligned) </td> <td rowspan="2">½" NPT</td> <td rowspan="2"> 8 mm (0.3 in) </td> <td rowspan="2">  ConNPT_G_dd_09_xx_02 </td> <td rowspan="2">U</td>	Internal thread	 LU nckLUX_g_gd_15_xx_01			– 104 mm (4.1 in) (type LU, field transmitter can be aligned)		½" NPT
 LC nckLCx_g_gd_15_xx_01		– 96 mm (3.8 in) (type LC, field transmitter cannot be aligned)					
 LC nckLCx_g_gd_15_xx_01		– 96 mm (3.8 in) (type LC, field transmitter cannot be aligned)	M24x1.5	16 mm (0.63 in)	 ConM24_g_dd_09_xx_01	5	

In addition to the standard versions listed, neck tubes with specific lengths can be ordered as part of the product structure for the measuring insert.

As illustrated in the following figure, the neck tube length may influence the temperature in the field transmitter. It is necessary that this temperature is kept within the limit values defined in the chapter "Operating conditions".

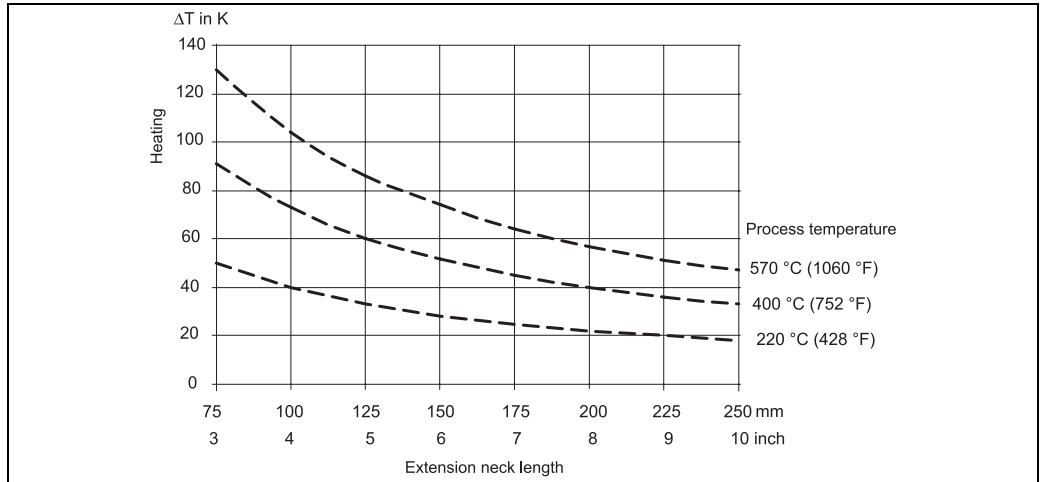

Heating of the field transmitter consequent to the process temperature.
 Temperature in the field transmitter = ambient temperature + ΔT

a0010513-en

Thermowell

The assembly is designed for installation in an existing thermowell, or a thermowell that has to be ordered separately. For this purpose, the neck tube connection to the thermowell is available in various sizes. To make selection easier, please use the table with the insertion lengths of the measuring insert (ML) which is described in the next section.

Measuring insert

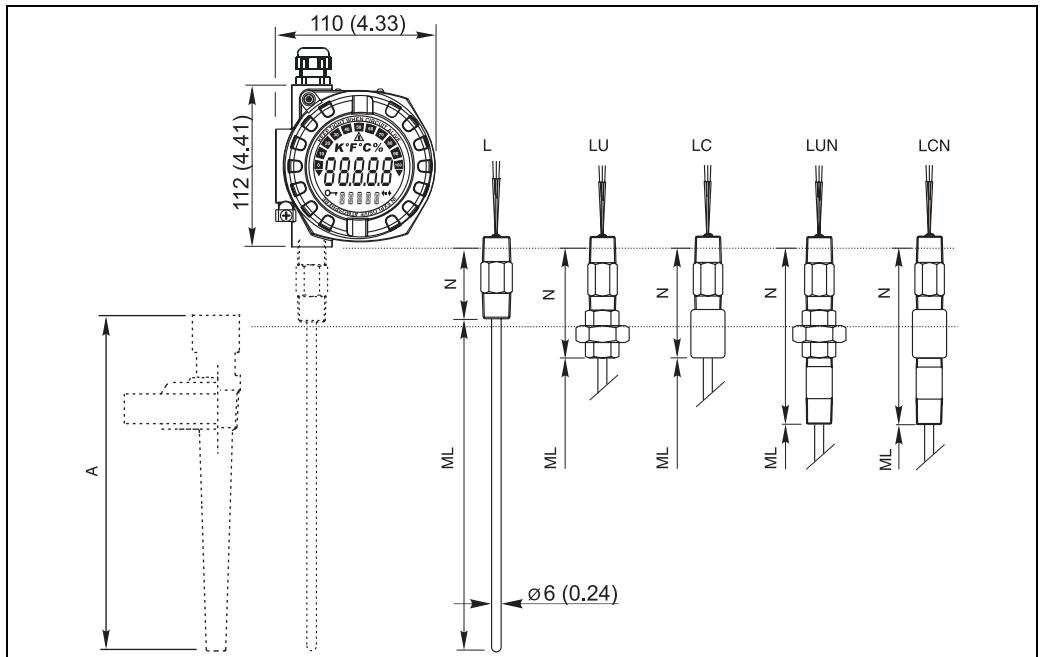

Omnigrad S TMT162C, dimensions in mm (inch)

T09-TMT162RC-04-xx-xx-xx-000

The insertion length (ML) of the measuring insert can be selected anywhere in the range between 50 and 990 mm (1.97 and 39 in). Insertion lengths over 990 mm (39 in) are available on request.

The insertion length (ML) must be selected depending on the total length of the thermowell (A) and the type of thermowell used (applies to standard thermowell base sizes). This also applies when ordering the measuring insert as a spare part. Please refer to the table below for exact details.

Thermowell type	ML in mm (inch)	Thermowell type	ML in mm (inch)	Thermowell type	ML in mm (inch)
TW10*	ML = A - 8 mm (0.31 in)	TA535	ML = A - 8 mm (0.31 in)	TA560	ML = A - 11 mm (0.43 in)
TW11*	ML = A - 8 mm (0.31 in)	TA540	ML = A - 10 mm (0.4 in)	TA566	ML = A - 11 mm (0.43 in)

Thermowell type	ML in mm (inch)	Thermowell type	ML in mm (inch)	Thermowell type	ML in mm (inch)
TW12*	ML = A - 8 mm (0.31 in)	TA541*	ML = A - 10 mm (0.4 in)	TA570	ML = A - 11 mm (0.43 in)
TW13*	ML = A - 8 mm (0.31 in)	TA550	ML = A - 11 mm (0.4 in)	TA571	ML = A - 11 mm (0.43 in)
TW10**	ML = A - 15 mm (0.6 in)	TA555	ML = A - 10 mm (0.4 in)	TA572	ML = A - 11 mm (0.43 in)
TW11**	ML = A - 15 mm (0.6 in)	TA556	ML = A - 10 mm (0.4 in)	TA575	ML = A - 11 mm (0.43 in)
TW12**	ML = A - 15 mm (0.6 in)	TA557	ML = A - 10 mm (0.4 in)	TA576	ML = A - 10 mm (0.4 in)
TW13**	ML = A - 15 mm (0.6 in)	TA562	ML = A - 11 mm (0.43 in)		
TW15**	ML = A - 12 mm (0.47 in)	TA565	ML = A - 11 mm (0.43 in)		

If the thermowell selected also contains a neck tube (e.g. TW15), the total length A of the thermowell is the sum of the length of the thermowell L plus the length of the neck tube E ($A = L + E$).



Caution!

* TMT162C with NPT threaded connection to the thermowell

** TMT162C with metric (M24x1.5) connection to the thermowell

Weight

From 1.5 to 5 kg (3.3 to 12.1 lbs) for standard options (aluminum housing).

Electronics

The iTEMP[®] temperature field transmitter TMT162 is a two-wire transmitter with analog output or fieldbus protocol, two (optional) measuring inputs for thermocouples type J or type K. The LC display shows the current measured value digitally and as a bar graph with an indicator for alarms.

Corrosion detection

Corrosion of the sensor connections can lead to corruption of the measured value. The field transmitter offers the option of detecting corrosion on thermocouples and resistance thermometers with a 4-wire connection before measured value corruption occurs.

If the conductor resistance exceeds plausible limits, the transmitter shows a status message on the display and forwards the corresponding message to the higher-order system via HART, FOUNDATION Fieldbus[™] or PROFIBUS[®] PA protocol.

Optional 2-channel functions

These functions increase the reliability and availability of the process values:

- Sensor backup switches to redundant sensor if primary sensor fails
- Temperature dependent switching between sensors, which have advantages in different ranges
- Drift alert or alarm if sensor 1 and 2 deviate from one another

Wiring diagram

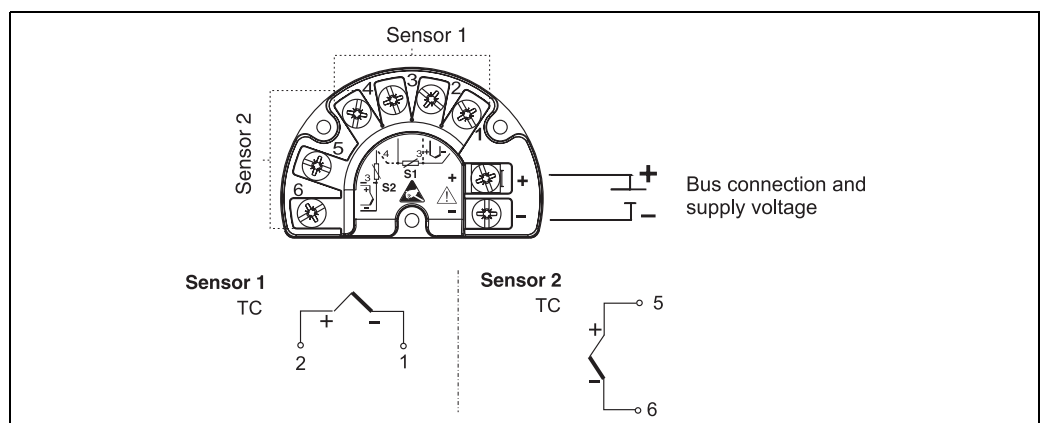

Electrical connection

TMT162Cx-04-xx-xx-en-000

Supply voltage

HART®
$U_b = 11$ to 40 V (8 to 40 V without display), reverse polarity protection  Note! (according to IEC 61010-1, CSA 1010.1-92) The TMT162 must be powered by a 11 to 40 VDC power supply with a limited power according to NEC Class 02 (low voltage, low current) limited to 8 A and 150 VA in case of a short circuit.

FOUNDATION Fieldbus™
$U_b = 9$ to 32 V, reverse polarity protection, max. voltage $U_b = 35$ V According to IEC 60079-27, FISCO/FNICO

PROFIBUS® PA
$U_b = 9$ to 32 V, reverse polarity protection, max. voltage $U_b = 35$ V According to IEC 60079-27, FISCO/FNICO

Certificates and approvals**CE-Mark**

The device meets the legal requirements of the EC directives. Endress+Hauser confirms that the device has been successfully tested by applying the CE mark.

Hazardous area approvals

ATEX II1G EEx ia IIC T6/T5/T4	HART®	FOUNDATION Fieldbus™/PROFIBUS® PA	
Power supply (+ and - terminals)	$U_i \leq 30$ V DC $I_i \leq 300$ mA $P_i \leq 1000$ mW $C_i \leq 5$ nF $L_i \approx 0$	$U_i \leq 17.5$ V DC or: $U_i \leq 24$ V DC $I_i \leq 500$ mA $P_i \leq 5.5$ W $C_i \leq 5$ nF $L_i = 10$ μH	$I_i \leq 250$ mA $P_i \leq 1.2$ W
		Suitable for connecting to a fieldbus system in accordance with the FISCO/FNICO model (valid for FOUNDATION Fieldbus™ protocol)	
ATEX II3G EEx nA II T6/T5/T4	HART®	FOUNDATION Fieldbus™	PROFIBUS® PA
Power supply (+ and - terminals)	$U \leq 40$ V DC	$U \leq 32$ V DC	
Output	$I = 4$ to 20 mA	Curr. consumption $I \leq 12$ mA	Curr. consumption $I \leq 11$ mA

ATEX II2D EEx tD A21 IP67 T110°C ATEX II2G EEx d IIC T6/T5/T4	HART®	FOUNDATION Fieldbus™ PROFIBUS® PA
Power supply (+ and - terminals)	$U \leq 40$ V DC $P \leq 3$ W	$U \leq 35$ V DC $P \leq 3$ W
Temperature range for Ex d (electronics)	T6 $T_a = -40$ °C to +55 °C T5 $T_a = -40$ °C to +70 °C T4 $T_a = -40$ °C to +80 °C	
Temperature range for dust (electronics)	$T_a = -40$ °C to +80 °C	

For further details on the available Ex versions (ATEX, CSA, FM, etc.), please contact your nearest Endress+Hauser sales organization. All relevant data for hazardous areas can be found in separate Ex documentation. If required, please request copies.

PED approval

The thermometer complies with paragraph 3.3 of the Pressure Equipment Directive (97/23/CE) and is not marked separately.

Test report and calibration

With regards to the tests and calibration, the "Inspection Report" consists of a compliance declaration for the essential points of the standard IEC 60584.

The "Factory calibration" is carried out in an EA (European Accreditation) authorized laboratory of Endress+Hauser according to an internal procedure. A calibration may be requested separately according to an EA accredited procedure (SIT calibration). Calibration is carried out on the thermometer insert.

Other standards and guidelines

- IEC 60529: Degree of protection by housing (IP-Code)
- IEC 61010-1: Safety requirements for electrical measurement, control and laboratory instrumentation.
- EN 61326-series: Electrical equipment for measurement, control and laboratory use - EMC requirements.
- NAMUR: User association of automation technology in process industries (www.namur.de)
- NEMA: Standardization association for the electrical industry in North America.

Ordering information

Product structure

TMT162C	Housing material; Approval	
A	Alu; housing, general purpose	
B	Alu; ATEX II1G EEx ia IIC T4/T5/T6	
E	Alu; ATEX II 2GD EEx d IIC T6	
H	Alu; ATEX EEx d, EEx ia	
L	Alu; ATEX II 3G EEx nA IIC T4/T5/T6	
M	Alu; ATEX II 1/2GD EEx d IIC T6	
P	316L; ATEX II 1G EEx ia IIC T4/T5/T6	
Q	316L; ATEX II 2GD EEx d IIC T6	
R	316L; ATEX II 1/2GD EEx d IIC T6	
T	Alu; ATEX II 1/2GD EEx ia IIC T4/T5/T6	
1	Alu; NEPSI Ex ia IIC T4-T6	
3	Alu; NEPSI Ex d IIC T4-T6	
	Cable connection; Display	
A	M20x1.5; w/o display, plug 7/8" FF	
B	M20x1.5; + display, plug 7/8" FF	
C	1/2" NPT; w/o display, plug 7/8" FF	
D	1/2" NPT; + display, plug 7/8" FF	
E	G1/2"; w/o display	
F	G1/2"; + display	
1	M20x1.5; w/o display	
2	M20x1.5; + display	
3	1/2" NPT; w/o display	
4	1/2" NPT; + display	
5	M20x1.5; w/o display, plug M12 PA	
6	M20x1.5; + display, plug M12 PA	
7	1/2" NPT; w/o display, plug M12 PA	
8	1/2" NPT; + display, plug M12 PA	
	Configuration; Communication	
B	TC; HART	
E	TC; PROFIBUS PA	
F	TC; FOUNDATION Fieldbus	
Y	Special version, to be specified	
	Neck length N; Type	
1	52 mm; nipple type L	
2	104 mm; nipple + union type LU	
3	96 mm; nipple + union type LC	
4	156 mm; nipple + union + nipple type LUN	
5	148 mm; nipple + union + nipple type LCN	
9	... mm, as specified	
	Thermowell type	
0	not needed	
1	Bar stock, to order separately	
2	Pipe, to order separately	
	Thermowell connection	
D	Thread G1/2"	
N	Thread 1/2" NPT-M	
P	Thread 3/4" NPT-M	
R	Thread R 1/2", JIS B 0203	
S	Thread R 3/4", JIS B 0203	

Documentation

Technical information:

- Thermocouple thermometer Omnigrad TSC - General information (TI090T/02)
- Temperature field transmitter iTEMP® TMT162 (TI086R/09/en)
- Thermocouple insert TC type K, J, T - Omniset TEC300 (TI226T/02/en)

Fitting thermowells:

- | | |
|--|---|
| <ul style="list-style-type: none">■ TW10 (TI261T/02)■ TW11 (TI262T/02)■ TW12 (TI263T/02)■ TW13 (TI264T/02)■ TW15 (TI265T/02)■ TA540 (TI166T/02) | <ul style="list-style-type: none">■ TA550 (TI153T/02)■ TA555 (TI154T/02)■ TA557 (TI156T/02)■ TA560 (TI159T/02)■ TA565 (TI160T/02)■ TA576 (TI163T/02) |
|--|---|

Operating instructions temperature field transmitter iTEMP® TMT162:

- HART®-protocol (BA132R/09/)
- FOUNDATION Fieldbus™-protocol (BA224R/09/)
- PROFIBUS® PA-protocol (BA275R/09/)

Hazardous area supplementary documentation:

- ATEX II 1G (XA005T/02/a3)
- ATEX II 1/2G or 2G, ATEX II 1/2D or 2D (XA006T/02/a3)

Instruments International

Endress+Hauser
Instruments International AG
Kaegenstrasse 2
4153 Reinach
Switzerland

Tel. +41 61 715 81 00
Fax +41 61 715 25 00
www.endress.com
info@ii.endress.com

Endress+Hauser 
People for Process Automation