

LCD

DIGITAL READOUTS

























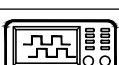

Driven by Innovation

Operation Manual

(Version 2.0)

Softkey Indication

| | | | |
|---|----------------------------|---|----------------------------|
|  | Distance to Go |  | System Parameter Setting |
| $\frac{ABS}{INC}$ | ABS/INC Conversion |  | Taper Measuring |
| $\frac{MM}{INCH}$ | Metric/Imperial Conversion |  | Grid Hole Function |
| SDM | SDM Coordinate |  | Bolt Hole Function |
| 1/2 | Value Half |  | Simple R Function |
|  | Set |  | Smooth R Function |
|  | Enter |  | Pocket Function |
|  | Exit |  | Tool Offsets Function |
|  | Radius/Diameter Conversion |  | Vectoring Function |
|  | Calculator |  | EDM Function |
|  | Axis Summing | V_0 | Value Zero of V axis |
|  | Signal Test | V | Value Preset of V axis |
|  | Help |  | Probe Measuring |
|  | REF Function |  | Projected Length Measuring |
|  | Circle Measuring |  | Angle Measuring Function |
| COMP. | Compensation |  | Sleep |

Calculator Function Key

| | | | | |
|----------|------------|------------|------------|------------|
| + | - | × | ÷ | = |
| √ | SIN | COS | TAN | ARC |

Keypad Layout

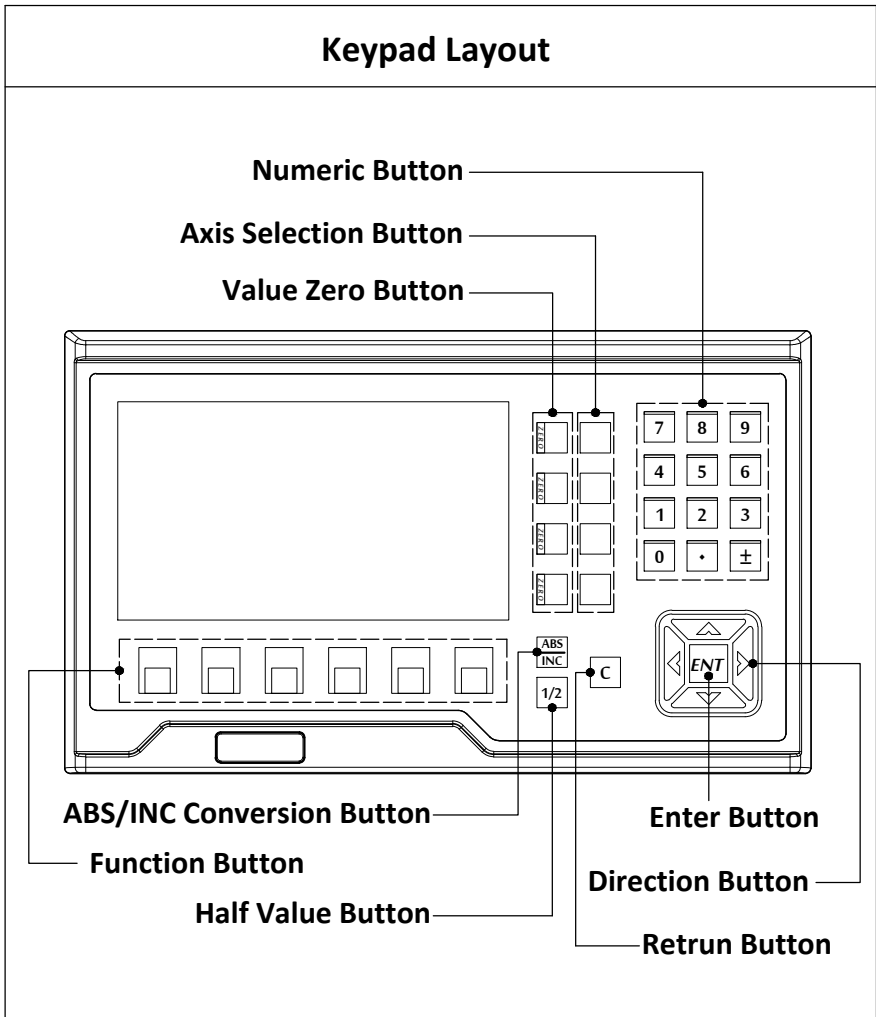

Content

1. System Parameter Setting

| | |
|-------------------------|----------|
| 1.1 DRO Setting | 1 |
| 1.2 Axis Setting | 1 |
| 1.3 Axis Summing | 3 |
| 1.4 Data Clear | 3 |
| 1.5 Keypad Test | 4 |
| 1.6 RPM Setting | 4 |

2. Fundamental Function

| | |
|---|-----------|
| 2.1 Zero, Value Recovery | 6 |
| 2.2 Imperial and Metric Conversion | 6 |
| 2.3 Coordinate Inputting | 6 |
| 2.4 1/2 Function | 6 |
| 2.5 ABS and INC Conversion | 6 |
| 2.6 Power-off Memory | 7 |
| 2.7 REF Function | 7 |
| 2.8 200 sets of SDM Coordinates | 9 |
| 2.9 Compensation Function | 10 |
| 2.10 Calculator | 14 |

Content

3. Special Function

| | |
|---|-----------|
| 3.1 Grid Hole Function | 15 |
| 3.2 Bolt Hole Function | 16 |
| 3.3 Simple R Function | 17 |
| 3.4 Smooth R Function | 18 |
| 3.5 Pocket Function | 19 |
| 3.6 Probe Measuring | 20 |
| 3.7 Radius and Diameter Conversion | 22 |
| 3.8 Vectoring Function | 23 |
| 3.9 Taper Measuring Function | 24 |
| 3.10 Tool Offsets Function | 24 |
| 3.11 EDM Function | 26 |
| 3.12 Distance to Go | 28 |
| 3.13 Signal Test Function | 29 |

4. Appendix

| | |
|----------------------------|-----------|
| 4.1 Parameter | 30 |
| 4.2 Dimension | 31 |
| 4.3 Troubleshooting | 32 |

1.1 DRO Setting

DRO setting includes: 1.Machine Type, 2.Number of Axis, 3.Decimal digits under inch mode, 4.Value Recovery, 5.Brightness,6.Background, 7.Dynamic Displaying, 8.Language, 9.Buzzer



1. Machine Type: Press set button to switch.(Milling,Lathe,Grinder,EDM)
2. Number of Axis: Press set button to set the number of axis to be displayed.
3. Decimal Digits: Press set button to set the decimal digits under inch mode.
4. Value Recovery: Press set button to enable or disable value recovery.
5. Brightness: Press set button to adjust the brightness of the screen.
6. Background: Press set button to switch background.(Day or Night)
7. Buzzer: Press set button to enable or disable the buzzer.
8. Dynamic Display: Press set button to switch the dynamic displaying.(Dynamic zoom,Dynamic Color or OFF)
9. Language: Press set button to switch the language.

Note:Dynamic zoom is only available on 1,2 and 3 axis with the condition the value is within the range.If the displaying value exceeded the range, the dynamic zoom will be switched to dynamic color.

1.2 Axis Setting

Axis setting includes: 1. Axis Selection, 2.Encoder Selection, 3.Resolution Setting, 4.Direction Setting, 5.Thread Pitch, 6.Decimal Digits, 7.Port Mapping

System Parameter Setting



1. Axis Selection: Press set button to switch the axis which shall be set.
2. Encoder Selection(Press set button to switch the encoder type for the corresponding axis.)
 - (1) Linear Scale:Connect linear scale to measure the linear length.
 - (2) 1-Rotary Encod:Connect with rotary encoder to measure the degree,displaying as degree.
 - (3) 2-Rotary Encod:Connect with rotary encoder to measure the degree,displaying as degree/minute/second
 - (4) 3-Rotary Encod:Connect with rotary encoder,basing the thread pitch,to measure the linear length.
3. Resolution Setting
 - (1) When the encoder type has been set as linear scale.Here we could switch the resolution to the target one.
(Range:0.1,0.2,0.5,1.0,2.0,2.5,5.0,10,20,25,50,100 μ m)
 - (2) When the encoder type has been set as 1-Rotary Encod,2-Rotary Encod,3-Rotary Encod,press numerical button or set button to input the corresponding resolution.
4. Direction Setting: Press set button to set.
(0 indicates positive direction,1 indicates negative direction)
5. Decimal Digits: Press set button to set the decimal digits under metric mode.

6. Port Mapping: Press set button to change the value displaying on another axis(For example,when the encoder has been connected with X axis port,you could set here to display the value on Y axis).

1.3 Axis Summing

Axis summing includes: 1.Axis Selection, 2.Summing Selection, 3.Switch ON or OFF



1. Axis Selection: Press set button to switch the axis which shall be set.
2. Axis Summing: Press set button to select the axis which shall be summed.
3. Switch ON or OFF: Press set button to enable or disable.

1.4 Data Clear

Data clear includes: 1.SDM Clear, 2.Factory Reset

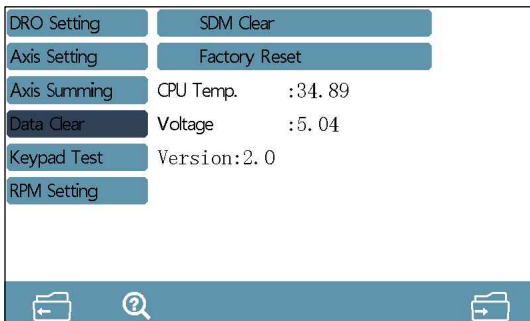

1. SDM Clear:Clear all memorized SDM coordinates.
2. Factory Reset:Clear all data memorized in DRO.

Operation: Select the item,and press the set button.The DRO will remind if it will carry out the data clear.Press YES,then it will go for data clear.Press NO,the DRO will quit clearing.

1.5 Keypad Test

Operation: Once enter this function.Press the mechanical button to test.If it works well,then the button on screen will change color.If it gets problem,the button on screen will remain without change.

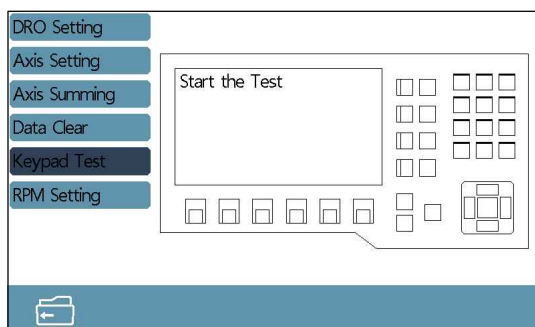

1.6 RPM Setting (Optional)

The sensor for the RPM could be hall sensor or rotary encoder.

RPM setting includes: 1.RPM Display, 2.Sensor Selection, 3.Setting for resolution of rotary encoder or number of magnets, 4.Teeth Number of Master Gear, 5.Teeth Number of Pinion

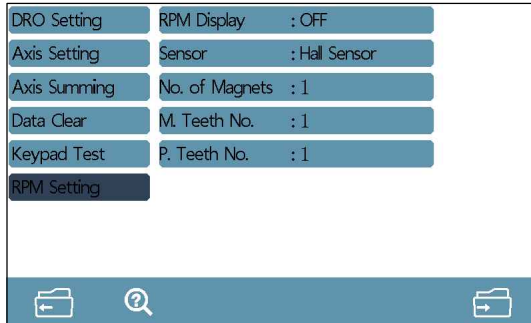

1. RPM Display: Press set button to enable or disable the RPM displaying.
2. Sensor Selection: Press set button to switch the sensor.(Hall Sensor or Rotary Encoder)

When the sensor has been set as rotary encoder,press numeric or set button to input the resolution.When the sensor has been set as hall sensor,press numeric to input the number of magnets.

3. Teeth Number of Master Gear: Press numeric to input the gear number.
4. Teeth Number of Pinion: Press numeric to input the gear number.

2.1 Zero, Value Recovery

1. Zero

Pressing the zero button, operator could zero the value on windows.

2. Value Recovery

When the value displayed on windows has been zeroed wrongly, press zero button again could get back the former value.

Note: When the zero function has been switched off in DRO Setting, the value could not be get back.

2.2 Imperial and Metric Conversion

Press the **MM/INCH** button to switch the displaying under imperial or metric unit.

2.3 Coordinate Inputting

Press the axis button, and press the numeric button to input the value. Once input, press **ENT** to confirm.

2.4 1/2 Function

Press the axis button and **1/2** button to half the value for corresponding axis.

2.5 ABS and INC Conversion

The DRO gets two sets of standard coordinate system, namely ABS (Absolute) and INC (Relative) Coordinate. User could set the zero point of work-piece in ABS coordinate, then switch to INC coordinate for machining. Zeroing at any position in INC coordinate would not affect the length value from zero point to current point in ABS coordinate. The process in ABS would change according to the machining status. User could switch the coordinate back to ABS for checking. Press ABS/INC button to switch.

2.6 Power-off Memory

In case of sudden power off during the machining process, the DRO gets the data memorize function. Once the power on, the data before power off will recover automatically.

2.7 REF Function

In daily machining, operator may encounter power failure. If losing the zero point of the work-piece, we have to retrieve the zero point again. For the convenience to retrieve the zero point, the DRO could memorize the mechanical zero reference point of linear scale. This enable the users to retrieve the zero point of work-piece quickly.

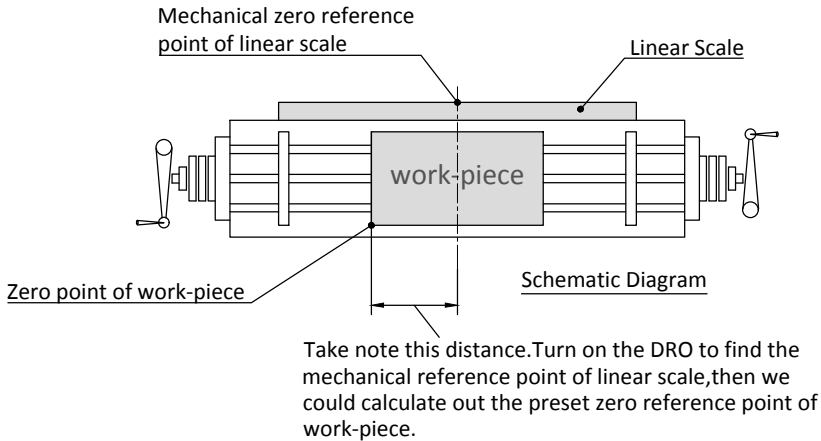

Note: To use the REF function, we need to set the mechanical zero reference point of linear scale in DRO. In this way, the DRO could memorize the zero point of work-piece. For the following zeroing, centre and value input for re-locate the zero point of work-piece under ABS model, the DRO will memorize the distance between new zero point of work-piece and mechanical zero reference point of linear scale. Once the mechanical reference point of linear scale has been set well, operator could retrieve the zero point of work-piece very quickly.

While DRO is powered on,press the REF function button.In the function interface,select the target item for parameter setting by pressing up and down direction button.

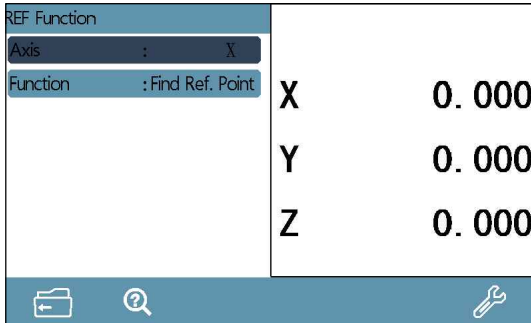

Axis: Press set button to select the corresponding axis for setting.

Function: press set button to switch the function to set the reference point or find reference point.

Set the Reference Point Steps:

Step 1: Press the set button to select the axis which shall be set.

Step 2: Press down direction button to switch to function setting,and press set button to set the function to find the reference point.Press **ENT** button to enter next interface,then traverse the linear scale to find the reference point.Once the point has been found,the DRO will remind with the messages of found the reference point.At this moment,the reference point setting of this axis is completed.

Retrieve the Zero Point of Work-piece:

Step 1: Take note of X,Y and Z axis under ABS model once the DRO self-checking process completed.

Step 2:Enter the REF function,select the axis which shall be set,then press down direction button for function setting.Set the function to find the reference point.Then press the ENT button to enter the finding interface.Traverse the linear scale.Once the reference point has been found.The DRO will remind with the message of found of reference point.

At this moment, the reference point of this axis has been found successfully.

Step 3: Traverse the linear scale of this axis to be the value which we took note. At this time, this point is the one we stopped for last machining.

Note: Only operator has set the reference point for each axis before machining, then the zero point of work-piece could be get back.

2.8 200 sets of SDM Coordinates

DRO provides ABS and INC coordinate. But sometimes it is not enough for daily machining. This DRO provides 200 groups of SDM auxiliary coordinate to compensate the shortage of ABS and INC function. But SDM is not just a simple additional INC coordinate. The below is the difference between ABS/INC and SDM.

- (1) INC is completely independent. No matter how zero point in ABS changed, the zero point in INC will not change. But the zero point of SDM is basing on ABS. When the zero point in ABS changed, all coordinate in SDM will change accordingly.
- (2) The distance between SDM and ABS coordinate could be input directly.

Applications for SDM Coordinates:

Operator could memorize the machining points of work-piece in SDM coordinates. Press up or down direction button to switch.

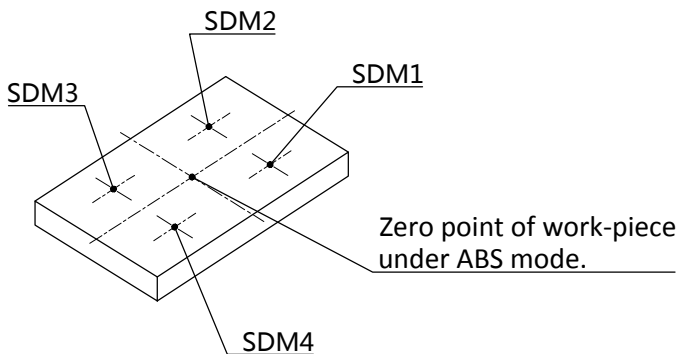

SDM application during medium or small batch machining:

SDM function could memorize a batch of working point. User could input these working points when machining the first work-piece. Then adjust the zero point in ABS mode for machining the following work-pieces. The SDM coordinate is basing the zero point in ABS mode.

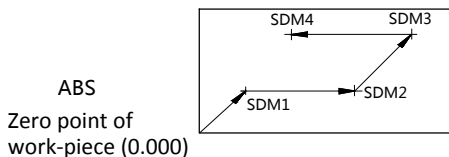

When the DRO is under SDM mode, press SDM button to input the SDM coordinate, or press up and down direction button to switch the coordinate. Traverse the linear scale until the value on each axis become 0. At this moment, this point is the machining point.

2.9 Compensation Function

Compensation function enable operator input the linear compensation, non-linear and backlash compensation value to improve the machining accuracy.

Press compensation function button to enter the interface. Press the up or down direction button to select the item for setting.

1. Linear Compensation

Axis: Select the axis for setting.

Comp. Type: Select the compensation type (Linear or Non-linear)

Backlash: Only the encoder type has been set as 3-Rotary Encod, there could be set.

Actual Length: Press numeric button to input the actual moving length of table. This length value is getting from more accurate measuring instrument than linear scale.

Comp. Value: Press numeric button to input the compensation value.

| Compensation Function | | | |
|-----------------------|----------|---|-------|
| Axis | : X | | |
| Comp. Type | : Linear | X | 0.000 |
| Backlash | : NA | | |
| Actual Length | : 0.000 | Y | 0.000 |
| Comp. Value | : 0.000 | Z | 0.000 |
| | | | |

Note: Formula for compensated value:

$$\text{Compensation Value} = (\text{Actual length} - \text{DRO Displayed length}) / (\text{Actual Length} / 1000) \text{mm/m}$$

Compensation range: -1.9mm/m to +1.9mm/m

Take X axis as an example (same operation to other axis)

Move the table of X axis direction for 1000.000mm of actual moving length. The displayed value on DRO is 999.880mm. The calculation of compensation value is like the below:

$$\text{Compensation Value} = (1000.000 - 999.880) / (1000.000 / 1000.000) = 0.120$$

Step 1: Confirm the starting point

Zero the value of X axis, press the COMP button to enter the function. Then set the axis to be X.

Step 2: Select the compensation type

Press down direction button to switch the compensation type setting and select it as Linear Compensation.

Step 3: Input the compensation value

Move the table of X axis direction to be exact 1000mm (based on other more accurate measuring instrument). Then press the up or down direction button to select the actual measuring length, and input 1000. Or select the compensation value to input 0.120.

Note:When selecting to input the actual measuring length.We need zero the value of corresponding axis first.Otherwise the compensation value will be calculated wrongly.

2. Non-linear compensation

Axis: Select the axis for setting.

Comp. Type: Select the compensation type(Linear or Non-linear)

Backlash: Only the encoder type has been set as 3-Rotary Encod,there could be set.

Comp. Segment: Press the numeric button to input the compensation segments.The maximum could be 100.

Comp. Length: Press numeric button to input the actual length of every segment.This length should be get from more accurate measuring instrument.

Start Point: Press set button to select the start point.(Endpoint or mechanical reference point of linear scale)

| Compensation Function | | | |
|-----------------------|--------------|---|-------|
| Axis | : X | | |
| Comp. Type | : Non-linear | X | 0.000 |
| Backlash | : NA | | |
| Comp. Segment | : 0 | Y | 0.000 |
| Comp. Length | : 0.000 | | |
| Start Point | : Endpoint | Z | 0.000 |

Non-linear compensation function takes the mechanical reference point or endpoint of linear scale as the starting point.The DRO will compensate the displayed value according the input err list.Please note Linear compensation and Non-linear compensation function could not be used at the same time.

The DRO gets two ways for non-linear compensation.

1. Take the linear scale end point as the starting point for compensation.

(Figure 1)

2. Take the first mechanical zero reference point of linear scale as the starting point for compensation.(Figure 2)

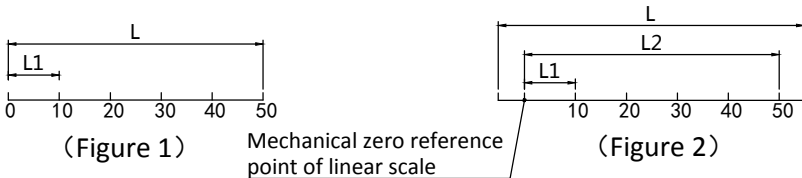

Take X axis setting as an example(same operation to other axis)

Step 1: Press the COMP. Button to enter the compensation function,and select the axis as X.

Step 2: Select the compensation type to be Non-linear.

Step 3: Input the the Compensation segments as 6.

Step 4: Input the compensation length for every segment as 10.000

Step 5: Select the starting point as the endpoint of linear scale.And press

ENT to go for next

Step 6: Move the table of X axis direction to one of the endpoint,and press **ENT** to confirm the point.(When the start point has been set as mechanical reference point of linear scale,once the point has been captured,the DRO will enter next step automatically).

Step 7: Using other more accurate measuring instruments as reference to move the table to be the value as input in compensation length which is 10.000,and press **ENT** to confirm.

Step 8: Repeat the operation of step 7 to complete all segments.Once the compensation finished,the DRO will exit compensation automatically.

Note:When the start point has been set as endpoint,the data in REF function will be cleared.Only the start point has been set as mechanical reference point,the REF and non-linear compensation could be used together.

3. Backlash Compensation

This setting could be set with the condition of encoder has been set 3-Rotary Encod.Press the numeric button to input the compensation value.

2.10 Calculator

Press the calculator button to enter the function.Once the calculation finished,operator could press axis button to transfer the value from calculator to axis.Press zero key,operator could transfer the value from axis to calculator.

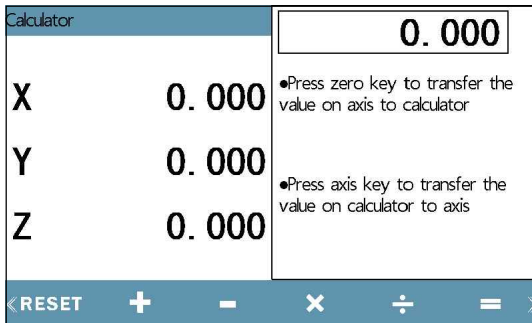

3.1 Grid Hole Function

This function is for drilling equal hole on vertical and horizontal direction. Once operator input the required parameter, the DRO will calculate the position of each hole, and set the coordinate of each hole to be (0.000,0.000). Operator could move the table to the target position for machining the hole.

There are two ways for grid hole function:

1. Length way: Input the total length of the line
2. Step way: Input the length between two holes

Press the grid hole function button to enter the interface. Press up and down direction button to select the parameter for setting.

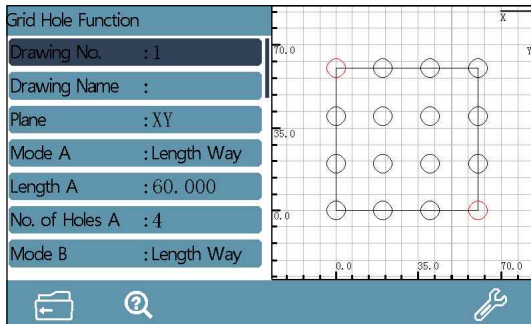

Drawing No.: DRO could memorize 4 sets of drawing. Press set button to switch.

Drawing Name: Press set button to input the drawing name. Press ENT to confirm.

Plane: Select the plane for machining. 2 axis DRO only gets XY plane. For DRO with 3 or more axis, it could be switch among XY, XZ, YZ.

Mode A: Press set button to set the mode to be Length or Step way for horizontal direction.

Length A: Press numeric button to input the length of horizontal direction.

No. Of Holes A: Press numeric button to input the hole number of horizontal direction.

Mode B: Press set button to set the mode to be Length or Step way for Vertical direction.

Length B: Press numeric button to input the length of Vertical direction.

No. Of Holes B: Press numeric button to input the hole number of Vertical direction.

Rotate Angle: Press numeric button to input the rotated angle of drawing.

Once the parameter has been set,press **ENT** to enter the machining interface.Press right or left button to switch the hole.

3.2 Bolt Hole Function

This function is for drilling equal hole on a circle.Once operator input the required parameter,the DRO will calculate the position of each hole,and set the coordinate of each hole to be (0.000,0.000).Operator could move the table to the target position for machining the hole.

There are 3 ways for bolt hole function.

1. 360°Equal:Drilling equal holes on a circle.
2. Equal Angle:Drilling holes with same angle between two holes.
3. Rand. Angle:Drilling equal holes on any random angle.

Press bolt hole function button to enter the interface.Press up and down direction button to select the parameter for setting.

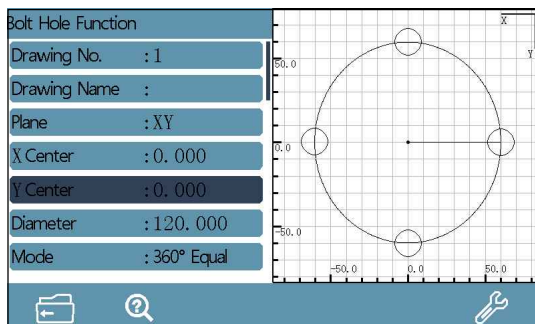

Drawing No.: DRO could memorize 4 sets of drawing.

Press set button to switch.

Drawing Name: Press set button to input the drawing name.

Press ENT to confirm.

Plane: Select the plane for machining. 2 axis DRO only gets XY plane.

For DRO with 3 or more axis, it could be switch among XY, XZ, YZ.

X Center: Press the numeric button to input the circle center of X axis.

Y Center: Press the numeric button to input the circle center of Y axis.

Diameter: Press numeric button to input the diameter.

Mode: Press set button to switch the machining mode among

360°Equal, Equal Angle and Rand. Angle.

Start Angle: Press numeric button to input the starting angle.

End Angle: Press numeric button to input the end angle.

No. Of Holes: Press numeric button to input the hole number.

Once the parameter has been set, press **ENT** to enter the machining interface. Press right or left button to switch the hole.

3.3 Simple R Function

This function is for machining 90° arc. Once operator input the required parameter, the DRO will calculate the position of each machining point, and set the coordinate of each machining point to be (0.000, 0.000).

Operator could move the table to the target position for machining the machining point.

Press Simple R function button to enter the interface. Press up and down direction button to select the parameter for setting.

Drawing No.: DRO could memorize 4 sets of drawing.

Press set button to switch.

Drawing Name: Press set button to input the drawing name.

Press ENT to confirm.

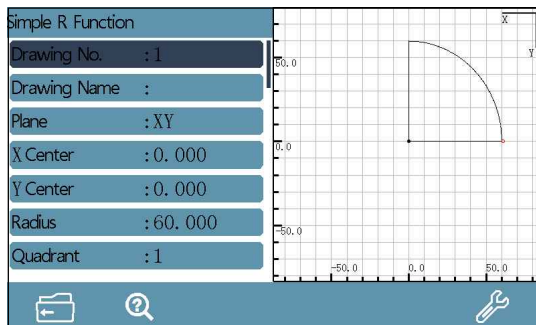

Plane: Select the plane for machining. 2 axis DRO only gets XY plane.

For DRO with 3 or more axis, it could be switch among XY, XZ, YZ.

X Center: Press the numeric button to input the circle center of X axis.

Y Center: Press the numeric button to input the circle center of Y axis.

Radius: Press numeric button to input the radius.

Quadrant: Press set button to set the quadrant which the arc will be machined.

Machining Edge: Press the set button to set the edge. When the plane is not in XY plane. The edge is determined by the set quadrant.

Direction: Press set button to set the machining direction.

Max-Cutting: Press numeric button to input the maximum cutting amount.

Tool Diameter: Press numeric button to input the tool diameter.

Once the parameter has been set, press **ENT** to enter the machining interface. Press right or left button to switch the machining point.

3.4 Smooth R Function

This function is for machining any angle arc. Once operator input the required parameter, the DRO will calculate the position of each machining point, and set the coordinate of each machining point to be (0.000, 0.000). Operator could move the table to the target position for machining the machining point.

Press Smooth R function button to enter the interface. Press up and down direction button to select the parameter for setting.

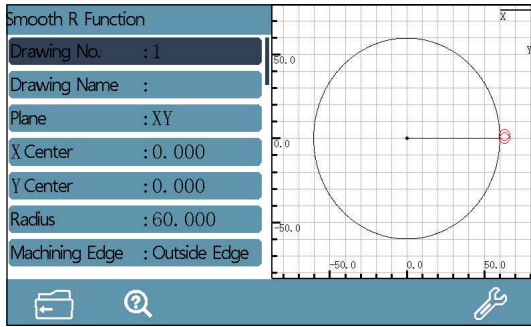

Drawing No.: DRO could memorize 4 sets of drawing.

Press set button to switch.

Drawing Name: Press set button to input the drawing name.

Press ENT to confirm.

Plane: Select the plane for machining.2 axis DRO only gets XY plane.

For DRO with 3 or more axis,it could be switch among XY,XZ,YZ.

X Center: Press the numeric button to input the circle center of X axis.

Y Center: Press the numeric button to input the circle center of Y axis.

Radius: Press numeric button to input the radius.

Machining Edge: Press the set button to set the edge.

Start Angle: Press numeric button to input the starting angle.

End Angle: Press numeric button to input the end angle.

Max-Cutting: Press numeric button to input the maximum cutting amount.

Tool Diameter: Press numeric button to input the tool diameter.

Once the parameter has been set,press **ENT** to enter the machining interface.Press right or left button to switch the machining point.

3.5 Pocket Function

This function is for machining rectangular.Once operator input the required parameter,the DRO will calculate the position of each machining point,and set the coordinate of each machining point to be (0.000,0.000).Operator could move the table to the target position for machining the machining point.

Press Pocket function button to enter the interface. Press up and down direction button to select the parameter for setting.

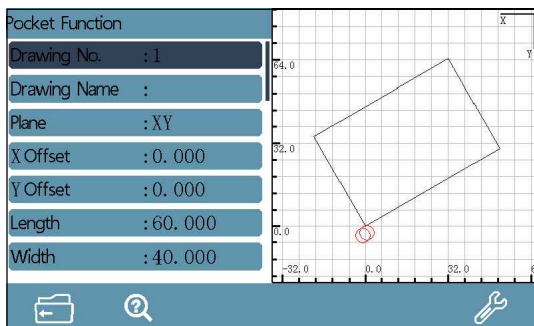

Drawing No.: DRO could memorize 4 sets of drawing. Press set button to switch.

Drawing Name: Press set button to input the drawing name.

Press ENT to confirm.

Plane: Select the plane for machining. 2 axis DRO only gets XY plane.

For DRO with 3 or more axis, it could be switch among XY, XZ, YZ.

X Offset: Press numeric button to input the value of X axis. This value is basing the zero point of work-piece.

Y Offset: Press numeric button to input the value of Y axis. This value is basing the zero point of work-piece.

Length: Press numeric button to input the length of rectangle.

Width: Press numeric button to input the width of rectangle.

Machining Edge: Press the set button to set the edge.

Rotate Angle: Press numeric button to input the rotated angle of drawing.

Once the parameter has been set, press **ENT** to enter the machining interface. Press right or left button to switch the machining point.

3.6 Probe Measuring

This function is for measuring the work-piece during or after machining.

There are two modes for measuring.

1. NO Probe: Take other tools like end mill or edge finder to locate the coordinate manually.
2. With Probe: Connect with 3D touch probe to locate the coordinate automatically.(Optional)

This function provides 3 measuring method to get different measuring value.

1. Projected Length Measuring: To measure the projected length for each axis.
2. Intersection Angle Measuring: To measure the intersection angle of two lines.
3. Circle Measuring: To measure the center, radius, diameter of a circle.

Press Probe Measuring function button to enter the interface.

Press up and down direction button to select the parameter for setting.

| | | | | |
|--------------------------------|---------------------------|---|--|-------|
| With Probe Mode | Probe Measuring | | | |
| | Measure Mode : With Probe | | | |
| | Probe : 0 | X | | 0.000 |
| | Probe Diameter : 0.000 | Y | | 0.000 |
| | Deflect Comp. : 0.000 | Z | | 0.000 |
| | | | | |
| NO Probe Mode | Probe Measuring | | | |
| | Measure Mode : NO Probe | | | |
| | Probe Diameter : 0.000 | X | | 0.000 |
| | | Y | | 0.000 |
| | | Z | | 0.000 |
| | | | | |

Measuring Mode: Press set button to set the mode.(Only the DRO gets the With Probe mode,this item could be set)

When the mode set as NO Probe.

Probe Diameter: Press the numeric button to input the diameter of end mill or edge finder.

When the mode set as With Probe.

Probe: Press the numeric button to select the probe.

Probe Diameter: Press numeric button to input the diameter.

Deflect Comp.: Press numeric button to input the deflection compensation value.

Once the parameter set well,press the measuring method button to enter the measuring interface.

When the mode set as NO Probe,operator could move the table to locate the coordinate manually,and then press ENT to confirm every point.

When the mode set as With Probe,operator could move the table,once the 3D touch probe come in contact with the work-piece.The DRO will locate the coordinate automatically.Operator could press ENT to confirm this point or press C to cancel this point.

Once the required point has been all captured,the DRO will calculate the value automatically.

3.7 Radius and Diameter Conversion

This function enable operator switch between radius and diameter when the DRO has been set lathe mode.

Press the radius and diameter conversion button to switch.Once the diameter activated ,the X axis will display a icon of diameter.

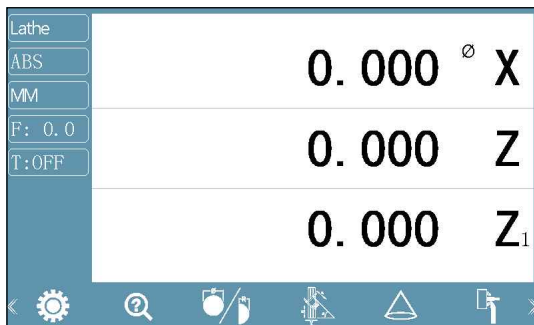

3.8 Vectoring Function

This function is for turning taper. Once operator input the required parameter, the DRO will calculate the position of each machining point, and set the coordinate of each machining point to be (0.000,0.000). Operator could move the table to the target position for machining the machining point.

Press vectoring function button to enter the interface. Press up and down direction button to select the parameter for setting.

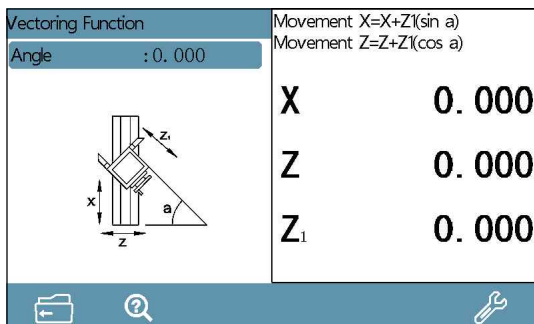

Angle: Press the numeric button to input the angle.

Once the angle has been input, move the table of Z1 direction.

The DRO will calculate the movement value of X and Z axis.

Movement $X=X+Z1(\sin\alpha)$

Movement $Z=Z+Z1(\cos\alpha)$

3.9 Taper Measuring Function

This function is for measuring the taper of work-piece. Press the taper measuring function button to enter.

Operation: Once the dial indicator set well. Move the table until the indicator come in contact with the surface of work-piece. Take note of the current value, and press ENT to confirm the current coordinate. Move the table again to locate another point until the value is same with the former one. Press ENT to confirm. At this moment, the DRO will calculate the taper and angle automatically.

3.10 Tool Offsets Function

This function is for memorizing the position of different tools.

Once the required parameter set well, the DRO will calculate and memorize the coordinate.

Switch the coordinate mode to be INC. Press the tool offsets function button. Press up and down direction button to select the parameter for setting.

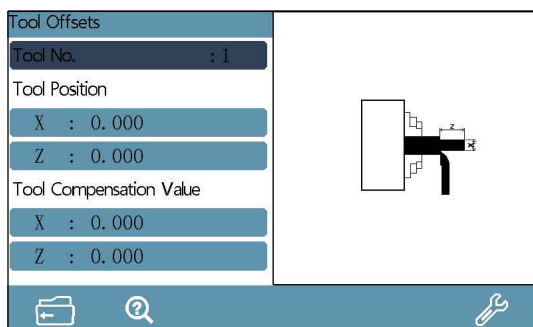

Tool No.: Press numeric button to switch the tool number.

(Maximum 16 sets)

Setting when the tool No. is OFF:

Base Tool: Press numeric button or right and left button to change the base tool. (Maximum 16 sets)

Setting when the tool No. is ON:

Tool Position

X: coordinate value for X axis

Z: coordinate value for Z axis

Tool Compensation Value

X: Compensation value for X axis

Z: Compensation value for Z axis

Select the item and press the numeric button to input the corresponding parameter.

Operation of tool clamping for the first time:

Clamp a tool and switch the coordinate system to be INC. Then start the machining. Once the machining completed, measure the length of X and Z axis direction. Then enter the tool offsets function and set this tool as No.1, input the length value into the tool position. At this time the first tool has been set. Same operation to the rest tool.

Operation for adding or changing a tool:

Switch the coordinate system to be INC and select a tool which has been set. Then enter the tool offsets function. Set the base tool and Tool No. to the current tool. Once set well, get back to INC interface to machine a end face of X axis and zero the value of Z axis. Then machine a certain length of Z axis and measure the length of X axis. Input the this length value into X axis. Switch the tool to be the one which will be added or changed, and start the machine again in X and Z axis. Once machined well, measure the length of X and Z axis. Then enter the tool offsets function, and select the tool No. which will be changed or added, input the value into X and Z axis which just measured.

3.11 EDM Function

This function is for EDM machining. When current value is equal to the preset value, the DRO will output a on/off signal to stop the EDM machining. The direction of Z axis is set as downward. (i.e. the depth is larger, and the value on Z axis will be larger.) The DRO also gets fire prevention for reverse height. This is an intelligent position following function for safety. Once the electrode exceeds the liquid level, the fire may be brought. This function will alarm and output a off signal for machining once the electrode exceeds the liquid level.

Press EDM function button to enter the interface. Press up and down direction button to select the parameter for setting.

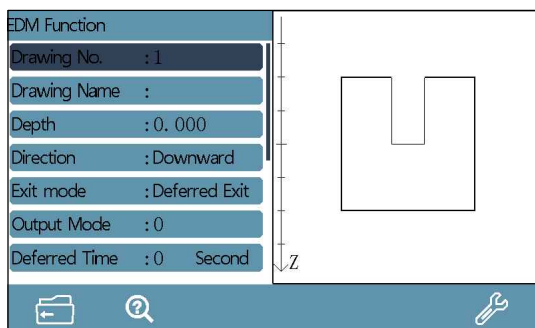

Drawing No.: DRO could memorize 4 sets of drawing.

Press set button to switch.

Drawing Name: Press set button to input the drawing name.

Press ENT to confirm.

Depth: Press numeric button to input the depth.

Direction: Press set button to set the direction

1. Downward: the machining direction is downward.
2. Upward: the machining direction is upward.

Exit Mode: Press set button to set.

1. Deferred Exit: Once the machining completed, the machining will exit according to the deferred time which has been set.
2. Manual Exit: Once the machining completed, the machining will exit manually by operator.

Output Mode: Press set button to set the mode. (0 or 1)

Mode 0:

- a. When power off, the relay coil is OFF.
- b. When the CPU is not initialized, the relay coil is OFF
- c. When output 1 under normal status after the DRO power on, the relay coil is ON
- d. When output 1 once the EDM function has been activated, the relay coil is ON.
- e. When output 0 once the target height has been reached, the relay coil is OFF.

Mode 1:

- a. When power off, the relay coil is OFF.
- b. When the CPU is not initialized, the relay coil is OFF
- c. When output 0 under normal status after the DRO power on, the relay coil is OFF.
- d. When output 1 once the EDM function has been activated, the relay coil is ON.
- e. When output 0 once the target height has been reached, the relay coil is OFF.

Deferred Time: Press numeric button to set the time. This only could be set when the exit mode has been set as deferred exit.

Oil Height: Press numeric button to set the height. Once the electrode exceed the oil height, the machining will be stopped. Once the parameter has been set, press **ENT** to enter the machining interface. Press right or left button to switch the hole.

3.12 Distance to Go

When the DRO is under INC mode, it provides a dynamic graphic for displaying the current position of tool. The small square in the scale which is under the window's value represents the tool. This function could help the operator locate the tool once the requested parameter has been set well.

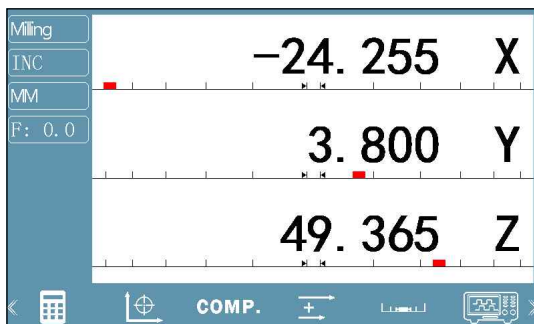

| Distance to Go | |
|----------------|---------|
| Axis | : X |
| Function | : ON |
| Pitch Length | : 5.000 |
| X | -24.255 |
| Y | 3.800 |
| Z | 49.365 |

Axis: Press set button to select the axis for setting.

Function: Press set button to switch ON or OFF for this axis.

Pitch Length: Press the numeric button to input the pitch length.

Note: 1. This function is only available when the axis is displaying the linear length, could not be used for angle measuring.
2. This function is not available for 5 axis displaying.

3.13 Signal Test Function

This function is for checking the signal of linear scale. Once operator connect the linear scale to X or Y port and set the corresponding parameter, then the oscillogram, duty ratio, phase difference could be tested.

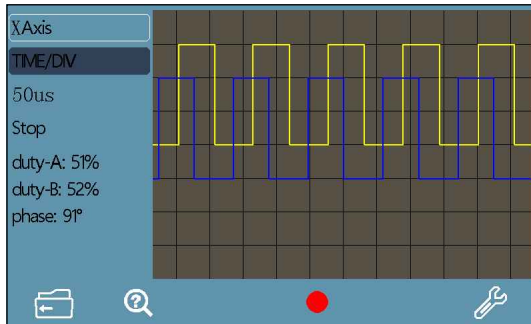

Axis: Press set button to switch X or Y port for checking.

Time/DIV: Press set button to set the time for every cell.

Press the green light button to run or stop.

Note: Once this function is activated, the current value and non-linear compensation data of the axis which is used as the checking port will lose. To prevent the data losing, please set the mechanical reference point first (refer the REF Function). If the reference has been set, operator could enter this function directly, once exit this function, traverse the linear scale, the DRO will search the mechanical reference point, and the value could be recovered automatically once the reference point has been captured.

4.1 Parameter

1. Voltage: AC 80V--260V ; 50-60HZ
2. Power: 15W
3. Displaying: 7" true color LCD screen
4. Working Temperature: -10°C--60°C
5. Storage Temperature: -30°C--70°C
6. Relative Humidity: <90% (25) >
7. Axis Number: 1 axis,2 axis,3 axis,4 axis,5 axis
8. Input Signal: 5V TTL/5V RS422
9. Input signal Frequency: <50MHZ
10. Resolution (Linear Encoder): 0.1 um , 0.2 um , 0.5 um , 1 um , 2 um , 2.5 um , 5 um , 10 um , 20 um , 25 um , 50 um , 100 um
11. Highest Resolution(Rotary Encoder): <1000000ppr
12. Weight: 1.5KGS
13. Dimension: 295*175*65mm
14. DB9 Pin diagram

DB9-5V TTL

| | | | | | | | | | |
|--------|-------|-------|-------|-----------|-------|--------|------|-------|-------|
| Pin | 1 | 2 | 3 | 4 | 5 | 6 | 7 | 8 | 9 |
| Signal | Empty | 0 V | Empty | Shield | Empty | A | +5 V | B | R |
| Color | | Black | | Shielding | | Yellow | Red | Green | Brown |

DB9-5V RS422

| | | | | | | | | | |
|--------|--------|-------|------|-----------|-------|--------|------|-------|-------|
| Pin | 1 | 2 | 3 | 4 | 5 | 6 | 7 | 8 | 9 |
| Signal | A- | 0 V | B- | Shield | Z- | A | +5 V | B | R |
| Color | Orange | Black | Blue | Shielding | White | Yellow | Red | Green | Brown |

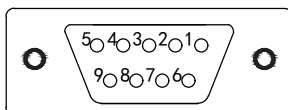

4.2 Dimension

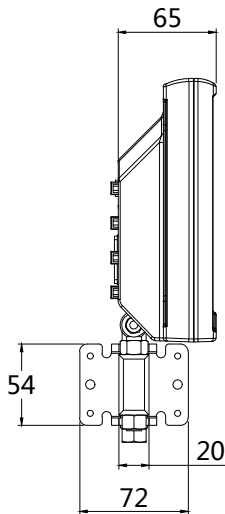
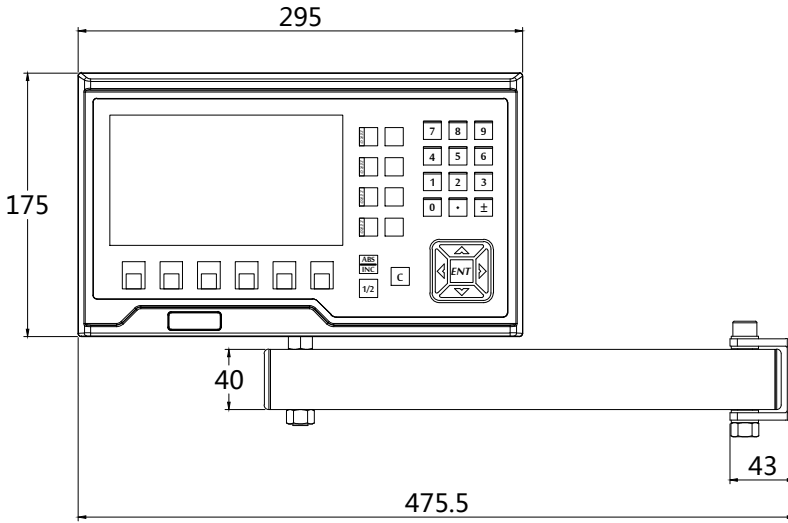

4.3 Troubleshooting

The following troubleshootings are just the preliminary methods. If the problems still exist, please do not dismantle the DRO by yourself, but contact our company or the dealers for help in time.

| Faults | Fault Causes | Solutions |
|---|--|---|
| The DRO doesn't display anything | <ol style="list-style-type: none"> 1. The power is not on ? 2. The power switch is not closed ? 3. The supply voltage is not appropriate 4. The internal supply of the grating ruler is in short circuit. | <ol style="list-style-type: none"> 1. Check whether the power line and power plug are plugged in. 2. Close the power switch. 3. Make sure the supply voltage between 80V-260V. 4. Pull out the connector of the grating ruler. |
| One axis of the DRO doesn't count | <ol style="list-style-type: none"> 1. Operate the machine after swapping with the grating ruler of another axis. 2. Some special functions of the DRO are being used. | <ol style="list-style-type: none"> 1. If counting, it's the fault of the grating ruler; if not, it's the fault of the DRO. 2. Exit the special function |
| The counting of DRO is not accurate (it can't zero) | <ol style="list-style-type: none"> 1. The grating ruler isn't installed according to the requirements or the accuracy is not enough. 2. After being used for a long time, the vibration of the machine tool makes the fixed reading head or the screws loosen. 3. The accuracy of the machine tool is not good. 4. The DRO resolution isn't consistent with the grating ruler. | <ol style="list-style-type: none"> 1. Reinstall the grating ruler and adjust the level. 2. Tighten all the fixed screws. 3. Overhaul the machine tool. 4. Reset the DRO resolution. |
| The counting of DRO is in error, The displayed operation distance isn't consistent with the actual distance | <ol style="list-style-type: none"> 1. The machine tool and the DRO shell are not connected to earth. 2. The accuracy of the machine tool is not good. 3. The running speed of the machine tool is too fast. 4. The grating ruler isn't installed according to the requirements and the accuracy is not enough. 5. The DRO resolution isn't consistent with the grating ruler. 6. The operating size unit is not consistent with the displayed Metric/British units. 7. The linear error compensation setting of the DRO is not appropriate. 8. The grating ruler exceeds the operating range of length or the read head is broken. | <ol style="list-style-type: none"> 1. Connect the machine tool and the DRO shell to earth. 2. Overhaul the machine tool. 3. Reduce the running speed of the machine tool. 4. Reinstall the grating ruler and adjust the level. 5. Reset the DRO resolution. 6. Switch the displayed Metric/British units. 7. Reset the linear error compensation of the DRO. 8. Repair the grating ruler. |

| Faults | Fault Causes | Solutions |
|--|--|--|
| <p>The grating ruler doesn't count</p> | <ol style="list-style-type: none"> 1. The grating ruler exceeds the operating range of length or the read head is broken. 2. The read head of grating ruler rubs the ruler shell leading to the aluminum scraps accumulated. 3. The gap between the read head of grating ruler and the ruler body is too wide. 4. The metal tubes of the grating ruler are damaged, which causing the short circuit or disconnection in internal wiring. | <ol style="list-style-type: none"> 1. Repair the grating ruler 2. Repair the grating ruler 3. Repair the grating ruler 4. Repair the grating ruler |
| <p>The grating ruler doesn't count sometimes</p> | <ol style="list-style-type: none"> 1. The small box of the grating ruler is separated from the steel ball. 2. The grating glass in the read head of the grating ruler is abraded. 3. There is dirt on the grating glass in the shell of the grating ruler. 4. The elasticity of small box spring in the read head of the grating ruler is not enough. | <ol style="list-style-type: none"> 1. Repair the grating ruler 2. Repair the grating ruler 3. Repair the grating ruler 4. Repair the grating ruler |

Driven by Innovation

DIGITAL READOUTS

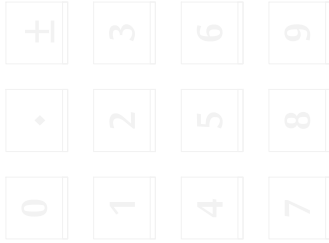

Operation Manual
(Version 2.0)