



HSD7

High performance servo system

Contents

Feature

HSD7-E Series Servopacks for Model Designations

HSD7-B Series Servopacks for Model Designations

Specifications for Servopacks

External Dimensions for Servopacks

HSM-F series high performance servomotor model designation

HSM-F series general servomotor model designation

Features

► Adjustment-free function

- With the adjustment-free function, one-key automatic tuning, to achieve fast and stable operation.
- No need to be proficient in servo debugging principle, debugging is easier.
- Even if the load changes during operation, the equipment can operate stably.

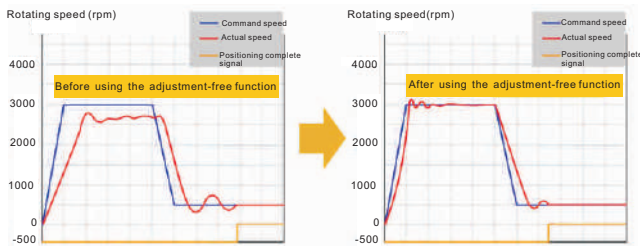

► Self-tuning function

- Based on the algorithm of servo auto-tuning, real-time automatic identification of load inertia changes, automatic adjustment of gain parameters, automatic setting of vibration suppression and notch frequency.
- Through automatic parameter adjustment, the debugging cycle is greatly shortened, system response performance is improved, and equipment production efficiency is improved.

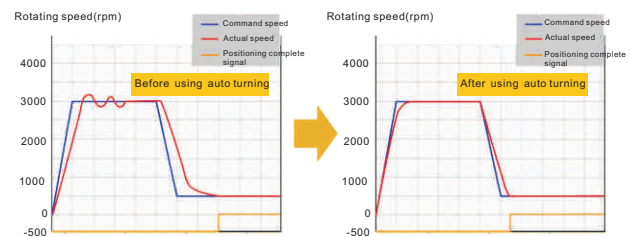

► Speed response is greatly improved

- Optimization based on higher hardware performance and control algorithm
- The speed response frequency of HSD7 series products is increased to 3.1KHz
- Significantly improve product response performance.

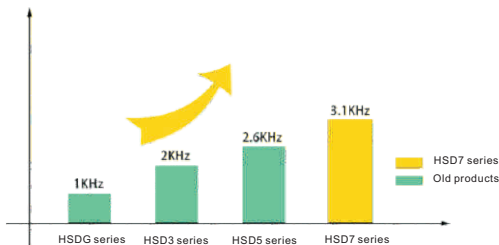

► Support multiple encoder types

- Support multiple types of encoders.
- HSD7 series products support up to 24bit high-resolution encoders.
- The single-turn resolution of the encoder is 16777216 p/r.
- The encoder has higher resolution, accuracy and more precise positioning.
- Low speed performance is more stable

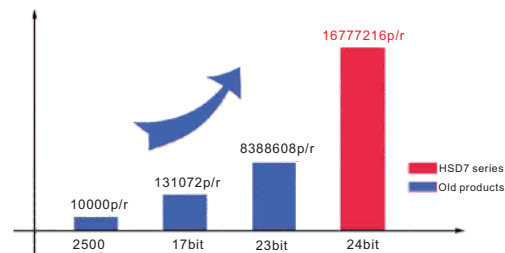

► Friction&backlash compensation

- Turn on the compensation function
- Effectively reduce commutation deviation and improve machining accuracy.
- Improve the stability when running at low speeds

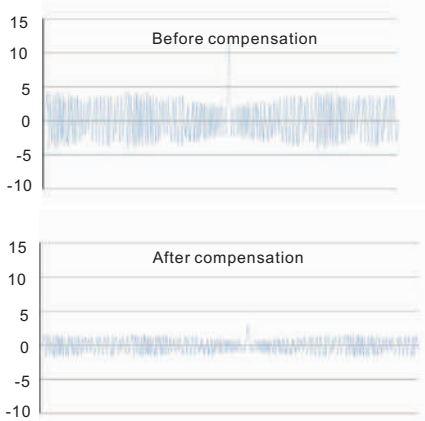

► Dynamic braking function

- Dynamic braking is to short-circuit the three-phase electrodes in an emergency, and stop at the fastest speed, thereby protecting the safety of people and equipment.

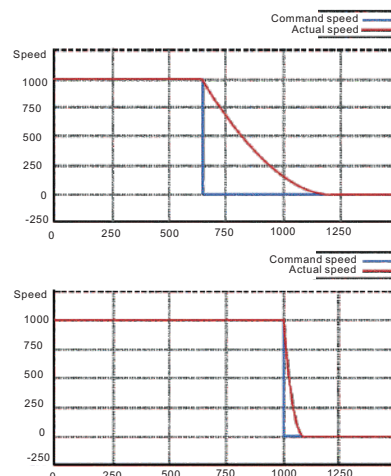

High performance servo system

Features

► Vibration suppression function

- Built-in 5 notch filters, Effectively suppress mechanical resonance.
- Suppress high frequency vibration above 500Hz.
- Strengthen the end vibration suppression function, effectively suppress the machine end vibration.
- Suppress low frequency vibration of 0.5-300Hz.

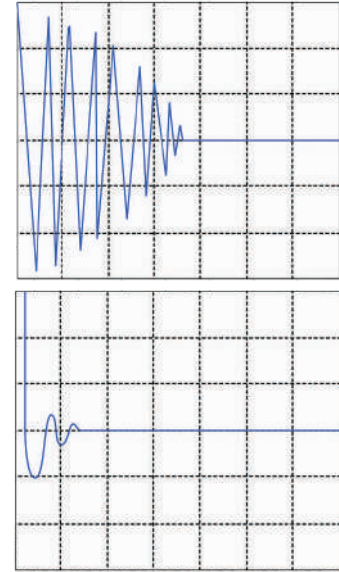
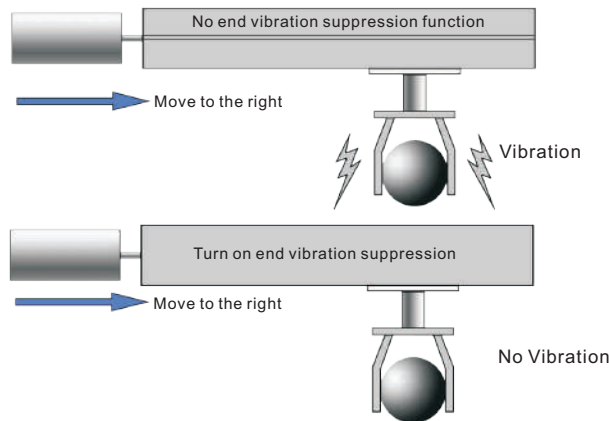
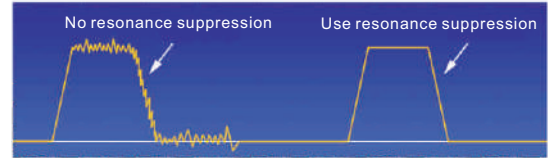

► Safe stop function (STO)

- Support STO (Safe Torque Off) function. It is ensured that after starting the STO function, the servo system will stop quickly under the condition of uninterrupted power supply to ensure the safety of people and equipment.

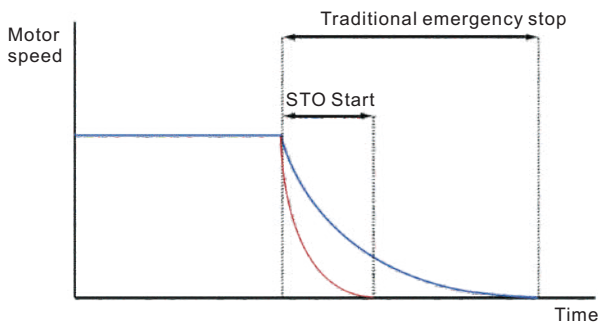

► High performance full closed loop control

- Full closed-loop control can be connected to an external grating ruler or encoder, and realize high-precision position control by reading the position feedback signal of the terminal.

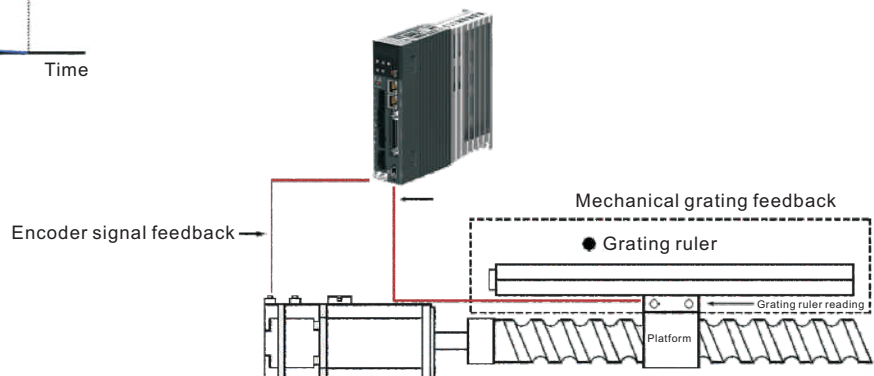

High Performance Servopack

HSD7-E Series servo drive Model Designation

HSD7		ES		10		A		00	
HSD7 Series Servopack		Axis Number		Continuous Output Current		Power Supply Voltage		Interface Type	
Axis Number		Continuous Output Current		Power Supply Voltage		InterfaceType			
S	Single Axis	03	3 A	A	220VAC	00	Pulse/Analog with standard resolution(12bits)		
		06	6.1 A			01	CANopen Communications		
		08	8.5 A			05	Pulse/Analog with high resolution(16bits)		
W	Double Axis	10	10 A			10	MECHATROLINK-II Communications		
		12	12 A			20	MECHATROLINK-III Communications		
		16	16 A			30	EtherCAT Communications		
		25	25 A						

*The maximum continuous output current specification of the double-axis drive is 10A.

HSD7		ES		15		D		00	
HSD7Series Servopack		Axis Number		Continuous Output Current		Power Supply Voltage		Interface Type	
Axis Number		Continuous Output Current		Power Supply Voltage		InterfaceType			
S	Single Axis	15	15 A	D	380VAC	00	Pulse/Analog with standard resolution(12bits)		
		18	18 A			01	CANopen Communications		
		24	24 A			05	Pulse/Analog with high resolution(16bits)		
		35	35 A			10	MECHATROLINK-II Communications		
						20	MECHATROLINK-III Communications		
						30	EtherCAT Communications		

Ratings
Three-phase, 220VAC
HSD7-ES/EW-□□A□□

Model			03A□□	06A□	08A□□	10A□	12A□□	16A□	25A□□
Continuous Output Current			3	6.1	8.5	10	12	16	25
Instantaneous Max. Output Current			10.6	14.1	21.2	24.8	29.7	49.5	63.6
Main Circuit	Power Supply		AC220 V, -15% to +10%, 50 Hz / 60 Hz						
	Input Current		1.9(5.1)	1.7(4.2)	5.4(14.3)	6.3(16.8)	7.6	10.1	15.7
Control Power Supply			AC220 V, -15% to +10%, 50 Hz / 60 Hz						
Power Supply Capacity*			0.9(2.1)	1.7(4.2)	2.4(5.8)	2.8(6.8)	3.4	4.0	5.9
Regenerative Resistor	Built-In Regenerative Resistor	Resistance	—	40	20	20	20	12	20
		Capacity	—	80	80	80	80	150	120
	Minimum Allowable External Resistance		40	20	15	15	15	15	10
Overvoltage Category			III						

Three-phase, 380VAC
HSD7-ES/EW-□□D□□

Model			15D□□	18D□□	24D□□	35D□□
Continuous Output Current			15	18	24	35
Instantaneous Max. Output Current			35.4	49.5	63.6	99
Main Circuit	Power Supply		AC 380 V, -15% to +10%, 50 Hz / 60 Hz			
	Input Current		8.6	14.5	21.7	31.8
Control Power Supply			DC24V, -10% to +10% 50W			
Power Supply Capacity*			7.1	11.7	14.4	21.9
Regenerative Resistor	Built-In Regenerative Resistor	Resistance	32	32	—	—
		Capacity	150	150	—	—
	Minimum Allowable External Resistance		32	32	23	16
Overvoltage Category			III			

General Servopack

HSD7-B Series servo drive Model Designation

HSD7		-	BS		-	10		-	A		-	00	
HSD7 Series Servopack			Axis Number			Continuous Output Current			Power Supply Voltage			Interface Type	

Axis Number		Continuous Output Current		Power Supply Voltage		Interface Type	
S	Single Axis	03	3 A	A	220VAC	00	Pulse/Analog with standard resolution(12bits)
		06	6.1 A			01	CANopen Communications
W	Double Axis	08	8.5 A			05	Pulse/Analog with high resolution(16bits)
		10	10 A			30	EtherCAT Communications

Ratings

Three-phase, 220VAC

HSD7-BS/BW-□□A□□

Model	03A□□	06A□□	08A□□	10A□□		
Continuous Output Current	3	6.1	8.5	10		
Instantaneous Max. Output Current	10.6	14.1	21.2	24.8		
Main Circuit	Power Supply AC 220 V, -15% to +10%, 50 Hz / 60 Hz					
	Input Current		1.9(5.1)	4.3(10.3)	6.5(14.3)	8.2(16.8)
Control Power Supply		AC 220 V, -15% to +10%, 50 Hz / 60 Hz				
Power Supply Capacity*		0.9(2.1)	1.9(4.2)	2.9(5.8)	3.6(6.8)	
Regenerative Resistor	Built-In Regenerative Resistor	Resistance	—	40	20	12
		Capacity	—	80	80	150
	Minimum Allowable External Resistance		40	20	15	12
Overvoltage Category		III				

Specifications

Items		Specifications
Control Method		IGBT-based PWM control, sine wave current drive
Feedback		23bits or 24bits absolute encoder, for HSD7-E series 2500ppr incremental encoder, for HSD7-B series
Operating Conditions	Surrounding Air Temperature	0~+50°C
	Storage Temperature	-20~+85°C
	Surrounding Air Humidity	95% relative humidity max. (With no freezing or condensation)
	Storage Humidity	95% relative humidity max. (With no freezing or condensation)
	Vibration Resistance	4.9 m/s ²
	Shock Resistance	19.6 m/s ²
	Protection Class	IP20
	Pollution Degree	Must be no corrosive or flammable gases. Must be no exposure to water, oil, or chemicals. Must be no dust, salts, or iron dust.
	Altitude	1000 m or less
Others		Do not use SERVOPACKs in the following locations: Locations subject to static electricity noise, strong electromagnetic / magnetic fields, radioactivity
Applicable Standards		EN 50178, EN 61800-5-1, EN55011 group 1 class A, EN 61000-6-2, EN 61000-6-4, EN 61800-3, IEC 61508-1 to 4, IEC 61800-5-2, IEC 62061 and IEC 61326-3-1
Mousing		Standard: Base-mounted
Performance	Speed Control Range	1:5000 (The lower limit of the speed control range must be lower than the point at which the rated torque does not cause the servomotor to stop.)
	Coefficient of Speed Fluctuation	±0.01% of rated speed max. (for a load fluctuation of 0% to 100%)
		0% of rated speed max. (for a voltage fluctuation of ±10%)
		±0.1% of rated speed max. (for a temperature fluctuation of 25°C±25°C)
	Torque Control Tolerance (Repeatability)	1%
Soft Start Time Setting	0 to 10 s (can be set individually for acceleration and deceleration.)	
Displays / Indicators		CHARGE indicator and five-digit seven-segment display
Panel Operator		Five push switches

General Servopack

Specifications

Items		Specifications	
I/O Signal	Encoder Output Pulses	Phase A, phase B, phase C: line driver output; Number of divided output pulses: Any setting is allowed.	
	Sequence Input	Input Signals That Can Be Allocated	
		<p>Allowable voltage range: 24 VDC \pm20%</p> <p>Number of input points: 8</p> <p>Input method: Sink inputs or source inputs</p> <p>Input Signals:</p> <ul style="list-style-type: none"> Servo ON Proportional control Forward drive prohibit and reverse drive prohibit Alarm reset Forward external torque limit and reverse external torque limit Internal Settings Speed Switch Zero clamping Position deviation clearance Gain Selection <p>A signal can be allocated and the positive and negative logic can be changed.</p>	
I/O Signal	Sequence Output	Output Signals That Can Be Allocated	
		<p>Allowable voltage range: 5 VDC to 30 VDC</p> <p>Number of output points: 6</p> <p>Output Signals:</p> <ul style="list-style-type: none"> Positioning completion Speed limit detection Speed coincidence detection Brake Rotation detection Servo ready Torque limit detection Servo alarm <p>A signal can be allocated and the positive and negative logic can be changed.</p>	
Communications	RS-485 Communications	Communications Standard	MODBUS
		1:N Communications	Up to N = 50 stations possible for RS-485 port
		Axis Address Setting	Set with parameters

Specifications

Items			Specifications		
Control	Speed Control	Soft Start Time Setting		0 to 10 s (can be set individually for acceleration and deceleration.)	
		Input Signals	Reference Voltage	Max. input voltage: ± 10 V (forward speed reference with positive reference) 150(r/min)/V (default setting); Input gain setting can be changed.	
			Input Impedance	Approx. 20 K Ω	
			Circuit Time Constant	47 μ s	
		Internal Set Speed Control	Rotation Direction Selection	With Proportional Control signal	
			Speed Selection	With forward/reverse external torque limit signal (speed 1 to 3 selection). Servomotor stops or another control method is used when both are OFF.	
	Position Control	Feedforward Compensation		0 to 100%	
		Positioning Completed Width Setting		0 to 1,073,741,824 reference units	
		Input Signals	Reference pulses	Reference Pulse Form	One of the following is selected: Sign + pulse train、CW + CCW pulse train、or two-phase pulse train with 90°phase differential
				Input Form	Line driver or open collector
				Maximum Input Frequency	Sign + pulse train or CW + CCW pulse train: 500kpps Two-phase pulse train with 90°phase differential: 500kpps Sign + pulse train or CW + CCW pulse train: 200kpps Two-phase pulse train with 90°phase differential: 200kpps
		Clear Signal		Position deviation clear Line driver or open collector	
	Torque Control	Input Signals	Reference Voltage	Maximum input voltage: ± 10 V (forward torque output for positive reference). 3.3 VDC at rated torque (default setting); Input gain setting can be changed.	
			Input Impedance	Approx. 20 K Ω	
			Circuit Time Constant	47 μ s	
	Regenerative Processing			Built-in or external regenerative resistors (options)	
	Overtravelling (OT) Prevention			Dynamic brake stop at P-OT or N-OT, deceleration to a stop, or free run to a stop	
	Protective Functions			Overcurrent, Overvoltage, low voltage, overload, regeneration error , etc.	
Utility Functions			Gain adjustment, alarm history, JOG operation, etc.		

General Servopack

External Dimensions

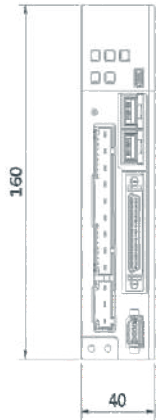

Unit : mm

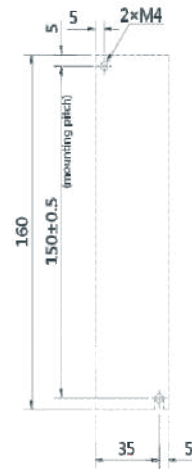
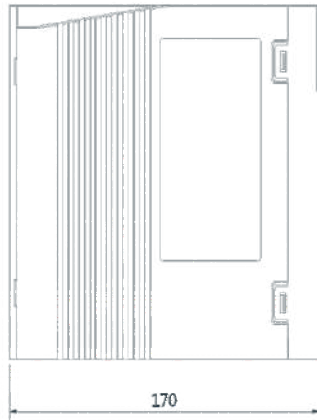

Mounting Hole Diagram

HSD7-ES-03A□□ **HSD7-BS-03A**□□

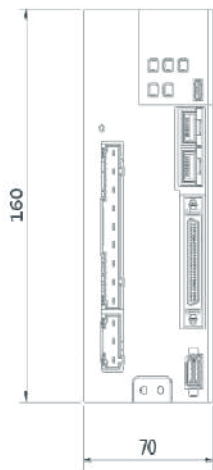

Unit : mm

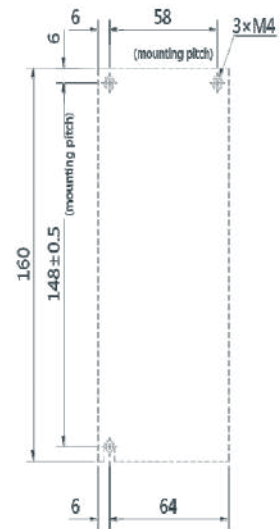
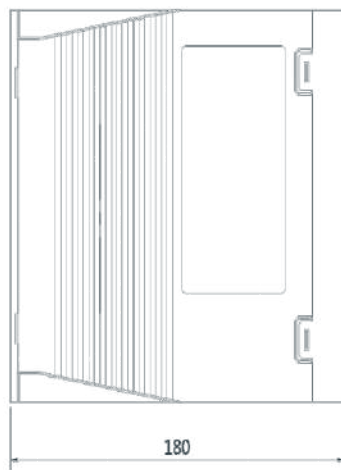

Mounting Hole Diagram

HSD7-ES-06A□□ **HSD7-BS-06/08/10A**□□

External Dimensions

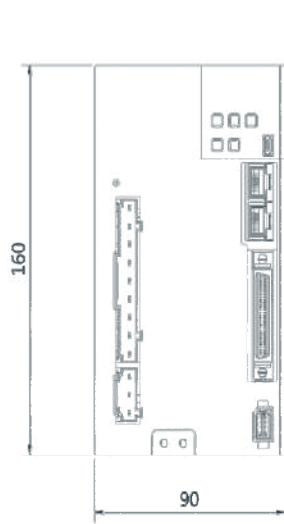

Unit : mm

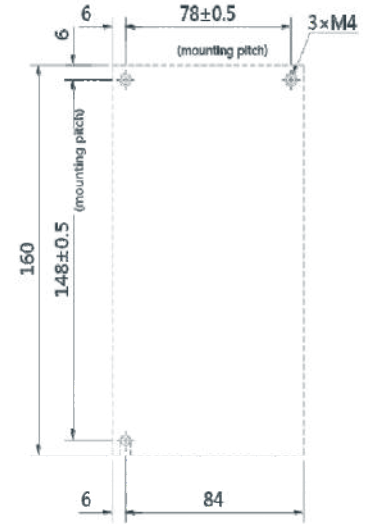
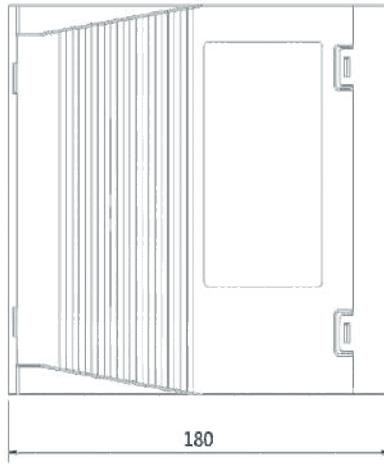

Mounting Hole Diagram

HSD7-ES-08/10/12A□□

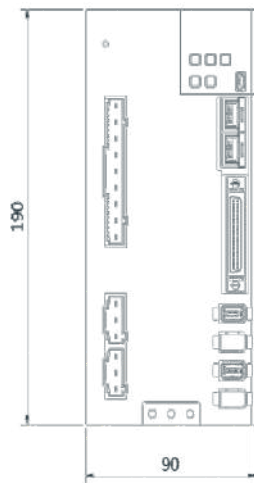

Unit : mm

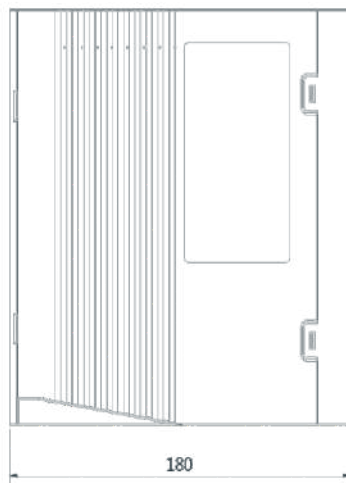

Mounting Hole Diagram

HSD7-EW-03/06/08/10A□□ **HSD7-BW-03/06/08/10A**□□

General Servopack

External Dimensions

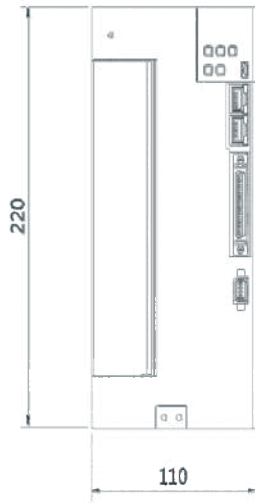

Unit : mm

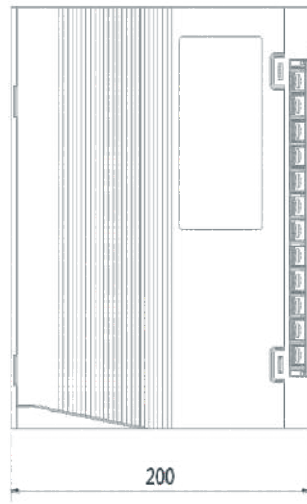

Mounting Hole Diagram

HSD7-ES-16/25A□□ **HSD7-ES-15/18D**□□

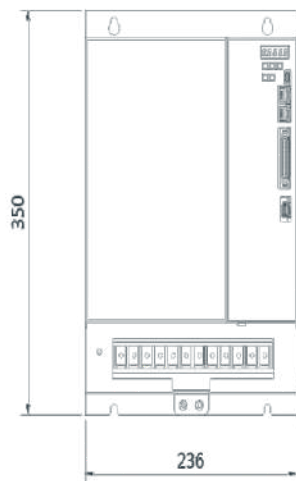

Unit : mm

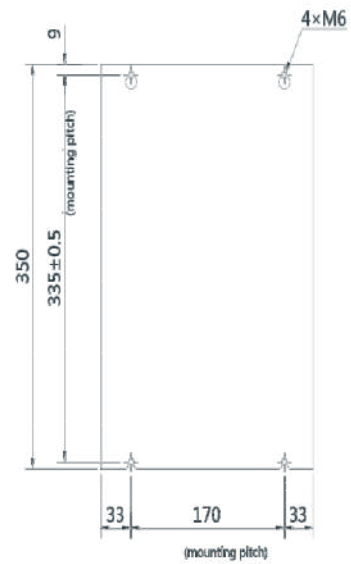

Mounting Hole Diagram

HSD7-ES-24/35D□□

Model Designation

SF **130** **-** **2** **-** **054** **M** **15** **30** **B** **-** **A**

SF Series Servo motor Flange Dim. Power Voltage Rated Torque Rated Speed Maximum Speed Brake Encoder type

Flange Dim.		Rated Torque		Rated /Max. Speed		Power Voltage		Brake		Encoder Type
40	40mm	003	0.32 N.m	15	1500 rpm	2	AC220V	B	With brake	A 23-bit absolute
60	60mm	006	0.64 N.m	20	2000 rpm	4	AC380V			
80	80mm	013	1.27 N.m	30	3000 rpm					
110	110mm	024	2.40 N.m	50	5000 rpm					
130	130mm	032	3.18 N.m	60	6000 rpm					
180	180mm	042	4.2 N.m							
		054	5.4 N.m							
		064	6.4 N.m							
		084	8.4 N.m							
		096	9.6 N.m							
		115	11.5 N.m							
		146	14.6 N.m							
		018	18.6 N.m							
		028	28.4 N.m							
		035	35 N.m							
		048	48 N.m							

Note:

AC220 and AC380 motors have different definitions of rated torque.

For example: AC220V motor, 146 represents 14.6N.m; AC380V motor, 018 represents 18.6N.m.

The last four torques 018, 028, 035, 048 correspond to AC380V motors.

High Performance Servo motors

Model List

Model	Rated Torque	Rated Speed	Max Speed	Rated Current	Rated Power	Driver Type
SF40-2-003M3060-A	0.32 Nm	3000 rpm	6000 rpm	1.1 A	100 W	HSD7-ES-03A□□
SF60-2-006M3060-A	0.64 Nm	3000 rpm	6000 rpm	1.6 A	200 W	
SF60-2-013M3060-A	1.27 Nm	3000 rpm	6000 rpm	2.9 A	400 W	
SF80-2-024M3050-A	2.40 Nm	3000 rpm	5000 rpm	4.6 A	750 W	HSD7-ES-06A□□
SF80-2-032M3050-A	3.18 Nm	3000 rpm	5000 rpm	6.1 A	1.0 Kw	
SF110-2-042M2030-A	4.2 Nm	2000 rpm	3000 rpm	4.5 A	0.88 KW	
SF110-2-054M2030-A	5.4 Nm	2000 rpm	3000 rpm	5.5 A	1.1 KW	HSD7-ES-08A□□
SF130-2-054M1530-A	5.4 Nm	1500 rpm	3000 rpm	6.5 A	0.85 KW	
SF130-2-064M1530-A	6.4 Nm	1500 rpm	3000 rpm	8.0 A	1.0 KW	
SF130-2-084M1530-A	8.4 Nm	1500 rpm	3000 rpm	9.5 A	1.3 KW	HSD7-ES-10A□□
SF130-2-096M1530-A	9.6 Nm	1500 rpm	3000 rpm	10.0 A	1.5 KW	
SF130-2-115M1520-A	11.5 Nm	1500 rpm	2000 rpm	9.0 A	1.8 KW	
SF130-2-146M1520-A	14.6 Nm	1500 rpm	2000 rpm	11.0 A	2.3 KW	HSD7-ES-12A□□
SF130-2-115M1530-A	11.5 Nm	1500 rpm	3000 rpm	14.0 A	1.8 KW	HSD7-ES-16A□□
SF130-2-146M1530-A	14.6 Nm	1500 rpm	3000 rpm	16.0A	2.3 KW	
SF180-4-018M1530-A	18.6 Nm	1500 rpm	3000 rpm	11.9 A	2.9 KW	HSD7-ES-15D□□
SF180-4-028M1530-A	28.4 Nm	1500 rpm	3000 rpm	16.5 A	4.4 KW	HSD7-ES-18D□□
SF180-4-035M1530-A	35 Nm	1500 rpm	3000 rpm	20.8 A	5.5 KW	HSD7-ES-24D□□
SF180-4-048M1530-A	48 Nm	1500 rpm	3000 rpm	25.7 A	7.5 KW	HSD7-ES-35D□□

Parameter and Dimensions

Model	SF40-2-003M3060-A	SF60-2-006M3060-A	SF60-2-013M3060-A	SF80-2-024M3060-A	SF80-2-032M3050-A
Rated Power	100 W	200 W	400 W	750 W	1.0 KW
Rated Torque	0.32 Nm	0.64 Nm	1.27 Nm	2.4 Nm	3.18 Nm
Rated Speed	3000 rpm	3000 rpm	3000 rpm	3000 rpm	3000 rpm
Maximum Speed	6000 rpm	6000 rpm	6000 rpm	5000 rpm	5000 rpm
Rated Current	1.1 A	1.6 A	2.9 A	4.8 A	6.1 A
Rotor Inertia	0.036Kgm ² ×10 ⁻⁴ (0.037Kgm ² ×10 ⁻⁴)	0.24 Kgm ² ×10 ⁻⁴ (0.25 Kgm ² ×10 ⁻⁴)	0.315 Kgm ² ×10 ⁻⁴ (0.325 Kgm ² ×10 ⁻⁴)	0.932 Kgm ² ×10 ⁻⁴ (0.998 Kgm ² ×10 ⁻⁴)	1.122 Kgm ² ×10 ⁻⁴ (1.188 Kgm ² ×10 ⁻⁴)
Maximum Current	3.3 A	4.9 A	8.8 A	15 A	19.2 A
Maximum Torque	0.96 Nm	2.24 Nm	3.9 Nm	7.2 Nm	9.54 Nm

Note: The inertia of the rotor with brake type is in the brackets.

40 frame motor installation size

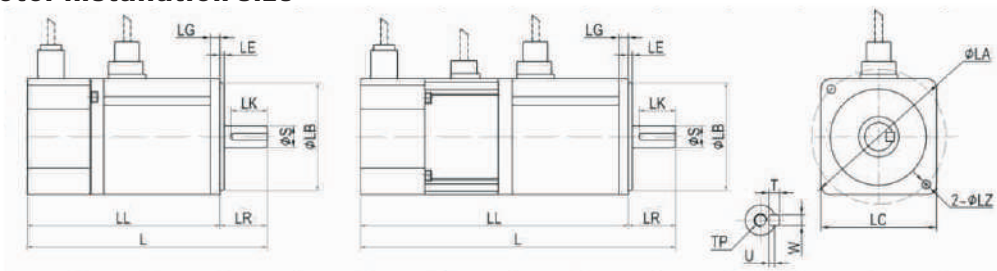

60/80 frame motor installation size

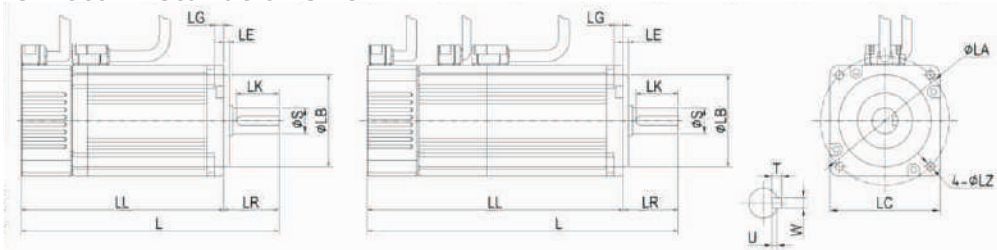

Model	L	LL	LR	LE	LG	LC	LA	LZ	S	LB	T	U	W	LK	TP
SF40-2-003M3060-A	111.5 (145)	86 (119.5)	25.5	3	5	40	46	4.5	8 ⁰ -0.013	30 ⁰ -0.03	3	1.8	3	14	M3*6
SF60-2-006M3060-A	122 (151)	92 (121)	30	3	9	60	70	5.5	14 ⁰ -0.013	50 ⁰ -0.03	5	3	5	25	-
SF60-2-013M3060-A	140 (169)	110 (139)	30	3	9	60	70	5.5	14 ⁰ -0.013	50 ⁰ -0.03	5	3	5	25	-
SF80-2-024M3050-A	165 (205)	125 (165)	40	3	9.5	80	90	6.5	19 ⁰ -0.013	70 ⁰ -0.03	6	3.5	6	25	-
SF80-2-032M3050-A	180 (220)	140 (180)	40	3	9.5	80	90	6.5	19 ⁰ -0.013	70 ⁰ -0.03	6	3.5	6	25	-

Note: The value in brackets is the length of the motor with brake.

High Performance Servo motors

Parameter and Dimensions

110 frame

Model	SF110-2-042M2030-A	SF110-2-054M2030-A
Rated Power	0.88 KW	1.1 KW
Rated Torque	4.2 Nm	5.4 Nm
Rated Speed	2000 rpm	2000 rpm
Maximum Speed	3000 rpm	3000 rpm
Rated Current	4.5 A	5.5 A
Rotor Inertia	7.87 Kg $m^2 \times 10^{-4}$ (8.51 Kg $m^2 \times 10^{-4}$)	9.16 Kg $m^2 \times 10^{-4}$ (9.80 Kg $m^2 \times 10^{-4}$)
Maximum Current	14.0A	17.5A
Maximum Torque	12.6 Nm	16.2 Nm

130frame

Model	SF130-2-054M1530-A	SF130-2-064M1530-A	SF130-2-084M1530-A	SF130-2-096M1530-A
Rated Power	0.85 KW	1.0 KW	1.3 KW	1.5 KW
Rated Torque	5.4 Nm	6.4 Nm	8.4 Nm	9.6 Nm
Rated Speed	1500 rpm	1500 rpm	1500 rpm	1500 rpm
Maximum Speed	3000 rpm	3000 rpm	3000 rpm	3000 rpm
Rated Current	6.5 A	8.0 A	9.5 A	10.0A
Rotor Inertia	13.88Kg $m^2 \times 10^{-4}$ (15.55Kg $m^2 \times 10^{-4}$)	16.04 Kg $m^2 \times 10^{-4}$ (17.71Kg $m^2 \times 10^{-4}$)	20.59Kg $m^2 \times 10^{-4}$ (22.26Kg $m^2 \times 10^{-4}$)	23.69 Kg $m^2 \times 10^{-4}$ (25.36Kg $m^2 \times 10^{-4}$)
Maximum Current	20.5A	25.2 A	30.0A	31.5 A
Maximum Torque	16.2 Nm	19.2 Nm	25.2 Nm	28.8 Nm

Model	SF130-2-115M1520-A	SF130-2-115M1530-A	SF130-2-146M1520-A	SF130-2-146M1530-A
Rated Power	1.8 KW		2.3 KW	
Rated Torque	11.5 Nm		14.6 Nm	
Rated Speed	1500 rpm		1500 rpm	
Maximum Speed	2000 rpm	3000 rpm	2000 rpm	3000 rpm
Rated Current	9.0 A	14.0 A	11.0 A	16.0A
Rotor Inertia	30.15Kg $m^2 \times 10^{-4}$ (31.82Kg $m^2 \times 10^{-4}$)		40.70 Kg $m^2 \times 10^{-4}$ (42.37Kg $m^2 \times 10^{-4}$)	
Maximum Current	28.4 A	44.1A	34.7 A	50.4A
Maximum Torque	34.5 Nm		43.8 Nm	

Note: The inertia of the rotor with brake type is in the brackets.

Parameter and Dimensions

Motor installation dimension drawing

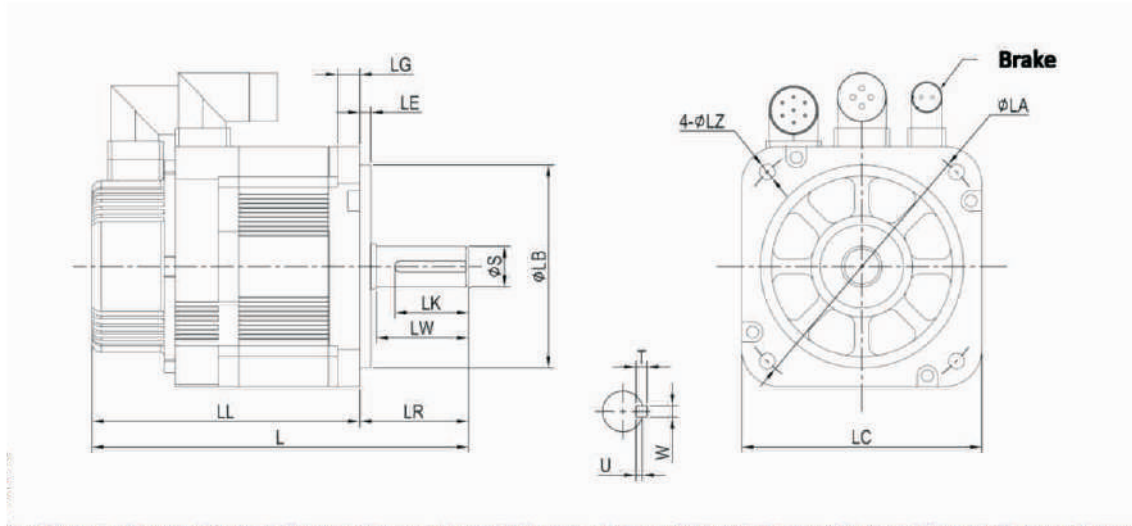

Model	L	LL	LR	LE	LG	LC	LA	LZ	S	LB	T	U	W	LK	TP
SF110-2-042M2030-A	209 (245)	153 (189)	56	5	12	110	130	9	$19^0_{-0.013}$	$95^0_{-0.04}$	6	3.5	6	40	48
SF110-2-054M2030-A	219 (255)	163 (199)	56	5	12	110	130	9	$19^0_{-0.013}$	$95^0_{-0.04}$	6	3.5	6	40	48

Note: The value in brackets is the length of the motor with brake.

Model	L	LL	LR	LE	LG	LC	LA	LZ	S	LB	T	U	W	LK	TP
SF130-2-054M1530-A	204 (231)	145 (172)	59	6	12	130	145	8.5	$22^0_{-0.013}$	$110^0_{-0.04}$	6	3.5	6	40	50
SF130-2-064M1530-A	211 (238)	152 (178)	59	6	12	130	145	8.5	$22^0_{-0.013}$	$110^0_{-0.04}$	6	3.5	6	40	50
SF130-2-084M1530-A	224 (251)	165 (192)	59	6	12	130	145	8.5	$22^0_{-0.013}$	$110^0_{-0.04}$	6	3.5	6	40	50
SF130-2-096M1530-A	232 (259)	173 (200)	59	6	12	130	145	8.5	$22^0_{-0.013}$	$110^0_{-0.04}$	6	3.5	6	40	50
SF130-2-115M1520-A	251 (278)	192 (219)	59	6	12	130	145	8.5	$22^0_{-0.013}$	$110^0_{-0.04}$	6	3.5	6	40	50
SF130-2-115M1530-A															
SF130-2-146M1520-A	283 (310)	224 (251)	59	6	12	130	145	8.5	$22^0_{-0.013}$	$110^0_{-0.04}$	6	3.5	6	40	50
SF130-2-146M1530-A															

Note: The value in brackets is the length of the motor with brake.

High Performance Servo motors

Parameter and Dimensions

180 frame

Model	SF180-4-018M1530-A	SF180-4-028M1530-A	SF180-4-035M1530-A	SF180-4-048M1530-A
Rated Power	2.9 KW	4.4 KW	5.5 KW	7.5 KW
Rated Torque	18.6 N.m	28.4 N.m	35 N.m	48 N.m
Rated Speed	1500 rpm	1500 rpm	1500 rpm	1500 rpm
Maximum Speed	3000 rpm	3000 rpm	3000 rpm	3000 rpm
Rated Current	10.6A	16.5A	20.8 A	25.7 A
Rotor Inertia	46 Kg $m^2 \times 10^{-4}$ (54.5 Kg $m^2 \times 10^{-4}$)	67.5 Kg $m^2 \times 10^{-4}$ (75.4 Kg $m^2 \times 10^{-4}$)	89 Kg $m^2 \times 10^{-4}$ (97.5 Kg $m^2 \times 10^{-4}$)	125 Kg $m^2 \times 10^{-4}$ (134Kg $m^2 \times 10^{-4}$)
Maximum Current	28 A	40.5 A	52 A	65 A
Maximum Torque	45.1 N.m	71.1 N.m	87.6N.m	119 N.m

Note: The inertia of the rotor with brake type is in the brackets.

Motor installation dimension drawing

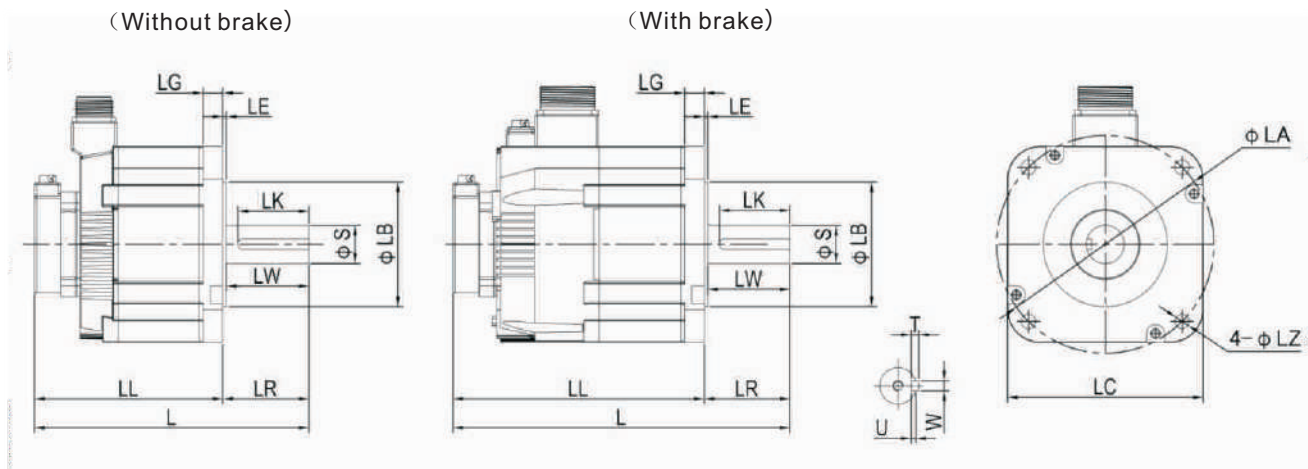

Model	L	LL	LR	LE	LG	LC	LA	LZ	S	LB	T	U	W	LK	TP
SF180-4-018M1530-A	252.3 (310)	173.3 (231)	79	3.2	18	180	200	13.5	35 ^{+0.01} ₀	114.3 ⁰ _{-0.025}	8	5	10	65	75.8
SF180-4-028M1530-A	276.3 (334)	197.3 (255)	79	3.2	18	180	200	13.5	35 ^{+0.01} ₀	114.3 ⁰ _{-0.025}	8	5	10	65	75.8
SF180-4-035M1530-A	349.3 (391)	236.3 (278)	113	3.2	18	180	200	13.5	42 ⁰ _{-0.016}	114.3 ⁰ _{-0.025}	8	5	12	96	109.8
SF180-4-048M1530-A	395.3 (437)	282.3 (324)	113	3.2	18	180	200	13.5	42 ⁰ _{-0.016}	114.3 ⁰ _{-0.025}	8	5	12	96	109.8

Note: The value in brackets is the length of the motor with brake.

Model Designation

SF **130** **-** **2** **-** **048** **M** **20** **30** **B**
 SF Series Flange Power Rated M Rated Maximum Brake
 Servo motor Dim. Voltage Torque Speed Speed

Flange Dim.		Rated Torque		Rated /Max. Speed		Power Voltage		Encoder Type		Brake	
40	40mm	003	0.32 N.m	20	2000 rpm	A	AC220V	2500p/r Wire-saving	B	With brake	
60	60mm	006	0.64 N.m	30	3000 rpm						
80	80mm	013	1.27 N.m	50	5000 rpm						
130	130mm	024	2.40 N.m	60	6000 rpm						
		032	3.18 N.m								
		048	4.8 N.m								
		072	7.2 N.m								
		096	9.6 N.m								

Model List

Model	Rated Torque	Rated Speed	Max Speed	Rated Current	Rated Power	Driver Type
SF40-2-003M3060	0.32 Nm	3000 rpm	6000 rpm	1.1 A	100 W	HSD7-BS-03A□□
SF60-2-006M3060	0.64 Nm	3000 rpm	6000 rpm	1.6 A	200 W	
SF60-2-013M3060	1.27 Nm	3000 rpm	6000 rpm	2.5 A	400 W	
SF80-2-024M3050	2.40 Nm	3000 rpm	5000 rpm	4.0 A	750 W	HSD7-BS-06A□□
SF80-2-032M3050	3.18 Nm	3000 rpm	5000 rpm	6.0 A	1.0 Kw	
SF130-2-048M2030	4.8 Nm	2000 rpm	3000 rpm	4.6 A	1.0 Kw	
SF130-2-072M2030	7.2Nm	2000 rpm	3000 rpm	7.5 A	1.5 Kw	HSD7-BS-08A□□
SF130-2-096M2030	9.6 Nm	2000 rpm	3000 rpm	9.0 A	2.0 Kw	HSD7-BS-10A□□

General Servo motors

Parameter and Dimensions

Model	SF40-2-003M3060	SF60-2-006M3060	SF60-2-013M3060	SF80-2-024M3050	SF80-2-032M3050
Rated Power	100 W	200 W	400 W	750 W	1.0 KW
Rated Torque	0.32 Nm	0.64 Nm	1.27 Nm	2.40 Nm	3.18 Nm
Rated Speed	3000 rpm	3000 rpm	3000 rpm	3000 rpm	3000 rpm
Maximum Speed	6000 rpm	6000 rpm	6000 rpm	5000 rpm	5000 rpm
Rated Current	1.1 A	1.6 A	2.5 A	4 A	6A
Rotor Inertia	0.036Kgm ² ×10 ⁻⁴ (0.037Kgm ² ×10 ⁻⁴)	0.29Kgm ² ×10 ⁻⁴ (0.31Kgm ² ×10 ⁻⁴)	0.56Kgm ² ×10 ⁻⁴ (0.58Kgm ² ×10 ⁻⁴)	1.56Kgm ² ×10 ⁻⁴ (1.66Kgm ² ×10 ⁻⁴)	2.03Kgm ² ×10 ⁻⁴ (2.13Kgm ² ×10 ⁻⁴)
Maximum Current	3.3 A	4.8 A	7.5 A	12 A	18A
Maximum Torque	0.96 Nm	1.92 Nm	3.81 Nm	7.2 Nm	9.54 Nm

Note: The inertia of the rotor with brake type is in the brackets.

40 frame motor installation size

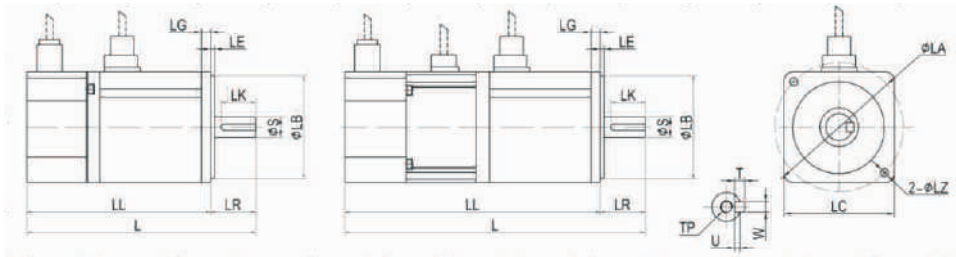

60/80 frame motor installation size

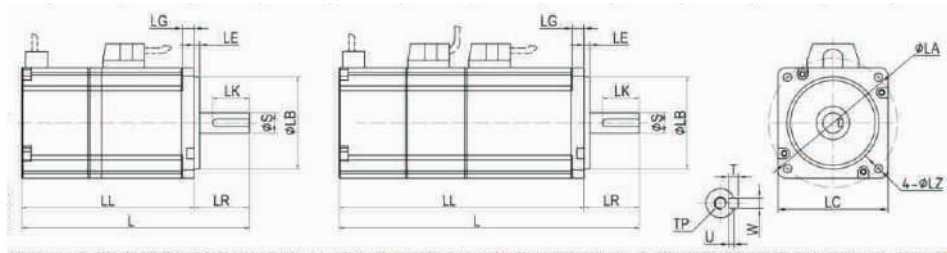

Model	L	LL	LR	LE	LG	LC	LA	LZ	S	LB	T	U	W	LK	TP
SF40-2-003M3060	126 (159)	100.5 (133.5)	25.5	3	5	40	46	4.5	0 8 -0.013	0 30 -0.03	3	1.8	3	14	M3*6
SF60-2-006M3060	123.7 (150.2)	93.7 (120.2)	30	3	6.5	60	70	5.5	0 14 -0.013	0 50 -0.03	5	3	5	20	M5*12
SF60-2-013M3060	140.7 (167.2)	110.7 (137.2)	30	3	6.5	60	70	5.5	0 14 -0.013	0 50 -0.03	5	3	5	20	M5*12
SF80-2-024M3050	157.4 (185.6)	122.4 (150.6)	35	3	9	80	90	6.3	0 19 -0.013	0 70 -0.03	6	3.5	6	25	M5*12
SF80-2-032M3050	171.4 (199.6)	136.4 (164.6)	35	3	9	80	90	6.3	0 19 -0.013	0 70 -0.03	6	3.5	6	25	M5*12

Note: The value in brackets is the length of the motor with brake.

Parameter and Dimensions

130 frame

Model	SF130-2-048M2030	SF130-2-072M2030	SF130-2-096M2030
Rated Power	1.0 KW	1.5 KW	2.0 KW
Rated Torque	4.8 Nm	7.2 Nm	9.6 Nm
Rated Speed	2000 rpm	2000 rpm	2000 rpm
Maximum Speed	3000 rpm	3000 rpm	3000 rpm
Rated Current	4.6 A	7.5 A	9.0 A
Rotor Inertia	13.88 Kg $m^2 \times 10^{-4}$ (15.55 Kg $m^2 \times 10^{-4}$)	18.57 Kg $m^2 \times 10^{-4}$ (20.24 Kg $m^2 \times 10^{-4}$)	23.69 Kg $m^2 \times 10^{-4}$ (25.36 Kg $m^2 \times 10^{-4}$)
Maximum Current	13.8A	22.5A	27.0A
Maximum Torque	14.4 Nm	21.6 Nm	28.8 Nm

Note: The inertia of the rotor with brake type is in the brackets.

130 frame motor installation size

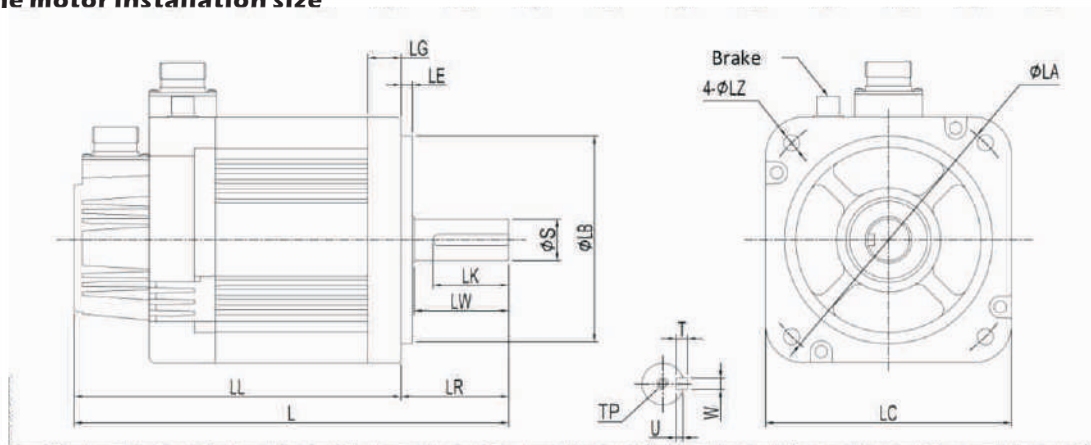

Model	L	LL	LR	LE	LG	LC	LA	LZ	S	LB	T	U	W	LK	LW	TP
SF130-2-048M2030	207 (230)	150 (173)	57	6	17.5	130	145	8.5	22 ⁰ _{-0.013}	110 ⁰ _{-0.04}	6	3.5	6	40	2.5	M6*20
SF130-2-072M2030	221 (244)	164 (187)	57	6	17.5	130	145	8.5	22 ⁰ _{-0.013}	110 ⁰ _{-0.04}	6	3.5	6	40	2.5	M6*20
SF130-2-096M2030	235 (258)	178 (201)	57	6	17.5	130	145	8.5	22 ⁰ _{-0.013}	110 ⁰ _{-0.04}	6	3.5	6	40	2.5	M6*20

Note: The value in brackets is the length of the motor with brake.



HNC ELECTRIC LIMITED is a company dedicated to the development and production of intelligent industrial automation solutions based on national strategic needs. Supported by its outstanding electrical and electronic technology and strong control technology, it provides control, display, drive and system solutions and other related products and services to customers worldwide.

With 25 years of hard work, we have developed and produced professional CNC systems, industrial robots, servo drives, servo motors, reducers, inverters, PLCs, HMIs, etc. In more than 50 countries and regions around the world, we have established a comprehensive agent system and after-sales service system. In the future, we will, as always, provide more professional services for global industrial automation.



Thanks for choosing HNC product
Any technique support, please feel to contact our support team

URL: www.hncelectric.com
Email: info@hncelectric.com