

## 38 W SELV Dimmable DALI-2 LED driver

Product code: 5901

38 W 220 – 240 V 50 – 60 Hz

- DALI-2 certified LED driver, 1-100 % dimming range
- SELV output protection for safety and flexibility in luminaires
- Amplitude dimming for the highest quality light output
- Low current ripple, complying with IEEE 1789 recommendation
- Suitable for use in emergency lighting applications
- Compact dimensions for flexible usage
- Ideal solution for Class I and Class II



### Functional Description

- Adjustable constant current output: 300 mA (default) to 1050 mA
- Current setting via with dip-switches
- Amplitude dimming technology for the highest quality light in every application
- Suitable for flicker-free camera recording applications
- Overload, open & short circuit protection

### Mains Characteristics

Nominal rated voltage range	220 V – 240 V, 50 – 60 Hz
Rated emergency voltage range	196 V – 250 V, 0 Hz
AC voltage range	198 VAC – 264 VAC
DC voltage range	176 VDC - 275 VDC
Mains current at full load	0.16 – 0.20 A
Frequency	50 Hz – 60 Hz
Stand-by power consumption	< 0.5 W
THD at full power	< 10 %
Tested surge protection	4 kV L/N-GND (IEC 61000-4-5) 2 kV L-N (IEC 61000-4-5)
Tested fast transient protection	2 kV (IEC 61000-4-4)

### Insulation between circuits & driver case

Mains circuit - SELV circuit	Double/reinforced insulation
DALI circuit - SELV circuit	Double/reinforced insulation
Mains circuit - DALI circuit	Basic insulation
Mains, DALI and output - Driver case	Double/reinforced insulation

### Load Output (SELV <60 V)

Output current ( $I_{out}$ )	300 mA (default) – 1050 mA
Accuracy	± 5 %
Ripple	< 3 %* at ≤ 120 Hz
PstLM	*] Low frequency, LED load: Cree XP-G LEDs < 0.10*
SVM	< 0.02*
$U_{out}$ (max) (abnormal)	*] At full power, measured with Cree XP-G LED modules. 59 V
EOF <sub>I</sub> (EL use)	> 0.98 x output current with AC supply

	300 mA	700 mA	1050 mA
$I_{LED}$	300 mA	700 mA	1050 mA
$P_{Rated}$	16 W	37.8 W	38 W
$U_{LED}$	10 - 54 V	10 - 54 V	10 - 36 V
PF (λ) at full load	0.95	0.95	0.95
Efficiency (η) at full load	88 %	90 %	89 %

ENEC certified U-LED voltage range is 18 - 54 V, however LC38MINI-DA-300-1050 supports LED loads down to 10 V.

## Operating window

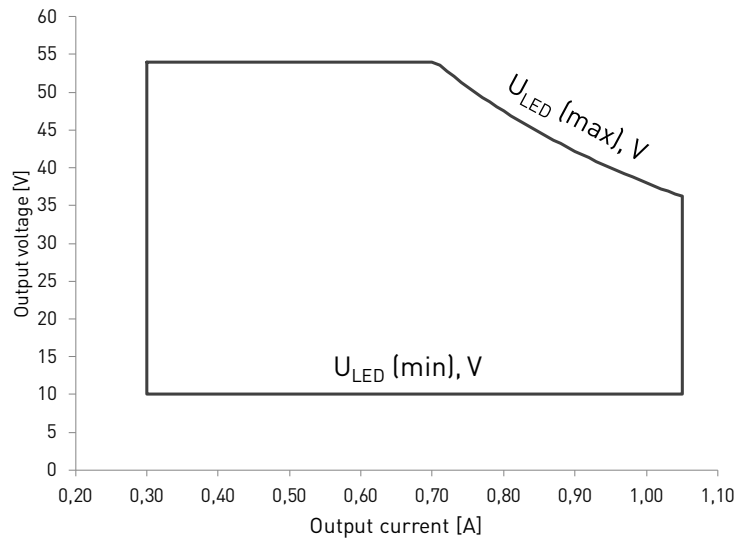

Note: 1) Dimming between 1 % - 100 % possible across the operating window, restricted by the absolute minimum dimming current of 7 mA.  
 2) Current value is adjustable in steps via dip-switch. See dip-switch settings in page 3 for details.

## Driver performance

Typical efficiency

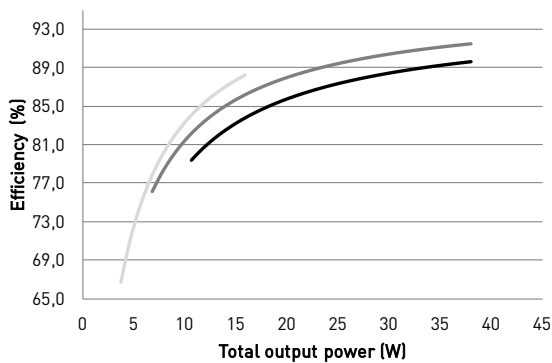

Typical power factor

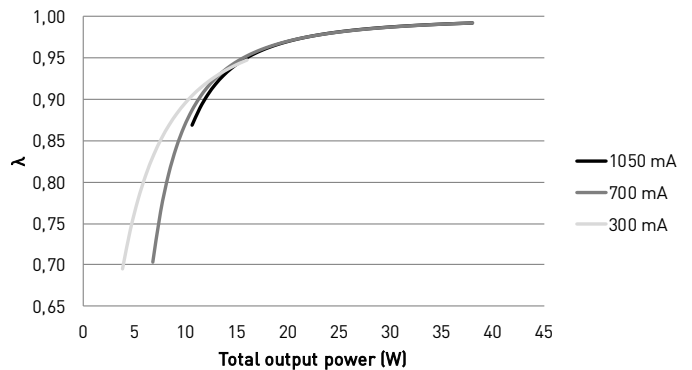

## Operating Conditions and Characteristics

Absolute highest allowed $t_c$ point temperature	85 °C
$T_c$ life (50 000 h) temperature	80 °C
Ambient temperature range	-25 °C ... +50 °C*
Storage temperature range	-40 °C ... +80 °C
Maximum relative humidity	No condensation
Life time (90 % survival rate)	80 000 h, at $t_c = 75$ °C
	50 000 h, at $t_c = 80$ °C
	40 000 h, at $t_c = 85$ °C

\*] For other than independent use, higher  $t_g$  of the controlgear possible as long as highest allowed  $t_c$  point temperature is not exceeded

## Amplitude dimming technology

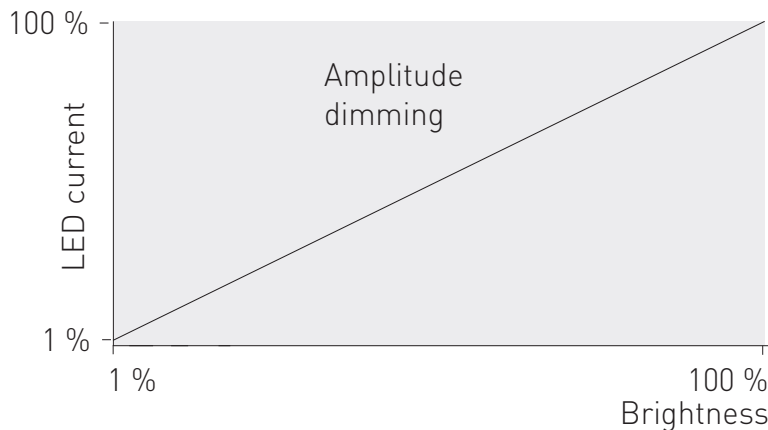

Dimming range	Dimming technology
1 % – 100 %	Amplitude (DC)

LC38MINI-DA-300-1050 LED driver implements amplitude dimming technology across whole dimming range. Amplitude dimming offers the best available technology for dimming the light output in an accurate and flicker-free way to ensure high quality lighting in even the most demanding situations such as camera recording applications. Amplitude dimming technology complies with IEEE 1789-2015 recommendations of current modulation to mitigate health risks to viewers.

## Quantity of drivers per miniature circuit breaker 16 A Type C

Based on inrush current $I_{peak}$	Typ. peak inrush current $I_{peak}$	1/2 value time, $\Delta t$
85 pcs.	5 A	50 $\mu s$

## CONVERSION TABLE FOR OTHER TYPES OF MINIATURE CIRCUIT BREAKER

MCB type	Relative quantity of LED drivers
B 10 A	37 %
B 16 A	60 %
B 20 A	75 %
C 10 A	62 %
C 16 A	100 % (see table above)
C 20 A	125 %

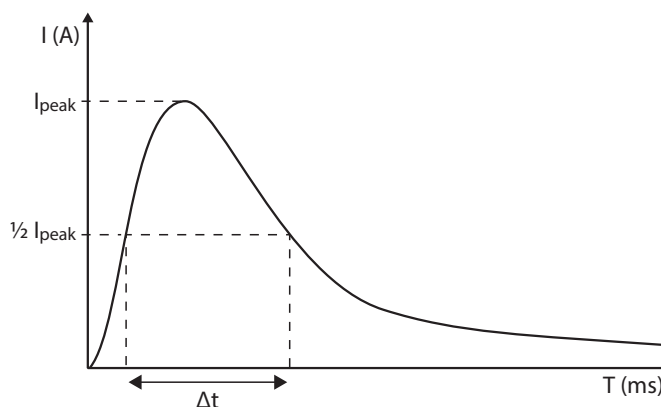

## CONTINUOUS CURRENT

Total continuous current of the drivers and installation environment must always be considered and taken into calculations when installing drivers behind miniature circuit breaker. Example calculation of total drivers amount limited by continuous current:  $n(I_{cont}) = (16 A (I_{nom,Ta}) / \text{“nominal mains current with full load”}) \times 0.76$ . This calculation is an example according to recommended precautions due to multiple adjacent circuit breakers (> 9 MCBs) and installation environment ( $T_a$  30 degrees); variables may vary according to the use case. Both inrush current and continuous current calculations are based on ABB S200 series circuit breakers. More specific information in ABB series S200 circuit breaker documentation.

NOTE! Type C MCB's are strongly recommended to use with LED lighting. Please see more details in "MCB information" document in each driver product page in "downloads & links" section.

## Connections and Mechanical Data

Wire size	0.5 mm <sup>2</sup> – 1.5 mm <sup>2</sup>
Wire type	Solid core and fine-stranded
Wire insulation	According to EN 60598
Maximum driver to LED wire length	1.5 m
Weight	119 g
IP rating	IP20

## Connections

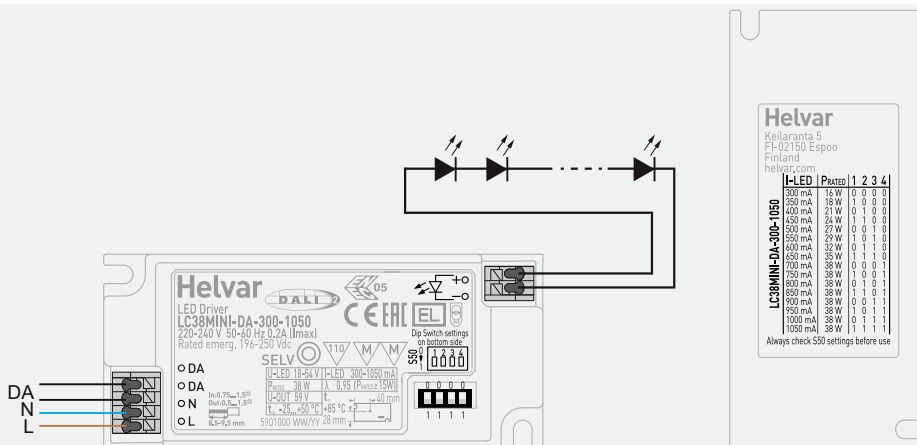

Note:

- Not suitable for load side switching operation
- ENEC certified U-LED voltage range is 18 - 54 V, however LC38MINI-DA-300-1050 supports LED loads down to 10 V.

## Dimensions (mm)

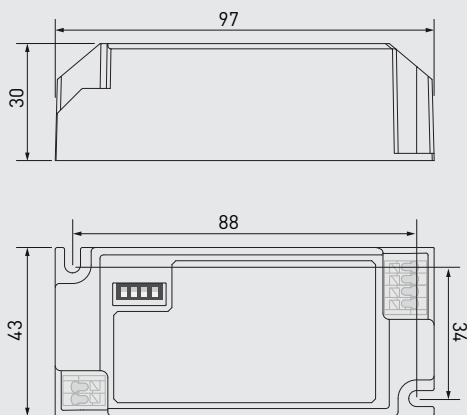

In LC38MINI-DA-300-1050, the current can be set with dip-switches. With each combination of switch setup, a different output current value can be set. The maximum value can be reached with all switches set to "1" (pushed away from label, see connections picture above) and minimum with all switches set to "0" (pushed towards the label). The output current values according to the dip-switch settings are presented below.

### Dip-switch combinations and currents (Nominal I<sub>out</sub> (±5 % tol.))

Dip-Switch combination	1111	0111	1011	0011	1101	0101	1001	0001
I <sub>out</sub> (mA)	1050	1000	950	900	850	800	750	700
Voltage range	10 - 36 V	10 - 38 V	10 - 40 V	10 - 43 V	10 - 45 V	10 - 48 V	10 - 51 V	10 - 54 V
Dip-Switch combination	1110	0110	1010	0010	1100	0100	1000	0000
I <sub>out</sub> (mA)	650	600	550	500	450	400	350	300
Voltage range	10 - 54 V	10 - 54 V	10 - 54 V	10 - 54 V	10 - 54 V	10 - 54 V	10 - 54 V	10 - 54 V

LC38MINI-DA-300-1050 LED driver is suited for built-in usage in luminaires. In order to have safe and reliable LED driver operation, the LED luminaires will need to comply with the relevant standards and regulations (e.g. IEC/EN 60598-1). The LED luminaire shall be designed to adequately protect the LED driver from dust, moisture and pollution. The luminaire manufacturer is responsible for the correct choice and installation of the LED drivers according to the application and product datasheets. Operating conditions of the LED drivers may never exceed the specifications as per the product datasheet.

## Installation & operation

### Maximum ambient and $t_c$ temperature:

- For built-in components inside luminaires, the  $t_a$  ambient temperature range is a guideline given for the optimum operating environment. However, integrator must always ensure proper thermal management (i.e. mounting base of the driver, air flow etc.) so that the  $t_c$  point temperature does not exceed the  $t_c$  maximum limit in any circumstance.
- Reliable operation and lifetime is only guaranteed if the maximum  $t_c$  point temperature is not exceeded under the conditions of use.

### Current setting via dip-switch

LC38MINI-DA-300-1050 LED driver features a constant current output adjustable via dip-switch combinations.

- For the combination/current values, refer to the table on page 4.

### Miniature Circuit Breakers (MCB)

- Type-C MCB's with trip characteristics in according to EN 60898 are recommended.
- Please see more details in "MCB information" document in each driver product page in "downloads & links" section.

## Lamp failure functionality

### No load

When open load is detected, driver limits output voltage according to  $U_{out} (max)$  (abnormal).

### Overload

Driver can withstand overload, however reliable operation is only guaranteed in specified voltage range.

### Short circuit

Driver can withstand output short circuit.

## Conformity & standards

General and safety requirements	EN 61347-1: 2015
Particular safety requirements for DC or AC supplied electronic control gear for LED modules	EN 61347-2-13: 2014 + A1: 2017
Additional safety requirements for AC or DC supplied electronic controlgear for emergency lighting	EN 61347-2-13: 2014 + A1:2017, Annex J
Thermal protection class	EN 61347, C5a
Mains current harmonics	EN 61000-3-2: 2014
Limits for voltage fluctuations and flicker	EN 61000-3-3: 2013
Radio frequency interference	EN 55015: 2013
Immunity standard	EN 61547: 2009
Performance requirements	EN 62384: 2006+ A1:2009
<b>Digital addressing lighting interface:</b>	
General requirements for DALI system	EN 62386-101 (DALI-2)
Requirements for DALI control gear	EN 62386-102 (DALI-2)
Requirements for control gear of LED modules (DALI Device Type 6)	EN 62386-207 (DALI-2)
Recommended Practices for Modulating Current in High-Brightness LEDs for Mitigating Health Risks to Viewers	IEEE 1789-2015
Compliant with relevant EU directives	
RoHS / REACH compliant	
ENEC and CE / UKCA marked	

## Label symbols



Safety isolating control gear with short circuit protection (SELV control gear).



Double insulated control gear suitable for built-in use.



Thermally controlled control gear, incorporating means of protection against overheating to prevent the case temperature under any conditions of use from exceeding 110 °C.



Controlgear allowed to be installed to normally flammable surfaces according to German DIN VDE 0710-14 standard



DALI-2 certified control gear.



AC/DC supplied electronic control gear for emergency lighting purposes intended for connection to a centralized emergency power supply.