

# FFIZ/OP-1E

cylindrical photosensors



Micro Detectors

Italian Sensors Technology



Indicative image

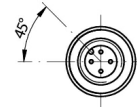
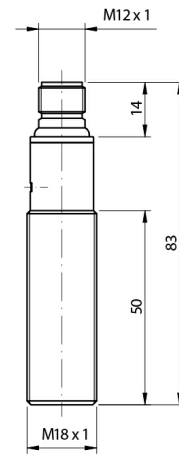

## Detection properties

Nominal sensing distance	20.000mm
Thermal drift of Sr	10% Sr
Repeat Accuracy	5%

## Application

Function Principle	Receiver
Emitter/Receiver	Receiver
Optic position	Axial

## Outputs

Output type	PNP
Output Function	LO/DO
Switching frequency	250Hz

## Electrical data

Operating Voltage	10...30Vdc
No-Load supply current	25mA

Load current	100mA
Leakage current	≤10μA
Output voltage drop	≤2V IL=100mA
Max ripple content	≤10%
LED indicators	Yellow: output state
Time delay before availability	200ms
Short-circuit protection	Yes
Reverse Polarity Protection	Yes
Emission	Infrared (880nm)
Interference to external light	5.000lux (incandescent lamp), 10.000lux (sunlight)

## Mechanical data

Dimensions	M18x1/L=83mm
Weight	60g
Housing Material	Stainless steel AISI 316L / PA12 plug
Connections	M12 plug
Active Head Material	PA12
Tightening torque	50Nm
Operating temperature	-25°C...+80°C (without freeze)
Diameter/Dimension	M18

## Test/Approvals

Approvals	CE, Ex, Diversey, ECOLAB, cULus
EMC compatibility	EN 60947-5-2
Shocks and vibrations	Vibration IEC 60068-2-6 / Shock IEC 60068-2-27
Degree of protection	IP68, IP69K

## Accessories

Supplied Accessories	Metallic nut (2x)
----------------------	-------------------

---

# ELECTRICAL DIAGRAMS OF THE CONNECTIONS

---

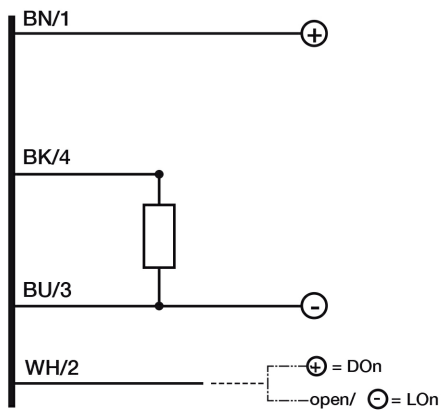

## CONNECTOR

---

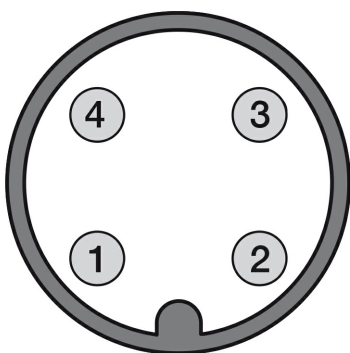

## RESPONSE CURVES

---

### Dimensione Spot

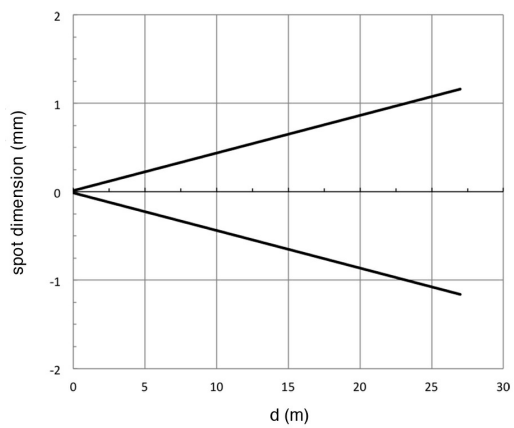

### Disassamento Parallelo

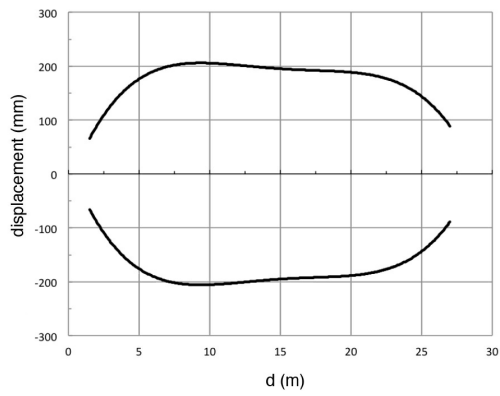

## Eccesso di Guadagno

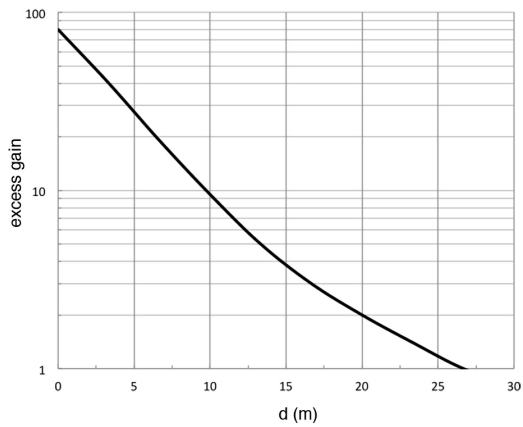

**M.D. Micro Detectors S.p.A.**

Strada S. Caterina, 235

41122 Modena (MO)

Tel. 059 420411

Fax 059 253973

E-mail [info@microdetectors.com](mailto:info@microdetectors.com)

**date of printing**

19/11/2021 12:48:46