

FFI8/0P-1E

cylindrical photosensors



Micro Detectors

Italian Sensors Technology



Indicative image

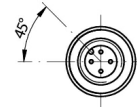
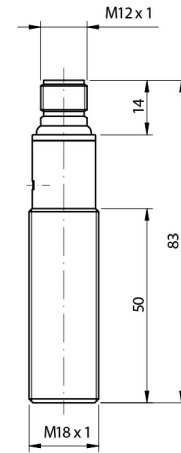

Detection properties

Nominal sensing distance	800mm
Thermal drift of Sr	10% Sr
Repeat Accuracy	5%
Sensitivity adjustment	Teach

Application

Function Principle	Diffuse reflection (long distance, >600mm)
Notes	White target Kodak 90% reflection 400x400 mm
Optic position	Axial

Outputs

Output type	PNP
Output Function	LO/DO
Switching frequency	500Hz

Electrical data

Operating Voltage	10...30Vdc
-------------------	------------

No-Load supply current	≤35mA (at Val=30V)
Load current	100mA
Leakage current	≤10μA
Output voltage drop	≤2V IL=100mA
Max ripple content	≤10%
LED indicators	Green: ON-teach function available; OFF-teach function blocked; fast flashing-fine teach active; slow flashing- teach in progress Yellow: output state-excess gain
Time delay before availability	200ms
Short-circuit protection	Yes
Reverse Polarity Protection	Yes
Emission	Infrared (880nm)
Interference to external light	5.000lux (incandescent lamp), 10.000lux (sunlight)

Mechanical data

Dimensions	M18x1/L=83mm
Weight	60g
Housing Material	Stainless steel AISI 316L / PA12 plug
Connections	M12 plug
Active Head Material	PA12
Tightening torque	50Nm
Operating temperature	-25°C...+80°C (without freeze)
Diameter/Dimension	M18

Test/Approvals

Approvals	CE, Ex, Diversey, ECOLAB, cULus
EMC compatibility	EN 60947-5-2
Shocks and vibrations	Vibration IEC 60068-2-6 / Shock IEC 60068-2-27
Degree of protection	IP68, IP69K

Accessories

Supplied Accessories	Metallic nut (2x)
----------------------	-------------------

ELECTRICAL DIAGRAMS OF THE CONNECTIONS

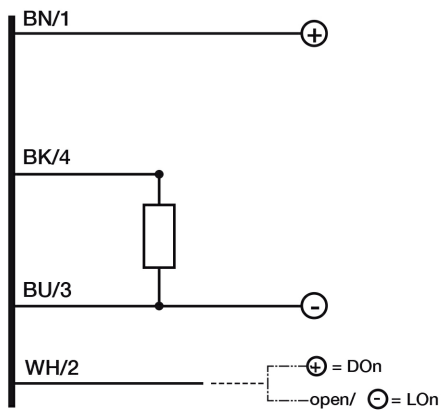

CONNECTOR

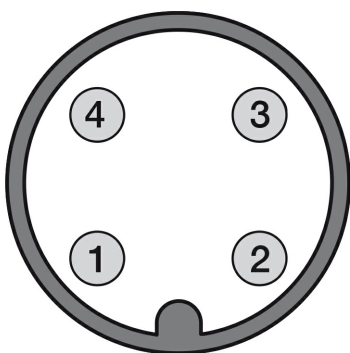

RESPONSE CURVES

Dimensione Spot

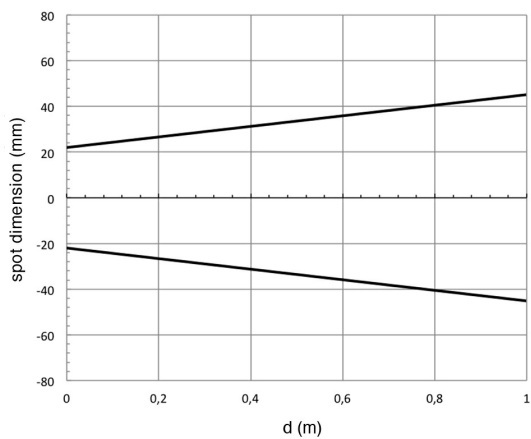

Disassamento Parallelo

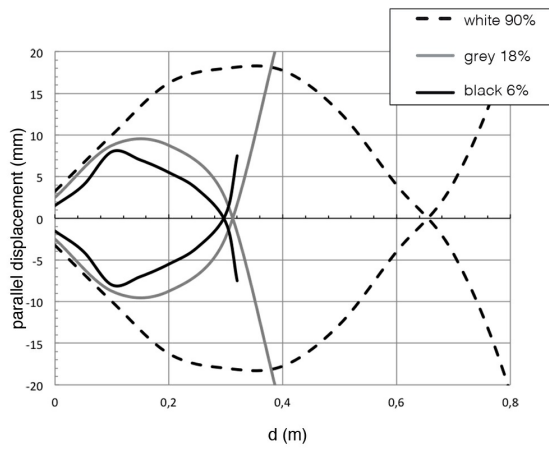

Eccesso di Guadagno

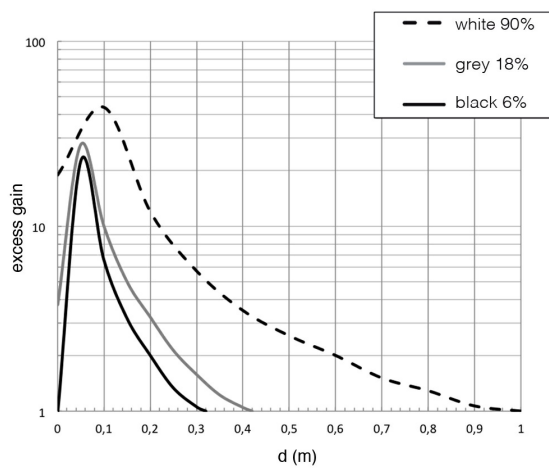

M.D.Micro Detectors S.p.A.

Strada S.Caterina, 235

41122 Modena (MO)

Tel. 059 420411

Fax 059 253973

E-mail info@microdetectors.com

date of printing

19/11/2021 11:42:29