

QFRN/BP-1A

cubic photosensors



Micro Detectors

Italian Sensors Technology



Indicative image

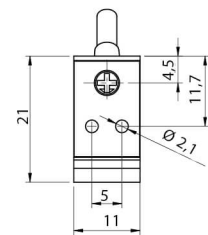
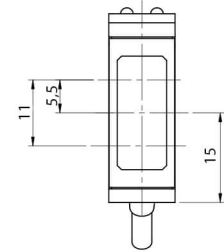
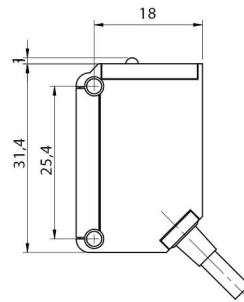

Detection properties

Nominal sensing distance 6m with reflector RL110

Repeat Accuracy 5%

Sensitivity adjustment Trimmer

Application

Function Principle Polarized

Notes with reflector RL110

Emitter/Receiver Emitter/Receiver

Optic position 90°

Outputs

Output type PNP

Output Function NO+NC

Switching frequency 1kHz

Electrical data

Operating Voltage 10-30Vdc

No-Load supply current ≤25mA

Load current ≤100mA

Leakage current	≤100μA
Output voltage drop	2V max. IL =100 mA
Max ripple content	10%
LED indicators	Yellow (status output) , green (power on, excess gain)
Time delay before availability	≤30ms
Short-circuit protection	Yes
Reverse Polarity Protection	Yes
Emission	Red (625nm)
Interference to external light	≤10000lux
Impulsive Overvoltage Protection	Yes

Mechanical data

Dimensions	31,4x21x11mm
Weight	100g
Housing Material	Stainless steel 316L
Connections	2m PVC cable
Active Head Material	PPSU
Operating temperature	- 25°C...+ 60° C (Without freeze)
Storage temperature	-40° ... +70°C
Diameter/Dimension	Cubic

Test/Approvals

Approvals	CE cULus, ECOLAB
EMC compatibility	EN 60947-5-2
Shocks and vibrations	Vibration IEC 60068-2-6 / Shock IEC 60068-2-27
Degree of protection	IP68, IP69K

Accessories

Supplied Accessories Mouting bracket screwdriver

ELECTRICAL DIAGRAMS OF THE CONNECTIONS

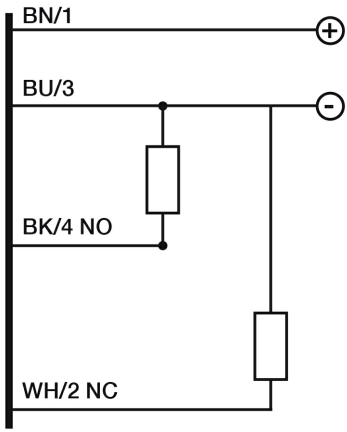

RESPONSE CURVES

Dimensione Spot

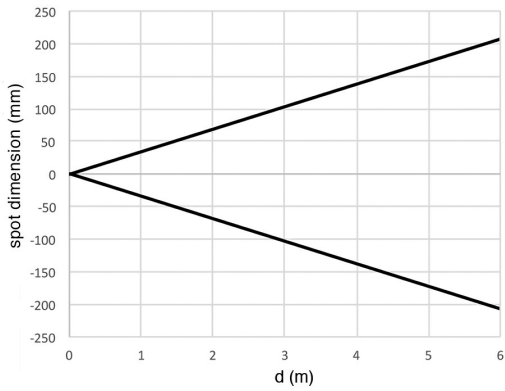

Disassamento Parallelo

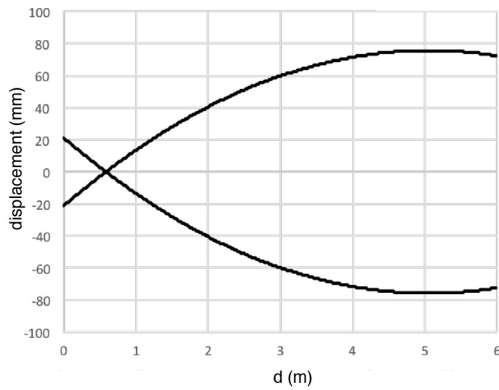

Eccesso di Guadagno

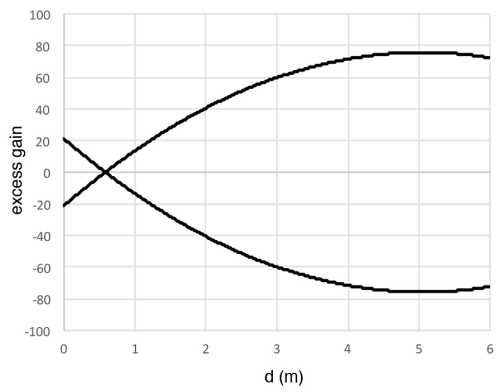

M.D. Micro Detectors S.p.A.

Strada S. Caterina, 235

41122 Modena (MO)

Tel. 059 420411

Fax 059 253973

E-mail info@microdetectors.com

date of printing

19/11/2021 09:05:54