



Mastercool[®] Inc.
"World Class Quality"

English

Deutsch

Français

Español

Italiano

Portuguese

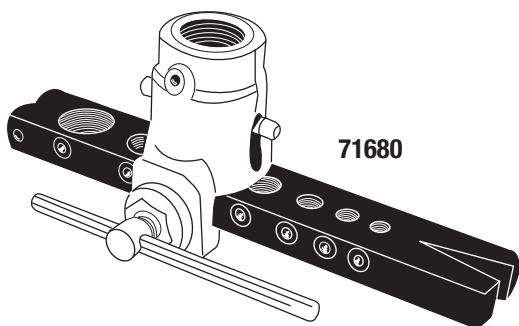

**INSTRUCTION MANUAL
HYDRAULIC FLARING ACCESSORY**

**GEBRAUCHSANWEISUNG
HYDRAULIK BÖRDEL ZUBEHÖR**

**MANUEL D'INSTRUCTIONS
ACCESSOIRE POUR DUDGEONNER AVEC
L'EXPANDEUR HYDRAULIQUE**

**MANUAL DE INSTRUCCIONES
PIEZA HIDRÁULICA PARA ABOCINAR**

**MANUALE D'ISTRUZIONI
ACCESSORIO PER FANGIATURA IDRAULICA**

**INSTRUÇÕES
FLANGEADOR HIDRÁULICO ACESSÓRIO**

HYDRAULIC FLARING ACCESSORY INSTRUCTIONS

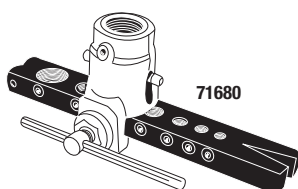

WARNING



Wear Safety Goggles

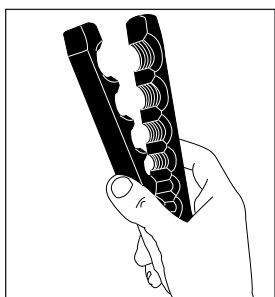

1.) Take the bar and open it.

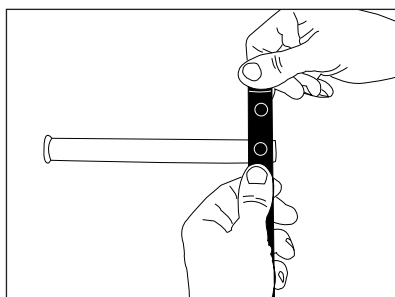

2.) Install the copper tube at the desired size and line up to the bar.

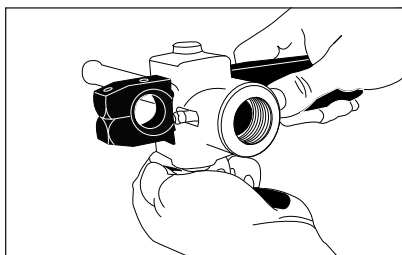

3.) Slide the yoke over the bar until the bars line up to the copper tube at the selected size. Tighten the handle on the yoke.

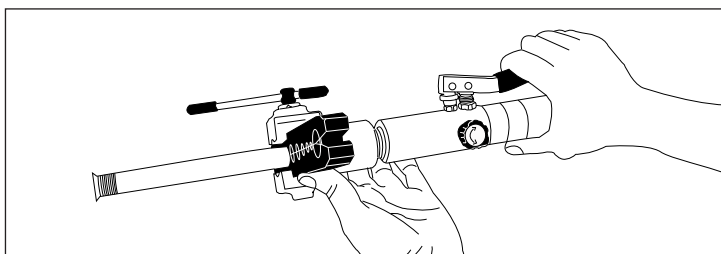

4.) Assemble the hydraulic pump. Turn the hydraulic bar until it is tight. Close the relief valve knob and pump handle until it becomes firm.

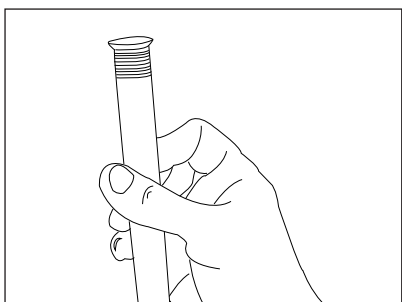

5.) Loosen the relief valve, unscrew the pump and disassemble yoke from bar.

GEBRAUCHSANWEISUNG ZUR HYDRAULIK BÖRDEL ZUBEHÖR

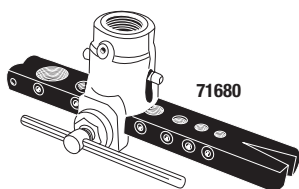

! ACHTUNG

👁 Schutzbrille tragen

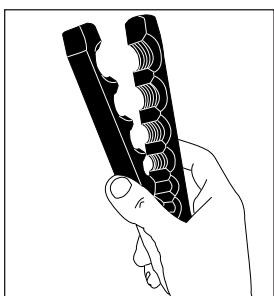

1.) Den Bördelblock öffnen.

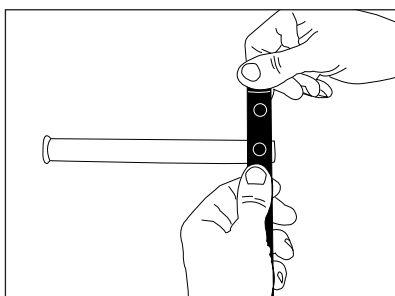

2.) Das Kupferrohr in die richtige Abmessung einbringen und an dem Bördelblock säumen.

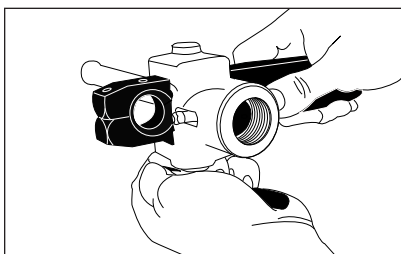

3.) Den Bügel über den Bördelblock schieben, bis auf das Kupferrohr. Den Griff am Bügel anziehen.

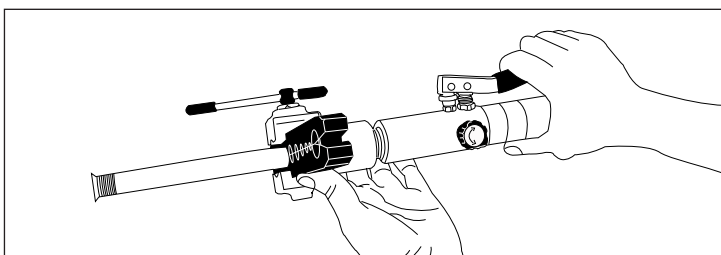

4.) Montieren Sie die Hydraulikpumpe. Drehen bis sie fest sitzt. Schliessen des Entlastungsventilknopfes. Pumpen Sie jetzt den Griff, bis man nicht weiter kann.

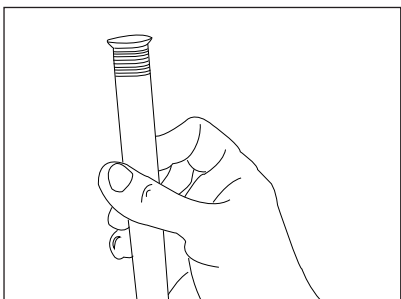

5.) Lösen des Entlastungsventilknopfes. Die Hydraulikpumpe abschrauben und den Bügel vom Bördelblock erweitern.

INSTRUCTIONS SUR ACCESSOIRE POUR DUDGEONNER AVEC L'EXPANDEUR HYDRAULIQUE

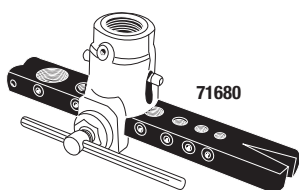

! AVERTISSEMENT  Porter des lunettes de sécurité

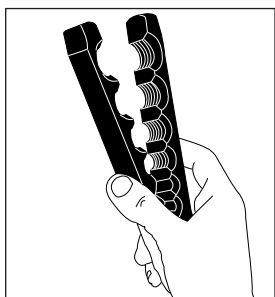

1.) Ouvrir la barrette

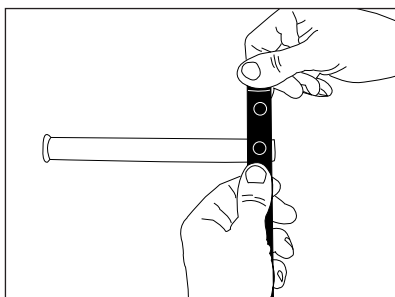

2.) Poser le tube de cuivre dans la dimension correcte et aligner

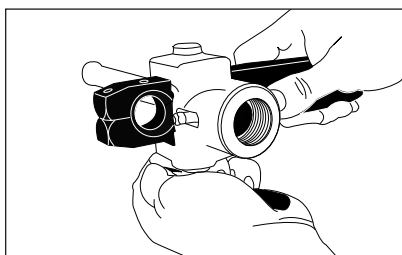

3.) Glisser le dudgeon à travers la barrette jusqu'à sur le tube. Serrer la poignée.

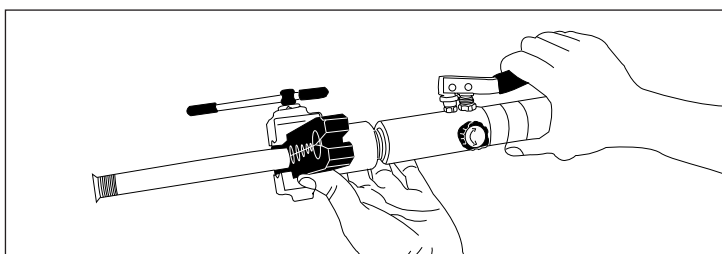

4.) Assembler la pompe hydraulique. Tourner la barrette jusqu'à ce qu'elle est serrée. Fermer la vanne de décharge et pomper la poignée jusqu'à ce qu'on ne peut plus.

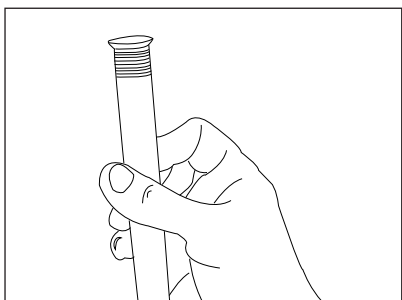

5.) Desserrer la vanne de décharge, dévisser la pompe et enlever le dudgeon de la barrette.

INSTRUCCIONES PIEZA HIDRÁULICA PARA ABOCINAR

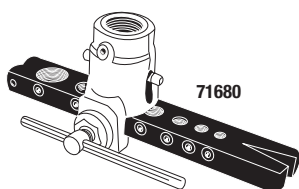

ADVERTENCIA



Use Anteojos de Seguridad

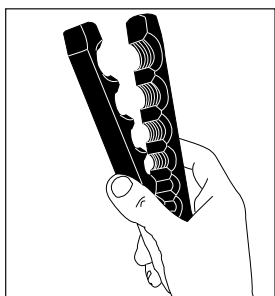

1.) Tome la barra y abra la.

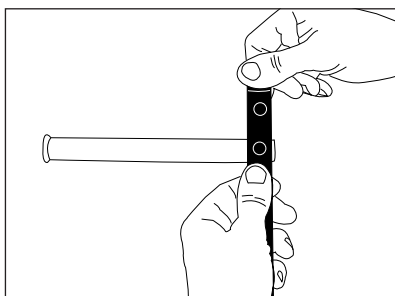

2.) Instale el tubo de cobre en el tamaño deseado y alínelo con la barra.

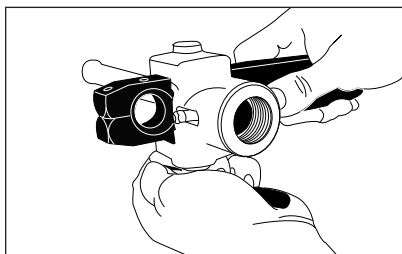

3.) Deslice la abrazadera sobre la barra hasta que quede alineada con el tubo de cobre en el tamaño seleccionado. Apriete la manija en la abrazadera.

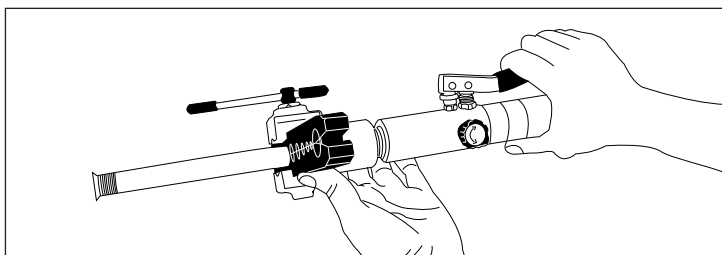

4.) Monte la bomba hidráulica. Gire la barra hidráulica hasta que esté firme. Cierre la perilla de la válvula de alivio y la bomba manija hasta que quede firme.

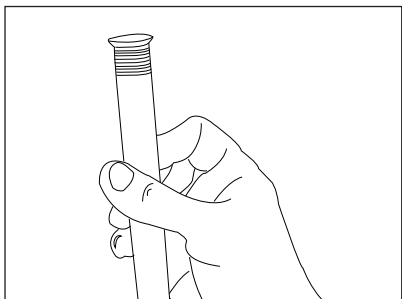

5.) Afloje la válvula de seguridad, desenrosque la bomba y desmonte la abrazadera de la barra.

ACCESSORIO PER FANGIATURA IDRAULICA ISTRUZIONI

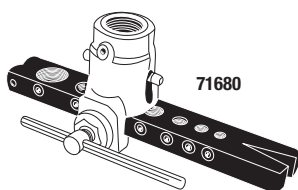

 **ATTENZIONE**

 **Indossare occhiali di sicurezza**

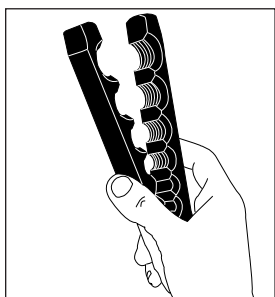

1.) Prendere la barra ed aprirla

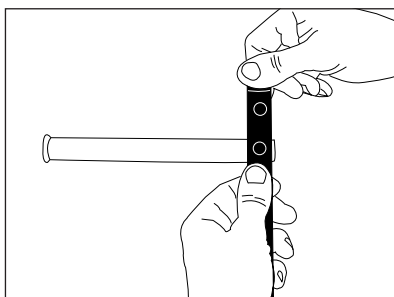

2.) Inserire il tubo di rame nella dimensione corretta ed allinearlo con la barra

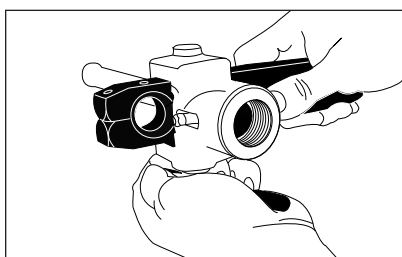

3.) Far scorrere il giogo sulla barra sino ad allinearlo al tubo e alla dimensione selezionata. Stringere la maniglia del giogo

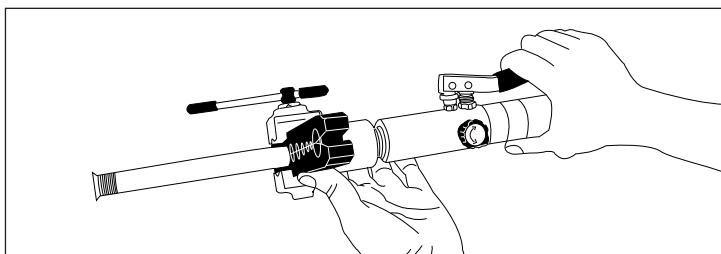

4.) Assemblare la pompa idraulica. Avvitare la pompa idraulica fino a che non risulta fissata. Chiudere la valvola e pompare fino a realizzare la cartella

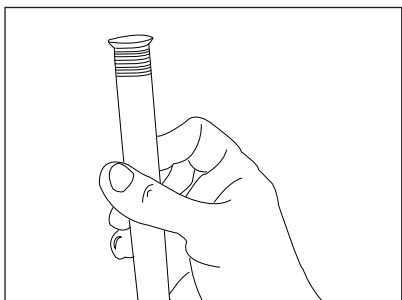

5.) Aprire la valvola, svitare la pompa e disassemblare il giogo dalla barra

FLANGEADOR HIDRÁULICO ACESSÓRIO INSTRUÇÕES

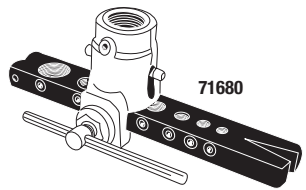

! ATENÇÃO

Use óculos de segurança

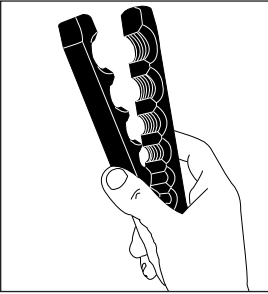

1.) Abra a mesa do flangeador

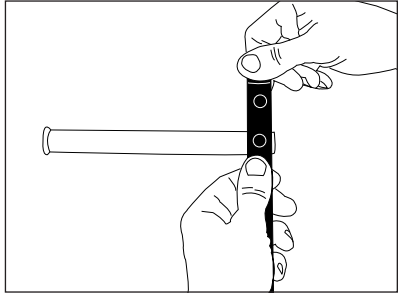

2.) Escolha o tamanho desejado e alinhe a altura do tubo com a mesa.

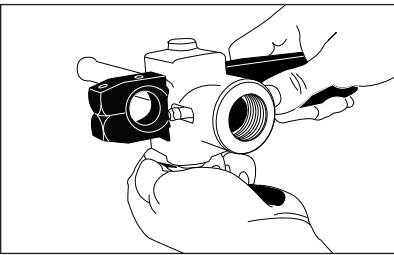

3.) Deslize o cabeçote flangeador na mesa até alinhá-lo com no tamanho de tubo selecionado. Aperte o manipulador do cabeçote flangeador.

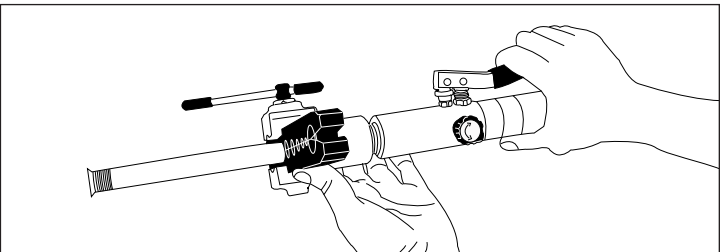

4.) Monte a ferramenta Hidráulica. Rosqueie o hidráulico até o ajuste final. Feche o registro da válvula e bombeie o manipulador hidráulico até que este esteja firme.

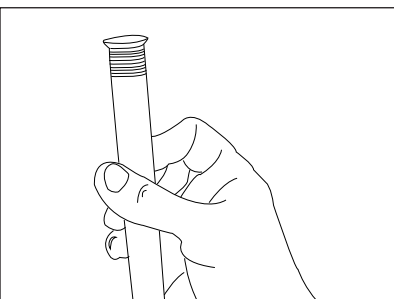

5.) Solte o registro da válvula hidráulica, desrosqueie o hidráulico e desmonte o cabeçote flangeador da mesa.



USA

PH (973) 252-9119

Belgium

TELEFON +32 (0) 3 777 28 48

Brasil

TELEFONE +55 (11) 4407 4017