



Level



Pressure



Flow



Temperature



Liquid
Analysis



Registration



Systems
Components



Services



Solutions

Operating Instructions

Ceraphant T PTC31, PTP31, PTP35

Process pressure measurement

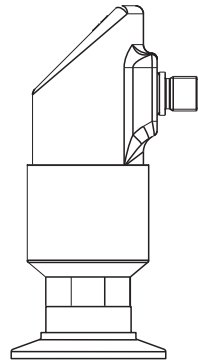
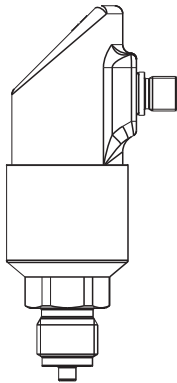

KA00225P/00/EN/14.11
71137689

Release 1.05

Endress+Hauser

People for Process Automation

Table of contents

1	Safety instructions	3
1.1	Designated use	3
1.2	Installation, commissioning and operation	3
1.3	Operational and process safety	3
2	Identification	4
2.1	Nameplate	4
2.2	CE mark, declaration of conformity	5
2.3	Registered trademarks	5
3	Installation	6
3.1	Incoming acceptance, storage	6
3.2	Installation instructions	6
3.3	Post-installation check	7
4	Wiring	8
4.1	DC voltage version with M12 connector	8
4.2	DC voltage version with valve connector	8
4.3	DC voltage version with cable	9
4.4	Supply voltage	9
4.5	Current consumption	9
4.6	Post-connection check	9
5	Operation	10
5.1	On-site operation	10
5.2	Operation with personal computer	13
6	Commissioning	15
6.1	Function check	15
6.2	Basic settings	15
6.3	Output setting	16
6.4	Service function setting	18
7	Maintenance	19
7.1	Exterior cleaning	19
8	Accessories	20
8.1	Process connection	20
8.2	Welding bosses	24
8.3	Electrical connection	25
8.4	ReadWin	26
9	Trouble-shooting	27
9.1	Errors and warnings	27
9.2	Repair	28
9.3	Return	28
9.4	Disposal	28
9.5	Change status (release)	28
9.6	Change status - history	29
10	Technical data	29
	Index	30

1 Safety instructions

1.1 Designated use

The Ceraphant T is a pressure switch for measuring and monitoring absolute and gauge pressures. The device has been safely built with state-of-the-art technology and meets the applicable requirements and EC Directives. It can, however, be a source of danger if used incorrectly or for anything other than the designated use.

1.2 Installation, commissioning and operation

Installation, electrical connection, commissioning, operation and maintenance of the measuring system must be carried out by trained, qualified specialists authorised to perform such work by the facility's owner-operator. The specialist must have read and understood these Operating Instructions and must follow the instructions they contain. The device may only be modified and repair work carried out if this is explicitly permitted in the Operating Instructions. Damaged devices which could be a source of danger may not be commissioned and must be labelled and identified as defective.

1.3 Operational and process safety

Explosion-hazardous areas:

The Ceraphant T is not approved for use in Ex-areas.

Alternative monitoring measures have to be taken while configuring, testing or servicing the device to ensure the operational and process safety.



Warning!

Only disassemble the device in pressurless condition!

2 Identification

2.1 Nameplate

To identify your device, compare the complete order code and the version information on the delivery papers with the data on the nameplate.

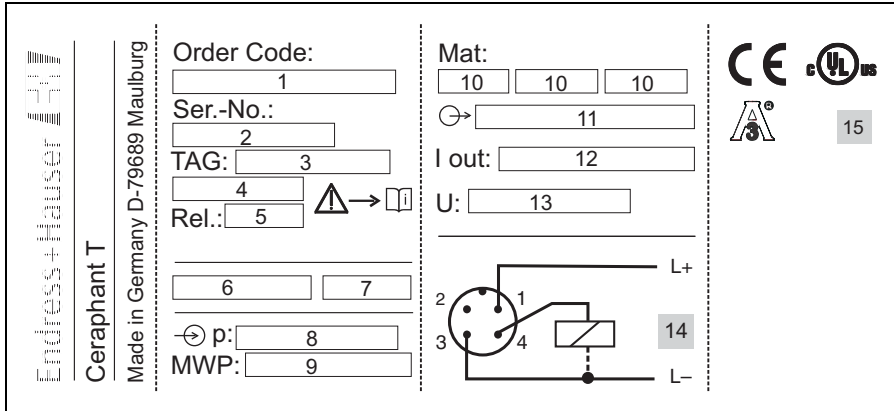

P01-PTx3xxxx-18-xx-xx-xx-001

Fig. 1: Explanation of the nameplate - see table below

1	Order code	6	Degree of protection	11	Electronics
2	Serial number	7	Degree of protection	12	Current output
3	TAG number	8	Sensor range	13	Supply voltage
4	TAG number	9	Max. operating pressure	14	Connection diagram
5	Release number (change status)	10	Wetted materials	15	Approvals



Note!

- The release number indicates the change status of the device. A change in the last two figures does not have any affect on the compatibility - see also → Chap. 9.5.
- The MWP (maximum working pressure) is specified on the nameplate. This value refers to a reference temperature of +20 °C (68 °F) and may be applied to the device for an unlimited time.
The test pressure (Over Pressure Limit OPL) corresponds to 1.5 times the MWP and may be applied for a limited time only in order to avoid lasting damage.

2.2 CE mark, declaration of conformity

The device is designed to meet state-of-the-art safety requirements, has been tested and left the factory in a condition in which it is safe to operate. The device complies with the applicable standards and regulations as listed in the EC declaration of conformity and thus complies with the statutory requirements of the EC Directives. Endress+Hauser confirms the successful testing of the device by affixing to it the CE mark.

2.3 Registered trademarks

Ceraphire®

Registered trademark of Endress+Hauser GmbH+Co.KG, Maulburg, Germany

ReadWin®

Registered trademark of Endress+Hauser Wetzlar GmbH+Co.KG, Nesselwang, Germany

LEXAN®

Registered trademark of General Electric Plastics B.V., Bergen op Zoom, Netherlands

THERMOPLAST®

Registered trademark of Kraiburg TPE GmbH, Waldkraiburg, Germany

3 Installation

3.1 Incoming acceptance, storage

- Incoming acceptance:
Check the packaging and the device for damage. Check that the goods delivered are complete and nothing is missing.
- Storage:
Storage temperature $-40\dots+85\text{ }^{\circ}\text{C}$ ($-40\text{ to }+185\text{ }^{\circ}\text{F}$)

3.2 Installation instructions

For typical possibilities for installing the Ceraphant T - see the diagram below:

- Pressure measurement in gases (left)
Mount Ceraphant T with shut-off assembly above the sampling nozzle so that any condensate can drain off into the process.
- Pressure measurement in steam (centre)
Mount Ceraphant T with U-pipe above the sampling nozzle. Fill the U-pipe with fill fluid before commissioning.
- Pressure measurement in liquids (right)
Mount Ceraphant T below or at the same level as the sampling nozzle.

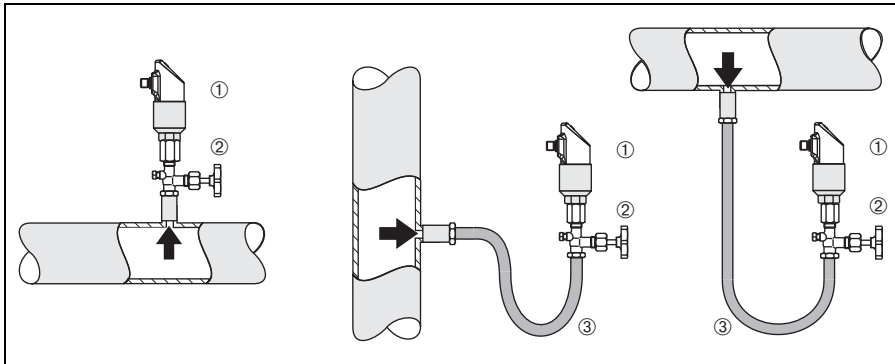

P01-PTx3xxxx-11-xx-xx-xx-001

Fig. 2: Possibilities for installing to measure pressure in gases, steam and liquids.

- ① Ceraphant T
- ② Shut-off assembly
- ③ U-pipe

3.2.1 Mounting instructions

- Do not mount the device in the product flow or at a point where it could be affected by pressure pulses
- Calibration and functional testing are easier if the device is mounted downstream of a shut-off assembly
- The orientation of the Ceraphant T can result in zero point shift, i.e. in an unpressurised state, the measured value does not display zero. This zero point shift can be corrected – see "Operation" section
- The on-site display can be rotated electronically 180° – see "Operation" section
- The housing can be rotated up to 310°
- Process connection G ½A, flush mounted, max. torque 40 Nm (29.5 lbf ft) (with PTP31)

3.3 Post-installation check

After installing the device, carry out the following checks:

- Are all screws firmly tightened?

4 Wiring

4.1 DC voltage version with M12 connector

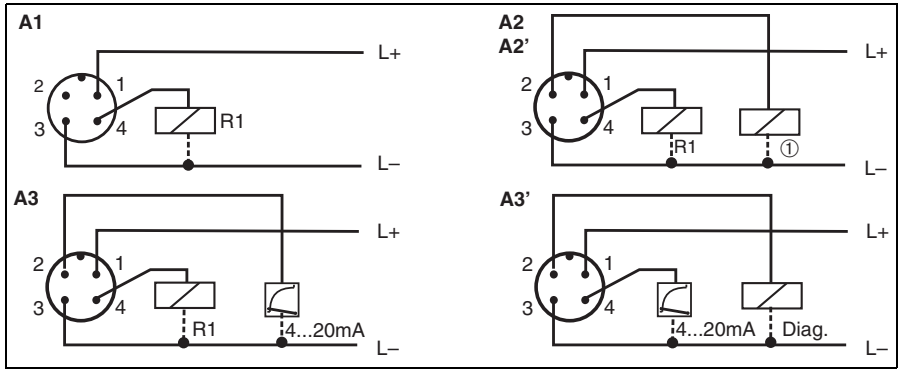

P01-PTx3xxxx-04-xx-xx-xx-002

Fig. 3: Ceraphant T with M12x1 connector

A1: 1x PNP switch output

A2: 2x PNP switch outputs R1 and R2

A2': 2x PNP switch outputs R1 and ① (diagnosis/break contact with adjustment "DESINA")

A3: PNP switch output with additional analog output

A3': PNP switch output with additional analog output (PIN assignment with "DESINA" setting)

⚠ Caution!

To avoid the analog input damaging of a PLC, do not connect the active PNP switch output of the device to the 4...20 mA input of a PLC.



Note!

DESINA (see → Chap. 6.2 Basic settings):

R2 = Diagnosis/break contact (more informations about DESINA see www.desina.de)

4.2 DC voltage version with valve connector

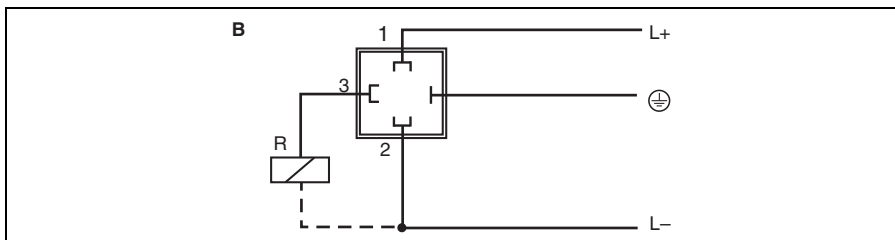

P01-PTx3xxxx-04-xx-xx-xx-003

Fig. 4: Ceraphant T with valve connector

B: 1x PNP switch output

4.3 DC voltage version with cable

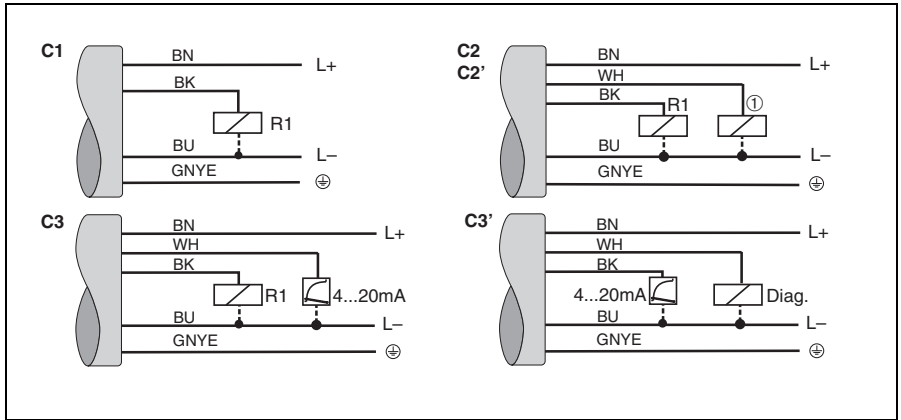

P01-PTX3xxxx-04-xx-xx-xxx-004

Fig. 5: Ceraphant T with cable connection

C1: 1x PNP switch output

C2: PNP switch outputs R1 and ① (R2)

C2': PNP switch outputs R1 and ① (diagnosis/break contact with adjustment "DESINA")

C3: PNP switch output with additional analog output

C3': PNP switch output with additional analog output (assignment with "DESINA" setting)

Cable specification: all three versions 5-core, 4 x 0.2 mm² (25 AWG), PE 0.75 mm² (18 AWG)

–Core colours: BN = brown, BK = black, WH = white, BU = blue, GNYE = green/yellow

4.4 Supply voltage

DC voltage version

12...30 V DC

4.5 Current consumption

Without load < 60 mA, with reverse polarity protection

4.6 Post-connection check

Perform the following checks after completing electrical installation of the device:

- Does the supply voltage match the specifications on the nameplate?
- Is the device connected as per → Chap. 4.1/→ Chap. 4.2/→ Chap. 4.3?
- Are all screws firmly tightened?

As soon as voltage is applied to the device, the connected on-site display lights up.

5 Operation

5.1 On-site operation

The Ceraphant T is operated by means of three keys. The digital display and the light emitting diodes (LED) support navigation in the operating menu.

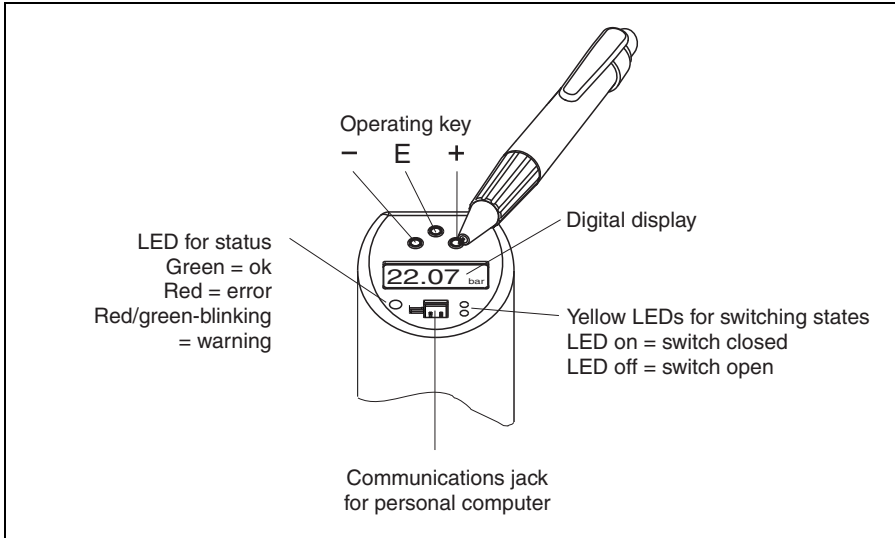

P01-PTx3xxxx-19-xx-xx-en-003

Fig. 6: Position of operating elements and possibilities for display

Background illumination of the digital display:

- White = OK status
- Red = error status

5.1.1 Navigating in the operating menu

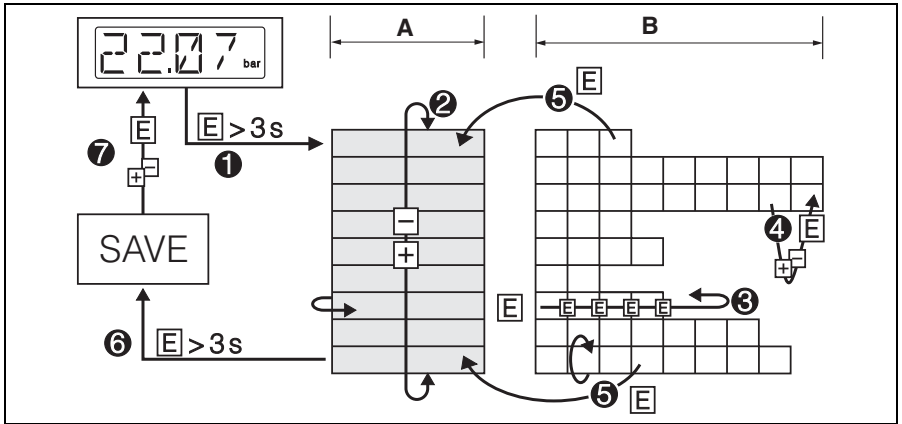

P01-PTx3xxxx-19-xx-xx-xx-005

Fig. 7: Navigating in the operating menu

A Function group selection

B Function selection

- ① Enter the operating menu
– press the E key for longer than 3 s
- ② Select the "Function group" with the + or - key
- ③ Select the "Function" with the E key
- ④ Enter or change parameters with the + or - key
– then return to "Function" with the E key Note: If software locking is enabled, it must be disabled before making entries or changes by entering the code selected
- ⑤ Press the E key several times to return to the "Function group"
- ⑥ Jump back to the measuring position (Home position)
– press the E key for longer than 3 s
- ⑦ Query to save data (select "YES" or "NO" with the + or - key)
– confirm with the E key



Note!

Changes to the parameter settings only become effective if you choose ⑦ "YES" when asked to save data.

5.1.2 Structure of the operating menu

The structure below shows all the possible fields of the operating menu.

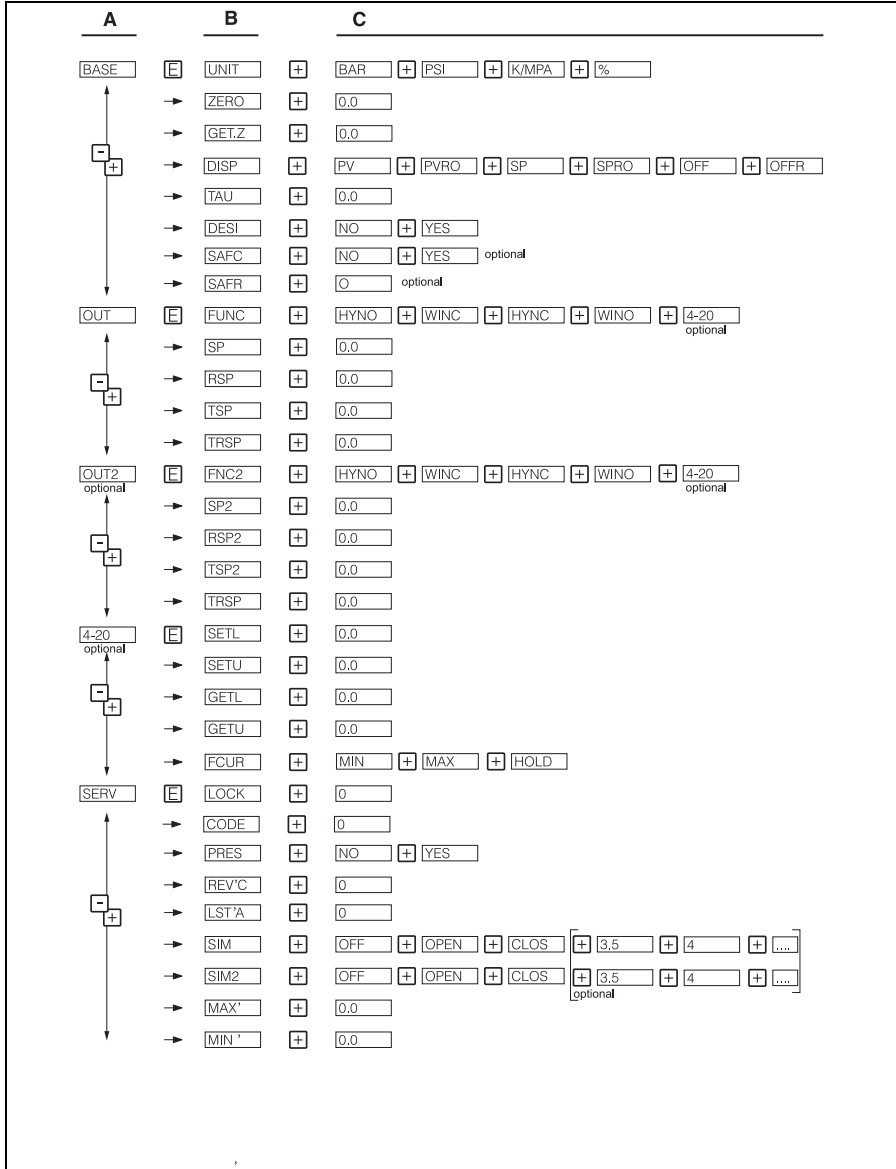
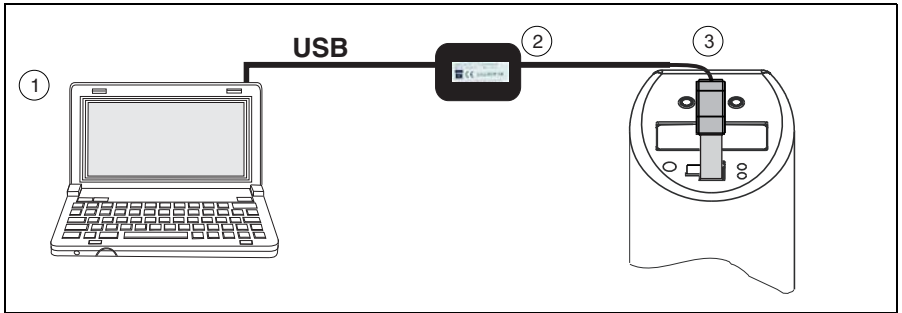

Fig. 8: Operating menu: A function groups, B functions, C settings

P01-PTx3xxxx-19-xx-xx-xx-100

5.2 Operation with personal computer

The device can be configured with the configuration software ReadWin® 2000 or FieldCare. For the connection between the USB port of the computer and the device a configuration kit (e.g. TXU10 or FXA291) is necessary.



P01-PTx3xxxx-19-xx-xx-xx-004

Fig. 9: Operation with PC

- ① Personal computer with configuration software ReadWin 2000 or FieldCare
- ② Configuration kit (USB interface) TXU10-AA or FXA291 with USB connection
- ③ Ceraphant T with communication jack

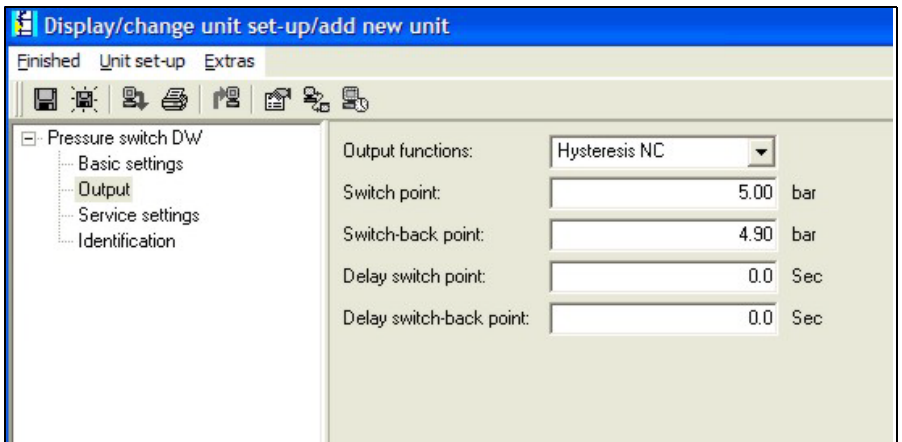

Fig. 10: Device configuration with ReadWin

5.2.1 Additional operating options

In addition to the operating options listed in the previous "On-site operation" section, the ReadWin 2000 or FieldCare configuration software provides further information on the Ceraphant T:

Function group	Description
SERV	Number of switch changes for output 1
	Number of switch changes for output 2
	Device status
	Last error to occur
INFO	Tag number
	Order code
	Limit switch serial number
	Sensor serial number
	Electronics serial number
	Device release (change status)
	Hardware version
	Software version

5.2.2 Operating Instructions for ReadWin

Comprehensive information on the ReadWin configuration software may be found in the Operating Instructions BA00137R/09/en (refer to www.readwin2000.com).

5.2.3 Operating Instructions for FieldCare

FieldCare is an universal configuration software based on FDT/DTM technology.



Note!

- To configure the Ceraphant T with FieldCare the "PCP (ReadWin) Communication DTM" and the Ceraphant T device-DTM are required.
- All devices with software version 1.01.00 or higher can be configured with FieldCare.
- The device supports only offline configuration and up-/download of parameters. The online configuration is not supported.
- Detailed information concerning FieldCare may be found in the operation manual BA00027S or see: www.endress.com.

6 Commissioning

6.1 Function check

Carry out a post-installation and a post-connection check as per the checklist before commissioning the device.

- "Post-installation check" see → Chap. 3.3 checklist
- "Post-connection check" see → Chap. 4.6 checklist

6.2 Basic settings

Base	Basic settings		
BASE	UNIT	Technical unit	<div style="display: flex; flex-direction: column; gap: 5px;"> <div style="border: 1px solid black; padding: 2px; width: 60px; text-align: center;">BAR</div> <div style="border: 1px solid black; padding: 2px; width: 60px; text-align: center;">PSI</div> <div style="border: 1px solid black; padding: 2px; width: 60px; text-align: center;">KPA</div> <div style="border: 1px solid black; padding: 2px; width: 60px; text-align: center;">%</div> </div> <p>Select technical unit: bar psi kPa/MPa %</p>
	ZERO	Configure zero point	<div style="border: 1px solid black; padding: 2px; width: 60px; text-align: center;">0.0</div> <p>Offset: ±20 % URL</p>
	GET.Z	Accept zero point	<div style="border: 1px solid black; padding: 2px; width: 60px; text-align: center;">0.0</div> <p>Current value as zero point (Offset max. ±20 % URL)</p>
	DISP	Display	<div style="display: flex; flex-direction: column; gap: 5px;"> <div style="border: 1px solid black; padding: 2px; width: 60px; text-align: center;">PV</div> <div style="border: 1px solid black; padding: 2px; width: 60px; text-align: center;">PVRO</div> <div style="border: 1px solid black; padding: 2px; width: 60px; text-align: center;">SP</div> <div style="border: 1px solid black; padding: 2px; width: 60px; text-align: center;">SPRO</div> <div style="border: 1px solid black; padding: 2px; width: 60px; text-align: center;">OFF</div> <div style="border: 1px solid black; padding: 2px; width: 60px; text-align: center;">OFFR</div> </div> <p>PV ¹⁾: measured value display PVRO: measured value display rotated 180° SP: set switch point display SPRO: set switch point display rotated 180° OFF: display off OFFR: display off rotated 180°</p>
	TAU	Damping: display value, output signal	<div style="border: 1px solid black; padding: 2px; width: 60px; text-align: center;">0.0</div> <p>0...40 s in increments of 0.1 s</p>
	DESI	DESINA	<div style="display: flex; flex-direction: column; gap: 5px;"> <div style="border: 1px solid black; padding: 2px; width: 60px; text-align: center;">NO</div> <div style="border: 1px solid black; padding: 2px; width: 60px; text-align: center;">YES</div> </div> <p>Connection in accordance with DESINA guidelines (see → Chap. 4)</p>

Base	Basic settings
 Note! The percentage specification applies to the upper range limit.	

- 1) Factory setting

6.3 Output setting

- Hysteresis function: The hysteresis function enables two-point control via a hysteresis. Depending on the pressure p , the hysteresis can be set via the switch point SP and the switch-back point RSP.
- Window function: Enables the monitoring of a process pressure range. The hysteresis of the switch points SP and RSP is less than 0.1 % URL. Under rough EMC-conditions quick switching is possible if the measured value is near to SP or RSP. Setting a damping of 0.1 s will avoid this effect.
- NO contact or NC contact: This switch function is freely selectable.
- Factory setting (if no customer-specific settings have been ordered):
 Switch point SP 1: 45 %; Switch-back point RSP 1: 44.5 %
 Switch point SP 2: 55 %; Switch-back point RSP 2: 54.5 %
 Analog output: LRV 0 %; URV 100 %
- Range of adjustment: LRL = Lower Range Limit; URL = Upper Range Limit;
 LRV = Lower Range Value; URV = Upper Range Value

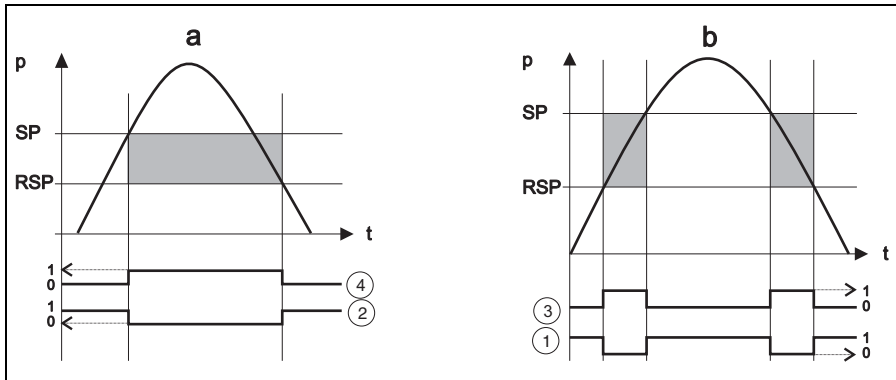

P01-PTx3xxxx-05-xx-xx-xx-001

Fig. 11: a) Hysteresis function
 b) Window function
 ① Windows NC contact switch status
 ② Hysteresis NC contact switch status
 ③ Windows NO contact switch status
 ④ Hysteresis NO contact switch status
 SP switch point
 RSP switch-back point

OUT/OUT2	Output/output 2		
<div style="border: 1px solid black; padding: 2px; margin-bottom: 5px;">OUT</div> <div style="border: 1px solid black; padding: 2px;">OUT2</div>	<div style="border: 1px solid black; padding: 2px; margin-bottom: 5px;">FUNC</div> <div style="border: 1px solid black; padding: 2px;">FNC2</div>	Switching characteristic	<div style="border: 1px solid black; padding: 2px; margin-bottom: 5px;">HYNO</div> <div style="border: 1px solid black; padding: 2px; margin-bottom: 5px;">HYNC</div> <div style="border: 1px solid black; padding: 2px; margin-bottom: 5px;">WIND</div> <div style="border: 1px solid black; padding: 2px; margin-bottom: 5px;">WINC</div> <div style="border: 1px solid black; padding: 2px;">4--20</div> <p>HYNO ¹⁾: Hysteresis/NO contact HYNC: Hysteresis/NC contact WIND: Window/NO contact WINC: Window/NC contact 4...20 mA: Analog output (only if available)</p>
	<div style="border: 1px solid black; padding: 2px; margin-bottom: 5px;">SP</div> <div style="border: 1px solid black; padding: 2px;">SP2</div>	Switch point value	<div style="border: 1px solid black; padding: 2px; margin-bottom: 5px;">0.0</div> <div style="border: 1px solid black; padding: 2px;">0.0</div> <p>Switch point 0.5...100 % URL in increments of 0.1 % of selected unit (min. 0.001 bar (0.015 psi))</p>
	<div style="border: 1px solid black; padding: 2px; margin-bottom: 5px;">RSP</div> <div style="border: 1px solid black; padding: 2px;">RSP2</div>	Switch-back point value	<div style="border: 1px solid black; padding: 2px; margin-bottom: 5px;">0.0</div> <div style="border: 1px solid black; padding: 2px;">0.0</div> <p>Switch-back point 0...99.5 % URL in increments of 0.1 % of selected unit (min. 0.001 bar (0.015 psi))</p>
	<div style="border: 1px solid black; padding: 2px; margin-bottom: 5px;">TSP</div> <div style="border: 1px solid black; padding: 2px;">TSP2</div>	Switch point delay	<div style="border: 1px solid black; padding: 2px; margin-bottom: 5px;">0.0</div> <div style="border: 1px solid black; padding: 2px;">0.0</div> <p>Delay time 0...99 s in increments of 0.1 s</p>
	<div style="border: 1px solid black; padding: 2px; margin-bottom: 5px;">TRSP</div> <div style="border: 1px solid black; padding: 2px;">TRSP2</div>	Switch-back point delay	<div style="border: 1px solid black; padding: 2px; margin-bottom: 5px;">0.0</div> <div style="border: 1px solid black; padding: 2px;">0.0</div> <p>Delay time 0...99 s in increments of 0.1 s</p>
<p> Note!</p> <ul style="list-style-type: none"> ■ Adjustment of measuring ranges with negative gauge pressure up to 4 bar (60 psi) in increments of min. 0.01 mbar (0.15 psi). ■ Min. distance between SP and RSP: 0.5% URL 			

1) Factory setting

4 - 20	Analog output			
4 -- 20	SETL	Value for 4 mA (LRV)	<input type="text" value="0.0"/>	Enter lower range value in increments of 0.1 % of selected unit
	SETU	Value for 20 mA (URV)	<input type="text" value="0.0"/>	Enter upper range value in increments of 0.1 % of selected unit
	GETL	Pressure applied for 4 mA (LRV)	<input type="text" value="0.0"/>	Take pressure value as lower range value
	GETU	Pressure applied for 20 mA (URV)	<input type="text" value="0.0"/>	Take pressure value as upper range value
	FCUR	Error current	MIN' MAX' HOLD	Current value in event of error: MIN = ≤3.6 mA MAX ¹⁾ = ≥21.0 mA HOLD = last value
 Note! Turndown up to 4:1, LRV must be lower than URV				







1) Factory setting

6.4 Service function setting

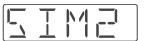
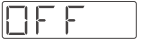
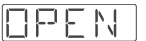
■ Locking code

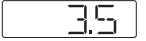
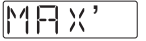
A locking code already assigned can only be changed by first entering the old code for enabling the device.

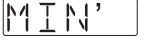
SERV	Service functions			
SERV	LOCK	Security locking	<input type="text" value="0"/>	Locking against undesired configuration
	CODE	Locking code	<input type="text" value="0"/>	Freely selectable code 1...9999 0 = no locking
	PRES	Reset	NO YES	Reset all entries to the factory setting
	REVC	Revision counter	<input type="text" value="0"/>	Increases by 1 with each configuration
	LSTA	Last device status	<input type="text" value="0"/>	Displays the last device status to occur ≠0

SERV	Service functions			
	 	Simulation output 1 or 2	   	OFF: No simulation OPEN: Switch output open CLOS: Switch output closed 3.5: Simulation values for analog output in mA (3.5/4.0/8.0/12.0/16.0/20.0/21.7)
		Max. indicator		Display of max. measured process value
		Min. indicator		Display of min. measured process value

7 Maintenance

Ceraphant T requires no maintenance.

7.1 Exterior cleaning

Please note the following points when cleaning the device:

- The cleaning agents used should not attack the surface and the seals.
- Mechanical damage to the process isolating diaphragm, e.g. due to pointed objects, must be avoided.
- Observe degree of protection. See therefor nameplate if necessary (Page 4).

8 Accessories

8.1 Process connection

- Ceraphant T PTC31:
The sensor module and the process connection are connected together and cannot be separated.
- Ceraphant T PTP31, PTP35:
The process connection is an adapter and the sensor module has an adapter thread. As a result, the process connection can easily be changed at a later stage.
Exceptions:
Process connection G ½A flush mounted, Clamp ½ and G 1A and 400 bar (6000 psi) sensors.

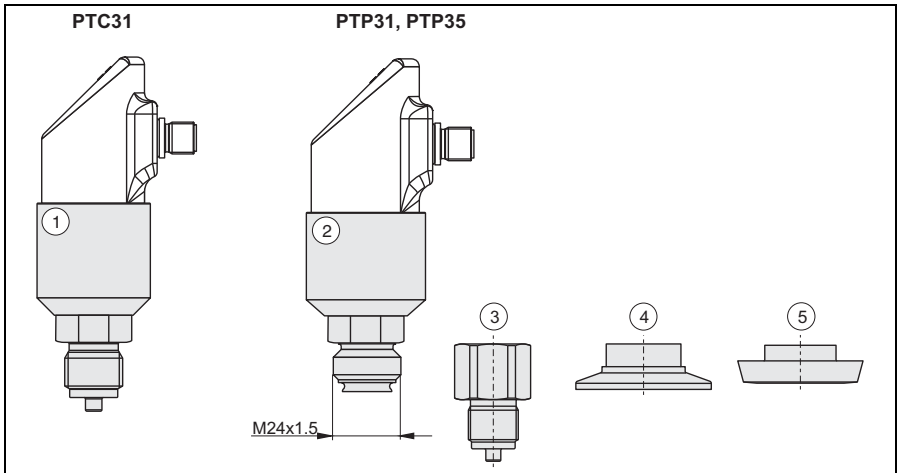

P01-PTx.3xxxx-06-xx-xx-xx-006

Fig. 12: Process connection

- ① Sensor module PTC31
- ② Sensor module PTP31 and PTP35
- ③ Adapter with threaded connection (apart from G ½A flush mounted)
- ④ Adapter with Clamp connection (apart from Clamp ½")
- ⑤ Adapter with hygiene connection (apart from G 1A)

8.1.1 Adapter change

The adapter can be changed on PTP31 and PTP35.

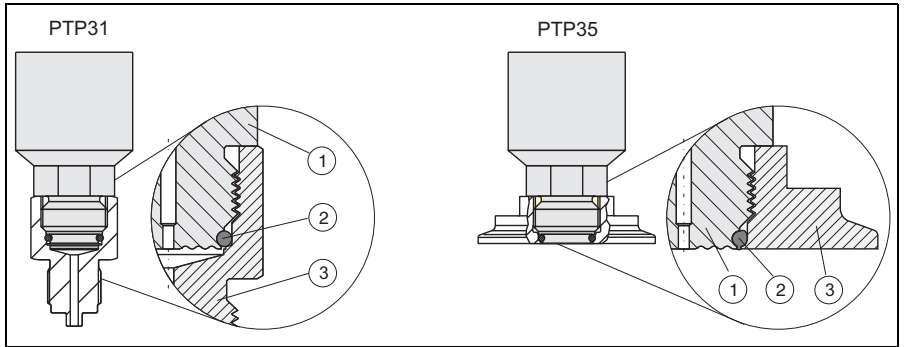

P01-PTx3xxxx-17-xx-xx-xx-001

Fig. 13: Changing the adapter

- ① Sensor module with adapter thread
- ② Standard O-ring
- ③ Adapter

Please note the following when changing the adapter:

- Use a new O-ring. Diameter 15.54 (0.61 in) x 2.62 mm (0.1 in).
With either EPDM 70 Shore FDA or FKM 70 Shore material.
- The device (sensor module) can be fixed in place with an open-ended wrench AF 27mm.
- The adapter can be screwed on with an open-ended wrench AF 28mm or AF 32mm (depending on the process connection).
The maximum torque is 80 Nm (59 lbs ft). The thread can become loose if exposed to severe strain through pressure and temperature. For this reason, the air-tightness must be checked regularly and the thread tightened if necessary.
- When changing the adapter, make sure that the process isolating diaphragm of the sensor is not damaged.



Note! O-ring change:

We recommend to change the O-ring in the same time frame as of all other sealings in your process.

8.1.2 Adapter versions

- PTP31: order numbers for thread adapter versions.
 - Version AC: order no. 52023980
 - Version AD: order no. 52023981
 - Version AE: order no. 52023982
 - Version AF: order no. 52023983
 - Version BA: order no. 52023984
 - Version CA: order no. 52023985
 - Version DA: order no. 52023986
 - Version DD: order no. 52023987

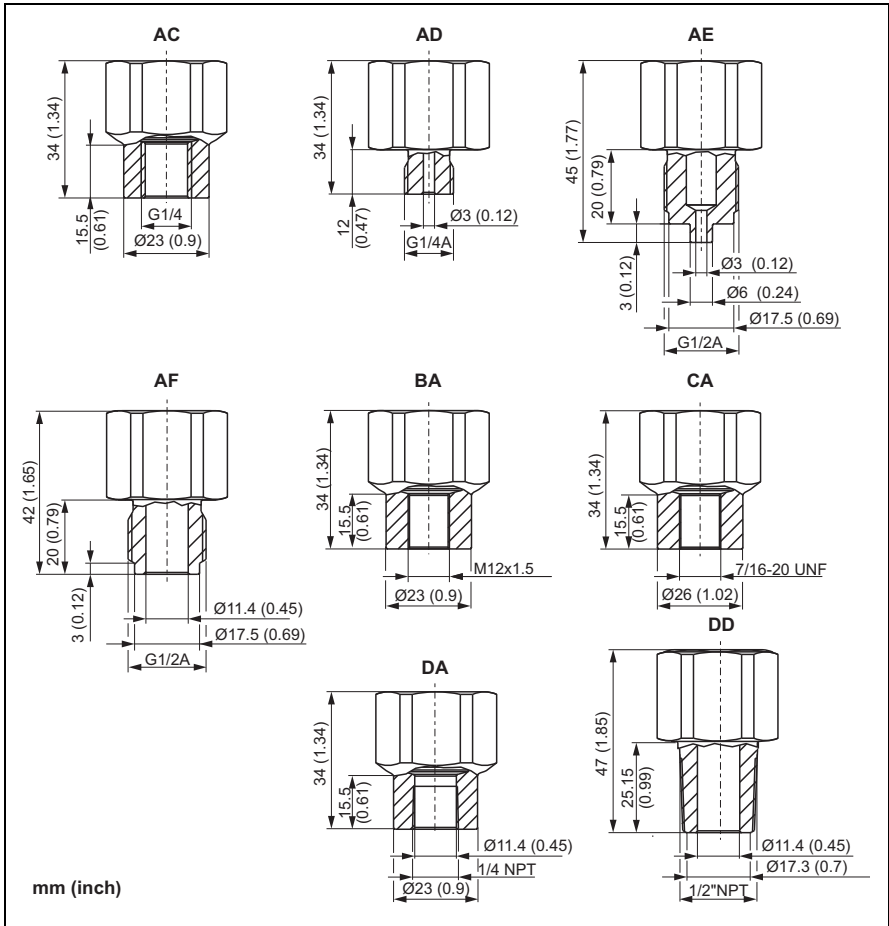

P01-PTx3xxxx-00-xx-xx-xx-020

- PTP35: order numbers for Clamp adapter versions.

Version DB: order no. 52023994

Version DL: order no. 52023995

Optional with inspection certificate 3.1:

Version DB: order no. 52024001

Version DL: order no. 52024002

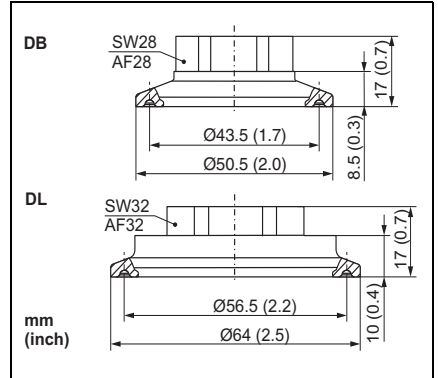

P01-PTx3xxxx-06-xx-xx-xx-009

- PTP35: order numbers for hygiene adapter versions.

Version LB: order no. 52023996

Version LL: order no. 52023997

Version PH: order no. 52023999

Version PL: order no. 52023998

Version HL: order no. 52024000

Version KL: order no. 52026997

Optional with inspection certificate 3.1:

Version LB: order no. 52024003

Version LL: order no. 52024004

Version PH: order no. 52024006

Version PL: order no. 52024005

Version HL: order no. 52024007

Version KL: order no. 52026999

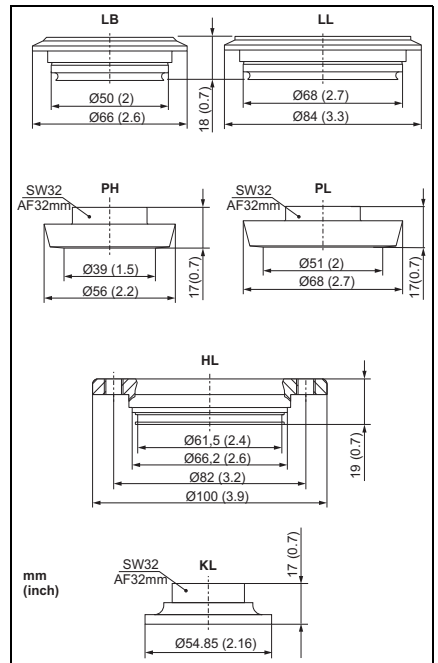

P01-PTx3xxxx-06-xx-xx-xx-010

8.1.3 O-ring for adapter change

- O-ring 15.54 x 2.62 mm (0.61 x 0.1 in), EPDM 70 Shore FDA, order number 52024267
- O-ring 15.54 x 2.62 mm (0.61 x 0.1 in), FKM 70 Shore, order number 52024268

8.2 Welding bosses

8.2.1 Welding boss with sealing taper

- Welding boss for flush mounting process connection G1A with metallic sealing taper (version BA for PTP35)
Material: AISI 316L
Order number: 52005087
- Optional with inspection certificate 3.1
Order number: 52010171
- Welding aid (Dummy) for welding the welding boss without any problems, order number 52005087 or 52010171
Material: brass
Order number: 52005272

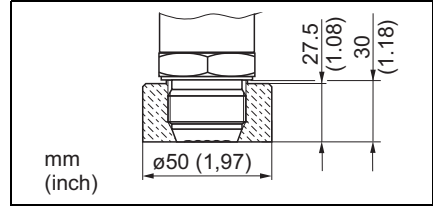

P01-Pxxxxxxx-00-xx-00-xx-001

8.2.2 Welding boss with sealing surface

- Welding boss for flush mounting process connection G1 A (ISO 228) with sealing surface (version BB for PTP35)
Material: AISI 316L
Order number: 52001051
- Seal (enclosed): silicone O-ring
FDA approved materials according to 21 CFR Part 177.1550/2600
- Optional with inspection certificate 3.1
Order number: 52011896

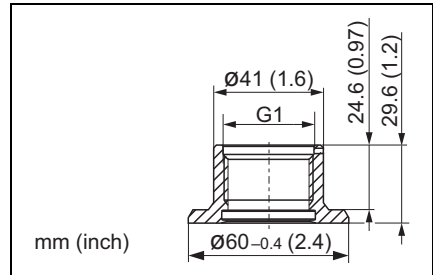

P01-PMP13xxx-00-xx-00-xx-002

8.3 Electrical connection

8.3.1 Plug-in jack, connecting cable

- M12x1 plug-in jack. Connection to M12x1 housing connector
 Materials: Body PA, coupling nut Cu Zn, brass, nickeled.
 Protection: IP 67 (fully locked).
 Order number: 52006263

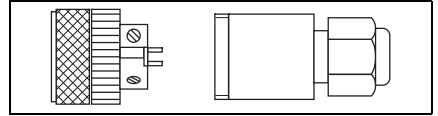

P01-PMP13xxx-00-xx-00-xx-003

- M12x1 plug-in jack, elbowed
 Connection to M12x1 housing connector
 Materials: Body PBT/PA, coupling nut GD-Zn, brass, nickeled
 Protection: IP 67 (fully locked)
 Order number: 51006327

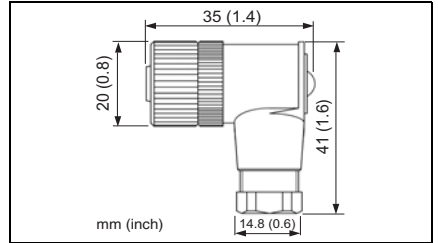

P01-Pxxxxxx-00-xx-00-xx-002

- Cable, 4 x 0.34 mm² (22 AWG) with M12 socket, elbowed, screw plug, length 5 m (16 ft)
 Materials: Body PUR; coupling nut Cu Zn/Ni, brass, nickeled; cable: PVC
 Protection: IP 67 (fully locked)
 Order number: 52010285
- Cable, 4 x 0.34 mm² (22 AWG) with M12 socket, with LED, elbowed, screw plug, PVC cable. For devices with switch output only.
 Materials: Body PVC, coupling nut 316L,
 Protection: IP 69K (fully locked)
 Order number: 52018763

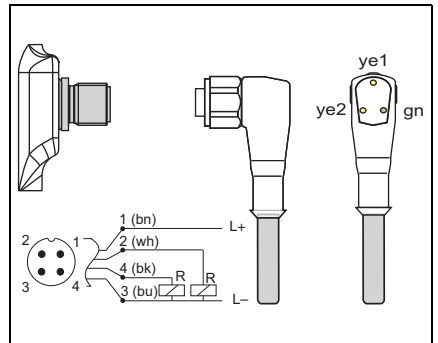

P01-PTx3xxxx-07-xx-xx-xx-001

8.4 ReadWin

- Configuration kit for PC-programmable transmitters. Setup program and interface cable for PCs with USB port. Adapter for transmitters with 4-pin post connector. Order code: TXU10-AA
- ReadWin® 2000 is supplied with the configuration kit or it can be downloaded free of charge directly from the internet at the following address:
www.readwin2000.com

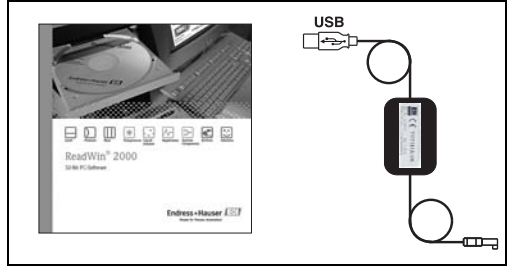

9 Trouble-shooting

9.1 Errors and warnings

If an error in the device occurs, the colour of the status LED changes from green to red and the background illumination of the digital display changes from blue to red. The measured value and message are displayed alternately. The display shows:

- E-code for errors. In the event of error messages, the measured value is uncertain.
- W-code for warnings. In the event of a warning, the measured value is reliable.

E-Code	Explanation	Remedy
E011	Device configuration defective	Reset device (see → Chap. 6.4)
E012	Error in measurement or pressure out of specification	Check pressure, return device to Endress+Hauser where necessary
E019	Power supply outside specification	Check operating voltage
E015	Memory error	Return device to Endress+Hauser
E020		
E021		
E022	Power is only supplied to the device via the communication interface (measurement is deactivated)	Check operating voltage
E025	Switching contact 1 is not open although it should be	Switching contact defective. Return device to Endress+Hauser
E026	Switching contact 2 is not open although it should be	Switching contact defective. Return device to Endress+Hauser
E040	VCC (controller voltage) is out of working area	Return device to Endress+Hauser
E042	Output current can no longer be generated (only for 4 to 20 mA output, e.g. load at analog output too high or open analog output)	Check load; switch off analog output via configuration if it isn't required (see → Chap. 6.3)
E044	Output current drifts too much (± 0.5 mA)	Return device to Endress+Hauser

W-Code	Explanation	Remedy
W107	Simulation active	Switch off the output simulation for output 1 and output 2
W202	Pressure outside the sensor range	Operate the device in the specified pressure range
W209	Device starts	
W210	Configuration modified (warning code will be displayed for 15 s approx.)	

W-Code	Explanation	Remedy
W212	Sensor signal outside the permitted range	Operate the device in the specified pressure range
W250	Number of switch cycles exceeded	Replace the device
W270	Short-circuit and overload at output 1	Check output wiring. Extend the load resistance at output 1
W280	Short-circuit and overload at output 2	Check output wiring. Extend the load resistance at output 2

9.2 Repair

A repair is not planned.

9.3 Return

The following procedures must be carried out before a device is send to Endress+Hauser:

- Always enclose a fully completed “Declaration of Contamination” form with the device. Only then can Endress+Hauser transport and examine a returned device. A copy of the “Declaration of Contamination” can be found on the second last page of these Operating Instructions.
- Remove all fluid residues. This is particularly important if the fluid is hazardous to health, e.g. flammable, toxic, caustic, carcinogenic, etc.



Warning!

Do not return a measuring device if you are not absolutely certain that all traces of hazardous substances have been removed, e.g. substances which have penetrated crevices or diffused through plastic.

9.4 Disposal

When disposing, ensure that the materials of the device components are separated and processed accordingly.

9.5 Change status (release)

The release number on the nameplate and in the Operating Instructions indicates the change status of the device: X.YY. (example 1.02.).

- X Change in the main version.
Compatibility no longer provided. Device and Operating Instructions change.
- YY Compatibility provided. Operating Instructions change.

9.6 Change status - history

Release no. device	Changes
1.00	
1.01	New analog electronics
1.02	Modification sensor units
1.03	Internal device modification
1.04	Internal device modification
1.05	Internal device modification

10 Technical data

For technical data, please refer to the Technical Information Ceraphant T TI00384P.

Index**A**

Adapter change	21
Adapter versions	22
Additional operating options	14

M

Mounting instructions	7
---------------------------------	---

N

Navigating in the operating menu	11
--	----

O

Operating Instructions for FieldCare	14
Operating Instructions for ReadWin	14
O-ring for adapter change	23

P

Plug-in jack, connecting cable	25
--	----

S

Structure of the operating menu	12
---	----

W

Welding boss with sealing surface	24
Welding boss with sealing taper	24

Declaration of Hazardous Material and De-Contamination
Erklärung zur Kontamination und Reinigung

RA No.

Please reference the Return Authorization Number (RA#), obtained from Endress+Hauser, on all paperwork and mark the RA# clearly on the outside of the box. If this procedure is not followed, it may result in the refusal of the package at our facility.
Bitte geben Sie die von E+H mitgeteilte Rücklieferungsnummer (RA#) auf allen Lieferpapieren an und vermerken Sie diese auch außen auf der Verpackung. Nichtbeachtung dieser Anweisung führt zur Ablehnung Ihrer Lieferung.

Because of legal regulations and for the safety of our employees and operating equipment, we need the "Declaration of Hazardous Material and De-Contamination", with your signature, before your order can be handled. Please make absolutely sure to attach it to the outside of the packaging.

Aufgrund der gesetzlichen Vorschriften und zum Schutz unserer Mitarbeiter und Betriebseinrichtungen, benötigen wir die unterschriebene "Erklärung zur Kontamination und Reinigung", bevor Ihr Auftrag bearbeitet werden kann. Bringen Sie diese unbedingt außen an der Verpackung an.

Type of instrument / sensor
Geräte-/Sensortyp _____

Serial number
Seriennummer _____

Used as SIL device in a Safety Instrumented System / Einsatz als SIL Gerät in Schutzeinrichtungen

Process data / Prozessdaten

Temperature / Temperatur _____ [°F] _____ [°C] Pressure / Druck _____ [psi] _____ [Pa]
Conductivity / Leitfähigkeit _____ [µS/cm] Viscosity / Viskosität _____ [cp] _____ [mm²/s]

Medium and warnings

Warnhinweise zum Medium



	Medium /concentration Medium /Konzentration	Identification CAS No.	flammable entzündlich	toxic giftig	corrosive ätzend	harmful/ irritant gesundheitsschädlich/ reizend	other * sonstiges*	harmless unbedenklich
Process medium Medium im Prozess								
Medium for process cleaning Medium zur Prozessreinigung								
Returned part cleaned with Medium zur Endreinigung								

* explosive; oxidising; dangerous for the environment; biological risk; radioactive
* explosiv; brandfördernd; umweltgefährlich; biogefährlich; radioaktiv

Please tick should one of the above be applicable, include safety data sheet and, if necessary, special handling instructions.
Zutreffendes ankreuzen; trifft einer der Warnhinweise zu, Sicherheitsdatenblatt und ggf. spezielle Handhabungsvorschriften beilegen.

Description of failure / Fehlerbeschreibung _____

Company data / Angaben zum Absender

Company / Firma _____	Phone number of contact person / Telefon-Nr. Ansprechpartner: _____
Address / Adresse _____	Fax / E-Mail _____
Your order No. / Ihre Auftragsnr. _____	

"We hereby certify that this declaration is filled out truthfully and completely to the best of our knowledge. We further certify that the returned parts have been carefully cleaned. To the best of our knowledge they are free of any residues in dangerous quantities."

"Wir bestätigen, die vorliegende Erklärung nach unserem besten Wissen wahrheitsgetreu und vollständig ausgefüllt zu haben. Wir bestätigen weiter, dass die zurückgesandten Teile sorgfältig gereinigt wurden und nach unserem besten Wissen frei von Rückständen in gefährlicher Menge sind."

PSP/Konza XV

(place, date / Ort, Datum)

Name, dept./ Abt. (please print / bitte Druckschrift)

Signature / Unterschrift

www.endress.com/worldwide

Endress+Hauser 
People for Process Automation

KA00225P/00/EN/14.11
71137689
FM+SGML 6.0

