

RX8/00-1A

cubic photosensors



Micro Detectors

Italian Sensors Technology

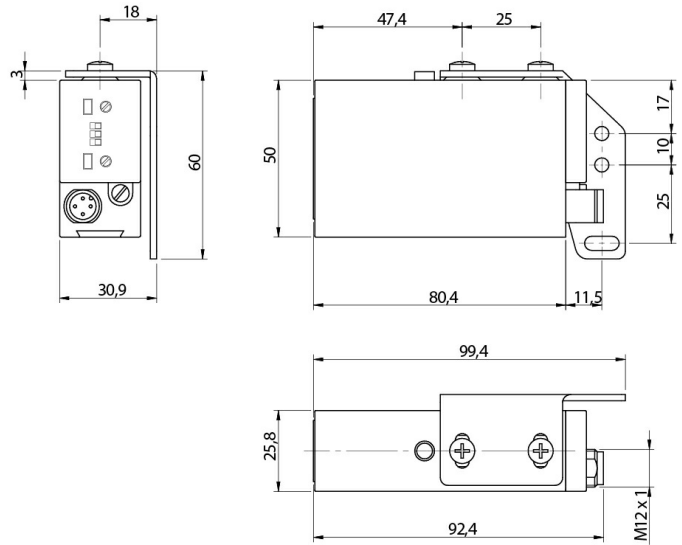

Indicative image



Detection properties

Nominal sensing distance	2m with white matt paper EG=1,5
Thermal drift of Sr	10% Sr
Repeat Accuracy	5%
Sensitivity adjustment	Single-turn potentiometer

Application

Function Principle	Diffuse reflection (long distance, >600mm)
Optic position	Axial

Outputs

Output type	Decout NPN/PNP Selectable
Output Function	Decout NO/NC Selectable
Switching frequency	500Hz

Electrical data

Operating Voltage	10...30Vdc
No-Load supply current	25mA
Load current	≤ 100mA
Leakage current	≤ 10μA
Output voltage drop	≤ 1,2V
Max ripple content	≤ 10%
LED indicators	Rear red (output state), superior red (alignment), green (stable signal)
Time delay before availability	100ms
Short-circuit protection	Yes
Reverse Polarity Protection	Yes
Emission	Infrared (880nm)
Interference to external light	≥ 5000lux (incandescent lamp)

Mechanical data

Dimensions	26x86,6x50
Weight	75g
Connections	M12 plug
Operating temperature	- 25°C...+ 70°C (without freeze)
Diameter/Dimension	Cubic

Test/Approvals

Approvals	CE
EMC compatibility	EN 60947-5-2
Shocks and vibrations	Vibration IEC 60068-2-6 / Shock IEC 60068-2-28
Degree of protection	IP65

Accessories

Supplied Accessories	ST80 mounting bracket and screws
----------------------	----------------------------------

ELECTRICAL DIAGRAMS OF THE CONNECTIONS

NPN

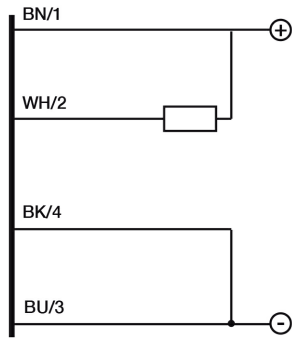

PNP

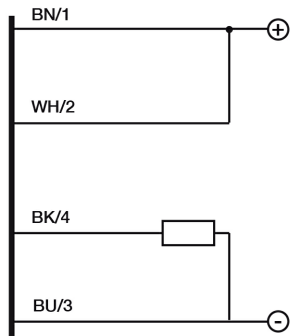

CONNECTOR

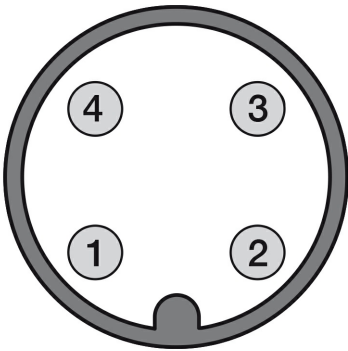

RESPONSE CURVES

Dimensione Spot

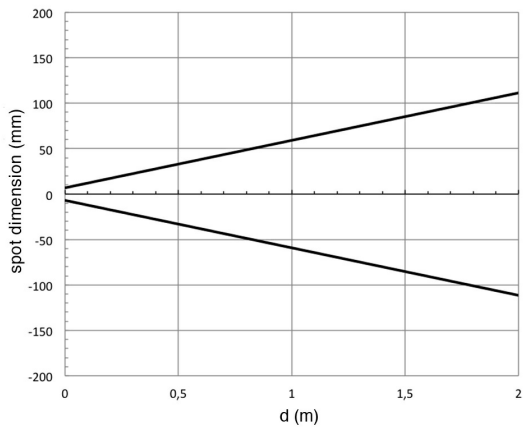

Disassamento Parallelo

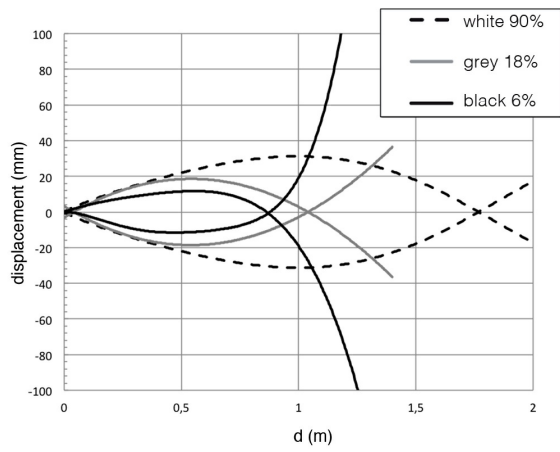

Eccesso di Guadagno

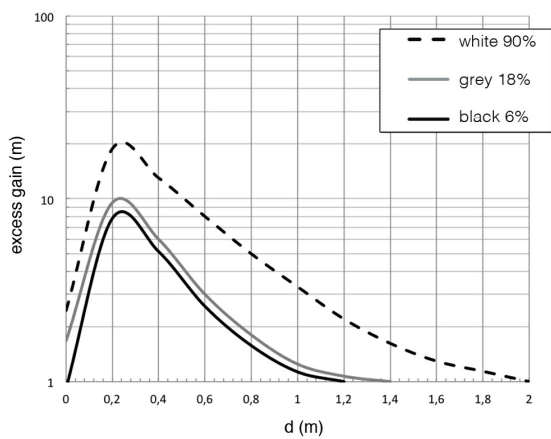

Fax 059 253973

E-mail info@microdetectors.com