



# Uplifting Quality & Service!



THE ULTIMATE



Workshop Essentials 2020.1







## THE DRIVING FORCE BEHIND:



# Lifting & handling solutions since 2002

## Reaching new heights

Winntec (Est. 2002) is a manufacturer, esteemed developer and international supplier of high quality, efficient and reliable automotive workshop “essentials”, available in automotive and industrial markets in Europe, North America, Southern Africa and Pacific Asia. The ranges are “priced right” and backed up by outstanding customer service and support.

## Our mission

Build the best products! Their quality, safety and ease of use are – and remain – at the heart of our operations.

## Our vision

Lifting, handling and transportation, that’s exactly where our focus needs to be the next years. We recognize the challenges that the mechanics (both in the shops and on the road) are experiencing. Heavy objects (vehicles & parts) will grow in number and we see it as a responsibility to bring affordable problem solvers that will save time and greatly reduce the risk of injuries.

## Our history

We decided to rebuild the hydraulic floor jack from scratch. The result was an all new, service friendly design that showed a clever mix between superb American and European characteristics and functionality. Turbo Lift and Auto Shift are just two of the amazing technologies that Winntec introduced ever since.

## Our achievements

Meanwhile, our products find their way to more than 60 countries worldwide! It are (premium) car dealerships, tire service specialists and transport companies that use our products day in, day out. Our patented Smart Car was one of the three finalists during the innovation award competition at Frankfurt Automechanika.

## Our approval

Winntec products are designed and manufactured in compliance with NEN-EN 1494:2001+A1:2008 CE

## FOR FURTHER INFORMATION AND CONTACT VISIT [WINNTEC.NET](http://WINNTEC.NET)

No rights can be derived from the contents of this folder. Images shown may differ from reality. Print and text errors reserved. \* Excludes wear and tear.





# Wheel Service

## Y471147 HD Smart Cart

Finally there's a product that really does the job! This long life, light weight, high capacity cart allows the tire fitter to maneuver heavy wheel sets in the most ergonomic way with the help of its **patented tilting system**. The unique push-slide-secure automatic locking system eliminates the need for inefficient, wear sensitive, foot operated - or hand controlled jaws.

The light yellow colored foam filled tires are maintenance free and leave no traces on the work shop floor. The cart has been developed in partnership with some of Europe's leading tire service chains. It comes in powdercoated steel (robotic welding) with high strength components and an exceptional 3 year warranty period. With just 20kg this lightweight cart handles most car and SUV wheelsets from 14" - 20" up to 200kg.



### Main features

- Superior ergonomics
- Flat-free tires leave no stripes
- Handles tires and wheel assemblies

### Specifications

<b>Height</b> =	1385 mm
<b>Width</b> =	610 mm
<b>Depth</b> =	695 mm
Max load	200 kg
Net weight	23,3 kg



WATCH DEMO



Undisputed choice of the professional

## Y4711SPP Extender & Push Pull Kit

Extend the height of your Smart Cart with the retro-fit extender. The push Pull lever ensures a quick release on smooth, polished floor or when dealing with a light stack of tires.



## Y472270 Wheel Assist ERGO+

Best in combination with 2-post and other high rise lifts. Allows operator to install wheels at chest height. Delivered with quick install ramp, foot step and sliding rollers that ensure a safe working distance from the vehicle.

Operating as a standalone piece of workshop equipment, that doesn't require charging or linking up to a power source, the Winntec® Wheel Assist has powerful gas springs that enable workshop technicians to quickly and easily remove and replace wheels while in an ergonomically correct position (chest height). This unique, patent pending product, guarantees an optimal balance between mechanical force and physical user input.

### Main features

- The professional's choice
- Attractively priced
- Maintenance free
- Fender protection

### Specifications

<b>Height</b>	1800 mm
<b>Width</b>	685 mm
Max load	Max 60 kg
Net weight	42 kg



## Y471105 Wheel Dolly



This industrial quality wheel dolly increases productivity in the shop by offering a fast & efficient way to remove tire/wheel assemblies. Its ergonomic design helps to reduce back strain injuries.

The extended rollers (ideal with wide base tires) can be installed in 3 positions depending on the wheel size. The roller bearings are of Japanese origin. The rubber wheels have an all new and unique steel core providing optimal life time performance.

### Main features

- Quick detach handle
- Extended rollers - 290mm

### Specifications

Frame width	700 mm
Handle length	1000 mm
 Max weight	220 kg
 Weight	15 kg

Helps prevent back injuries



## Y471123 Smart Disc



Keep those wheel sets mobile in your showroom and workshop! Stack, roll and grab them with (or without) your Smart Cart.

### Specifications

$\varnothing$	68 cm
 Max weight	160 kg

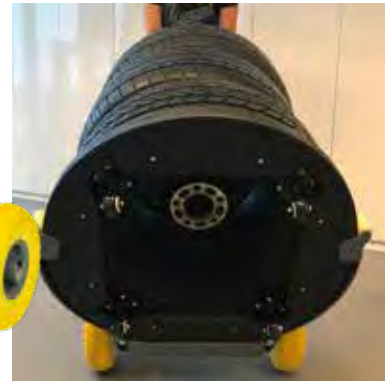

Works perfectly together with Smart Cart



Safety guaranteed



## Y471106 SAFERGO Truck Wheel Dolly

This lightweight, portable dolly has a compact hydraulic unit that ensures precise positioning. It also allows the operator to work on a very short distance from the vehicle which is crucial during road assistance service work.

Its shock absorbing casters ensure a smooth ride from and to the hub on a rough surface. WinnTec delivers you once again affordable ergonomics without affecting operation speed.



### Specifications

Frame width	900 mm
Frame depth	450 mm
Frame height	310 mm
 Max weight	160 kg
 Weight	29 kg



### Main features

- Carry handle & belt
- Maximum mobility
- Fast positioning







# Lifting Equipment

## M411355 Winntec Motion Jack

A new range of fast movers with appealing designs and technical features that convince at a no brainer price point without us squeezing your margin as reseller. It is that simple!

**Designed for the pro - available to all!**

### Main features

- Ultra light jack
- Turbo Lifter System
- 2 speed lowering



Specifications	
A =	90 mm
B =	360 mm
C =	247 mm
D =	481 mm
E =	135 mm
1,5 T	
14,2 kg	

## Y411350 Alloy Jack

Winntec's popular alloy floor jack has been dominating the European market for the last 10 years. The ball bearing-mounted rear swivel caster wheels and wide track front wheels provide easy maneuverability and jack stability under load. A newly designed saddle pad (as subscribed by several European car makers) protects the vehicles bodywork and components.

Thick frame side plates and a reinforced lift arm result in added strength. A bypass and over-load valve prevent from over-extension of hydraulic ram and jack use beyond rated capacity. The 2-pc. handle with quick lock offers easy storage. Heavy duty nylon wheels keep the jack's general weight below 10kg.



### Main features

- Just 10 kg
- Nylon wheels
- PU pad



Specifications	
A =	80 mm
B =	375 mm
C =	236 mm
D =	501 mm
E =	140 mm
1,35 T	
10 kg	

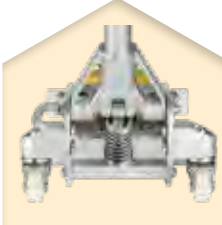

## Y420222 Low Profile Jack

Low profile jack with **integrated jack stand function** and hold to run control. 75mm entrance height, Turbo Lifter, **ERG-O-grip**, handle bumper.

### Main features

- **ULTIMATE SAFETY**
- Auto lock
- Low profile
- Controlled descent
- Foot pedal
- Turbo Lifter System
- Hard chromed ram and pistons



### Specifications

<b>A</b> =	75 mm
<b>B</b> =	500 mm
<b>C</b> =	350 mm
<b>D</b> =	705 mm
<b>E</b> =	135 mm
2 T	2 T
KG	37,5 kg



**NEW!**

Dual purpose lift/support

Ensures positioning deep under vehicle

## Y422000 Long Chassis Low Profile Jack

Low profile jack with a minimum height of 75mm. Long chassis 940mm, fast reach foot pedal, Turbo Lifter, rubber pad, nylon wheels, hold to run control, **ERG-O-grip**, handle bumper.

### Main features

- Low profile
- Long chassis
- Controlled descent
- Foot pedal
- Turbo Lifter System
- Hard chromed ram and pistons



### Specifications

<b>A</b> =	75 mm
<b>B</b> =	530 mm
<b>C</b> =	373 mm
<b>D</b> =	940 mm
<b>E</b> =	135 mm
2 T	2 T
KG	45 kg

**NEW!**

### Jack dimensions

- A** = Min. Height (mm)
- B** = Max. Height (mm)
- C** = Width (mm)
- D** = Length (mm)
- E** = Height (mm)

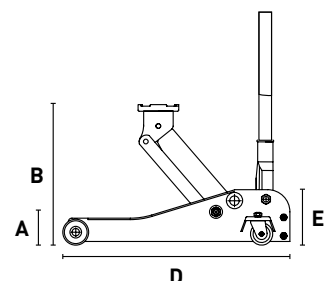
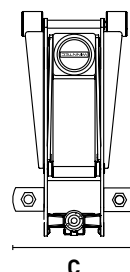

# Lifting equipment

## Y420215

Light weight low profile jack with a minimum height of 85mm, fast reach foot pedal, rubber pad, PU tandem wheels, hold to run control and ergonomic handle.



Polyurethane tandem rollers reduce noise and floor damage. The tandem system guarantees a comfortable ride on a bumpy surface.

### Main features

- Low profile
- PU tandem wheels
- PU pad
- Handle bumper
- Foot pedal



*Smooth ride  
like  
limousine*

Specifications	
A =	85 mm
B =	490 mm
C =	370 mm
D =	795 mm
E =	180 mm
	2 T
	37,2 kg





## Y420250

Ultra low profile design combined with TURBO LIFTER technology. The PU wheels minimize noise and potential (showroom) floor damage. The jack starts at 75mm and reaches an impressive 510mm at maximum height.

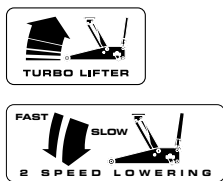
A rubber grip and saddle are standard features. This low profile jack comes with heat-treated chromed pump pistons and chromed main ram.



Specifications	
A =	75 mm
B =	510 mm
C =	343 mm
D =	686 mm
E =	140 mm
	2 T
	32,5 kg



*Our  
Best  
Just got  
better!*



### Main features

- 2 SPEED LOWERING
- Turbo Lifter System
- Ultra low - 75 mm
- PU wheels
- PU pad

### Jack dimensions

- A = Min. Height (mm)
- B = Max. Height (mm)
- C = Width (mm)
- D = Length (mm)
- E = Height (mm)

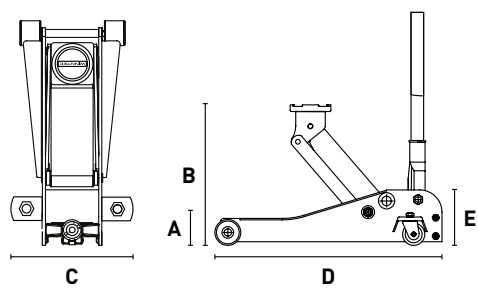



## Y420303

This jack is equipped with Winntecs unique TURBO LIFTER system, rubber pad and handle bumper. The professional universal joint release valve makes it possible to lower the jack with load very precisely and free of any risks.

The heat-treated chromed pump pistons (protected with jacket to prevent from dirt intrusion) are placed at a 45° angle so a complete pumping stroke will always be utilized. Also the main ram has a chrome plating which ensures maximum durability.

### Main features

- Turbo Lifter System
- Steel wheels
- PU pad
- Extremely stable



**CONTAINER SHIPMENT ONLY**



### Specifications

A =	130 mm
B =	490 mm
C =	380 mm
D =	730 mm
E =	160 mm
	3 T
	41 kg

## Y420330

Ideally configured for car dealers and universal workshops. The jack comes with noise reducing PU wheels, a rubber pad/grip and our TURBO LIFTER pump system. With a minimum height of 120mm and its compact size, this 3T jack is the right choice for car dealerships that look for attractive pricing, functionality and safety.

The release valve allows you to lower heavy loads in a controlled way. The main ram and both pistons are chrome plated. Winntec selected the best industrial grade seals and gaskets for its next best seller.

### Main features

- **2 SPEED LOWERING**
- Turbo Lifter System
- PU wheels
- PU pad



*Excellent price-quality ratio*



## Y420333



Our newest jack offers the best possible specifications. It unites the ultra low profile design, a high reach, our newest **2 SPEED LOWERING** technology, the TURBO LIFTER pump system, 3T capacity and noise reducing PU wheels. The highest quality of components will ensure maximum performance and life time.

### Main features

- **2 SPEED LOWERING**
- Low profile
- Turbo Lifter System
- PU wheels
- PU pad
- Foot pedal



### Specifications

A =	76 mm
B =	503 mm
C =	346 mm
D =	672 mm
E =	156 mm
	3 T
	37 kg



WATCH DEMO



# Lifting equipment

## Main features

- Foot pedal
- Ergonomic handle

### Long Chassis Jacks

This range is designed especially for extreme heavy-duty lifting. It is perfect for servicing truck fleets, busses, farm- and heavy construction equipment and other vehicles that require a low starting point and a relatively high reach.

All models feature a foot-operated pump for quicker lifting efficiency, automatic overload safety valve and swivel casters for easy maneuvering around tight spaces. The ergonomic handle features an integrated load control knob which is in connection with a universal joint release valve.



Y420200



Y420301

The big guys





Y420500



Y421000

### Jack dimensions

A = Min. Height (mm) B = Max. Height (mm) C = Width (mm) D = Length (mm) E = Height (mm)

Model	A	B	C	D	E		
Y420200	138	800	396	1310,5	1285	2 T	58
Y420301	130	600	325	1400	1330	3 T	65
Y420500	150	680	366	1505	1345	5 T	90
Y421000	160	680	485	1635	1355	10 T	145

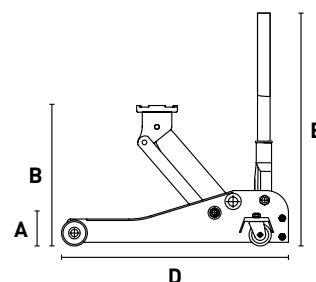
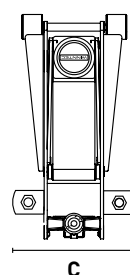



## Y432024 Air Service Jack - Single Stage 24T

This single stage air service jack delivers a massive 24 Ton of power and is guaranteed with a unique 3 year warranty on its interior hydraulic and pneumatic components. It is designed to meet and exceed expectations of a quality jack at a very competitive market value.

The controller allows for the jack to ascend and descend with air. No more relatively unsafe, manual descending of heavy trucks! This Y432024 comes with 3 extensions (20mm-50mm-100mm) and is equipped with a 85mm extension screw. The heavy duty wheels have been designed for daily use. Hard chromed piston.



### Main features

- Pneumatic descend
- Dead-man control
- Extension screw

*Air controlled descent*



## Y432032 Air Service Jack - Telescopic 32T

Dual stage air service jack with a low entrance height of just 150mm and hard chromed piston. With 32/16 Ton capacity and its compact dimensions, this jack is ideal for both workshop and road assistance duty.

The controller allows the jack to ascend and descend with air. This premium Y432032 is backed with 3 years warranty. Air controlled descent ensures maximum safety while dealing with heavy loads.



This Y432032 comes with 2 extensions (45mm-100mm). As an option we offer a 260mm extension which is a great help when lifting trailers.

### Main features

- Chromed pistons
- 150mm entry height
- Compact body

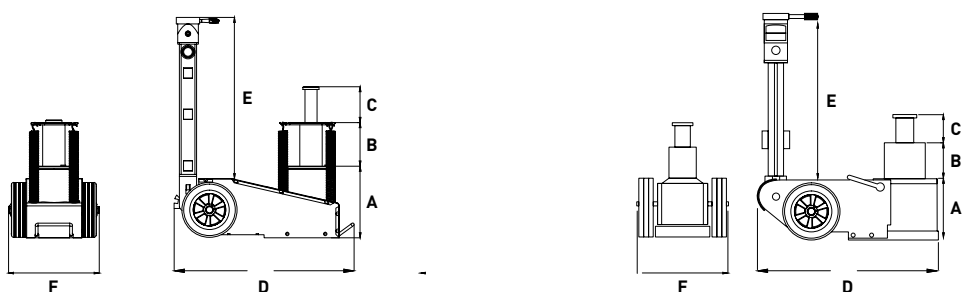
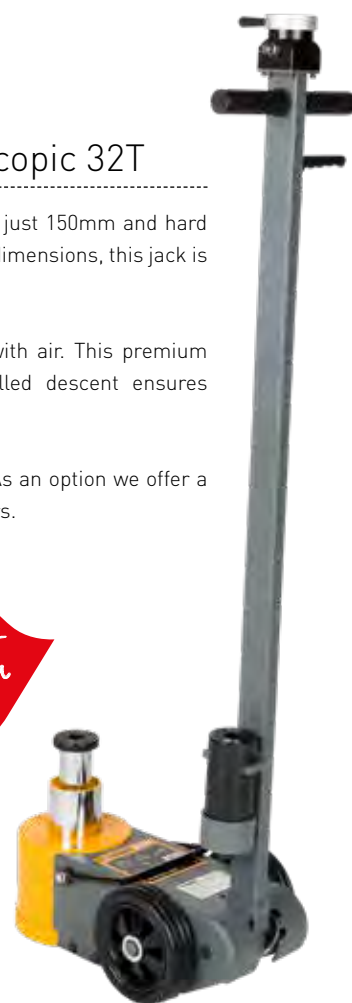
*Low clearance - Maximum mobility*



Model	A	B	C	D	E	F		
Y432024	215	141	85	525	1240	265	24 T	40
Y432032	150	73	66	480	1300	290	32/16 T	38



# Lifting equipment

## Bottle Jacks

Versatile for use in a large variety of applications: pushing, bending, pressing or straightening. The full range comes with cast iron bases, polished main rams and a solid, chromed pump linkage. These jacks are tested to the latest European standards, have overload protection and can be used in both horizontal and vertical positions. All models [except Y413000 & Y411000] have a twist top for precise height adjustments. The **telescopic** Y411000 comes with two extensions (45mm+6mm). Winntec® guarantees a 3 years warranty due to internally machined oil passages, smooth bearing surfaces and close tolerances.



**Y411000**  
Telescopic model 10T



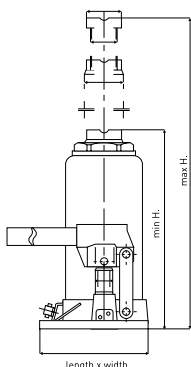

### Main features

- Chromed pistons
- Easy maintenance
- Heat-treated saddle



### Jack dimensions

Model	Base plate (mm)	Min H. (mm)	Lifting H. (mm)	Adjust H. (mm)	Max H. (mm)	 T	 KG
<b>Y410200</b>	96x93	158	90	60	308	2 T	2,3
<b>Y410400</b>	112x104	180	110	60	350	4 T	3,3
<b>Y410600</b>	116x116	197	125	60	382	6 T	4,4
<b>Y410800</b>	120x120	205	125	60	390	8 T	5,4
<b>Y411000</b>	180x118	120	100	-	260	10 T	6,4
<b>Y411200</b>	140x135	214	125	60	399	12 T	7,2
<b>Y411500</b>	140x140	225	140	60	425	16 T	8,3
<b>Y412000</b>	155x140	244	145	60	449	20 T	10,5
<b>Y412001</b>	155x140	190	90	60	340	20 T	9
<b>Y413000</b>	175x160	285	180	-	465	30 T	14,6



## Air Bottle Jacks

Premium quality 20T air & air/manual bottle jacks. These models feature a aluminum air motor, specially heat treated cylinder walls and chrome pistons ensuring premium performance, durability, life and safety. Filters prevent contaminants from entering the air/hydraulic system. **Y432003** can be stored vertically. **Y432021** offers no manually operated pump.



Low profile



### Main features

- Welded base
- Extension screw
- High speed air motor
- Chromed ram



Best in class

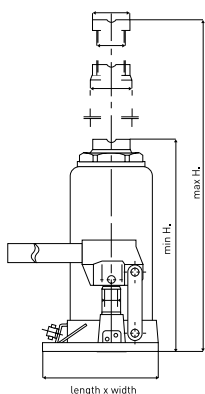

### Jack dimensions

Model	Base plate (mm)	Min H. (mm)	Lifting H. (mm)	Adjust H. (mm)	Max H. (mm)	Capacity (kg)	Capacity (T)
<b>Y432021</b>	180x115	148	66.6	45	260	20 T	9
<b>Y432020</b>	220x175	245	150	80	475	20 T	16.5
<b>Y432003</b>	300x150	253	150	80	483	20 T	25.7



# Lifting equipment

## Pneumatic Balloon Jacks

These pneumatic jacks have an internal telescopic stabilizer (ASTM-513 steel) providing lateral and vertical stability. A safety valve prevents from over inflation.

Light weight Winntec® balloon jacks are the preferred choice of tire shops and body shops because they can be easily placed on lifts. Moreover, these jacks lift extremely fast ensuring quick wheel changes.



### Y422002 Main features

- Just 10 kg
- Ideal on 4 post lift
- PU pad
- Low profile
- 2 Stage



Low profile

Specifications	
<b>A</b> =	100 mm
<b>B</b> =	295 mm
<b>D</b> =	450 mm
2 T	
14 kg	

### Y422012 Main features

- PU pad
- Low profile
- Store upright
- 2 Stage



Long life - High speed

Specifications	
<b>A</b> =	115 mm
<b>B</b> =	295 mm
<b>D</b> =	1100 mm
<b>E</b> =	280 mm
2 T	
15 kg	

### Y422013 Main features

- PU pad
- Store upright
- 3 Stage



Specifications	
<b>A</b> =	145 mm
<b>B</b> =	420 mm
<b>D</b> =	1150 mm
<b>E</b> =	280 mm
3 T	
27 kg	

## Jack dimensions

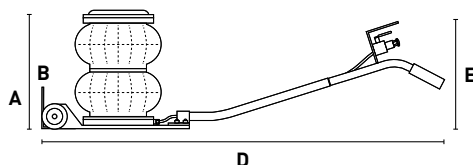
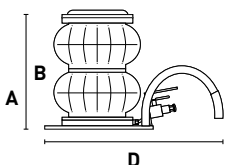



## Toe Jacks

Toe jacks allow you to lift heavy machinery and equipment with a minimum of ground clearance. Since there are lifting points on both the toe and the top of the jack, they are the perfect complement to our range of HD bottle jacks.

All models are equipped with chromed rams/pistons and overload valves.

### Main features

- Housing revolves 360°
- Operate vertically, horizontally and upside down

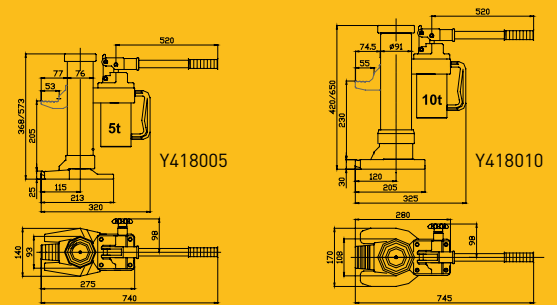

Model	Height (mm)	Width (mm)	Depth (mm)		
Y418005	368/573	320	140	5 T	26
Y418010	420/650	325	170	10 T	36



Massive power from top to toe!

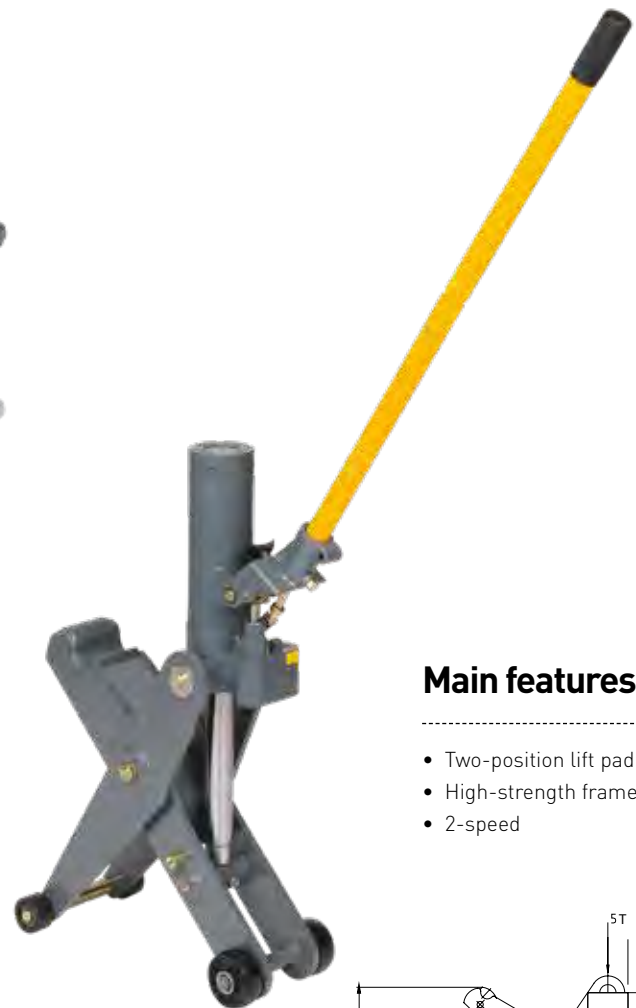

## Y454000 Fork Lift Tractor Jack

Wintec® forklift jack with dual lifting points (4/5T), double speed function without load, chromed ram and chromed pump piston. Lower, extended arm is only 65mm for easy access under forklift trucks. The upright piston at 416mm is ideal for lifting tractors and farm machinery. Hydraulic lift 355mm on forklift arm and 350mm on upright piston. Special designed hydraulic pump with Japanese seal kits and overload valve. Removable handle and compact size.

### Main features

- Two-position lift pad
- High-strength frame work
- 2-speed

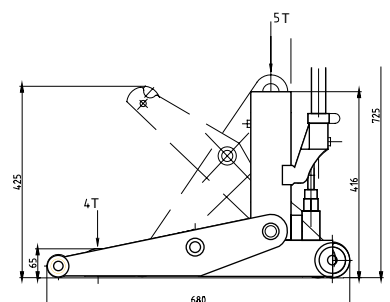

Model	Max H. (mm)	Min H. (mm)	Length (mm)	Height (mm)		
Y454000	425	65	680	725	4-5 T	45

# Lifting equipment

## Y475053 Scissor lift 3.2T

**Mid rise** scissor lift with automatic runway levelling system with master/slave hydraulic circuit. Self lubricating bushings and anti-rotating system. Mobility kit included! Low 120mm – High 1000mm.

## Y475054 Scissor lift 3.2T

**High rise** scissor lift (above ground) with automatic runway levelling system with master/slave hydraulic circuit. Self-lubricating bushings and anti-rotating system.

Both lifts have flaps that fold 66° so contact with the wheel will be avoided during lifting process. Italian patented design, safety (global product liability), comfort and robustness by Corwei (Nexion Group).

- Capacity 3200 kg

Specifications	
<b>Width =</b>	1910 mm
<b>Length =</b>	2040 mm
<b>Min. H. =</b>	110 mm
<b>Max H. =</b>	630 mm
	3.2 T

Specifications	
<b>Width =</b>	2054 mm
<b>Length =</b>	2124 mm
<b>Min. H. =</b>	105 mm
<b>Max H. =</b>	2040 mm
	3.2 T

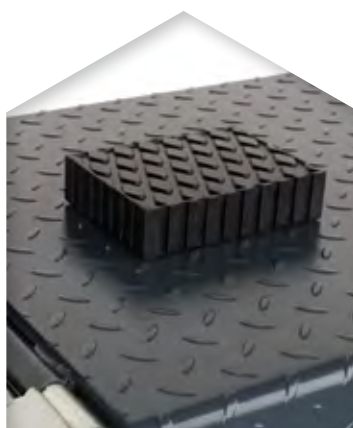



## Y475052 RAZZO1 1.8T

### Mini lift with mechanical safety lock

Work on your vehicle at the right height for: Bodyshops, Garages, Tire-shops, Detailing & Wraps. Extremely versatile lift, operated with a industrial, airhydraulic footpump, which allows you to quickly lift and support any small/large car, vans and SUVs.



**NEW!**

#### TECHNICAL DATA

Length (arms withdrawn)	1120 mm
Length (arms extended)	1620 mm
Operation	Hydro-pneumatic
Hydro-pneumatic pump calibration	700 Bar
Inlet air pressure	7-10 bar

#### Specifications

Width =	400 mm
Length =	1620 mm
Min. H. =	110 mm
Max H. =	630 mm
1.8 T	
113 kg	



WATCH DEMO

## Y475051 IN-SYNCH2 2.5T

Our IN-SYNCH2 sets itself apart from other low-rise lifts because it offers open undercarriage access. It is portable and easy to maneuver. The remote control, connected with a industrial hydraulic pump, ensures smooth lifting and lowering.

As far as safety concerned our patented valve block guarantees perfectly in-sync lifting and lowering when dealing with heavy loads. Quick-connect fittings conveniently connect the pump and lifts (with long hoses), making it easy to assemble/disassemble and stow individual components.

#### TECHNICAL DATA

Frame width	300 mm
Frame Length (lowest position)	1910 mm
Lifting point spread (Min.)	800 mm
Lifting point spread (Max.)	1320 mm
Operation	Hydro-pneumatic
Hydro-pneumatic pump calibration	350 Bar-5076 PSI
Inlet air pressure	7-10 bar



WATCH DEMO

**NEW!**

#### Specifications

Length =	1800 mm
Min. H. =	85 mm
Max H. =	455 mm
2.5 T	
95 kg	



# Workshop equipment

## Y440102 Foldable Crane

Constructed from heavy gauge, welded square tubular steel. The 2-speed hydraulic pump with chromed ram rotates up to 135 degrees ensuring the optimal working position. Fine adjustment lowering handle with dead man's control prevents from rapid uncontrolled lowering of load. Nylon wheels avoid floor damage. The arm has 3 pre-set positions (1000/750/500 kg) for lifting. Easy to maneuver in open or closed position due to unique supporting wheels at the front of the base plate. Crane is packed in wooden box.

### Main features

- Hook with bearing
- Dead-man control
- Swivel pump



Y440102

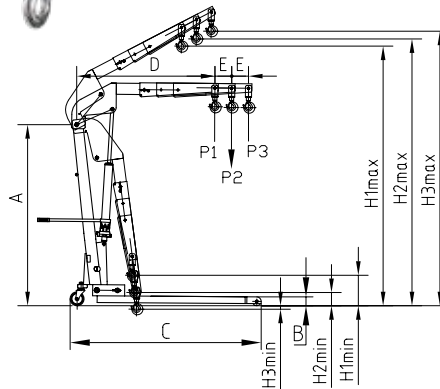

Capacity (kg)	P1	1000
	P2	750
	P3	500
Specs (mm)	A	1405
	B	90
	C	1499
	D	1009
	E	125
	H1min	334
	H2min	214
	H3min	94
	H1max	2120
	H2max	2210
	H3max	2300



## Y440105 Leveler

Engine leveler with a maximum capacity of 550 kg constructed from durable drop-forged steel for long-lasting dependability and performance. It features heat-treated chains that are fully adjustable with a threaded rod. Comes with two 100cm load chains.





Y440105

## Y440300 Engine Support

Constructed of heavy-duty powder coated steel for durability, the 300 kg capacity engine support bar enables you to work on heavy automotive repairs, such as removing your transmission or transaxle.



Specifications	
Height =	-
Width =	243 mm
Length =	1500 mm
 Capacity	300 kg
 Weight	12,5 kg

## Y450101 Engine Stand

A time saver for passenger car and light truck engine rebuilding or repair. Four adjustable attachment arms make engine mounting fast and easy. Engine can be rotated a full 360° with a turn of the handle, a locking pin secures the work in any of the 8 positions.

The leg design prevents the stand from tipping over while holding the engine block. The front swivel caster allows proper positioning.

### Main features

- "L" shape base for stability
- Fully adjustable 360° support

Shop must-have



Specifications	
<b>Height</b> =	900 mm
<b>Width</b> =	780 mm
<b>Length</b> =	820 mm
<b>Weight</b>	400 kg
<b>Weight</b>	24 kg

## Y451550 High Lift Transmission Jack

Their wide base provides superior stability under load. A highly efficient pump system ensures a fast and precise approach. For use in pits and underneath elevated vehicles. Suitable for installing and dismantling gearboxes, motors & couplings.

### Main features

- Dead-man control
- Wide base with swivel wheels
- Fast approaching speed
- Block foam to protect vehicle parts
- Turnable saddle

High stability



Model	Min H. (mm)	Lifting H. (mm)	Max H. (mm)	Height (mm)	Width (mm)	<b>Weight</b>	<b>Weight</b>
Y451550	1150	865	2015	770	675	550 kg	56

## Y451550-ADAP Transmission adaptor

Fully adjustable gearbox support with forward, backward and side-to-side tilt.



Specifications	
<b>Height</b> =	29 mm
<b>Width</b> =	30 mm
<b>Length</b> =	30 mm
<b>Weight</b>	550 kg
<b>Weight</b>	13 kg



# Workshop equipment

Never compromise safety

## Jack Stands

All stands are packed in pairs and intended to be used as such.

### Y450301

#### Main features

- Ratchet type
- Base with foot pads
- Positive lock/handle carrying



### Y452300

#### Main features

- Pin type
- Large PU support pad



### Y451600

#### Main features

- Ratchet type
- Base with foot pads
- Positive lock/handle carrying



## Y451205 Low Profile Jack Stand Set

Low profile jack stand with handle and wheels for easy positioning under the vehicle. The pin type support column adjusts to five different height positions. A 22cm square base secures and stabilizes load.

#### Main features

- Pin type
- Nylon wheels
- Handle low profile



### Y452600

#### Main features

- Pin type
- Large PU support pad



**NEW!**



Sold by single piece



## Y451206 High Reach Jack Stand

Heavy duty, high reach welded jack stand with detachable handle, multi-angle handle socket and wheels for easy positioning under the vehicle.

The pin type support column adjusts to various height positions up to 971mm making it suitable for both tire service and general trailer service jobs where chassis support is needed.

#### Main features

- Nylon wheels
- Pin type

Model	Min H. (mm)	Max H. (mm)	W	L	Ø (mm)		
Y450301	305	450	185	209	-	3 T	7
Y452300	322	465	-	-	254	3 T	5,2
Y451600	395	625	263	293	-	6 T	13,8
Y452600	404	604	-	-	341	6 T	11,2
Y451205	302	450	280	220	-	12 T	20
Y451206	601	971	423	370	341	12 T	29,2



## Y491110 Mechanic Gloves

The Winntec® Mechanic Glove is a sturdy glove with protectors for professional work in the workshop, assembly, handling of machines and materials. **Sizes: M - L - XL**



## Main features

- Impact protection
- Slip free silicone grip
- Double stitched
- Industrial hook and loop
- Machine washable



## Y491310 Precision Gloves

Winntec® Precision Glove is perfect for a variety of automotive service jobs that demand a 'fine touch'.

We've selected the most sensitive Polyurethane synthetic leather for the palm with a touchscreen functional PU material on the index finger. The back is made by comfortable nylon/spandex rib and polyester air mesh. The cuff closes with velcro and is partially reflective. **Sizes: L - XL**



## Main features

- Fine Touch
- Anti Slip
- Breathable stretch
- Abrasion resistant
- Terrycloth thumb
- Touch screen proof







# Workshop equipment

## M499330 Workshop Stool

Workshop stool with large diameter comfort seat and 5 HD wheels. The ideal, gas spring operated, helper for minor repairs, cleaning, adjustment and maintenance work.



Specifications	
∅ Seat =	315 mm
Min. H. =	380 mm
Max. H. =	510 mm
Weight =	135 kg
Weight =	5,5 kg



## M499440 Foldable Creeper/Seat

Extra long, foldable workshop creeper/seat with 7 HD wheels for easy maneuverability. Thick padded cushions create a comfortable base for easy access and movement during your maintenance tasks. Thick vinyl padded seat and headrest.

Specifications	
Length =	1200 mm
Width =	410 mm
Height =	140 mm
Weight =	115 kg
Weight =	12 kg



Great promo product!

## Y490022 Waterproof backpack XL

This robust waterproof backpack is ideal for all conditions. Whether you live in a rainy environment or are snowed under all year round, this one waterproof backpack protects your personal belongings, whatever the weather.

The Winntec® Y490022 is made of 100% waterproof materials and all seams are welded so that no water can leak through. The roll-top closure provides extra protection against the elements while you still have quick access to your belongings.

The spacious main compartment offers ample storage space, while being splash-proof externally zipper pocket contains your essential supplies such as wallet, telephone and keys.

### Main features

- 100% PVC
- Waterproof
- Floats
- Extra spacious







[winntec.net](http://winntec.net)

# Workshop equipment

## Industrial Presses

Our range of presses with welded framed are suitable for standard daily pressing, bending, bonding and straightening jobs in the shops.

Essential for the removal/installation of universal joints, bearings, pulleys, and wrist pins. Including 2 V-blocks for easy and secure positioning.



**NEW!**



Y461515

### Main features

- Bench model
- Single speed hand pump
- Gauge and hydraulics components built into the frame



Y461520

### Main features

- 2-speed hand pump
- Optional: punch set and protection cover



Y461530

### Main features

- 2-speed hand pump (fast approach)
- Gauge and hydraulics components built into the frame





Y461533

**NEW!**

### Main features

- 2-speed hand pump
- Movable cylinder (left-right)
- Pneumatic foot operation
- Optional: punch set and protection cover

Model	Height (mm)	Depth (mm)	Width (mm)	 T	 KG
Y461515	800	350	550	15 T	48
Y461520	1830	540	850	20 T	101
Y461530	1850	488	670	30 T	112
Y461533	1850	540	840	30 T	137

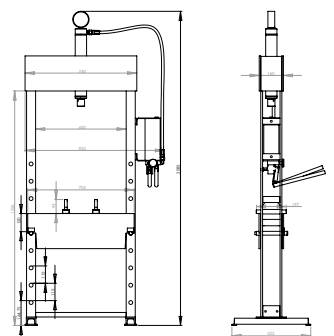



Y461550

### Main features

- Single speed hand pump
- Pneumatic foot operation
- Movable cylinder (left-right)
- Winch operated work bed
- Gauge and hydraulics components built into the frame
- Incl. removable punch set tray
- Optional: protection cover



Y461533-PC  
Protection cover





Y461533-PS  
Punch set



Y461650

### Main features

- Pneumatic and manual foot operation
- Movable cylinder (left-right)
- Floating work bed
- Gauge and hydraulics components built into the frame
- Incl. removable punch set tray
- Optional: protection cover

Model	Height (mm)	Depth (mm)	Width (mm)	 T	 KG
Y461550	1900	490	890	50 T	191
Y461650	1920	490	890	50 T	225



# Workshop equipment

## Y444000/Y444100 Collision Repair Sets

Both 4T (Y444000) and 10T (Y441000) include solid blow cases, chromed rams/pistons and safety valves to prevent from overloading. Their heavy gauge snap-together pipework and cast attachments are compatible with most leading brands of body repair equipment.



### Supplied with the following parts:

Single Speed Hand Pump • Cylinder (100 mm stroke Y444000 - 150 mm stroke Y444100) • Hose • Ram Flat Base • Spreader • 100 mm Extension Tube • 150 mm Extension Tube • 300 mm Extension Tube • 400 mm Extension Tube • Tube Coupling • Ram Toe • Wedge Head • Serrated Saddle • Flex Head • Plunger Toe • 90 Degrees Wedge Head • Storage Case.



## Main features

- Quick lock for fast assembly and disassembly
- Spring guards at hose end
- Thick walled extension tubes

Model	Cylinder (mm)		
Y444000	100	4 T	17
Y444100	150	10 T	31



*Avoids injuries - saves time*



## Y471180 Wheel Removal kit

This kit eliminates one of the most dangerous jobs within the tire service industry: WHEEL REMOVAL! Alloy and light steel wheels are often frozen (glued) to the vehicle.

This ready-to-use kit includes a case, cylinder, pump, hose and a variation of adaptors to be installed depending on the space between the wheel and the chassis of the vehicle. With 10 Ton of hydraulic power and manual control of the foot pump, it becomes a safe and quick job to press the oxidized wheel from the vehicle.

## Main features

- All-in-one solution
- Foot operated
- Metal case

Specifications	
Height =	150 mm*
Width =	480 mm*
Depth =	235 mm*
	10 T
	15 kg

\* Case Dimensions



## Y471150 Air Hydraulic Pump 1600 cc

For use with a variety of rams, presses and hydraulic tools operating up to 700bar/10.000 psi. Air exhaust muffler for quiet operation. Aluminum housing.

Two stage release mechanism; pump, hold or release with pedal control. Air inlet 1/4, outlet 3/8. Working pressure 6-10 bar. Weight: 7,9 kg.



## Y4781155 Single Acting 2-Speed 900 cc 70 Mpa

Light weight, high flow industrial pump with baked enamel finish to increase corrosion resistance. The compact design ensures efficient storage and transportation. Less handle effort to minimize operator's fatigue. Internal pressure relief valve prevents from overload situation. Industrial 3/8-18NPT outlet. Weight: 6,8 kg.



## Y4781106 Single Acting Cylinder 89-115mm 10T Y4781107 Single Acting Cylinder 42-52mm 10T

High strength alloy steel for maximum safety and durability. Collar thread on high model enables easy fixture. Unique heavy duty spring provides fast piston return. Industrial 3/8-18NPT connections. Weight: 1,5 kg.



## Workshop equipment

### Y471120 Hydraulic Combi Bead Breaker

Designed to work on all single, two and three pieces 2-5-10 hole budd, 7.50x16s and all tubeless tire/rims.

Includes 3 claws. Working range up to 120mm. Self retracting. Durable anti-corrosive finish.

### Y471130 Earthmover Bead Breaker

Designed for use on 5 piece 25" to 51" with pry bar/bead loosening pockets. Working range 110mm. Capacity: 10T.



Conquer any bead!

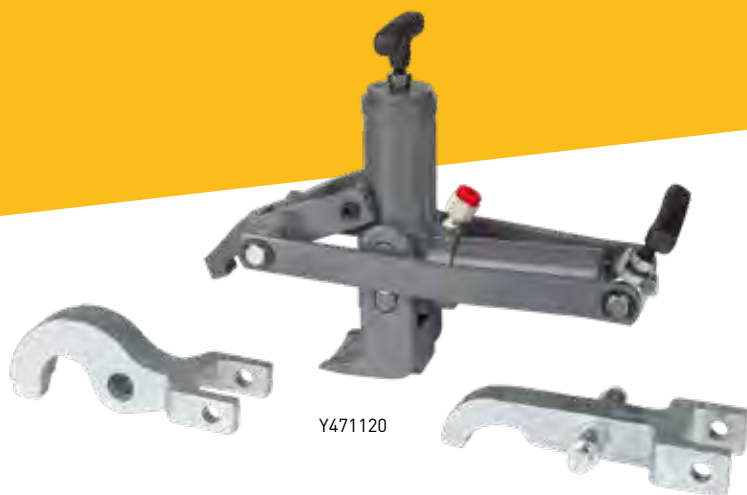

Y471120



Y471130



Y478205

### Y478205 Hose Assembly 2,50 mt

Compatible with Y471150 and Winntec Bead Breaker models Y471120 and Y471130.



### Y472269 Wheel centering bolts

These wheel centering bolts simplify the heavy wheel / wheel spacer install process by holding the rim centered on the hub as you hand screw in your lug nuts. Just screw the wheel pin in to the top bolt hole and slide your rim over the pin on to the hub. You'll get perfect rim to hub alignment every time making the job faster, easier and safer.

Particularly useful when replacing the brake discs - the centering bolt ensures that the holes in the new disc are perfectly aligned with the holes in the wheel hub. The four most common thread and pitch sizes are included in this set (M12x1.25, M12x1.50, M14x1.25, M14x1.50).





# Accessoires

## Extensions

### Y411350-48

Rubber extension 95mm for Y411350.



### Y420210-ADAP

Extension 100mm for Y420210/Y420215.



## Rubber Saddle Pads

### Y420210-30

Rubber saddle for Y420210/Y420215.



### Y420303-38

Rubber saddle for Y420303.



### Y420250-34

Rubber saddle for Y420250.



### Y420330-40

Rubber saddle for Y420330.



### Y411350-42

Rubber saddle for Y411350.



### Y412500-46

Rubber saddle for Y412500.



## GT260MM

Extension 260mm for Y432032.



## Wheels

### Y420303-PUWS1

PU wheel set for Y420303.





## Workshop equipment

### Y351100 - 12V-1300A Booster

Heavy Duty 12V Ultracapacitor jump starter with back-up lithium battery.

- Starting current: 1300 CA / 2600 PA
- Can start 5.0L diesel engines
- Features a rotomolded and unbreakable case, heavy-duty curved clamps and double-insulated 1.30m-25mm<sup>2</sup> cable
- Three ways of precharging the internal capacitors:
  1. From vehicle's flat battery (60-120 sec)
  2. On-board a vehicle via the 12V cigarette-lighter cable (4-6 min)
  3. With the internal lithium battery (4-6 min)
- Digital display shows vehicle's battery voltage and charging level of internal capacitors
- Comes with a 12V cigarette-lighter cable and a Micro-USB cable to charge the lithium battery



### Y243000 - 12/24V Booster

Heavy Duty 12/24V Ultracapacitor Jump Starter with back-up lithium battery.

- Cranking Current: 1500A (12V) / 750A (24V)
- Peak Current: 3000 (12V) / 1500A (24V)
- Can start all types of vehicles up to 600HP, including trucks and busses
- Ultracapacitors are maintenance-free, have an almost infinite lifespan and can be used in extreme temperature conditions (-40°C to +60°C) with no effect on their performance.
- The internal capacitors easily precharge from the vehicle's battery residual energy in 2-4 minutes. If the vehicle's battery is empty or absent, the internal lithium battery will kick in and charge the capacitors in 5 minutes.
- Lightweight (10.3kg) – 2 times lighter than traditional 12/24V jump starters
- Features a rotomolded and unbreakable case, heavy-duty curved clamps and double-insulated 1.70m-35mm<sup>2</sup> cable
- LCD display shows vehicle battery voltage, charging level of internal capacitors and lithium battery.
- Equipped with a rotary switch to select voltage
- Lithium LiFePO<sub>4</sub> 3.2Ah battery is perfectly safe and long-lasting. It can be charged with the provided wall charger or onboard 12V and 24V vehicles with the provided charging cable.



 WINNTEC





Winntec® is a brand owned by TMG

Rechtzaad 6, 4703 RC Roosendaal

The Netherlands

+31 165 561 613 | info@winntec.net

winntec.net

We  Jacks  
*Lifting devices sold since 2002*

