

EMH metering

GmbH & Co. KG

Neu-Galliner Weg 1 • 19258 Gallin
GERMANY

Tel. +49 38851 326-0

Fax +49 38851 326-1129

Email info@emh-metering.com

Web www.emh-metering.com

Tel. +49 38851 326-1930 (Technical Support)

Email support@emh-metering.com



NXT4

Polyphase meter for commercial, industrial and extended domestic applications

EN Instructions for use

Scope of delivery	2
Important information.....	2
Target group	2
Intended use.....	2
Maintenance and warranty instructions.....	3
Care and disposal information.....	3
Basic safety instructions.....	4
General description	4
Technical data.....	5
Housing, display and control elements.....	6
Name plate	7
LC display.....	8
Installation and start-up	10
Mounting the meter	10
Connecting the meter	12
Terminal blocks.....	14
Readout battery (accessory)	19
Terminal cover	19
Abbreviations.....	20
EU Declaration of Conformity	22

Scope of delivery

Please check the contents of the packing box are complete before starting with the installation and start-up procedure.

- 1 NXT4 device
- 1 Instructions for use
- Accessory (optional):
 - Readout battery
 - Path separator

If the contents are incomplete or damaged, please contact your supplier. Store, use and transport the device in such a way that it is protected against moisture, dirt and damage.

Important information

These instructions for use are part of the documentation. These instructions list all the different device versions. Some of the features described herein may not be applicable for your particular device.



More comprehensive information about the device is available in the product manual. Please also observe all the documents included with other components.

Target group

These instructions are intended for technicians who are responsible for the installation, connection and servicing of the devices. The device may only be installed and started up by qualified electricians in accordance with the generally accepted technology standards and, where applicable, the definitive regulations governing the erection of communication equipment and terminal devices.

Intended use

The meter is intended to be used solely for the measurement of electrical energy, and it must not be operated outside the specified technical data (see name plate).

Maintenance and warranty instructions

The device requires zero maintenance. It is not permitted to make any repairs in the event of any damage (e.g. due to transport, storage). If the device is opened, the warranty will be rendered null and void.

The same applies where a defect is caused by external factors (e.g. lightning, water, fire, extreme temperatures and weather conditions), or by improper or careless use or handling.

The seals may only be broken by authorized personnel.

Care and disposal information

Use a dry cloth to clean the device housing. Do not use any chemical cleansing agents!

The following table names the components and how they are to be treated at the end of their life cycle.

Components	Waste collection and disposal
Printed circuit boards	Electronic waste: Dispose of such waste in accordance with the local regulations.
LEDs, LC displays	Hazardous waste: Dispose of such waste in accordance with the local regulations.
Metal parts	Recyclable material: Collect this material and sort it into separate metal containers.
Plastic parts	Send sorted plastic parts to a recycling plant (regranulation) or, where applicable, to a waste incineration plant (thermal energy generation).
Batteries	Take safety precautions against short circuits before disposing of the batteries. Dispose of the batteries in their original packaging or insulate the terminals. Do not dispose of batteries with the domestic waste; instead, observe the locally applicable waste and environmental protection standards.

Basic safety instructions

Please adhere to the following basic safety instructions:

- Read all the enclosed instructions and information.
- Observe the warnings on the device and in the documents.
- Always be aware of safety issues and hazards when working on the device.
- The customary local occupational health and safety regulations for electrical installations must be observed during assembly, installation and removal of the device.
- Make sure that the installation and operating location of the device meets the specifications in the technical data.
- Before assembly, check the devices for any transport damage or other externally visible damage.
- Only use the device if it is in a technically flawless state, and solely in line with its intended use.
- The connection cables used to connect a meter must be selected to match the maximum load of the meter and the installation environment in terms of type, cross-section, voltage and temperature.
- Attach ferrules to flexible wires.
- Observe the maintenance and warranty instructions.
- If the mains power fails and then returns, there is no need to do anything to the meter.

General description

The meter is used for measuring electrical variables in industrial and commercial applications. It is available for indirect connection up to a maximum of 20 A and for direct connection up to a maximum of 120 A. The active energy is measured to an accuracy class of 1 S or 0.5 S.

Technical data

Voltage, current, frequency, utilisation category	See name plate
Overvoltage category	OVC III (as per EN 62052-31)
Rated peak withstand voltage	4 kV (as per EN 62052-31)
Input System voltage	58...277 V, 2 each
Output Optocoupler MOSFET Relay	58... 240 V AC/DC, 0.1 A 58... 240 V AC/DC, 2 A NO
Temperature range	Defined operating range: -25°C...+55°C Limit for operation: -40°C...+70°C Limit for storage and transport: -40°C...+70°C
Humidity	Maximum 95%, non-condensing, as per EN 62052-11, EN 50470-1 and EN 60068-2-30
Protection class	II
Degree of protection	Housing: IP 54 Connections: IP 31
Fire properties	As per EN 62052-11
Environmental conditions	Mechanical: M1 as per Measuring Instruments Directive (2014/32/EU) Electromagnetic: E2 as per Measuring Instruments Directive (2014/32/EU) Intended operating site: Interior as per EN 50470-1
Weight	Approx. 1.3 kg (with relay 1.7 kg)

Housing, display and control elements

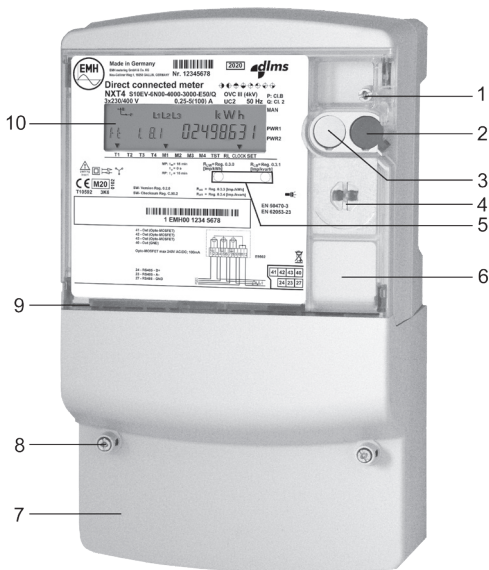

- 1 - Meter cover sealing screw
- 2 - Reset button, sealable
- 3 - Call-up button
- 4 - Optical data interface D0, optical call-up button, left
- 5 - Test LEDs
- 6 - Space for transformer plate (for transformer connected meters only)
- 7 - Terminal cover, sealable
- 8 - Terminal cover sealing screw
- 9 - Meter cover, sealable
- 10 - LC display

Name plate

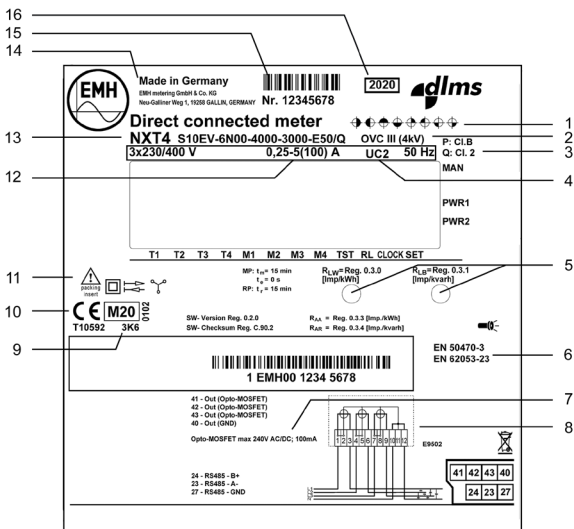

- 1 - Registered quadrants
- 2 - Overvoltage category
- 3 - Accuracy class
- 4 - Utilisation category
- 5 - Recess for test LEDs
- 6 - Product standard
- 7 - Assignment of inputs and outputs, interfaces
- 8 - Information about connection to meter, connection diagram
- 9 - Temperature class as per EN 60721-3-3
- 10 - Conformity and certification marking
- 11 - Safety and application information
- 12 - Voltage, current and frequency
- 13 - Type designation and type code
- 14 - Manufacturer's address
- 15 - Serial number
- 16 - Year of construction

LC display

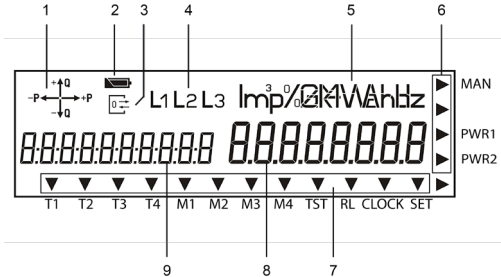

1. The **operation display** shows the energy direction that is currently being measured by the meter (supply/draw of active power, inductive/capacitive reactive power). If a load current is flowing through the meter, the energy direction arrow indicates which quadrant is being used for the measurement, e.g.:

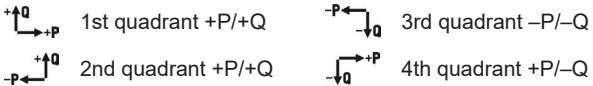

2. The **battery status indicator** shows the residual capacity of the readout battery or the internal power reserve of the real time clock.

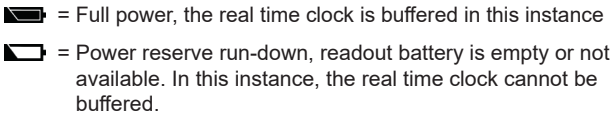

3. The **communication display** lights up permanently when the data interface (optical or electrical) and the meter are communicating. It flashes on and off when the parameterisation status is active.
4. The **phase display** indicates when individual phase voltages are applied. All 3 symbols flash on and off when the rotating field is wrong.
5. The **unit** shown matches the type of energy being measured or the measured value displayed.

6. The **additional cursor field** displays the operating states for the meter. The arrows indicate whether any manipulation or an installation error was registered or if the power threshold was exceeded.
 - MAN** The cursor is active where any manipulation of the terminal cover, meter cover or any magnetic influence is registered.
 - PWR1** The cursor is active if the first defined power threshold in the meter was exceeded.
 - PWR2** The cursor is active if the second defined power threshold in the meter was exceeded.

7. The **standard cursor field** displays the operating states for the meter. The arrows indicate which tariff and maximum meter are active, and how the meter is being controlled (clock or ripple control receiver).
 - T1 - T4** Tariff information for energy. All activatable tariff indexes are denoted on the name plate.
 - M1 - M4** Tariff information for power. All activatable power indexes are denoted on the name plate.
 - TST** The cursor is displayed if test mode is activated.
 - RL** The cursor flashes on and off as long as a resetting lock is active.
 - CLOCK** The cursor is active when the internal device clock actuates the tariff meter.
 - SET** The cursor is active when the meter is in the Set mode.

8. The **value area** displays the measured values.
9. The **code area** defines the measured values according to the OBIS key. The display can show all six value groups.

Installation and start-up

The meter can be wall-mounted as per DIN 43857-2.

The following figures show the relevant dimensions for mounting the meter, depending on the model involved.

Mounting the meter

a) Meter with short terminal cover

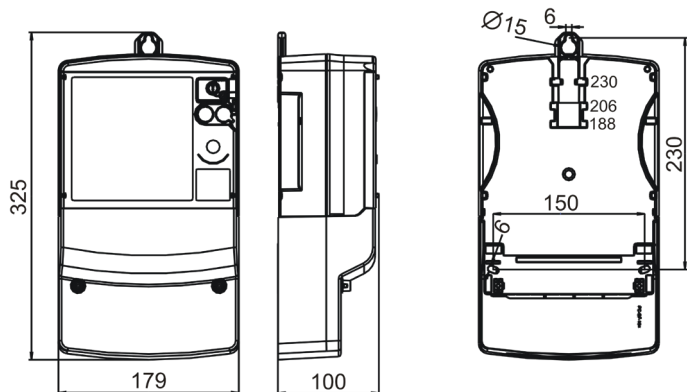

Dimensions in mm

Connecting the meter

DANGER!

Risk of fatal injury in case of contact with live parts!

During installation or when replacing the meter, the wires connected to the meter must be de-energised.

- Remove the corresponding pre-fuses and store them in a secure location to ensure that no-one else can insert the pre-fuses again without being noticed.
- If you use selective automatic circuit breakers for system disconnection, secure them to prevent them from being switched-on again without being noticed.
- Before the installation of a meter, make sure that the consequences of disconnecting the electrical system will not result in immediate danger to the life or health of persons or cause any economic damage.
- To avoid any immediate hazards or damage, take appropriate measures to prevent malfunctions before disconnection of the system.
- Do not use the internal disconnection relay as a load disconnecting switch when disconnecting electrical systems.
- Use the specified screw-type terminals only for installation and connection of the meter.
- Route the connection cables in the vicinity of the meter connection terminals in such a way that they are not kinked or jammed when the terminal cover is fitted into place.

DANGER!

Risk of fatal injury due to arcing and electric shock!

The voltage taps in the meter are not fuse-protected, and are connected directly to the main voltage.

- External devices that are operated using the meter's voltage taps must be fuse-protected with a pre-fuse of ≤ 0.5 A in accordance with the applicable technical regulations.

DANGER!

Risk of fatal injury due to arcing and electric shock!

The inputs and outputs for the additional terminal, including the external power supply inputs, are not fuse-protected in the meter.

- The inputs/external power supply inputs must be fuse-protected with a pre-fuse of ≤ 0.5 A in accordance with the applicable technical regulations.
- The outputs must be fuse-protected as per the current specifications on the meter name plate in accordance with the applicable technical regulations.

ATTENTION!

Application of excessive torque will damage the connection terminals!

The appropriate torque is dependent on the type of connection line involved and its maximum current.

- Tighten the connection terminals to the corresponding torque as per EN 60999-1.



When connecting the meter, always observe the corresponding connection diagram, which is located on the meter's name plate or, where applicable, in the delivery documents.



Using an additional module:

Adapters, spacers, cable connections and suchlike may not be installed between the meter and the (optional) additional module, e.g. the modem.

Terminal blocks

a) Transformer connected meter

DANGER!

Risk of fatal injury in case of contact with live parts!

- The electrician is responsible for coordination of the rating and line-side properties of the overcurrent protection devices with the maximum rated current.
- The transformer connected meter must be fuse-protected in a voltage circuit using a pre-fuse with $< 6\text{ A}$.
- The current paths must be fuse-protected as per the current specifications on the meter's name plate in accordance with the applicable technical regulations.

DANGER!

Risk of fatal injury from high voltage when power converters disconnected!

In transformer connected meters, the high voltage generated on a disconnected power converter can cause fatal injuries, and will destroy the power converter.

- Before disconnecting the current paths, short-circuit the secondary circuits of the power converter at its testing terminals.

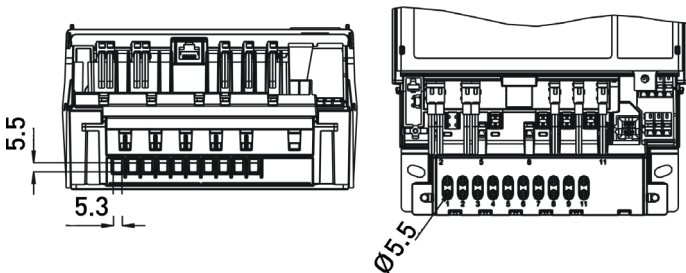

Transformer connected meters	Main connection terminals 1, 2, 3, 4, 5, 6, 7, 8, 9, 11	Additional terminals
Terminal dimensions W x H (mm)	5.3 x 5.5	2.6 x 2.2
Minimum connection cross sections (mm ²)	2.5	1.0
Maximum connection cross sections (mm ²)	10.0	2.5
Maximum torques (Nm)	1.5	---
Screw type	Screw with washer assembly with slot and Pozidriv PZ1 drive	Spring-loaded terminals
Thread size	M4	---

* Rated connection capacity based on EN 60999-1

b) Meter for direct connection at 120 A

DANGER!

Improper installation endangers life and health, and can lead to malfunctions and material damage!

- Use an overcurrent protection device rated for a maximum of 120 A as per the applicable Technical Connection Rules for Power Installations (e.g. selective main line circuit breaker) upstream of a meter with direct connection.
- The connecting paths must be fuse-protected as per the applicable technical regulations and in accordance with the current specification on the meter's name plate.
- The installer bears responsibility for coordinating the rated values and parameters of the supply-side overcurrent protection devices with the maximum rated currents as well as the rated consumption category of the meter system for directly connected meters.
- The connection cables used to connect a meter must be selected to match the maximum load of the meter and the installation environment in terms of type, cross-section, voltage and temperature.

Meter with direct connection up to 120 A	Main connection terminals 1, 3, 4, 6, 7, 9, 10, 12	Additional terminals
Terminal dimensions W x H (mm)	9.8 x 10.0	2.6 x 2.2
Minimum connection cross sections (mm ²)	2.5	1.0
Maximum connection cross sections (mm ²)	35.0	2.5
Maximum torques (Nm)	3.5	---
Screw type	Screw with washer assembly with slot and Pozidriv PZ2 drive	Spring-loaded terminals
Thread size	M6	---

* Rated connection capacity based on EN 60999-1

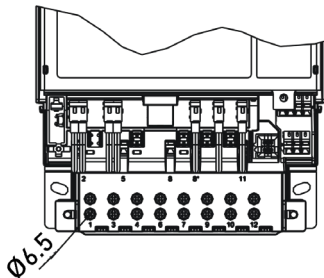
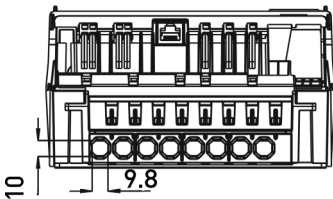

c) Meter for direct connection at 100 A (with 3-phase cut-off device)

⚠ DANGER!

Improper installation endangers life and health, and can lead to malfunctions and material damage!

- Use an overcurrent protection device rated for a maximum of 100 A as per the applicable Technical Connection Rules for Power Installations (e.g. selective main line circuit breaker) upstream of a meter with direct connection.
- The connecting paths must be fuse-protected as per the applicable technical regulations and in accordance with the current specification on the meter's name plate.
- The installer bears responsibility for coordinating the rated values and parameters of the supply-side overcurrent protection devices with the maximum rated currents as well as the rated consumption category of the meter system for directly connected meters.
- The connection cables used to connect a meter must be selected to match the maximum load of the meter and the installation environment in terms of type, cross-section, voltage and temperature.

Meter with direct connection up to 100 A (with 3-phase cut-off device)	Main connection terminals 1, 3, 4, 6, 7, 9, 10, 12	Additional terminals
Terminal dimensions W x H (mm)	9.8 x 10.0	2.6 x 2.2
Minimum connection cross sections (mm ²)	2.5	1.0
Maximum connection cross sections (mm ²)	35.0	2.5
Maximum torques (Nm)	3.5	---
Screw type	Screw with washer assembly with slot and Pozidriv PZ2 drive	Spring-loaded terminals
Thread size	M6	---

* Rated connection capacity based on EN 60999-1

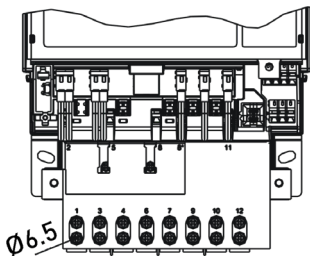
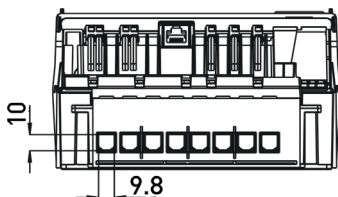

Path separator (accessory)

When testing meters, the voltage circuits are disconnected by a path separator

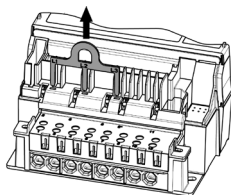



Remove the path separator again when resuming normal operation!

Readout battery (accessory)

The battery compartment is located in the sealable terminal cover. It can be fitted with a lithium battery (CR 2450, 3 V), which can be replaced when required.

CAUTION!

Risk of explosion if replaceable battery is not replaced properly!

The replaceable battery may only be inserted or removed by qualified personnel. Batteries can leak or self-ignite.

- Never short-circuit, damage, heat or force open batteries.

In delivery condition, the battery function is inactive.

1. Remove the battery from the holder in the terminal cover.
2. Turn the battery around and then insert it again. While doing so, check the terminal direction (see illustration in terminal cover).
3. Mount the terminal cover.

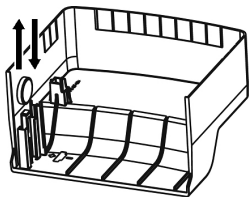

Terminal cover

To prevent any unauthorised access to the connection terminals, the terminal cover is attached with sealing screws and secured with seals.

ATTENTION!

Application of excessive torque will damage the device!

- Tighten the sealing screws to a maximum torque of 0.5 Nm.

Abbreviations

D0	Optical interface as per EN 62056-21
DIN	Deutsches Institut für Normung e.V. (German Standardisation Institute)
EN	European Norm
IEC	International Electrotechnical Commission
IP	Ingress Protection
LC	Liquid Crystal
LED	Light Emitting Diode
OBIS	Object Identification System
P	Active power
+P	Positive active power (power drawn by customer)
-P	Negative active power (power supplied by customer)
Q	Reactive power
+Q	Positive reactive power
-Q	Negative reactive power
SH	Selective main line protection
TAB	Technical Connection Rules for Power Installations
UC	Utilisation Category
OVC	Overvoltage Category

EU Declaration of Conformity

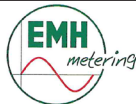

EU-Konformitätserklärung EU Declaration of Conformity

Der Hersteller
The manufacturer

EMH metering GmbH & Co. KG
Neu-Galliner Weg 1
19258 Gallin
GERMANY

erklärt hiermit in alleiniger Verantwortung, dass folgendes Produkt
declares under his sole responsibility that the following product

Produktbezeichnung: Elektromesszähler
Product designation: Electricity meter

Typenbezeichnung: NXT4-...
Type designation:

übereinstimmt mit den grundlegenden Anforderungen folgender EU-Richtlinien:
conforms to the essential requirements of the following EU directives:

2014/32/EU	Messgeräte (MID)	EU Amtsblatt L 96
2014/32/EU	<i>Measuring instruments (MID)</i>	<i>Official Journal of the EU L96</i>
2014/30/EU	Elektromagnetische Verträglichkeit (EMV)	EU Amtsblatt L 96
2014/30/EU	<i>Electromagnetic compatibility (EMC)</i>	<i>Official Journal of the EU L96</i>
2011/65/EU	Beschränkung der Verwendung bestimmter gefährlicher Stoffe (RoHS)	EU Amtsblatt L 174
2011/65/EU	<i>Restriction of the use of certain hazardous substances (RoHS)</i>	<i>Official Journal of the EU L174</i>

Im Rahmen der MID wurde die Konformität des Baumusters (Modul B) festgestellt und
Within the MID the conformity of the type (annex B) was attested and
die Konformitätsbewertung wurde nach Modul D durch den Hersteller vorgenommen:
the conformity assessment was performed by manufacturer according to annex D:

	Modul B (annex B)	Modul D (annex D)
Benannte Stelle (Name/Number): <i>Notified body (name/number):</i>	NMI/0122	PTB/0102
Zertifikats-Nummer: <i>Certificate number:</i>	T10592	DE-M-AQ-PTB026

Es wurden die folgenden harmonisierten Normen angewendet:
The following harmonized standards were applied:

MID:	EMV (EMC):	RoHS:
EN 50470-1:2006	EN 55032:2012/AC:2013	EN IEC 63000:2018
EN 50470-3:2006	EN 62052-11:2003+A1:2017	
	EN 62053-21:2003+A1:2017	
	EN 62053-23:2003+A1:2017	

Ort, Datum: Gallin, 17 NOV 2020
Place, Date:

A blue ink signature of Norbert Malek, written in a cursive style over a horizontal line.

Dipl.-Ing. Norbert Malek
Geschäftsführer
Managing director



The current EU Declaration of Conformity is available on the Internet site www.emh-metering.com in the "Products" area for the meter's product description.

