

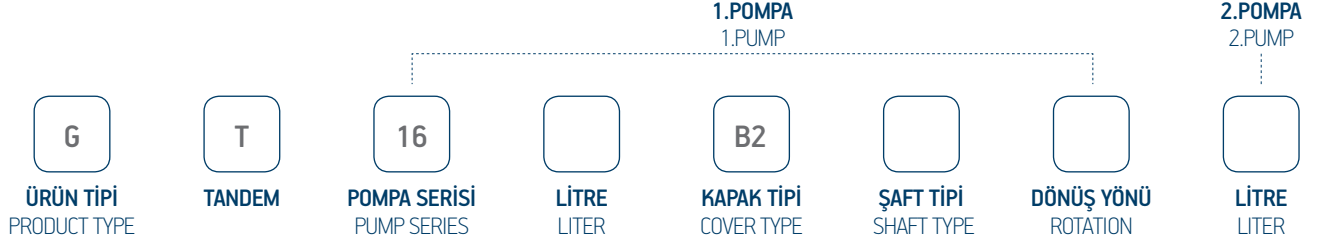







## TANDEM POMPA KODLAMA SİSTEMİ | TANDEM PUMP CODING SYSTEM



23	23 cm <sup>3</sup> /rev
32	32 cm <sup>3</sup> /rev
36	36 cm <sup>3</sup> /rev
37	37 cm <sup>3</sup> /rev
41	41 cm <sup>3</sup> /rev

<b>B2</b>	<b>2 Delikli SEA B</b> 2 Holes SEA B	
-----------	-----------------------------------------	-----------------------------------------------------------------------------------

<b>F5</b>	<b>13 TEETH</b> SAE J498B	
<b>F6</b>	<b>15 TEETH</b> SAE J498B	
<b>K1</b>	<b>6.35x6.35x25.4</b> Kamalı Şaft Keyed Shaft	
<b>K2</b>	<b>4.79x4.76x32</b> Kamalı Şaft Keyed Shaft	
<b>K3</b>	<b>6.35x6.35x31.8</b> Kamalı Şaft Keyed Shaft	

<b>1</b>	<b>SOL</b> LEFT	
<b>2</b>	<b>SAĞ</b> RIGHT	

<b>15</b>	<b>15 cm<sup>3</sup>/rev</b>
<b>23</b>	<b>23 cm<sup>3</sup>/rev</b>
<b>26</b>	<b>26 cm<sup>3</sup>/rev</b>
<b>29</b>	<b>29 cm<sup>3</sup>/rev</b>
<b>32</b>	<b>32 cm<sup>3</sup>/rev</b>
<b>33</b>	<b>33 cm<sup>3</sup>/rev</b>
<b>36</b>	<b>36 cm<sup>3</sup>/rev</b>
<b>41</b>	<b>41 cm<sup>3</sup>/rev</b>

### TEKNİK VERİLER | TECHNICAL DATA

#### TEK YÖNLÜ TANDEM DİŞLİ POMPA | SINGLE ROTATION TANDEM GEAR PUMP

Giriş Basıncı   Inlet Pressure		0.3÷ 2 bar	
Çalışma Viskozite Seviyesi   Operating Viscosity Range		-12:100 cSt	
Sıvı Sıcaklığı   Fluid Temperature		-40 °C+145 °C	
Çalışma Basıncı   Working Pressure	Kirlilik   Contamination		Filtre   Filter
	NAS 1638	ISO 4406	$\beta_x=75$
$\geq 200$ bar	11	20/17	25 $\mu\text{m}$
$\leq 200$ bar	12	21/18	40 $\mu\text{m}$

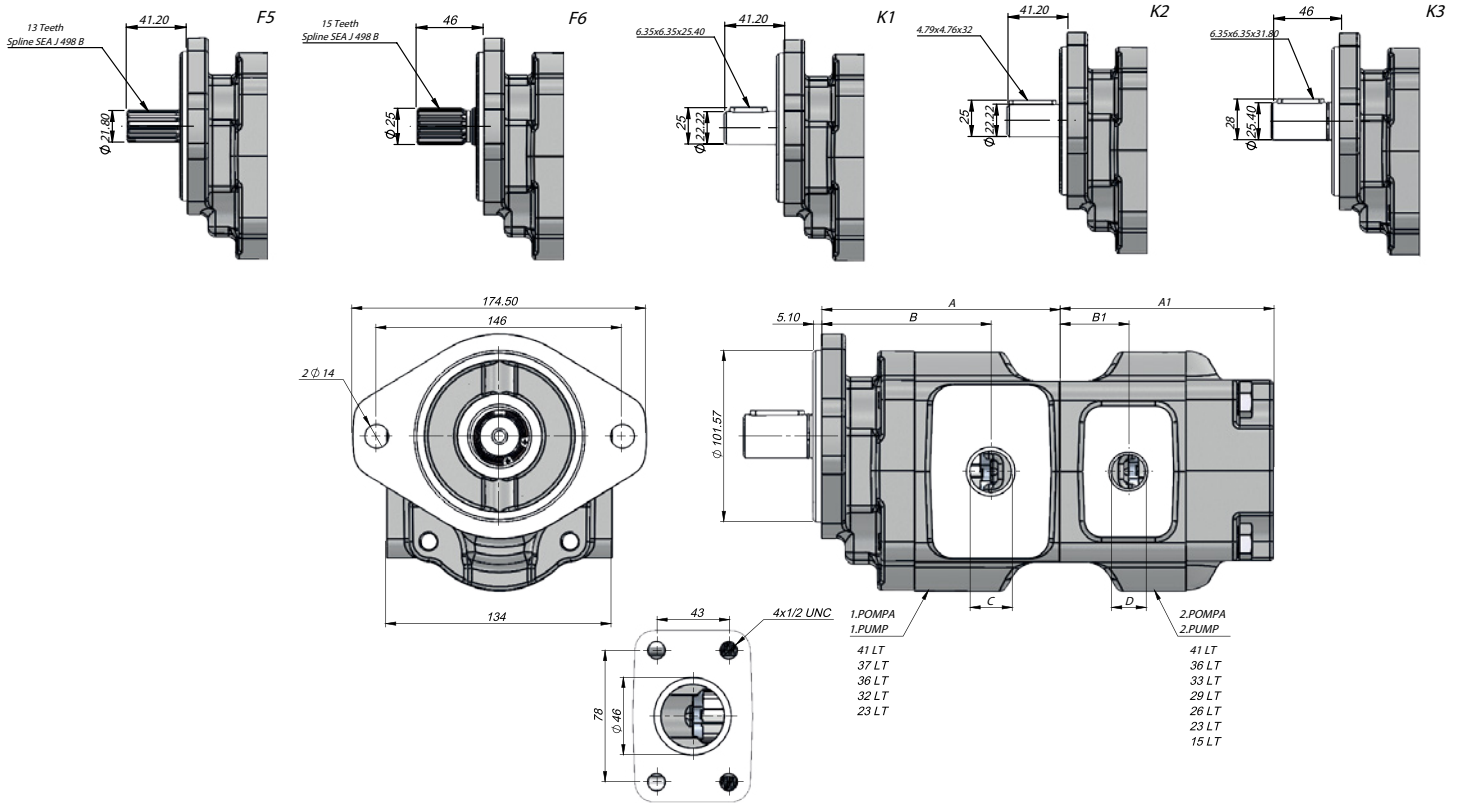

İletim Hacmi Displacement	Maks.Sürekli Basınç Max.Continuous Pressure	Min. Hız Min. Speed	Maks.Sürekli Hız Max.Continuous Speed	1.Pompa First Pump		2.Pompa Second Pump		Çıkış Outlet	
				A	B	A1	B1	C	D
(cm <sup>3</sup> /rev)	(100%)(BAR)	(RPM)	(RPM)	mm	mm	mm	mm	UNF	UNF
41	220	500	3500	147,5	106	-	-	1 1/16"	-
37	250			143	102	-	-	1 1/16"	-
36	275			142	101	-	-	1 1/16"	-
33				-	-	187	94	-	7/8"
32				127	86	-	-	1 1/16"	-
29				-	-	130,5	89,5	-	7/8"
26				-	-	127	86	-	7/8"
23				-	-	124	83	-	7/8"
15				-	-	-	-	-	-