

User Manual

Hybrid 2KW/3KW/5KW INVERTER / CHARGER

Table Of Contents

| | |
|---|-----------|
| ABOUT THIS MANUAL | 1 |
| Purpose | 1 |
| Scope | 1 |
| SAFETY INSTRUCTIONS..... | 1 |
| INTRODUCTION | 2 |
| Product Overview | 3 |
| INSTALLATION..... | 4 |
| Unpacking and Inspection | 4 |
| Preparation | 4 |
| Mounting the Unit..... | 4 |
| Battery Connection | 5 |
| AC Input/Output Connection | 6 |
| PV Connection..... | 7 |
| Communication Connection | 8 |
| Dry Contact Signal..... | 8 |
| OPERATION..... | 9 |
| Power ON/OFF | 9 |
| Operation and Display Panel..... | 9 |
| LCD Display Icons..... | 10 |
| LCD Setting..... | 11 |
| Display Setting | 18 |
| Operating Mode Description | 21 |
| SPECIFICATIONS | 25 |
| TROUBLE SHOOTING | 26 |
| Appendix I: Parallel function | 27 |
| Appendix II: Approximate Back-up Time Table..... | 43 |

ABOUT THIS MANUAL

Purpose

This manual describes the assembly, installation, operation and troubleshooting of this unit. Please read this manual carefully before installations and operations. Keep this manual for future reference.

Scope

This manual provides safety and installation guidelines as well as information on tools and wiring.

SAFETY INSTRUCTIONS



WARNING: This chapter contains important safety and operating instructions. Read and keep this manual for future reference.

1. Before using the unit, read all instructions and cautionary markings on the unit, the batteries and all appropriate sections of this manual.
2. **CAUTION** --To reduce risk of injury, charge only deep-cycle lead acid type rechargeable batteries. Other types of batteries may burst, causing personal injury and damage.
3. Do not disassemble the unit. Take it to a qualified service center when service or repair is required. Incorrect re-assembly may result in a risk of electric shock or fire.
4. To reduce risk of electric shock, disconnect all wirings before attempting any maintenance or cleaning. Turning off the unit will not reduce this risk.
5. **CAUTION** – Only qualified personnel can install this device with battery.
6. **NEVER** charge a frozen battery.
7. For optimum operation of this inverter/charger, please follow required spec to select appropriate cable size. It's very important to correctly operate this inverter/charger.
8. Be very cautious when working with metal tools on or around batteries. A potential risk exists to drop a tool to spark or short circuit batteries or other electrical parts and could cause an explosion.
9. Please strictly follow installation procedure when you want to disconnect AC or DC terminals. Please refer to INSTALLATION section of this manual for the details.
10. Fuses are provided as over-current protection for the battery supply.
11. GROUNDING INSTRUCTIONS -This inverter/charger should be connected to a permanent grounded wiring system. Be sure to comply with local requirements and regulation to install this inverter.
12. NEVER cause AC output and DC input short circuited. Do NOT connect to the mains when DC input short circuits.
13. **Warning!!** Only qualified service persons are able to service this device. If errors still persist after following troubleshooting table, please send this inverter/charger back to local dealer or service center for maintenance.

INTRODUCTION

This hybrid PV inverter can provide power to connected loads by utilizing PV power, utility power and battery power.

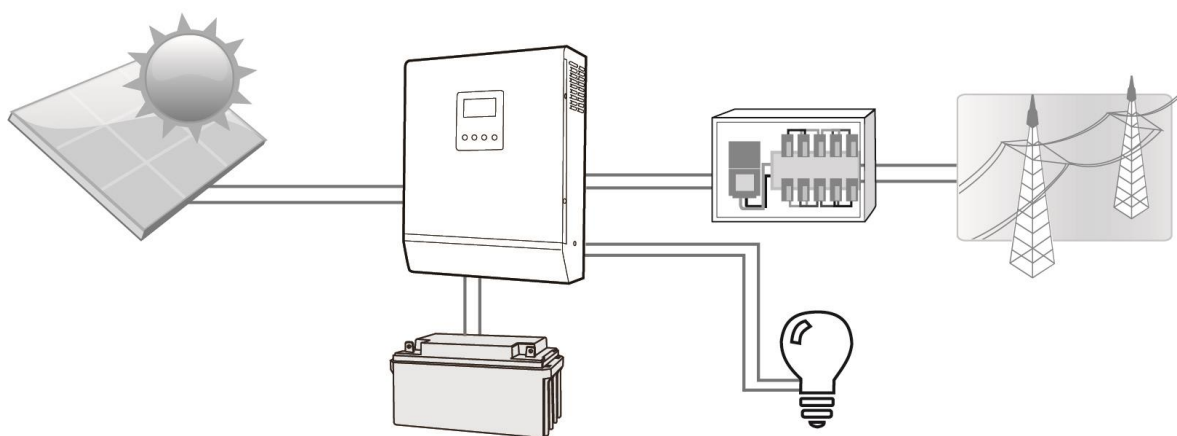
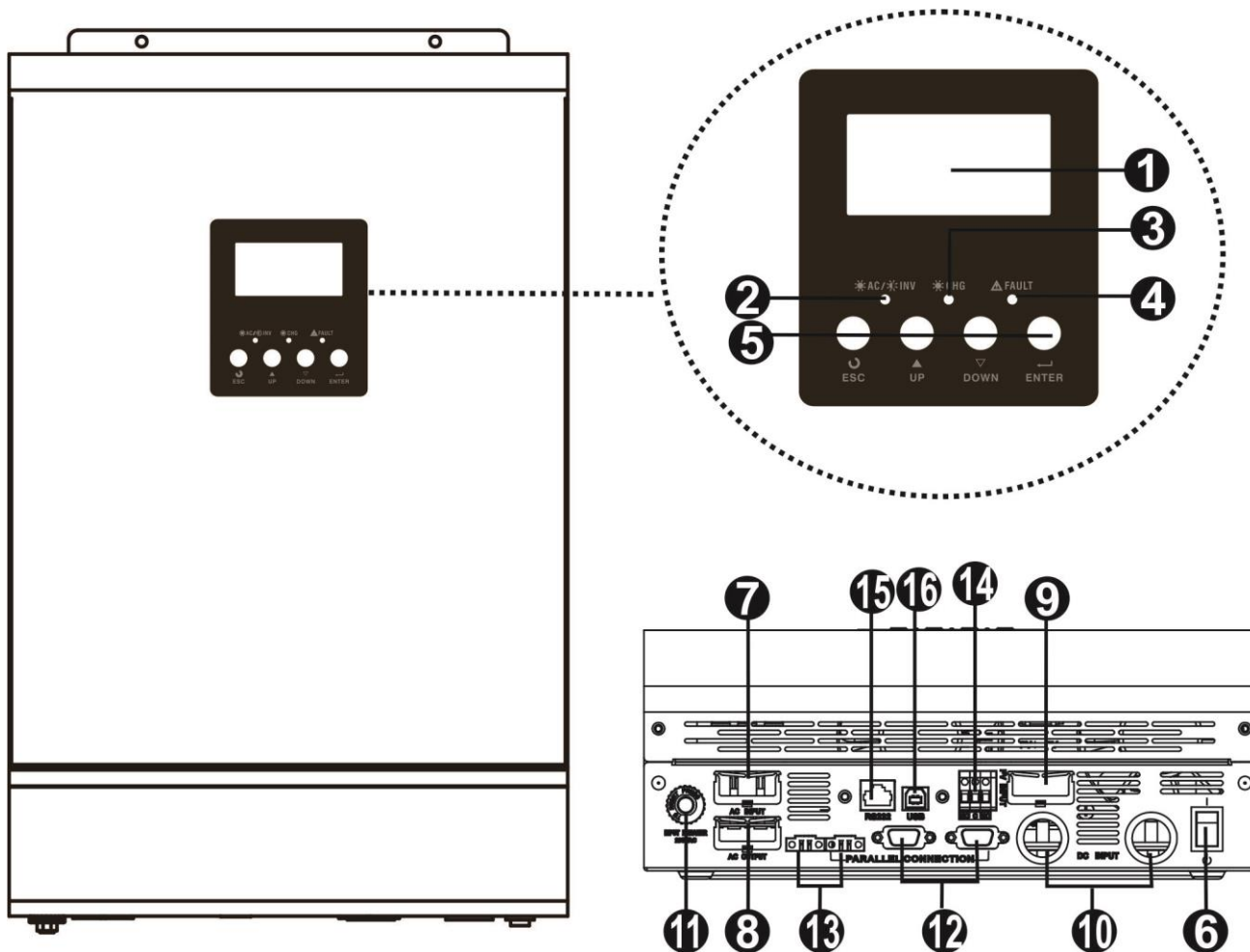

Figure 1 Basic hybrid PV System Overview

Depending on different power situations, this hybrid inverter is designed to generate continuous power from PV solar modules (solar panels), battery, and the utility. When MPP input voltage of PV modules is within acceptable range (see specification for the details), this inverter is able to generate power to feed the grid (utility) and charge battery. **Never connect the positive and negative terminals of the solar panel to the ground.** See Figure 1 for a simple diagram of a typical solar system with this hybrid inverter.

Product Overview



NOTE: For parallel model installation and operation, please check separate parallel installation guide for the details.

- | | |
|---|----------------------------------|
| 1. LCD display | 9. PV connectors |
| 2. Status indicator | 10. Battery connectors |
| 3. Charging indicator | 11. Circuit breaker |
| 4. Fault indicator | 12. Parallel communication cable |
| 5. Function buttons | 13. Current sharing cable |
| 6. Power on/off switch | 14. Dry contact |
| 7. Grid connectors | 15. RS-232 communication port |
| 8. AC output connectors (Load connection) | 16. USB communication port |

INSTALLATION

Unpacking and Inspection

Before installation, please inspect the unit. Be sure that nothing inside the package is damaged. You should have received the following items inside of package:

- The unit x 1
- User manual x 1
- Communication cable x 2
- Software CD x 1

Preparation

Before connecting all wirings, please take off bottom cover by removing two screws as shown below.

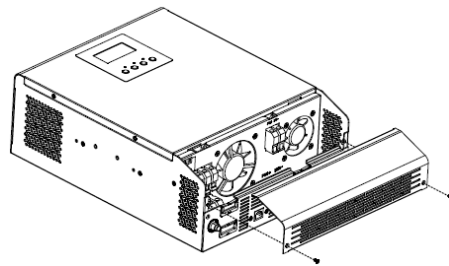

Mounting the Unit

Consider the following points before selecting where to install:

- Do not mount the inverter on flammable construction materials.
- Mount on a solid surface
- Install this inverter at eye level in order to allow the LCD display to be read at all times.
- The ambient temperature should be between 0°C and 55°C to ensure optimal operation.
- The recommended installation position is to be adhered to the wall vertically.
- Be sure to keep other objects and surfaces as shown in the right diagram to guarantee sufficient heat dissipation and to have enough space for removing wires.

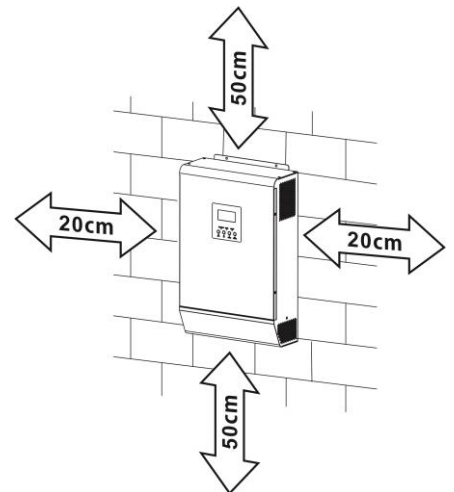

SUITABLE FOR MOUNTING ON CONCRETE OR OTHER NON-COMBUSTIBLE SURFACE ONLY.

Install the unit by screwing three screws. It's recommended to use M4 or M5 screws.

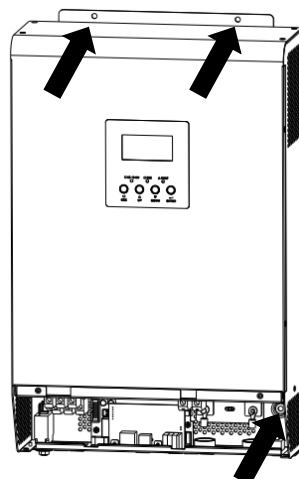

Battery Connection

CAUTION: For safety operation and regulation compliance, it's requested to install a separate DC over-current protector or disconnect device between battery and inverter. It may not be requested to have a disconnect device in some applications, however, it's still requested to have over-current protection installed. Please refer to typical amperage in below table as required fuse or breaker size.

WARNING! All wiring must be performed by a qualified personnel.

WARNING! It's very important for system safety and efficient operation to use appropriate cable for battery connection. To reduce risk of injury, please use the proper recommended cable and terminal size as below.

Ring terminal:

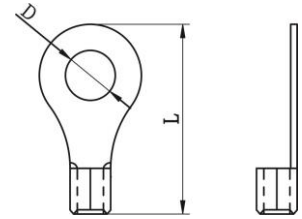

Recommended battery cable and terminal size:

| Model | Typical Amperage | Battery Capacity | Wire Size | Ring Terminal | | | Torque Value |
|-------|------------------|------------------|-----------|-----------------------|------------|--------|--------------|
| | | | | Cable mm ² | Dimensions | | |
| | | | | | D (mm) | L (mm) | |
| 2KW | 55A | 100AH | 1*6AWG | 14 | 6.4 | 33.2 | 2~3 Nm |
| 3KW | 82A | 200AH | 1*4AWG | 22 | 6.4 | 33.2 | 2~3 Nm |
| 5KW | 137A | 200AH | 1*2AWG | 38 | 6.4 | 33.2 | 2~3 Nm |

Please follow below steps to implement battery connection:

1. Assemble battery ring terminal based on recommended battery cable and terminal size.
2. Insert the ring terminal of battery cable flatly into battery connector of inverter and make sure the nuts are tightened with torque of 2-3 Nm. Make sure polarity at both the battery and the inverter/charge is correctly connected and ring terminals are tightly screwed to the battery terminals.

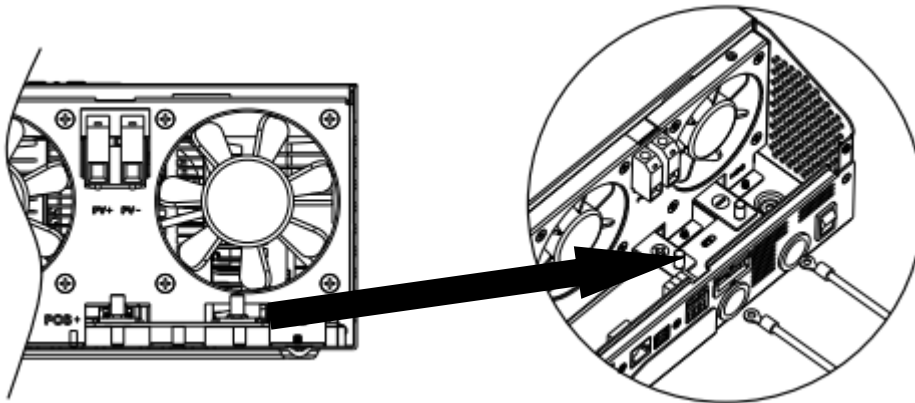

WARNING: Shock Hazard
 Installation must be performed with care due to high battery voltage in series.

CAUTION!! Do not place anything between the flat part of the inverter terminal and the ring terminal. Otherwise, overheating may occur.
CAUTION!! Do not apply anti-oxidant substance on the terminals before terminals are connected tightly.
CAUTION!! Before making the final DC connection or closing DC breaker/disconnector, be sure positive (+) must be connected to positive (+) and negative (-) must be connected to negative (-).

AC Input/Output Connection

CAUTION!! Before connecting to AC input power source, please install a **separate** AC breaker between inverter and AC input power source. This will ensure the inverter can be securely disconnected during maintenance and fully protected from over current of AC input.

CAUTION!! There are two terminal blocks with "IN" and "OUT" markings. Please do NOT mis-connect input and output connectors.

WARNING! All wiring must be performed by a qualified personnel.

WARNING! It's very important for system safety and efficient operation to use appropriate cable for AC input connection. To reduce risk of injury, please use the proper recommended cable size as below.

Suggested cable requirement for AC wires

| Model | Gauge | Torque Value |
|-------|--------|--------------|
| 2KW | 14 AWG | 0.8~ 1.0 Nm |
| 3KW | 12 AWG | 1.2~ 1.6 Nm |
| 5KW | 10 AWG | 1.2~ 1.6 Nm |

Please follow below steps to implement AC input/output connection:

1. Before making AC input/output connection, be sure to open DC protector or disconnecter first.
2. Remove insulation sleeve 10mm for six conductors. And shorten phase L and neutral conductor N 3 mm.
3. Insert AC input wires according to polarities indicated on terminal block and tighten the terminal screws. Be sure to connect PE protective conductor (⊕) first.

⊕ → **Ground (yellow-green)**

L → **LINE (brown or black)**

N → **Neutral (blue)**

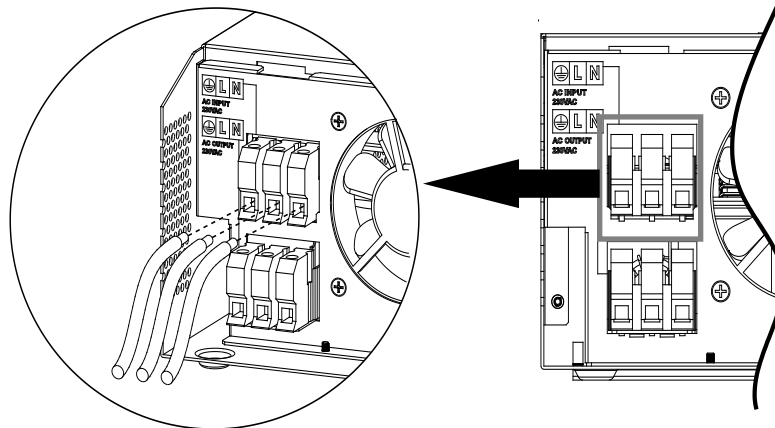

WARNING:

Be sure that AC power source is disconnected before attempting to hardwire it to the unit.

4. Then, insert AC output wires according to polarities indicated on terminal block and tighten terminal screws. Be sure to connect PE protective conductor (⊕) first.

⊕ → **Ground (yellow-green)**

L → **LINE (brown or black)**

N → **Neutral (blue)**

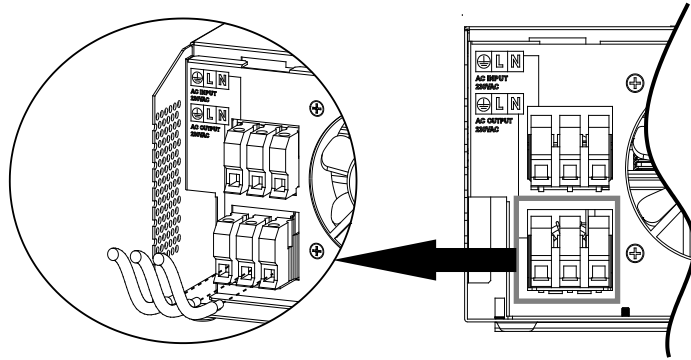

5. Make sure the wires are securely connected.

CAUTION: Important

Be sure to connect AC wires with correct polarity. If L and N wires are connected reversely, it may cause utility short-circuited when these inverters are worked in parallel operation.

CAUTION: Appliances such as air conditioner are required at least 2~3 minutes to restart because it's required to have enough time to balance refrigerant gas inside of circuits. If a power shortage occurs and recovers in a short time, it will cause damage to your connected appliances. To prevent this kind of damage, please check manufacturer of air conditioner if it's equipped with time-delay function before installation. Otherwise, this inverter/charger will trig overload fault and cut off output to protect your appliance but sometimes it still causes internal damage to the air conditioner.

PV Connection

CAUTION: Before connecting to PV modules, please install **separately** a DC circuit breaker between inverter and PV modules.

WARNING! All wiring must be performed by a qualified personnel.

WARNING: Please switch off the inverter before you connect PV modules. Otherwise, it will damage the inverter.

WARNING! It's very important for system safety and efficient operation to use appropriate cable for PV module connection. To reduce risk of injury, please use the proper recommended cable size as below.

| Model | Typical Amperage | Cable Size | Torque |
|-------|------------------|------------|-----------|
| 2KW | 13A | 12AWG | 2.0~2.4Nm |
| 3KW | 18A | 10AWG | 2.0~2.4Nm |
| 5KW | 18A | 10AWG | 2.0~2.4Nm |

PV Module Selection:

When selecting proper PV modules, please be sure to consider below parameters:

1. Open circuit Voltage (Voc) of PV modules not exceeds max. PV array open circuit voltage of inverter.
2. Open circuit Voltage (Voc) of PV modules should be higher than min. battery voltage.

| Solar Charging Mode | | | |
|------------------------------------|-----------|------------|-----|
| INVERTER MODEL | 2KW | 3KW | 5KW |
| Max. PV Array Open Circuit Voltage | 450 Vdc | | |
| PV Array MPPT Voltage Range | 90~430Vdc | 120~430Vdc | |
| MPP Number | 1 | | |

Please follow below steps to implement PV module connection:

1. Remove insulation sleeve 10 mm for positive and negative conductors.
2. Check correct polarity of connection cable from PV modules and PV input connectors. Then, connect positive pole (+) of connection cable to positive pole (+) of PV input connector. Connect negative pole (-) of connection

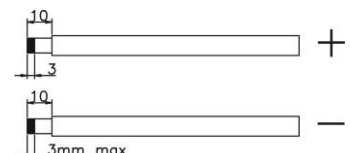

cable to negative pole (-) of PV input connector.

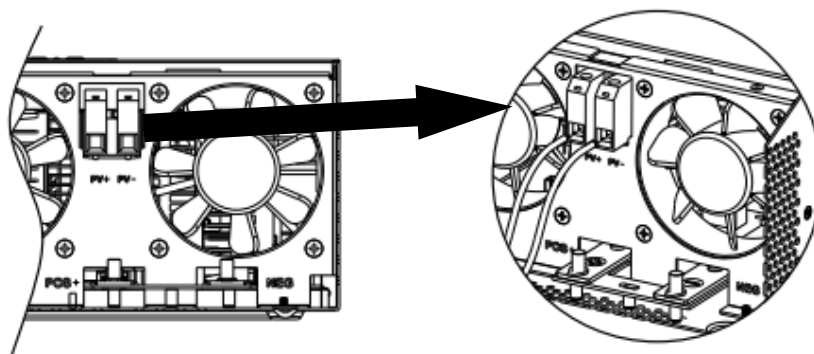

Recommended PV module Configuration

| PV Module Spec. (reference) - 250Wp - Vmp: 30.7Vdc - Imp: 8.15A - Voc: 37.4Vdc - Isc: 8.63A - Cells: 60 | Total solar input power | Solar input | Q'ty of modules |
|--|--------------------------------|--|------------------------|
| | 1500W | 6 pieces in series | 6 pcs |
| | 2000W | 8 pieces in series | 8 pcs |
| | 2750W | 11 pieces in series | 11 pcs |
| | 3000W | 6 pieces in series 2 strings in parallel | 12 pcs |
| | 4000W | 8 pieces in series 2 strings in parallel | 16 pcs |
| | 5000W | 10 pieces in series 2 strings in parallel | 20 pcs |

Communication Connection

Please use supplied communication cable to connect to inverter and PC. Insert bundled CD into a computer and follow on-screen instruction to install the monitoring software. For the detailed software operation, please check user manual of software inside of CD.

Dry Contact Signal

There is one dry contact (3A/250VAC) available on the rear panel. It could be used to deliver signal to external device when battery voltage reaches warning level.

| Unit Status | Condition | | Dry contact port:  | | |
|-------------|--|--|---|--------|-------|
| | | | NC & C | NO & C | |
| Power Off | Unit is off and no output is powered. | | Close | Open | |
| Power On | Output is powered from Utility. | | Close | Open | |
| | Output is powered from Battery or Solar. | Program 01 set as SUB | Battery voltage < Low DC warning voltage | Open | Close |
| | | | Battery voltage > Setting value in Program 21 or battery charging reaches floating stage | Close | Open |
| | Program 01 is set as SBU | | Battery voltage < Setting value in Program 20 | Open | Close |
| | | Battery voltage > Setting value in Program 21 or battery charging reaches floating stage | Close | Open | |

OPERATION

Power ON/OFF

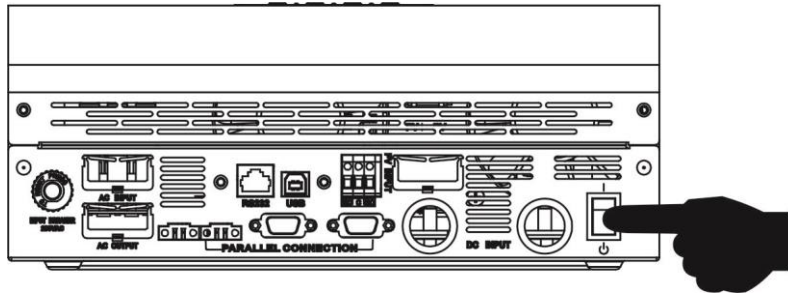

Once the unit has been properly installed and the batteries are connected well, simply press On/Off switch (located on the button of the case) to turn on the unit.

Operation and Display Panel

The operation and display panel, shown in below chart, is on the front panel of the inverter. It includes three indicators, four function keys and a LCD display, indicating the operating status and input/output power information.

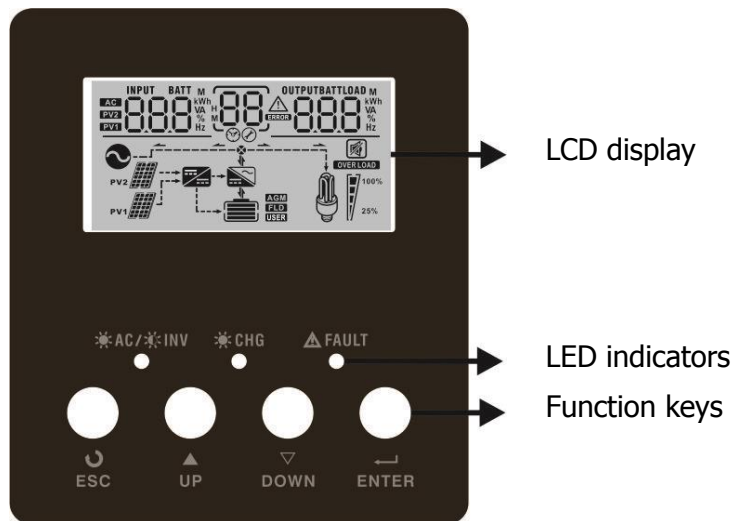

LED Indicator

| LED Indicator | | Messages | |
|---------------|-------|----------|---|
| ☀ AC / ☀ INV | Green | Solid On | Output is powered by utility in Line mode. |
| | | Flashing | Output is powered by battery or PV in battery mode. |
| ☀ CHG | Green | Solid On | Battery is fully charged. |
| | | Flashing | Battery is charging. |
| ⚠ FAULT | Red | Solid On | Fault occurs in the inverter. |
| | | Flashing | Warning condition occurs in the inverter. |



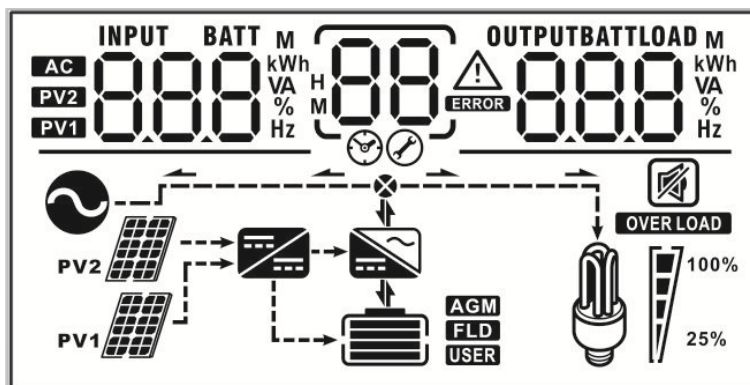

Function Keys

| Function Key | Description |
|--------------|--|
| ESC | To exit setting mode |
| UP | To go to previous selection |
| DOWN | To go to next selection |
| ENTER | To confirm the selection in setting mode or enter setting mode |

LCD Display Icons



| Icon | Function | | | |
|---|---|---------|---------|----------|
| Input source information | | | | |
| | Indicates the AC input | | | |
| | Indicates the 1 st PV panel input | | | |
| | Indicates the 2 nd PV panel input | | | |
| Left digital display information | | | | |
| | Indicate input voltage, input frequency, battery voltage, PV1 voltage, PV2 voltage, charger current | | | |
| Middle digital display information | | | | |
| | Indicates the setting programs. | | | |
| | Indicates the warning and fault codes. Warning: Flashing with warning code Fault: display with fault code | | | |
| Right digital display information | | | | |
| | Indicate the output voltage, output frequency, load percent, load VA, load W, PV1 charger power, PV2 charger power, DC discharging current. | | | |
| Battery information | | | | |
| | Indicates battery level by 0-24%, 25-49%, 50-74% and 75-100% and charging status. | | | |
| | Indicates the battery type: AGM, Flooded or User-defined battery. | | | |
| Load information | | | | |
| | Indicates overload. | | | |
| | Indicates the load level by 0-24%, 25-50%, 50-74%, and 75-100%. | | | |
| | 0%~25% | 25%~50% | 50%~75% | 75%~100% |
| | | | | |











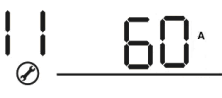

| Mode operation information | |
|---|---|
|  | Indicates unit connects to the mains. |
|  | Indicates unit connects to the 1 st PV panel |
|  | Indicates the solar charger is working |
|  | Indicates the DC/AC inverter circuit is working. |
| Mute operation | |
|  | Indicates unit alarm is disabled. |

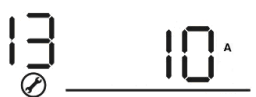

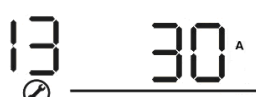



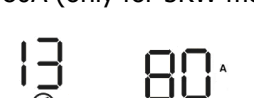

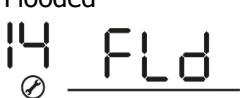
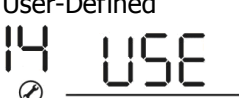





LCD Setting

After pressing and holding ENTER button for 3 seconds, the unit will enter setting mode. Press "UP" or "DOWN" button to select setting programs. And then, press "ENTER" button to confirm the selection or ESC button to exit.











| Program | Description | Selectable option | |
|---------|----------------------------------|--------------------------------|--|
| 00 | Exit setting mode | Escape 00 ESC | |
| 01 | Output source priority selection | 01 SUB | Solar energy provides power to the loads as first priority. If solar energy is not sufficient to power all connected loads, Utility energy will supply power to the loads at the same time. |
| | | 01 SBU | Solar energy provides power to the loads as first priority. If solar energy is not sufficient to power all connected loads, battery energy will supply power to the loads at the same time. Utility provides power to the loads only when battery voltage drops to either low-level warning voltage or the setting point in program 20 or solar and battery is not sufficient. |
| 02 | AC input voltage range | Appliances (default) 02 APL | If selected, acceptable AC input voltage range will be within 90-280VAC. |
| | | UPS | If selected, acceptable AC input voltage range will be within 170-280VAC. |

| | | | |
|----|---|--|---|
| | | 02 <u>UPS</u> | |
| 03 | Output voltage | 220Vac 03 <u>220^v</u> | 230V (Default) 03 <u>230^v</u> |
| | | 240Vac 03 <u>240^v</u> | |
| 04 | Output frequency | 50Hz (default) 04 <u>50^{Hz}</u> | 60Hz 04 <u>60^{Hz}</u> |
| 05 | Solar supply priority | 05 <u>BLU</u> | Solar energy provides power to charge battery as first priority. |
| | | 05 <u>LBU</u> | Solar energy provides power to the loads as first priority. |
| 06 | Overload bypass: When enabled, the unit will transfer to line mode if overload occurs in battery mode. | Bypass disable (default) 06 <u>byd</u> | Bypass enable 06 <u>byE</u> |
| 07 | Auto restart when overload occurs | Restart disable (default) 07 <u>ltd</u> | Restart enable 07 <u>lTE</u> |
| 08 | Auto restart when over temperature occurs | Restart disable (default) 08 <u>etd</u> | Restart enable 08 <u>etE</u> |
| 09 | Solar or battery energy feed to grid configuration | 09 <u>Grid</u> | Solar or battery energy feed to grid disable. |
| | | 09 <u>GrE</u> | Solar or battery energy feed to grid enable. |
| 10 | Charger source priority: To configure charger source priority | If this inverter/charger is working in Line, Standby or Fault mode, charger source can be programmed as below: | |
| | | Solar first 10 <u>CS0</u> | Solar energy will charge battery as first priority. Utility will charge battery only when solar energy is not available. |
| | | Solar and Utility (default) | Solar energy and utility will charge battery at the same time. |

| | | | |
|----|---|--|---|
| | |  | |
| | | <p>Only Solar</p>  | Solar energy will be the only charger source no matter utility is available or not. |
| | | If this inverter/charger is working in Battery mode or Power saving mode, only solar energy can charge battery. Solar energy will charge battery if it's available and sufficient. | |
| 11 | Maximum charging current: To configure total charging current for solar and utility chargers. (Max. charging current = utility charging current + solar charging current) | <p>60A (default)</p>  | <p>For 2KW/3KW models, setting range is from 10A to 60A. For 5KW model, setting range is from 10A to 80A. Increment of each click is 10A.</p> |
| 13 | Maximum utility charging current | <p>2A</p>  | <p>10A</p>  |
| | | <p>20A</p>  | <p>30A (default)</p>  |
| | | <p>40A</p>  | <p>50A</p>  |
| | | <p>60A</p>  | <p>70A (only for 5KW model)</p>  |
| | | <p>80A (only for 5KW model)</p>  | |
| 14 | Battery type | <p>AGM (default)</p>  | <p>Flooded</p>  |
| | | <p>User-Defined</p>  | <p>If "User-Defined" is selected, battery charge voltage and low DC cut-off voltage can be set up in program 17, 18 and 19.</p> |

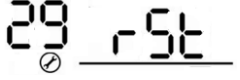
| | | | |
|----|---|---|--|
| 17 | Bulk charging voltage (C.V voltage) | Default setting: 56.4V  | |
| | | If self-defined is selected in program 14, this program can be set up. Setting range is from 48.0V to 64.0V. Increment of each click is 0.1V. | |
| 18 | Floating charging voltage | Default setting: 54.0V  | |
| | | If self-defined is selected in program 14, this program can be set up. Setting range is from 48.0V to 60.0V. Increment of each click is 0.1V. | |
| 19 | Low DC cut off battery voltage setting | Default setting: 40.8V  | |
| | | If self-defined is selected in program 14, this program can be set up. Setting range is from 40.8V to 48.0V. Increment of each click is 0.1V. Low DC cut-off voltage will be fixed to setting value no matter what percentage of load is connected. | |
| 20 | Battery stop discharging voltage when grid is available | 44.0V  | 45.0V  |
| | | 46.0V (default)  | 47.0V  |
| | | 48.0V  | 49.0V  |
| | | 50.0V  | 51.0V  |
| | | | |
| 21 | Battery stop charging voltage when grid is available | Battery fully charged  | 48.0V  |
| | | 49.0V  | 50.0V  |

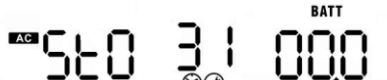

| | | | |
|----|--|--|---|
| | | 51.0V 21 ^{BATT} 510 v | 52.0V 21 ^{BATT} 520 v |
| | | 53.0V 21 ^{BATT} 530 v | 54.0V 21 ^{BATT} 540 v |
| | | 55.0V 21 ^{BATT} 550 v | 56.0V 21 ^{BATT} 560 v |
| 21 | Battery stop charging voltage when grid is available | 57.0V 21 ^{BATT} 570 v | 58.0V 21 ^{BATT} 580 v |
| 22 | Auto return to default display screen | Return to default display screen (default) 22 ESP | If selected, no matter how users switch display screen, it will automatically return to default display screen (Input voltage /output voltage) after no button is pressed for 1 minute. |
| | | Stay at latest screen 22 LEP | If selected, the display screen will stay at latest screen user finally switches. |
| 23 | Backlight control | Backlight on (default) 23 LON | Backlight off 23 LOF |
| 24 | Alarm control | Alarm on (default) 24 BON | Alarm off 24 BOF |
| 25 | Beeps while primary source is interrupted | Alarm on (default) 25 AON | Alarm off 25 AOF |
| 27 | Record Fault code | Record enable(default) 27 FEN | Record disable 27 FDS |

| | | | |
|----|--|---|--|
| 28 | AC output mode *This setting is only available when the inverter is in standby mode (Switch off). | Single: This inverter is used in single phase application.  | Parallel: This inverter is operated in parallel system.  |
| | | L1 phase  | The inverter is operated in L1 phase in 3-phase application. |
| | | L2 phase  | The inverter is operated in L2 phase in 3-phase application. |
| | | L3 phase  | The inverter is operated in L3 phase in 3-phase application. |
| 29 | Reset PV energy storage | Not reset(Default)  | Reset  |
| 30 | Start charging time for AC charger | 00:00 (Default)  The setting range of start charging time for AC charger is from 00:00 to 23:00, increment of each click is 1 hour. | |
| 31 | Stop charging time for AC charger | 00:00 (Default)  The setting range of stop charging time for AC charger is from 00:00 to 23:00, increment of each click is 1 hour. | |
| 32 | Scheduled time for AC output on | 00:00 (Default)  The setting range of scheduled Time for AC output on is from 00:00 to 23:00, increment of each click is 1 hour. | |
| 33 | Scheduled time for AC output off | 00:00(Default)  The setting range of scheduled Time for AC output off is from 00:00 to 23:00, increment of each click is 1 hour. | |

| | | | |
|----|------------------------------------|--------------------------|---|
| 34 | Set country customized regulations | India(Default) 34 IND | If selected, acceptable feed-in grid voltage range will be 195.5~253VAC. Acceptable feed-in grid frequency range will be 49~51Hz. |
| | | Germany 34 GEn | If selected, acceptable feed-in grid voltage range will be 184~264.5VAC. Acceptable feed-in grid frequency range will be 47.5~51.5Hz. |
| | | South America 34 SAAd | If selected, acceptable feed-in grid voltage range will be 184~264.5VAC. Acceptable feed-in grid frequency range will be 57~62Hz. |
| 95 | Time setting – Minute | min 95 00 | For minute setting, the range is from 00 to 59. |
| 96 | Time setting – Hour | hou 96 00 | For hour setting, the range is from 00 to 23. |
| 97 | Time setting– Day | dat 97 01 | For day setting, the range is from 00 to 31. |
| 98 | Time setting– Month | mon 98 01 | For month setting, the range is from 01 to 12. |
| 99 | Time setting – Year | yea 99 16 | For year setting, the range is from 16 to 99. |

Display Setting

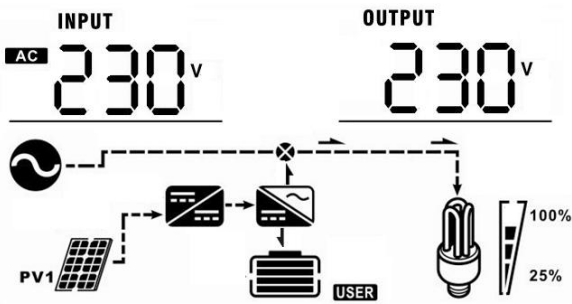
The LCD display information will be switched in turns by pressing "UP" or "DOWN" key. The selectable information is switched as below order: input voltage, input frequency, PV voltage, charging current, battery voltage, output voltage, output frequency, load percentage, load in Watt, load in VA, load in Watt, DC discharging current, main board firmware version and SCC firmware version.

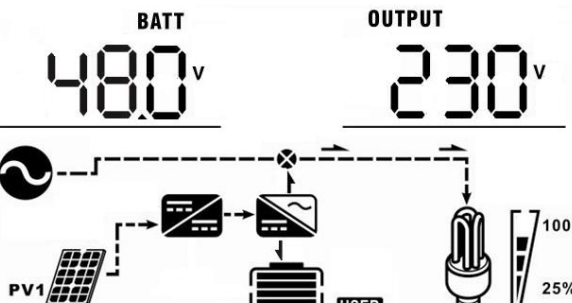
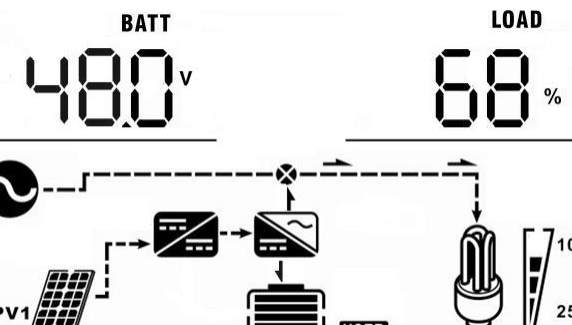

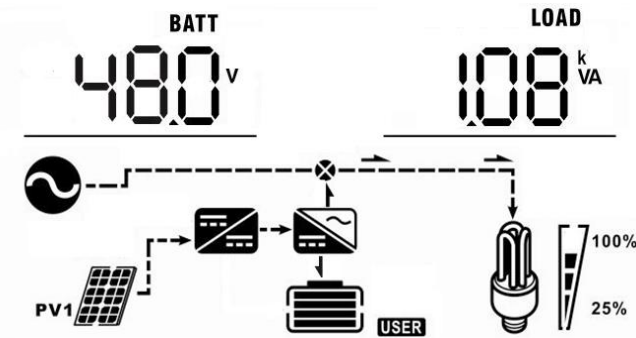
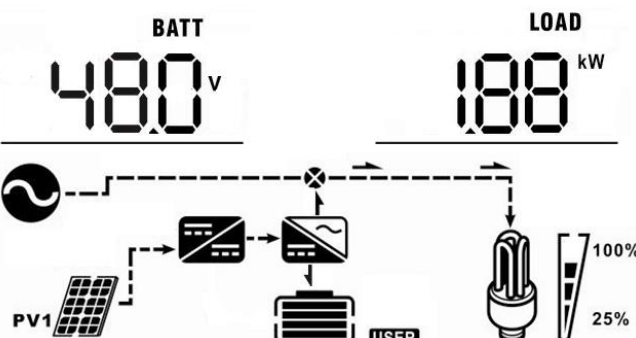
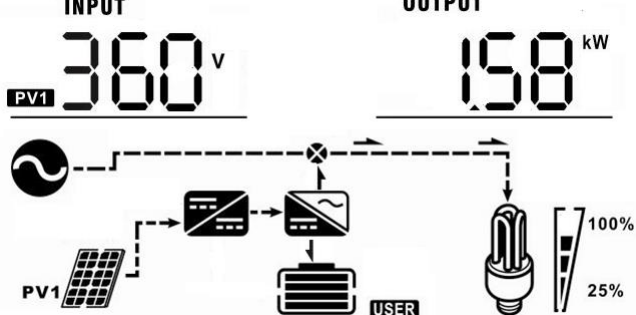
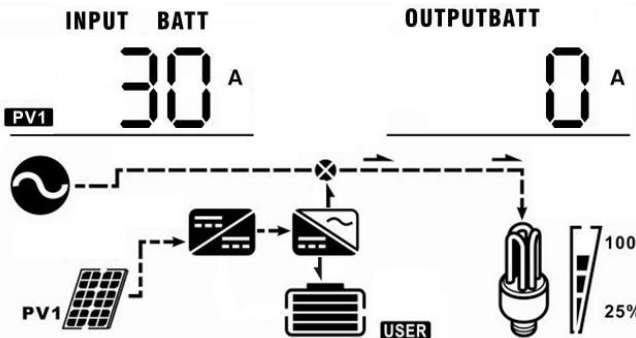
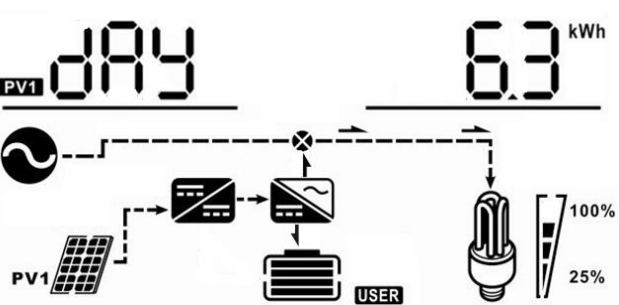

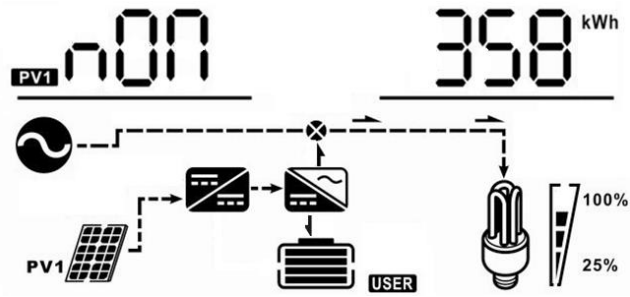
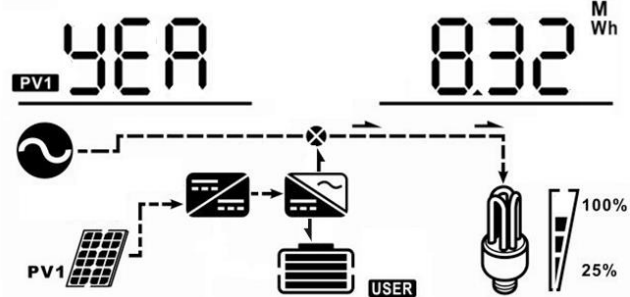
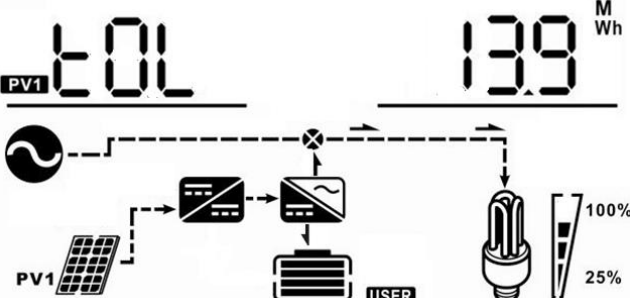
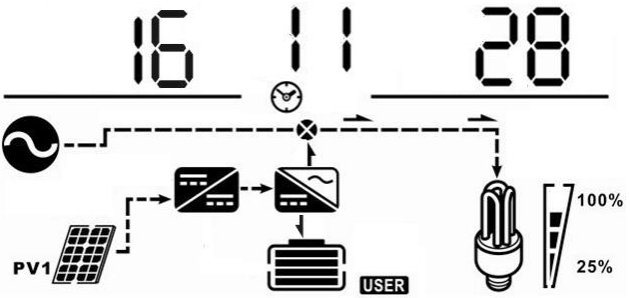
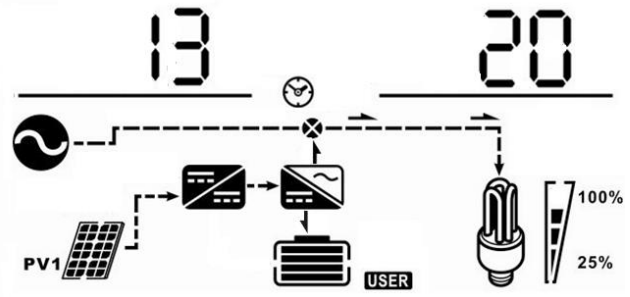
| Select item | LCD display |
|--|--|
| Input voltage and output voltage (Default Display Screen) | <p>Input Voltage=230V, output voltage=230V</p>  |
| Input frequency and output frequency | <p>Input frequency=50.0Hz, output frequency=50.0Hz</p>  |
| Battery voltage and output voltage | <p>Battery Voltage=48.0V, output voltage=230V</p>  |
| Battery voltage and load percentage | <p>Battery Voltage=48.0V, load percentage = 68%</p>  |

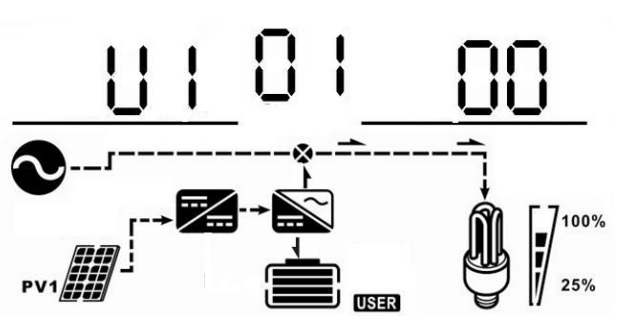
| | |
|---|--|
| <p>Battery voltage and load in VA</p> | <p>Battery Voltage=48.0V, load in VA=1.08kVA</p>  |
| <p>Battery voltage and load in Watt</p> | <p>Battery Voltage=48.0V, load in Watt=1.88kW</p>  |
| <p>PV1 voltage and PV1 charger power</p> | <p>PV1 Voltage=360V, charging power=1.58kW</p>  |
| <p>Charger current and DC discharging current</p> | <p>Charging current=30A, discharging current=0A</p>  |
| <p>PV energy generated today</p> | <p>Today energy = 6.3kWh</p>  |

| | |
|---------------------------------------|---|
| <p>PV energy generated this month</p> | <p>This month energy = 358kWh.</p>  |
| <p>PV energy generated this year</p> | <p>This year energy = 8.32MWh</p>  |
| <p>PV energy generated totally</p> | <p>Total energy = 13.9MWh</p>  |
| <p>Real date</p> | <p>Real date Nov 28, 2016.</p>  |
| <p>Real time</p> | <p>Real time 13:20.</p>  |

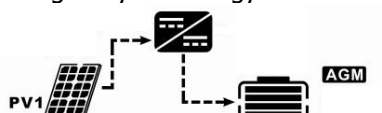
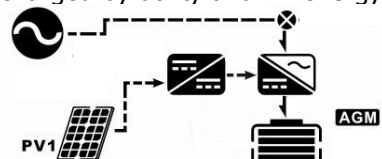
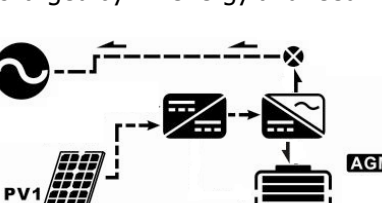
| | |
|-----------------------------|--|
| Main board firmware version | Version 00001.00  |
|-----------------------------|--|

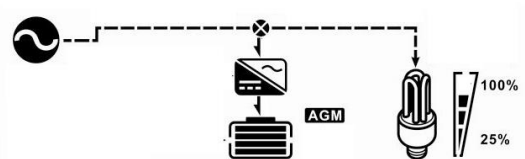









Operating Mode Description

| Operating mode | Behaviors | LCD display |
|--|---|---|
| Standby mode Note: *Standby mode: The inverter is not turned on yet but at this time, the inverter can charge battery without AC output. *Power saving mode: If enabled, the output of inverter will be off when connected load is pretty low or not detected. | No output power, solar or utility charger available | Battery is charged by utility.  |
| | | Battery is charged by PV energy.  |
| | | Battery is charged by utility and PV energy.  |
| | | Battery is charged by PV energy and feed PV energy to grid.  |
| | | No charging.  |
| Line mode | Output power from utility. Charger available | Utility charges battery and provides power to load.  |
| | | Utility and battery power provide power to load.  |















| | | |
|--------------|--|--|
| Line mode | Output power from utility. Charger available | <p>PV energy, battery power and utility provide power to load.</p> |
| | Output power from utility. Charger available | <p>PV energy and utility charge battery, and utility provides power to load.</p> |
| | | <p>PV energy charges battery, utility and PV energy provide power to the load.</p> |
| | | <p>PV energy charges battery, PV energy provides power to the load and feeds remaining energy to the grid.</p> |
| Battery mode | Output power from battery or PV | <p>PV energy and battery energy supply power to the load.</p> |
| | | <p>PV energy charges battery and provides power to the load.</p> |
| | | <p>Battery provides power to the load.</p> |
| Only PV mode | Output power from PV | <p>PV provides power to the load.</p> |

| | | |
|--|--------------------------------|---|
| <p>Fault mode</p> <p>Note: *Fault mode: Errors are caused by inside circuit error or external reasons such as over temperature, output short circuited and so on.</p> | <p>No output, no charging.</p> | <p>No charging.</p>  |
|--|--------------------------------|---|

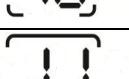
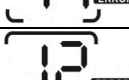
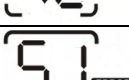
Warning Indicator

| Warning Code | Warning Event | Icon flashing |
|--------------|--------------------------|--|
| 01 | Fan locked |  |
| 02 | Over temperature |  |
| 03 | Battery over charged |  |
| 04 | Low battery |  |
| 07 | Overload |    |
| 10 | Inverter power derating |  |
| 15 | PV is weak |  |
| 19 | Battery is not connected |  |

Faults Reference Code

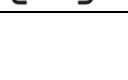
| Fault Code | Fault Event | Icon on |
|------------|-----------------------------|---|
| 01 | Fan locked |  |
| 02 | Over temperature |  |
| 03 | Battery voltage is too high |  |
| 04 | Battery voltage is too low |  |
| 05 | Output short circuited |  |
| 06 | Output voltage abnormal |  |
| 07 | Over load time out |  |
| 08 | Bus voltage is too high |  |
| 09 | Bus soft start failed |  |
| 10 | PV current over |  |
| 11 | PV voltage over |  |
| 12 | Charge current over |  |
| 51 | Over current or surge |  |
| 52 | Bus voltage is too low |  |
| 53 | Inverter soft start failed |  |
| 55 | Over DC offset in AC output |  |
| 56 | Battery disconnected |  |
| 57 | Current sensor failed |  |
| 58 | Output voltage is too low |  |

SPECIFICATIONS

| MODEL | 2KW | 3KW | 5KW |
|---------------------------------------|---|-----------------|-------|
| RATED OUPUT POWER | 2000W | 3000W | 5000W |
| PV INPUT (DC) | | | |
| Max. PV Power | 3000W | 4000W | 5000W |
| Max. PV Array Open Circuit Voltage | 450 VDC | | |
| MPPT Range @ Operating Voltage | 90 VDC~430 VDC | 120 VDC~430 VDC | |
| Number of MPP Tracker | 1 | | |
| GRID-TIE OPERATION | | | |
| GRID OUTPUT (AC) | | | |
| Nominal Output Voltage | 220/230/240 VAC | | |
| Feed-in Grid Voltage Range | 195.5~253 VAC @India regulation 184 ~ 264.5 VAC @Germany regulation 184 ~ 264.5 VAC @South America regulation | | |
| Feed-in Grid Frequency Range | 49~51Hz @India regulation 47.5~51.5Hz @Germany regulation 57~62Hz @South America | | |
| Nominal Output Current | 8.7A | 13A | 21.7A |
| Power Factor Range | >0.99 | | |
| Maximum Conversion Efficiency (DC/AC) | 95% | | |
| OFF-GRID, HYBRID OPERATION | | | |
| GRID INPUT | | | |
| Acceptable Input Voltage Range | 90 - 280 VAC or 170 - 280 VAC | | |
| Frequency Range | 50 Hz/60 Hz (Auto sensing) | | |
| Rating of AC Transfer Relay | 30A | 40A | |
| BATTERY MODE OUTPUT (AC) | | | |
| Nominal Output Voltage | 220/230/240 VAC | | |
| Output Waveform | Pure Sine Wave | | |
| Efficiency (DC to AC) | 93% | | |
| BATTERY & CHARGER | | | |
| Nominal DC Voltage | 48 VDC | | |
| Maximum Charging Current (from Grid) | 60A | 80A | |
| Maximum Charging Current (from PV) | 60A | 80A | |
| Maximum Charging Current | 60A | 80A | |
| GENERAL | | | |
| Dimension, D X W X H (mm) | 120 x 295 x 468 | | |
| Net Weight (kgs) | 11 | 11 | 12 |
| INTERFACE | | | |
| Parallel-able | Yes | | |
| External Safety Box (Optional) | Yes | | |
| Communication | USB or RS232/Dry-Contact | | |
| ENVIRONMENT | | | |
| Humidity | 0 ~ 90% RH (No condensing) | | |
| Operating Temperature | -10°C to 50°C | | |

TROUBLE SHOOTING

| Problem | LCD/LED/Buzzer | Explanation / Possible cause | What to do |
|---|---|---|--|
| Unit shuts down automatically during startup process. | LCD/LEDs and buzzer will be active for 3 seconds and then complete off. | The battery voltage is too low (<1.91V/Cell) | 1. Re-charge battery. 2. Replace battery. |
| No response after power on. | No indication. | 1. The battery voltage is far too low. (<1.4V/Cell) 2. Battery polarity is connected reversed. | 1. Check if batteries and the wiring are connected well. 2. Re-charge battery. 3. Replace battery. |
| Mains exist but the unit works in battery mode. | Input voltage is displayed as 0 on the LCD and green LED is flashing. | Input protector is tripped | Check if AC breaker is tripped and AC wiring is connected well. |
| | Green LED is flashing. | Insufficient quality of AC power. (Shore or Generator) | 1. Check if AC wires are too thin and/or too long. 2. Check if generator (if applied) is working well or if input voltage range setting is correct. (UPS→Appliance) |
| | Green LED is flashing. | Set "Solar First" as the priority of output source. | Change output source priority to Utility first. |
| When the unit is turned on, internal relay is switched on and off repeatedly. | LCD display and LEDs are flashing | Battery is disconnected. | Check if battery wires are connected well. |
| Buzzer beeps continuously and red LED is on. | Fault code 07 | Overload error. The inverter is overload 110% and time is up. | Reduce the connected load by switching off some equipment. |
| | Fault code 05 | Output short circuited. | Check if wiring is connected well and remove abnormal load. |
| | | Temperature of internal converter component is over 120°C. | Check whether the air flow of the unit is blocked or whether the ambient temperature is too high. |
| | Fault code 02 | Internal temperature of inverter component is over 100°C. | |
| | Fault code 03 | Battery is over-charged. | Return to repair center. |
| | | The battery voltage is too high. | Check if spec and quantity of batteries are meet requirements. |
| | Fault code 01 | Fan fault | Replace the fan. |
| | Fault code 06/58 | Output abnormal (Inverter voltage below than 190Vac or is higher than 260Vac) | 1. Reduce the connected load. 2. Return to repair center |
| | Fault code 08/09/53/57 | Internal components failed. | Return to repair center. |
| | Fault code 10 | Surge | Restart the unit, if the error happens again, please return to repair center. |
| | Fault code 12 | DC/DC over current or surge. | |
| | Fault code 51 | Over current or surge. | |
| | Fault code 52 | Bus voltage is too low. | |
| | Fault code 55 | Output voltage is unbalanced. | |
| Fault code 56 | Battery is not connected well or fuse is burnt. | If the battery is connected well, please return to repair center. | |
| Fault code 11 | Solar input voltage is more than 450V. | Solar input voltage is more than 450V. | |

Appendix I: Parallel function

1. Introduction

This inverter can be used in parallel with two different operation modes.

1. Parallel operation in single phase with up to 9 units. The supported maximum output power for 2KW is 18KW/18KVA, for 3KW is 27KW/27KVA and for 5KW is 45KW/45KVA.
2. Maximum nine units work together to support three-phase equipment. Seven units support one phase maximum. For 2KW, the supported maximum output power is 18KW/18KVA and one phase can be up to 14KW/14KVA. For 3KW, the supported maximum output power is 27KW/27KVA and one phase can be up to 21KW/21KVA. For 5KW, the supported maximum output power is 45KW/45KVA and one phase can be up to 35KW/35KVA.

NOTE: If this unit is bundled with share current cable and parallel cable, this inverter is default supported parallel operation. You may skip section 3. If not, please purchase parallel kit and install this unit by following instruction from professional technical personnel in local dealer.

2. Package Contents

In parallel kit, you will find the following items in the package:

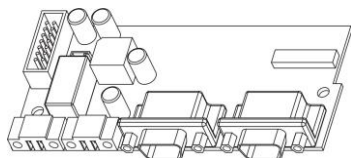

Parallel board



Parallel communication cable



Current sharing cable

3. Parallel board installation

Step 1: Remove wire cover by unscrewing all screws.

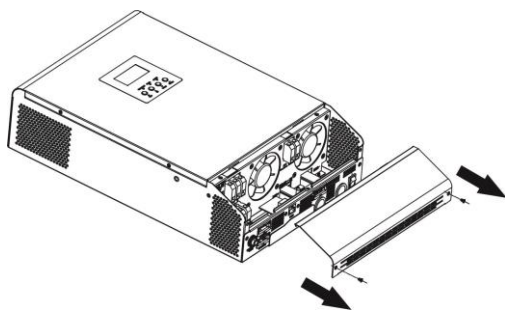

Step 2: Remove communication board by unscrewing two screws as below chart.

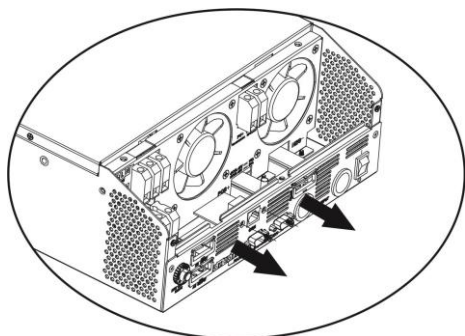

Step 3: Remove two screws as below chart and remove 2-pin and 14-pin cables. Take out the board under the communication board.

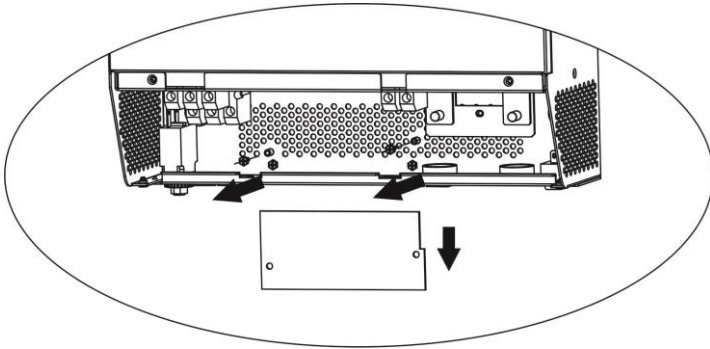

Step 4: Remove two screws as below chart to take out cover of parallel communication.

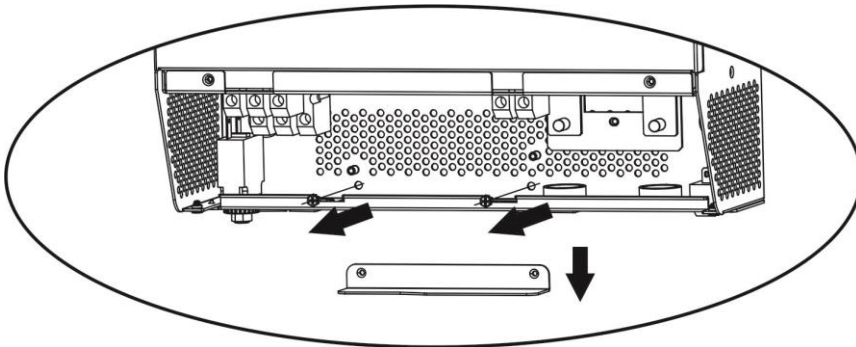

Step 5: Install new parallel board with 2 screws tightly.

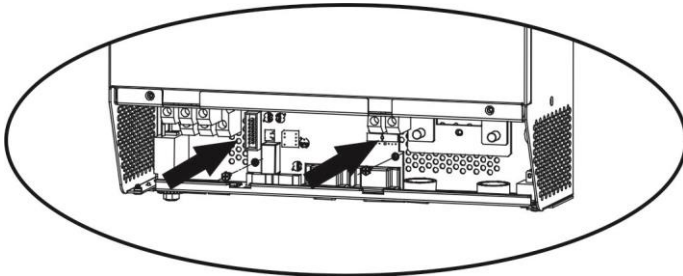

Step 6: Re-connect 2-pin and 14-pin to original position.

Parallel board

Communication board

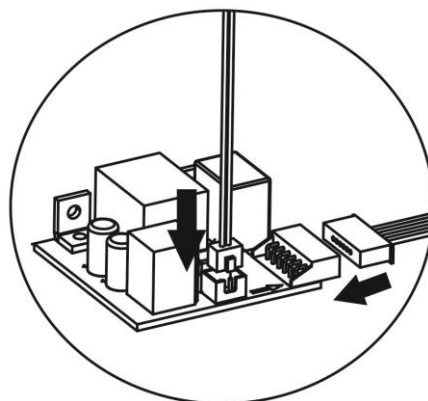
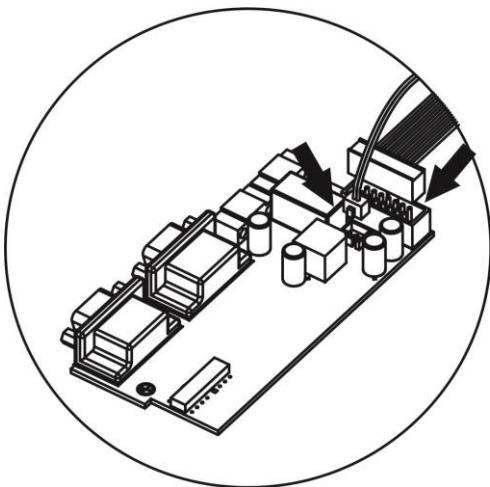

Step 7: Put communication board back to the unit.

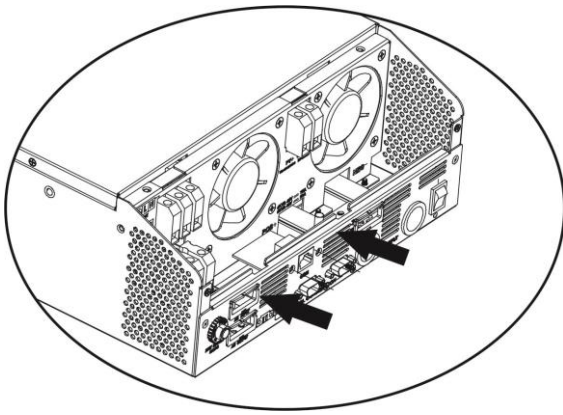

Step 8: Put wire cover back to the unit. Now the inverter is providing parallel operation function.

4. Mounting the Unit

When installing multiple units, please follow below chart.

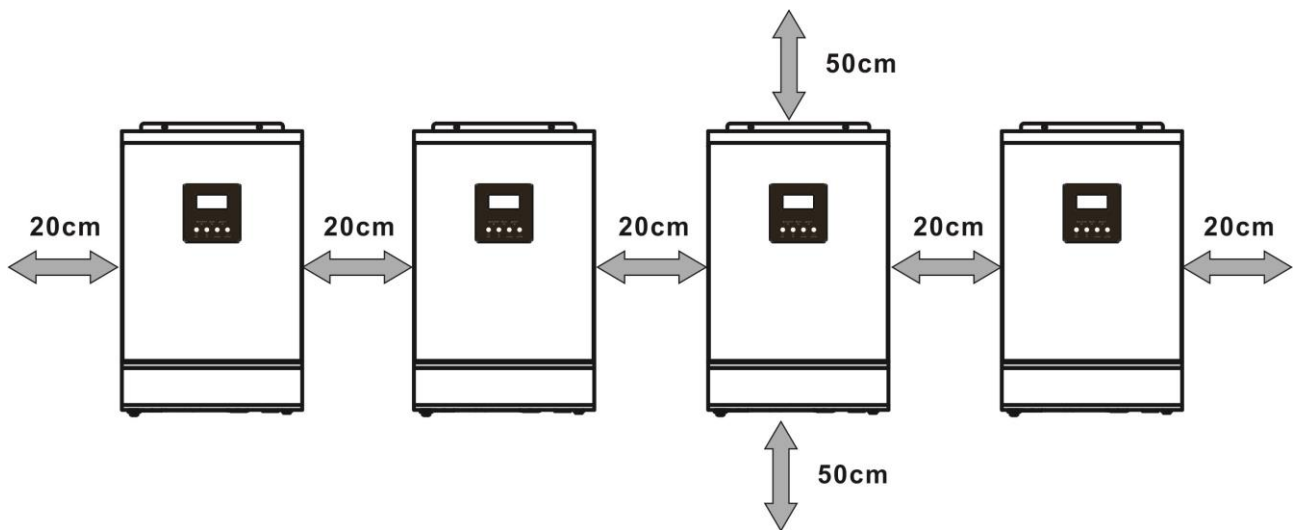

NOTE: For proper air circulation to dissipate heat, allow a clearance of approx. 20 cm to the side and approx. 50 cm above and below the unit. Be sure to install each unit in the same level.

5. Wiring Connection

NOTICE: It's requested to connect to battery for parallel operation.

The cable size of each inverter is shown as below:

Recommended battery cable and terminal size for each inverter:

| Model | Wire Size | Ring Terminal | | Torque value | |
|-------|-----------|-----------------------|------------|--------------|---------|
| | | Cable mm ² | Dimensions | | |
| | | | D (mm) | L (mm) | |
| 2KW | 1*6AWG | 14 | 6.4 | 33.2 | 2~ 3 Nm |
| 3KW | 1*4AWG | 22 | 6.4 | 33.2 | 2~ 3 Nm |
| 5KW | 1*2AWG | 38 | 6.4 | 33.2 | 2~ 3 Nm |

Ring terminal:

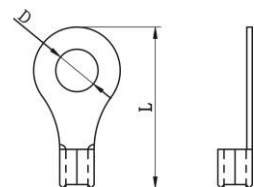

WARNING: Be sure the length of all battery cables is the same. Otherwise, there will be voltage difference between inverter and battery to cause parallel inverters not working.

Recommended AC input and output cable size for each inverter:

| Model | AWG no. | Torque |
|-------|---------|-------------|
| 2KW | 14 AWG | 0.8~ 1.0 Nm |
| 3KW | 12 AWG | 1.2~1.6Nm |
| 5KW | 10 AWG | 1.2~1.6Nm |

You need to connect the cables of each inverter together. Take the battery cables for example: You need to use a connector or bus-bar as a joint to connect the battery cables together, and then connect to the battery terminal. The cable size used from joint to battery should be X times cable size in the tables above. "X" indicates the number of inverters connected in parallel.

Regarding AC input and output, please also follow the same principle.

WARNING!! Make sure all output N wires of each inverter must be connected all the time. Otherwise, it will cause inverter fault in error code #72.

CAUTION!! Please install the breaker at the battery and AC input side. This will ensure the inverter can be securely disconnected during maintenance and fully protected from over current of battery or AC input. The recommended mounted location of the breakers is shown in the figures in 5-1 and 5-2.

Recommended breaker specification of battery for each inverter:

| Model | 1 unit* |
|-------|------------|
| 2KW | 80A/70VDC |
| 3KW | 80A/70VDC |
| 5KW | 125A/70VDC |

*If you want to use only one breaker at the battery side for the whole system, the rating of the breaker should be X times current of 1 unit. "X" indicates the number of inverters connected in parallel.

Recommended breaker specification of AC input with single phase:

| Model | 2 units | 3 units | 4 units | 5 units | 6 units | 7 units | 8 units | 9 units |
|-------|----------------|-----------------|-----------------|-----------------|-----------------|-----------------|-----------------|-----------------|
| 2KW | 80A/ 230VAC | 120A/ 230VAC | 160A/ 230VAC | 200A/ 230VAC | 240A/ 230VAC | 280A/ 230VAC | 320A/ 230VAC | 360A/ 230VAC |
| 3KW | 80A/ 230VAC | 120A/ 230VAC | 160A/ 230VAC | 200A/ 230VAC | 240A/ 230VAC | 280A/ 230VAC | 320A/ 230VAC | 360A/ 230VAC |
| 5KW | 80A/ 230VAC | 120A/ 230VAC | 160A/ 230VAC | 200A/ 230VAC | 240A/ 230VAC | 280A/ 230VAC | 320A/ 230VAC | 360A/ 230VAC |

Note1: Also, you can use 40A breaker for 2KW and 50A for 3KW/5KW for only 1 unit and install one breaker at its AC input in each inverter.

Note2: Regarding three-phase system, you can use 4-pole breaker directly and the rating of the breaker should be compatible with the phase current limitation from the phase with maximum units

Recommended battery capacity

| Inverter parallel numbers | 2 | 3 | 4 | 5 | 6 | 7 | 8 | 9 |
|---------------------------|-------|-------|-------|--------|--------|--------|--------|--------|
| Battery Capacity for 2KW | 200AH | 400AH | 400AH | 600AH | 600AH | 800AH | 800AH | 1000AH |
| Battery Capacity for 3KW | 400AH | 600AH | 800AH | 1000AH | 1200AH | 1400AH | 1600AH | 1800AH |
| Battery Capacity for 5KW | 400AH | 600AH | 800AH | 1000AH | 1200AH | 1400AH | 1600AH | 1800AH |

WARNING! Be sure that all inverters will share the same battery bank. Otherwise, the inverters will transfer to fault mode.

5-1. Parallel Operation in Single phase

Two inverters in parallel:

Power Connection

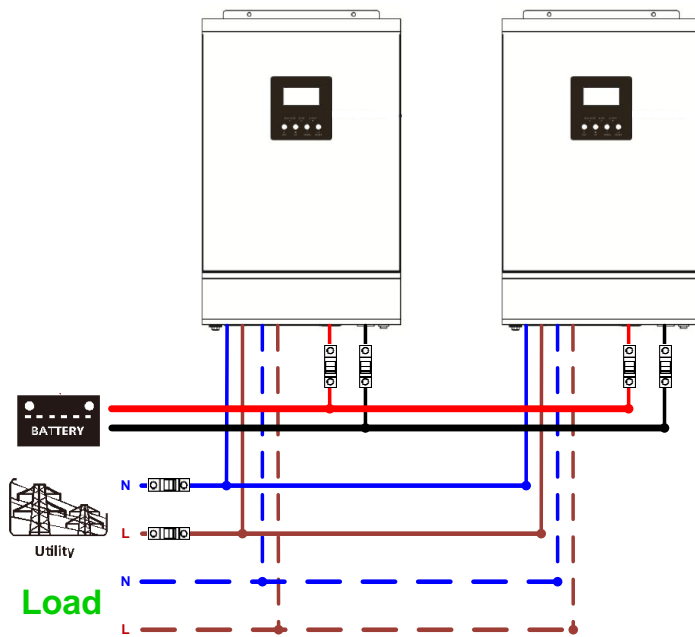

Communication Connection

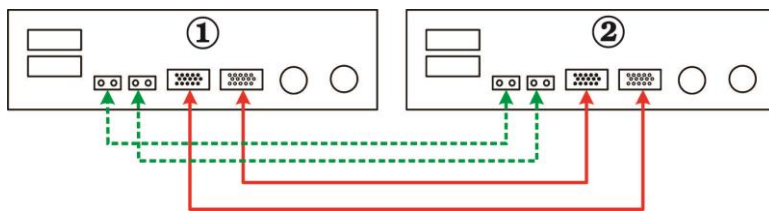

Three inverters in parallel:

Power Connection

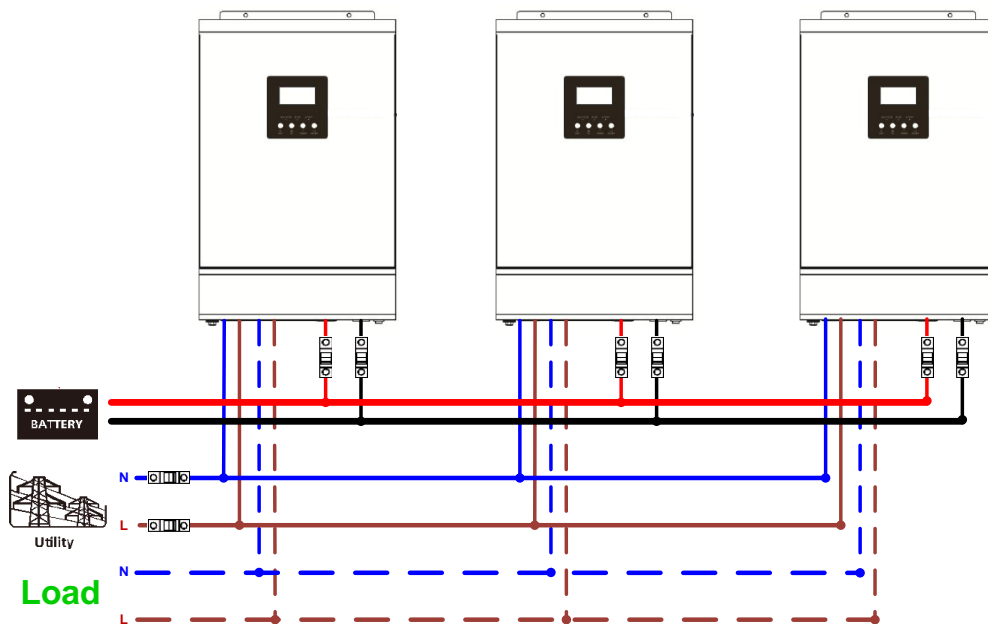

Communication Connection

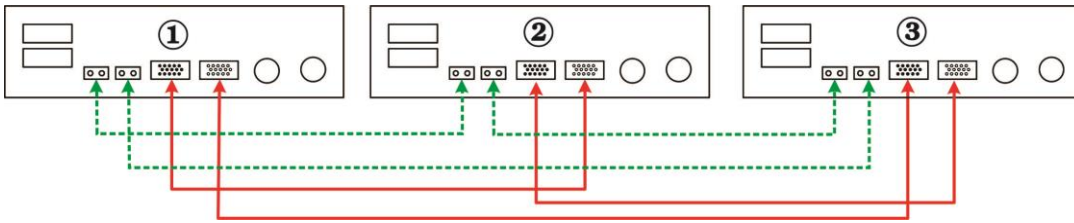

Four inverters in parallel:

Power Connection

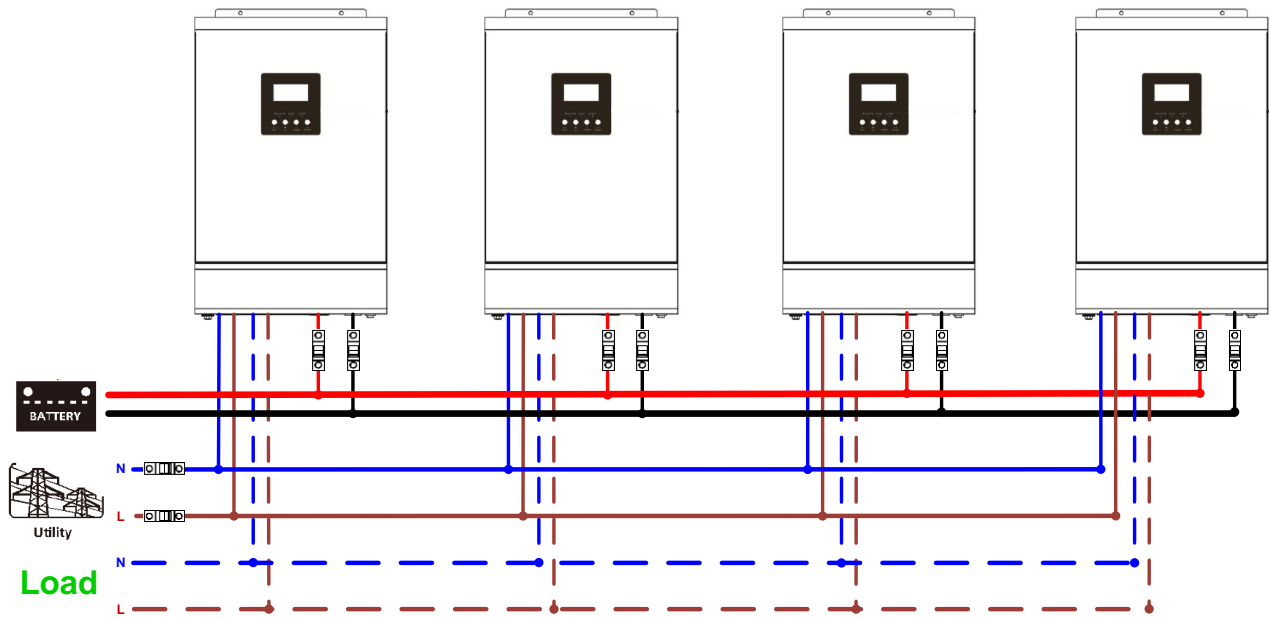

Communication Connection

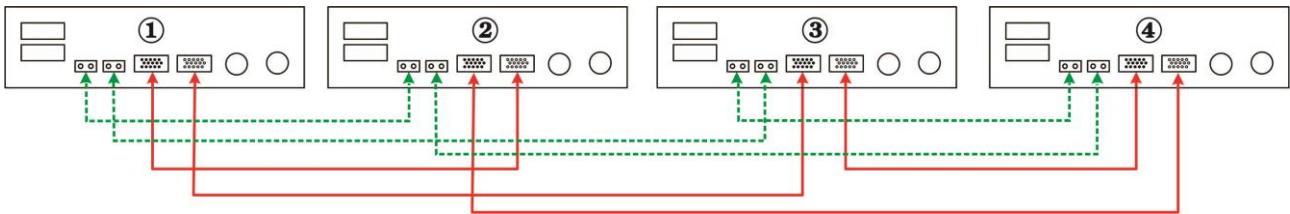

Five inverters in parallel:

Power Connection

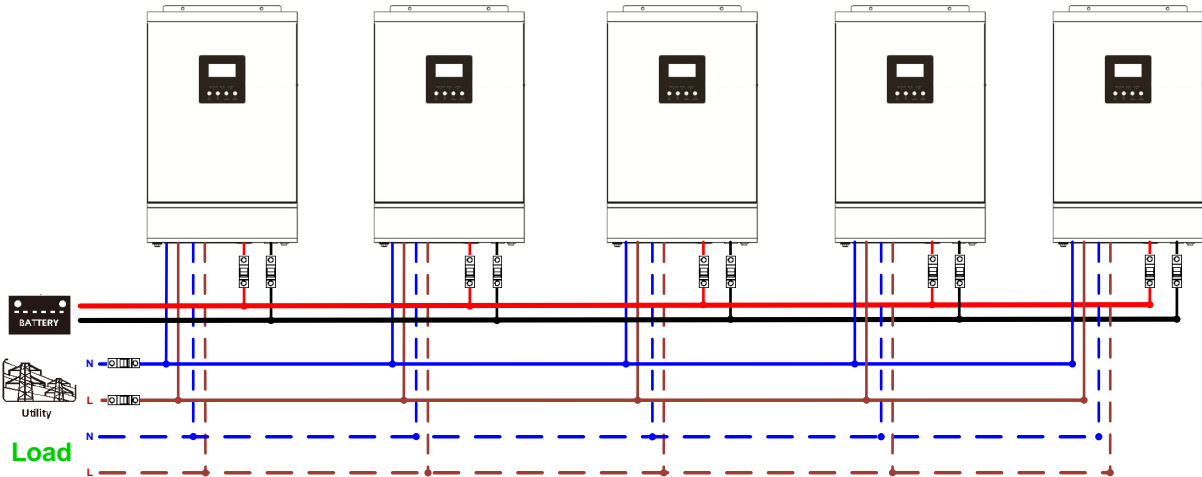

Communication Connection

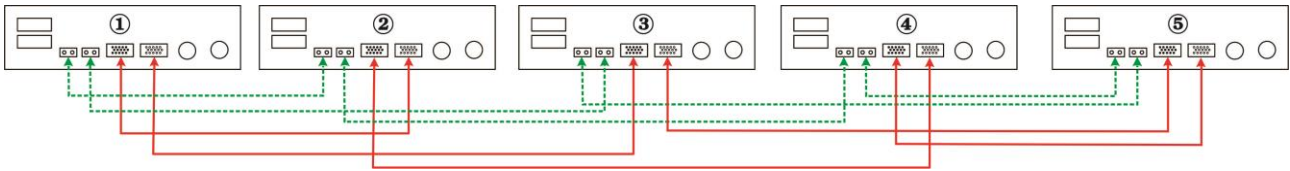

Six inverters in parallel:

Power Connection

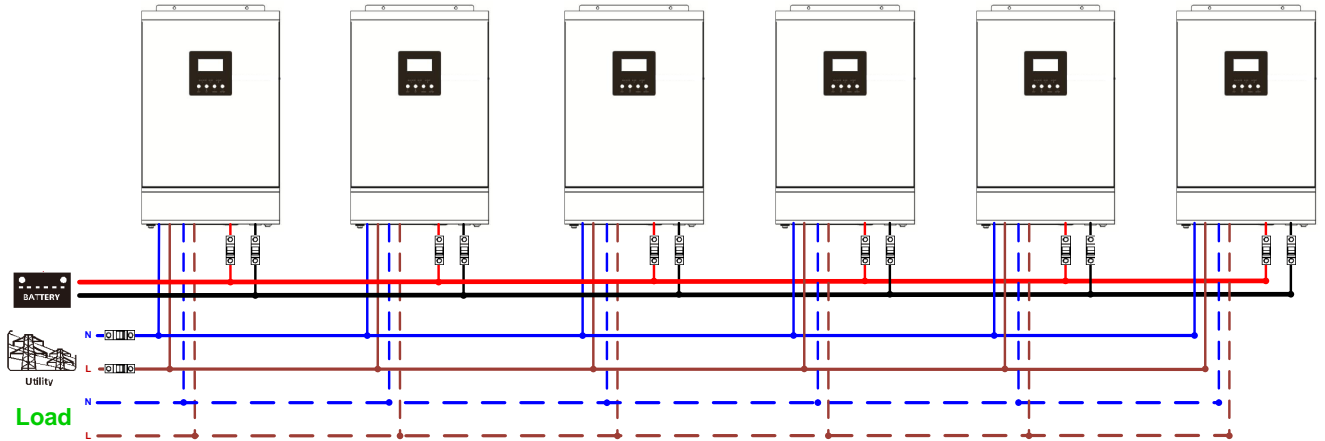

Communication Connection

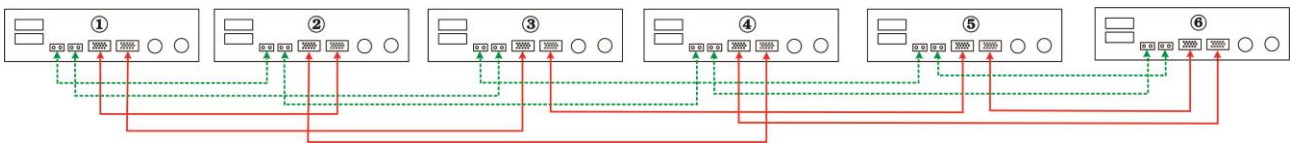

Seven to nine inverters in parallel:

Power Connection

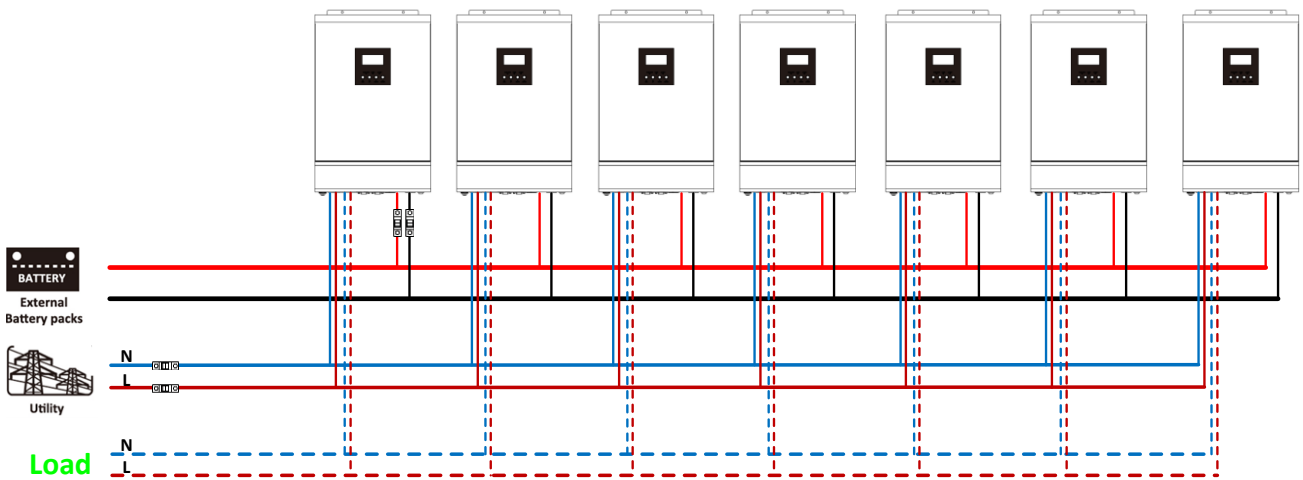

Communication Connection

➤ Seven inverters in parallel

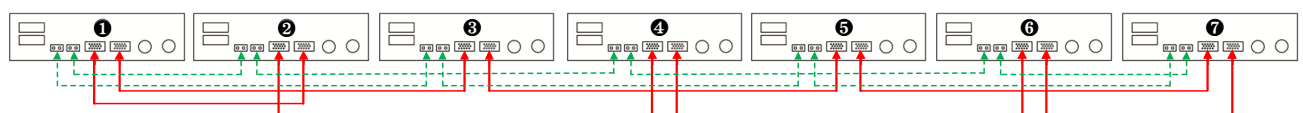

➤ Eight inverters in parallel

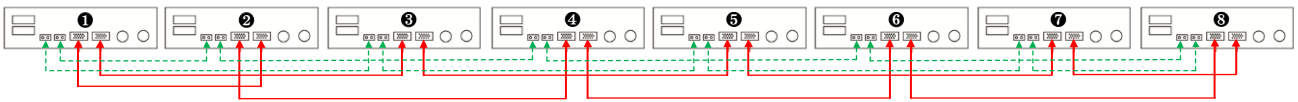

➤ Nine inverters in parallel

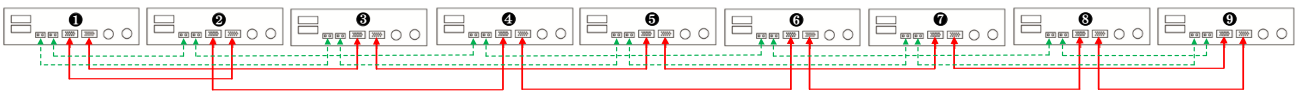

5-2. Support 3-phase equipment

Three inverters in each phase:

Power Connection

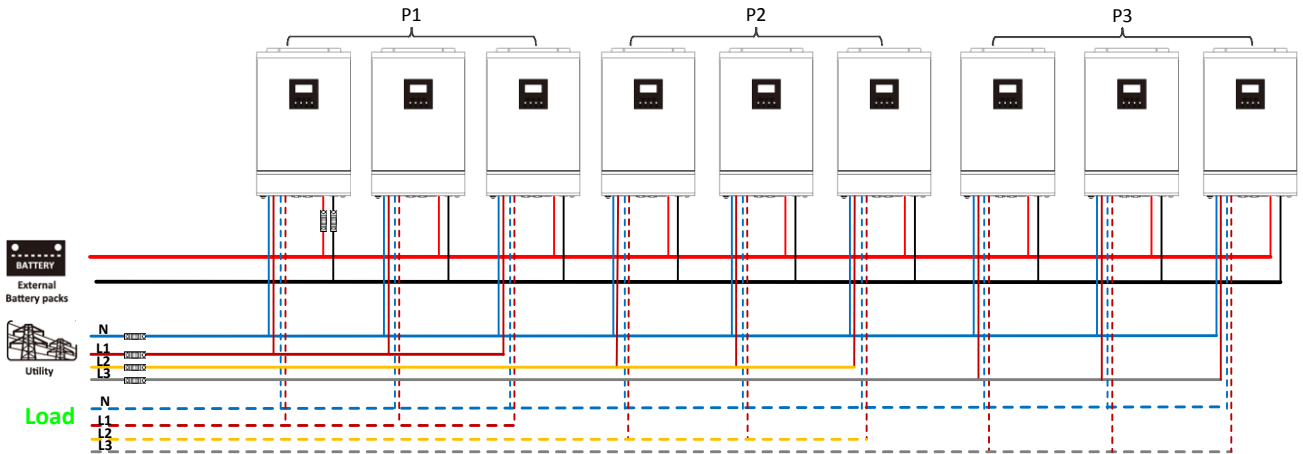

Communication Connection

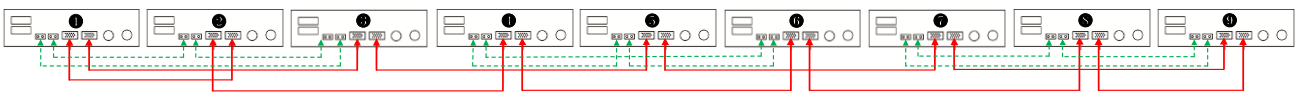

Three inverters in one phase, three inverters in second phase and two inverter for the third phase:

Power Connection

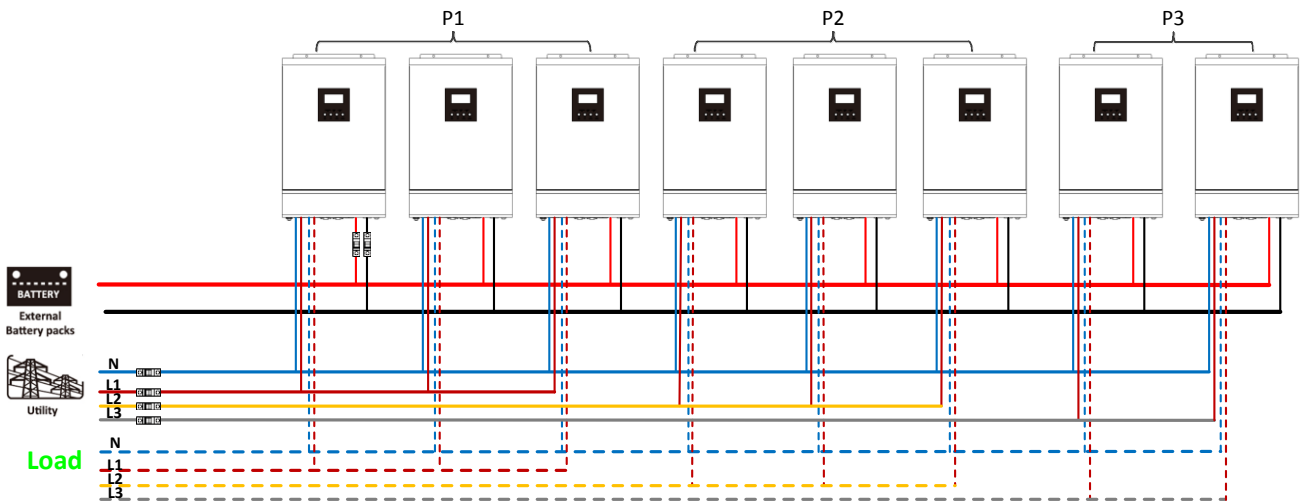

Communication Connection

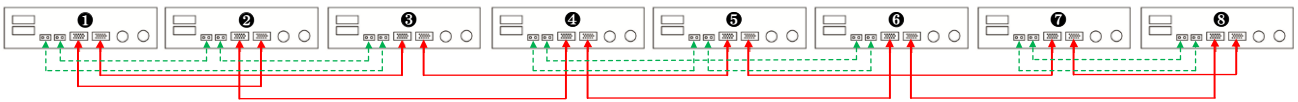

Three inverters in one phase, two inverters in second phase and two inverters for the third phase:

Power Connection

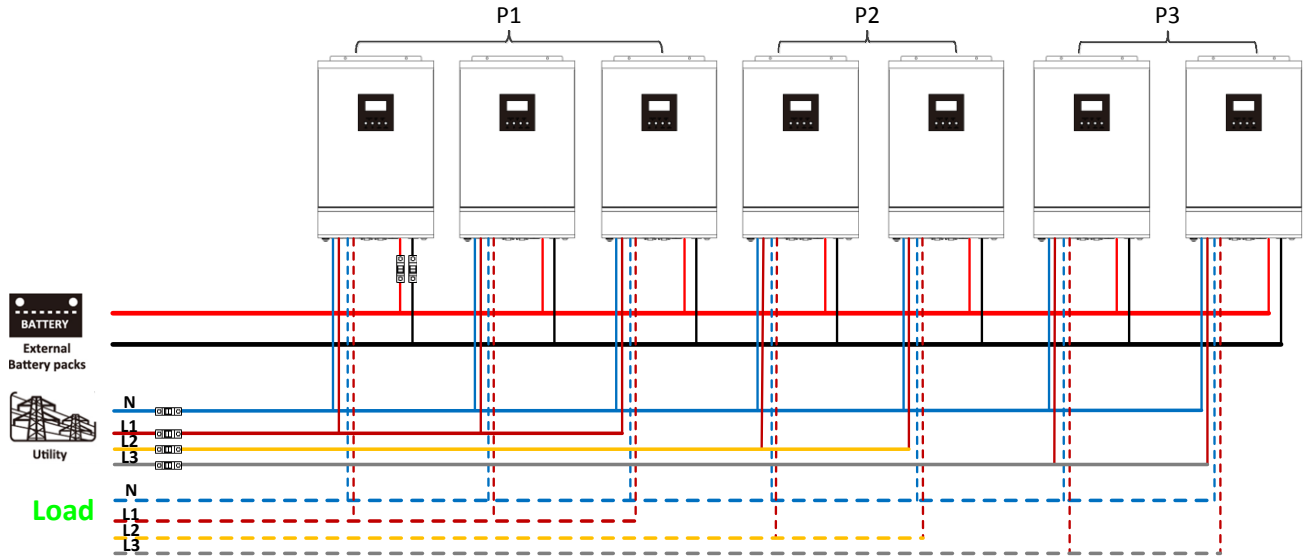

Communication Connection

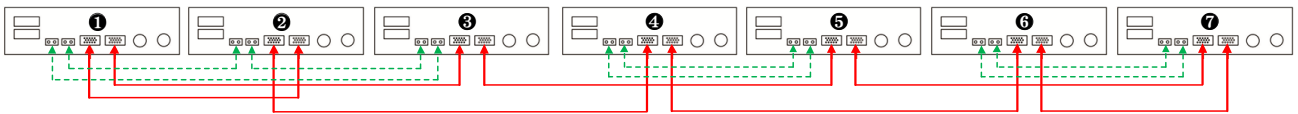

Two inverters in each phase:

Power Connection

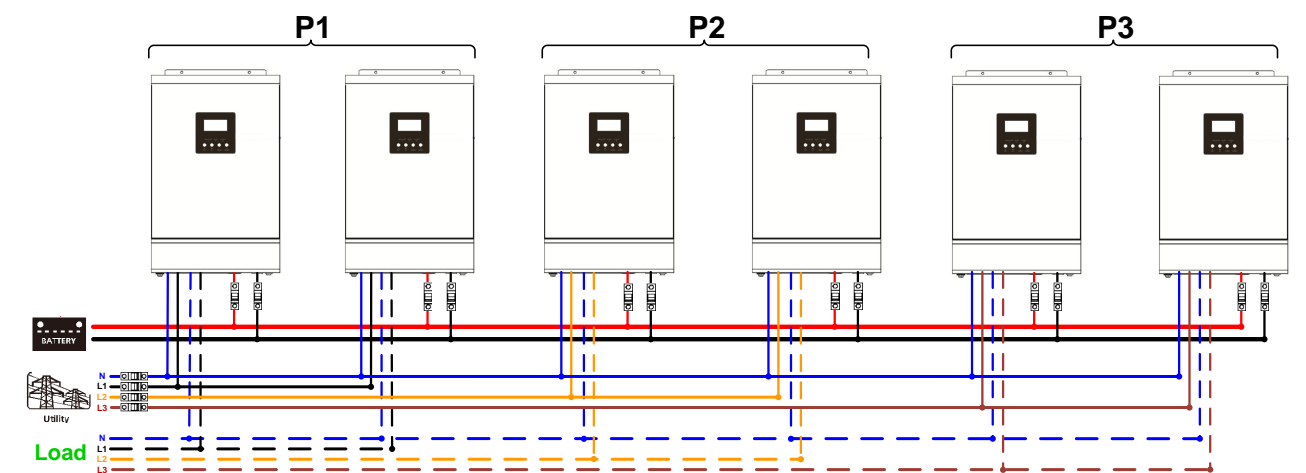

Communication Connection

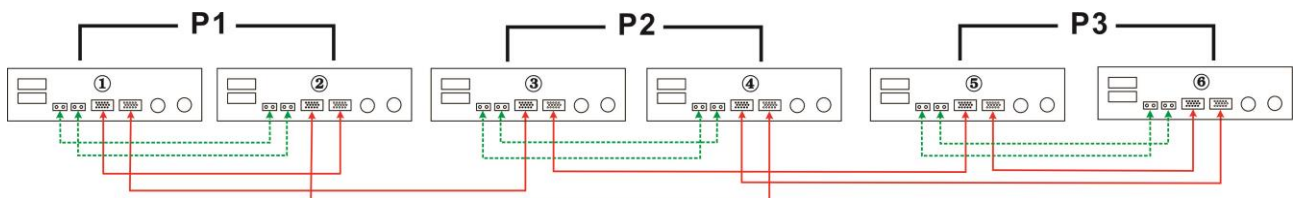

Four inverters in one phase and one inverter for the other two phases:

Power Connection

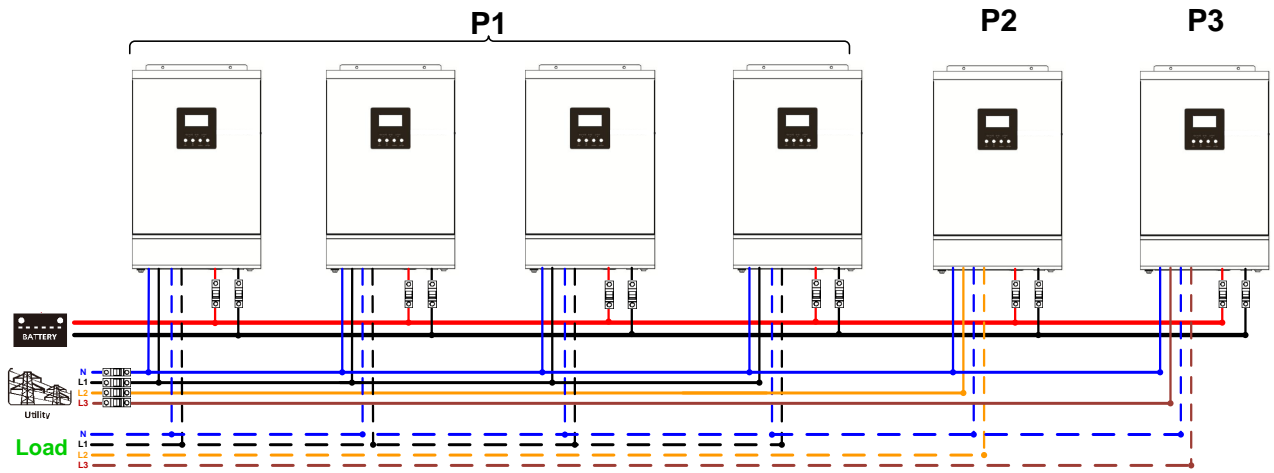

Communication Connection

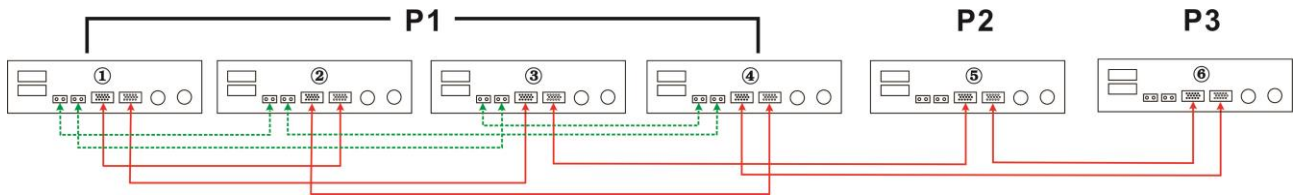

Three inverters in one phase, two inverters in second phase and one inverter for the third phase:

Power Connection

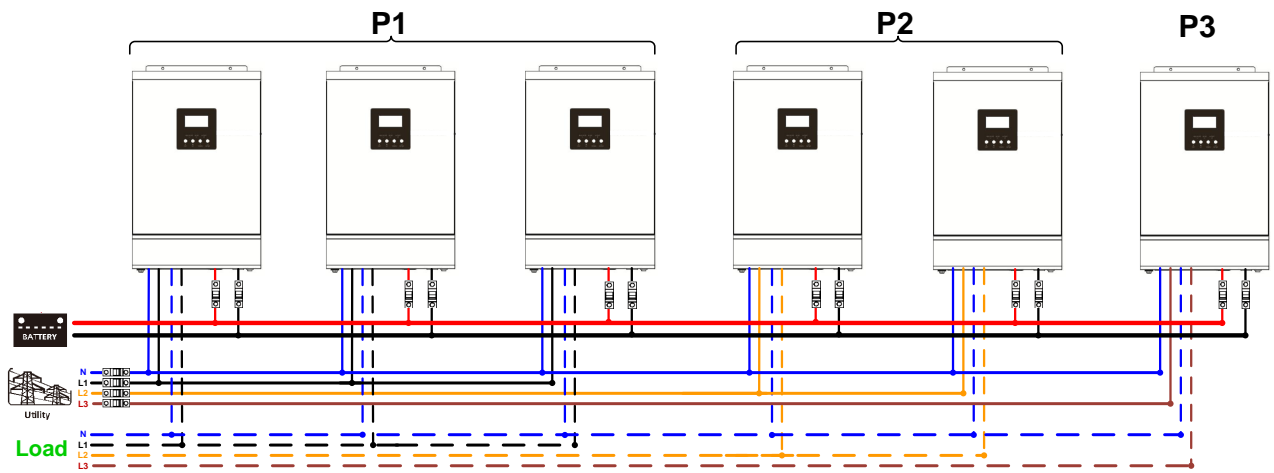

Communication Connection

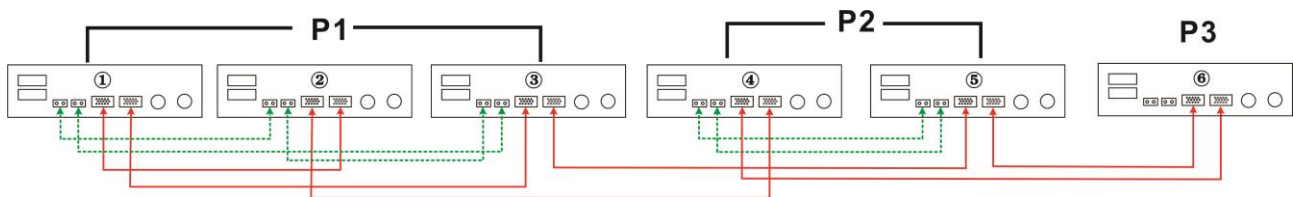

Three inverters in one phase and only one inverter for the remaining two phases:

Power Connection

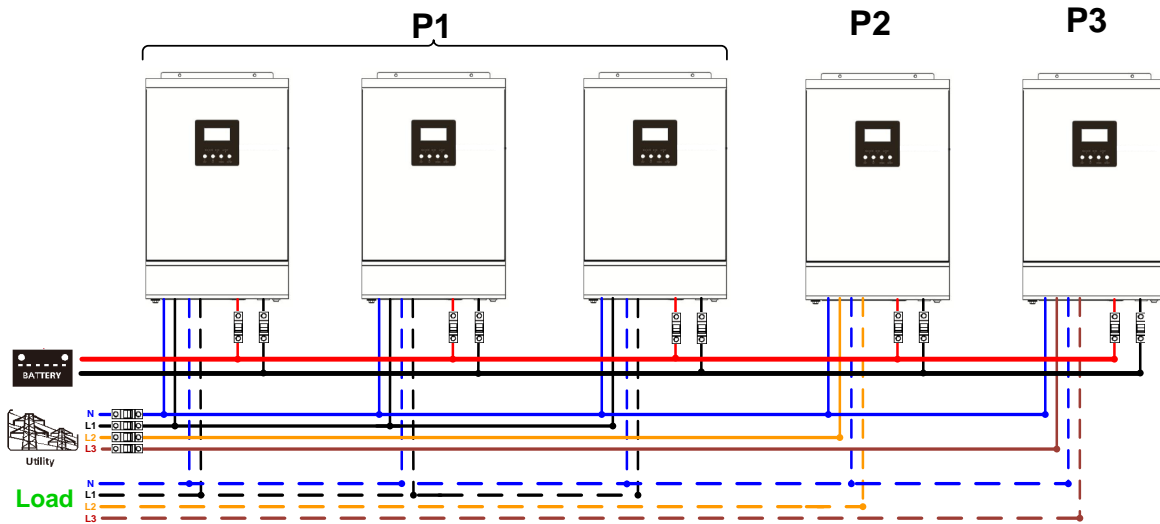

Communication Connection

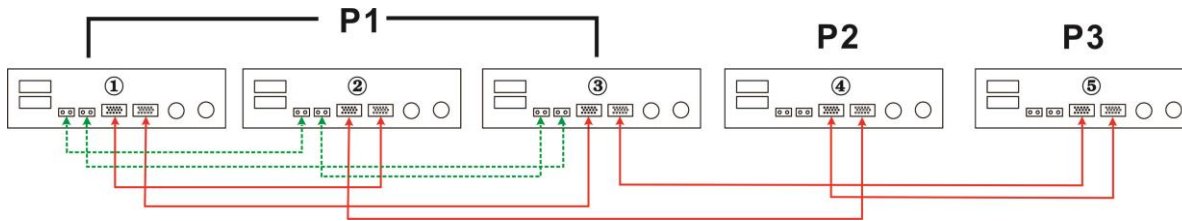

Two inverters in two phases and only one inverter for the remaining phase:

Power Connection

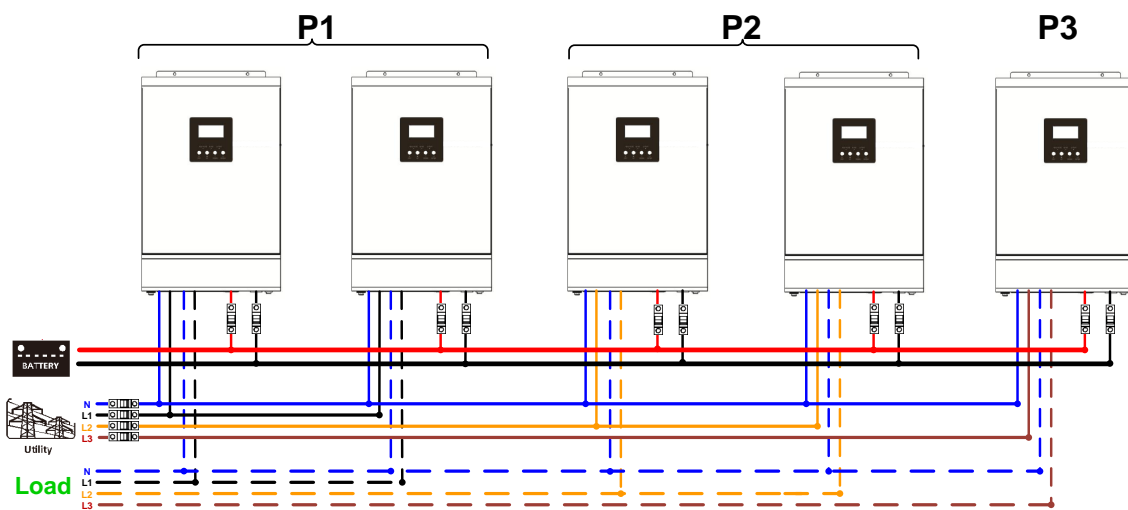

Communication Connection

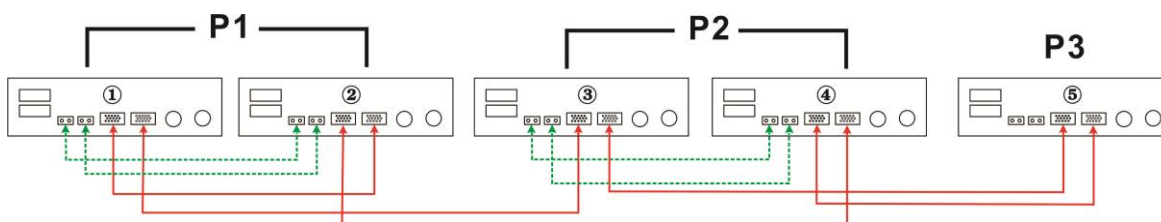

Two inverters in one phase and only one inverter for the remaining phases:

Power Connection

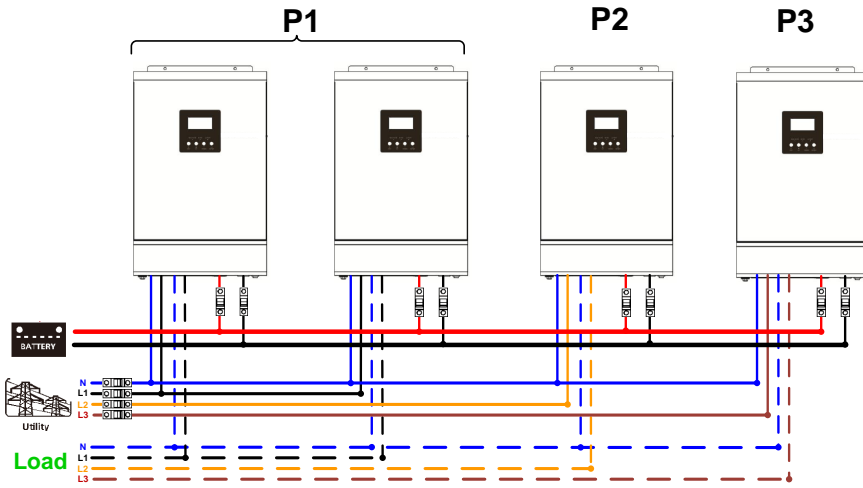

Communication Connection

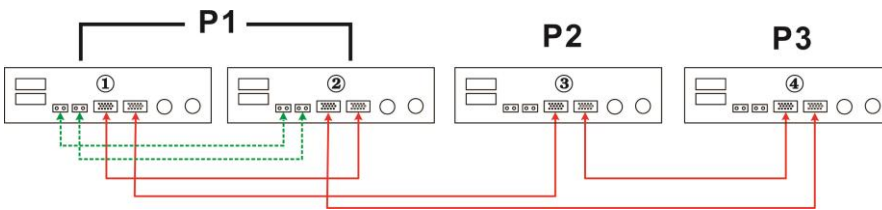

One inverter in each phase:

Power Connection

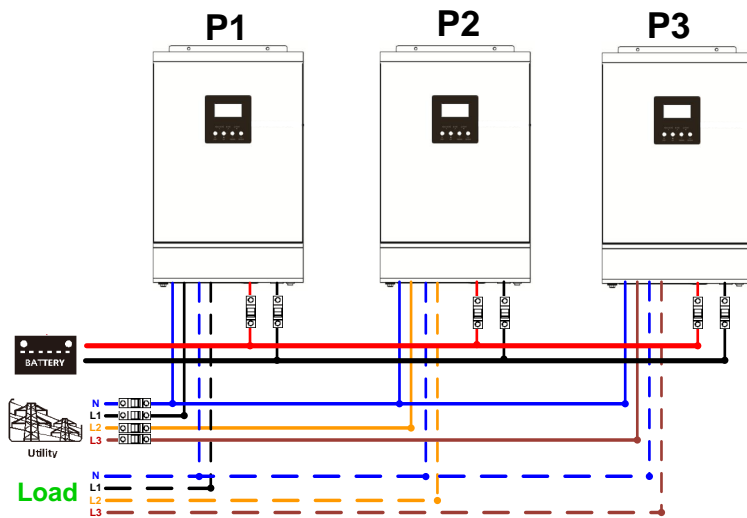

Communication Connection

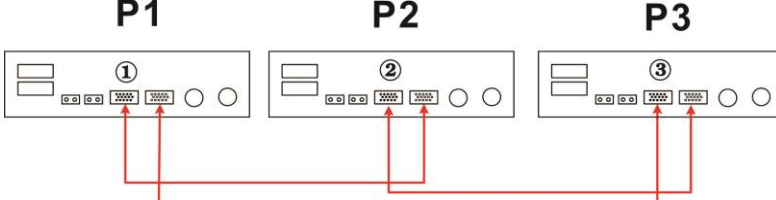

WARNING: Do not connect the current sharing cable between the inverters which are in different phases. Otherwise, it may damage the inverters.

6. PV Connection

Please refer to user manual of single unit for PV Connection.

CAUTION: Each inverter should connect to PV modules separately.

7. LCD Setting and Display

Setting Program:

| Program | Description | Selectable option | |
|---------|--|---|---|
| 28 | AC output mode *This setting is only available when the inverter is in standby mode (Switch off). | Single: 28 ^{OUTPUT} <u>SI G</u> | When the units are used in parallel with single phase, please select "PAL" in program 28. |
| | | Parallel: 28 ^{OUTPUT} <u>PAL</u> | It is required to have at least 3 inverters or maximum 6 inverters to support three-phase equipment. It's required to have at least one inverter in each phase or it's up to four inverters in one phase. Please refers to 5-2 for detailed information. Please select "3P1" in program 28 for the inverters connected to L1 phase, "3P2" in program 28 for the inverters connected to L2 phase and "3P3" in program 28 for the inverters connected to L3 phase. |
| | | L1 phase: 28 ^{OUTPUT} <u>3P 1</u> | |
| | | L2 phase: 28 ^{OUTPUT} <u>3P 2</u> | |
| | | L3 phase: 28 ^{OUTPUT} <u>3P 3</u> | Be sure to connect share current cable to units which are on the same phase. Do NOT connect share current cable between units on different phases. |
| | | | Besides, power saving function will be automatically disabled. |
| 30 | PV judge condition (Only apply for setting "Solar first" in program 1: Output source priority) | One Inverter (Default): 30 <u>ONE</u> | When "ONE" is selected, as long as one of inverters has been connected to PV modules and PV input is normal, parallel or 3-phase system will continue working according to rule of "solar first" setting. For example, two units are connected in parallel and set "SOL" in output source priority. If one of two units has connected to PV modules and PV input is normal, the parallel system will provide power to loads from solar or battery power. If both of them are not sufficient, the system will provide power to loads from utility. |
| | | All of Inverters: 30 <u>ALL</u> | When "ALL" is selected, parallel or 3-phase system will continue working according to rule of "solar first" setting only when all of inverters are connected to PV modules. For example, two units are connected in parallel and set "SOL" in output source priority. When selecting "ALL" in program 30, it's necessary to have all inverters connected to PV modules and PV input is normal to allow the system to provide power to loads from solar and battery power. Otherwise, the system will provide power to loads from utility. |

Fault code display:

| Fault Code | Fault Event | Icon on |
|------------|---|---------|
| 60 | Power feedback protection | |
| 71 | Firmware version inconsistent | |
| 72 | Current sharing fault | |
| 80 | CAN fault | |
| 81 | Host loss | |
| 82 | Synchronization loss | |
| 83 | Battery voltage detected different | |
| 84 | AC input voltage and frequency detected different | |
| 85 | AC output current unbalance | |
| 86 | AC output mode setting is different | |

8. Commissioning

Parallel in single phase

Step 1: Check the following requirements before commissioning:

- Correct wire connection
- Ensure all breakers in Line wires of load side are open and each Neutral wires of each unit are connected together.

Step 2: Turn on each unit and set "PAL" in LCD setting program 28 of each unit. And then shut down all units.

NOET: It's necessary to turn off switch when setting LCD program. Otherwise, the setting can not be programmed.

Step 3: Turn on each unit.

| LCD display in Master unit | LCD display in Slave unit |
|----------------------------|---------------------------|
| | |

NOTE: Master and slave units are randomly defined.

Step 4: Switch on all AC breakers of Line wires in AC input. It's better to have all inverters connect to utility at the same time. If not, it will display fault 82 in following-order inverters. However, these inverters will automatically restart. If detecting AC connection, they will work normally.

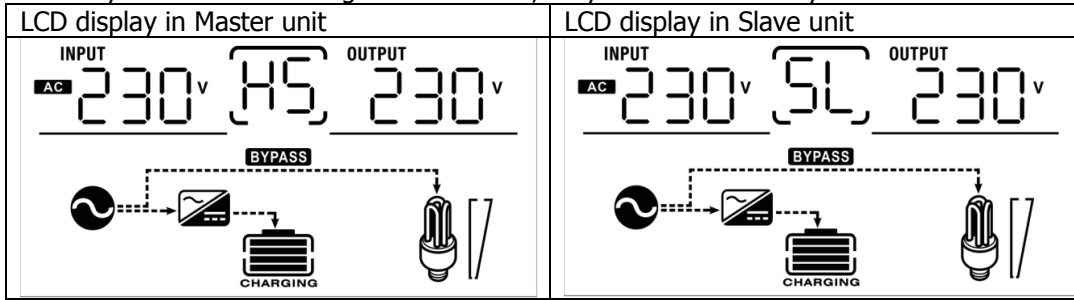

Step 5: If there is no more fault alarm, the parallel system is completely installed.

Step 6: Please switch on all breakers of Line wires in load side. This system will start to provide power to the load.

Support three-phase equipment

Step 1: Check the following requirements before commissioning:

- Correct wire connection
- Ensure all breakers in Line wires of load side are open and each Neutral wires of each unit are connected together.

Step 2: Turn on all units and configure LCD program 28 as P1, P2 and P3 sequentially. And then shut down all units.

NOET: It's necessary to turn off switch when setting LCD program. Otherwise, the setting can not be programmed.

Step 3: Turn on all units sequentially.

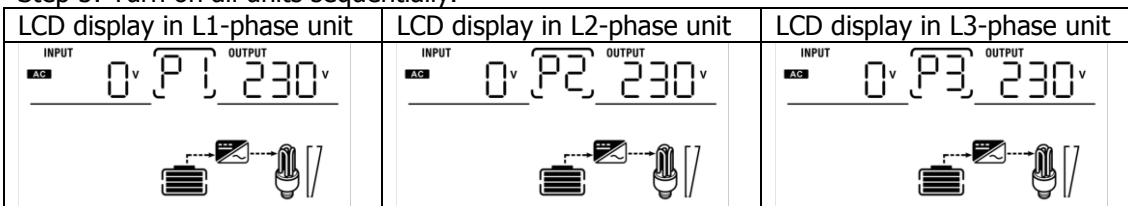

Step 4: Switch on all AC breakers of Line wires in AC input. If AC connection is detected and three phases are matched with unit setting, they will work normally. Otherwise, the AC icon will flash and they will not work in line mode.

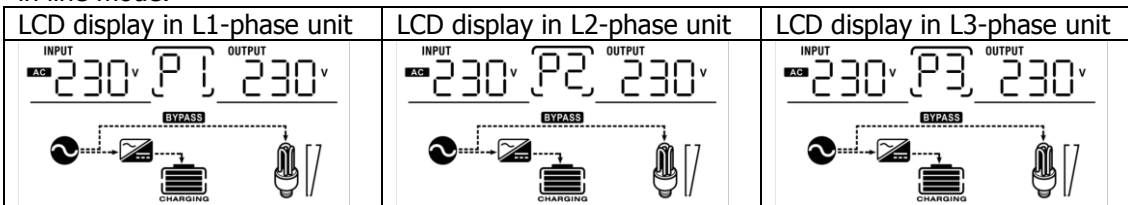

Step 5: If there is no more fault alarm, the system to support 3-phase equipment is completely installed.

Step 6: Please switch on all breakers of Line wires in load side. This system will start to provide power to the load.

Note 1: To avoid overload occurring, before turning on breakers in load side, it's better to have whole system in operation first.

Note 2: Transfer time for this operation exists. Power interruption may happen to critical devices, which cannot bear transfer time.

9. Trouble shooting

| Situation | | Solution |
|------------|--|--|
| Fault Code | Fault Event Description | |
| 60 | Current feedback into the inverter is detected. | <ol style="list-style-type: none"> Restart the inverter. Check if L/N cables are not connected reversely in all inverters. For parallel system in single phase, make sure the sharing are connected in all inverters. For supporting three-phase system, make sure the sharing cables are connected in the inverters in the same phase, and disconnected in the inverters in different phases. If the problem remains, please contact your installer. |
| 71 | The firmware version of each inverter is not the same. | <ol style="list-style-type: none"> Update all inverter firmware to the same version. Check the version of each inverter via LCD setting and make sure the CPU versions are same. If not, please contact your instraller to provide the firmware to update. After updating, if the problem still remains, please contact your installer. |
| 72 | The output current of each inverter is different. | <ol style="list-style-type: none"> Check if sharing cables are connected well and restart the inverter. If the problem remains, please contact your installer. |
| 80 | CAN data loss | <ol style="list-style-type: none"> Check if communication cables are connected well and restart the inverter. If the problem remains, please contact your installer. |
| 81 | Host data loss | |
| 82 | Synchronization data loss | |
| 83 | The battery voltage of each inverter is not the same. | <ol style="list-style-type: none"> Make sure all inverters share same groups of batteries together. Remove all loads and disconnect AC input and PV input. Then, check battery voltage of all inverters. If the values from all inverters are close, please check if all battery cables are the same length and same material type. Otherwise, please contact your installer to provide SOP to calibrate battery voltage of each inverter. If the problem still remains, please contact your installer. |
| 84 | AC input voltage and frequency are detected different. | <ol style="list-style-type: none"> Check the utility wiring connction and restart the inverter. Make sure utility starts up at same time. If there are breakers installed between utility and inverters, please be sure all breakers can be turned on AC input at same time. If the problem remains, please contact your installer. |
| 85 | AC output current unbalance | <ol style="list-style-type: none"> Restart the inverter. Remove some excessive loads and re-check load information from LCD of inverters. If the values are different, please check if AC input and output cables are in the same length and material type. If the problem remains, please contact your installer. |
| 86 | AC output mode setting is different. | <ol style="list-style-type: none"> Switch off the inverter and check LCD setting #28. For parallel system in single phase, make sure no 3P1, 3P2 or 3P3 is set on #28. For upporting three-phase system, make sure no "PAL" is set on #28. If the problem remains, please contact your installer. |

Appendix II: Approximate Back-up Time Table

| Model | Load (VA) | Backup Time @ 48Vdc 100Ah (min) | Backup Time @ 48Vdc 200Ah (min) |
|---------|-----------|---------------------------------|---------------------------------|
| 2KW | 200 | 1581 | 3161 |
| | 400 | 751 | 1581 |
| | 600 | 491 | 1054 |
| | 800 | 331 | 760 |
| | 1000 | 268 | 615 |
| | 1200 | 221 | 508 |
| | 1400 | 172 | 387 |
| | 1600 | 136 | 335 |
| | 1800 | 120 | 295 |
| | 2000 | 106 | 257 |
| 3KW/5KW | 300 | 1054 | 2107 |
| | 600 | 491 | 1054 |
| | 900 | 291 | 688 |
| | 1200 | 196 | 497 |
| | 1500 | 159 | 402 |
| | 1800 | 123 | 301 |
| | 2100 | 105 | 253 |
| | 2400 | 91 | 219 |
| | 2700 | 71 | 174 |
| | 3000 | 63 | 155 |

Note: Backup time depends on the quality of the battery, age of battery and type of battery.
Specifications of batteries may vary depending on different manufacturers.