

Description

LPM A3 series pressure switch opens or closes its electrical circuit depending on pressure rises or drops. Working pressure can be set from 7 bar to 600 bar by hand wheel on pressure switch. Pressure value can be followed instantly thanks to manometer which is on the pressure switch. It has been designed suitable for using under high and shock pressures. It makes itself interesting for costumers thanks to easy adjustability and sensitivity.

- LPM A3 series pressure switch can be set thanks to hand wheel on pressure switch
- Desired pressure can be set easily thanks to pressure set scale.
- It has Aluminium body material
- NBR and Teflon seal equipments.
- It has feature to work under high vibration.
- It is connected to pressure line with G1/4" gland connection
- Pressure can be followed instantly thanks to manometer

Applications

- Hydraulic and mobile hydraulics
- Pneumatics
- Heavy-Duty machines industry
- Media; Compressed air, liquids, gases.

Technical Features

Connection Type	: G1/4" gland connection
Reproducibility	: Within %1 of set pressure
Working Temperature	: -20°C...+110°C
Vibration Test (DIN EN 60068-2-6:1996)	: 20 g (Test Time 30 min.)
Shock Test (DIN EN 60068-2-27:1993)	: 30 g
Working Cycle	: 5 000 000 cycle
Viscosity Range	: Between 10 ... 800 mm ² /sn
Electrical Features	: 5A 250VAC

Notes

These values are maximum values and they can not be used at the same time. When you need to use the pressure switch in aggressive chemicals or fluids please contact with us. You must stict to rules of clearence standarts Hydraulic oils (fluids). Use filtration to blocking system errors. It is effective for long working life of pressure switches. Please avoid using out of indicated values to have a long service from pressure switch.



Order Codes

PRODUCT	PRODUCT CODE	PRESSURE RANGE	MANOMETER	ELECTRICAL CONNECTION TYPE	CONNECTION TYPE
LPM A3	LPM A3 070	7 ... 70 bar	Ø63 - 100 bar	NA / NC	G1/4" GLAND CONNECTION
	LPM A3 160	10 ... 160 bar	Ø63 - 250 bar		
	LPM A3 300	20 ... 300 bar	Ø63 - 400 bar		
	LPM A3 400	20 ... 400 bar	Ø63 - 600 bar		
	LPM A3 600	50 ... 600 bar	Ø63 - 600 bar		

Electrical Connection

Contact Connection Scheme

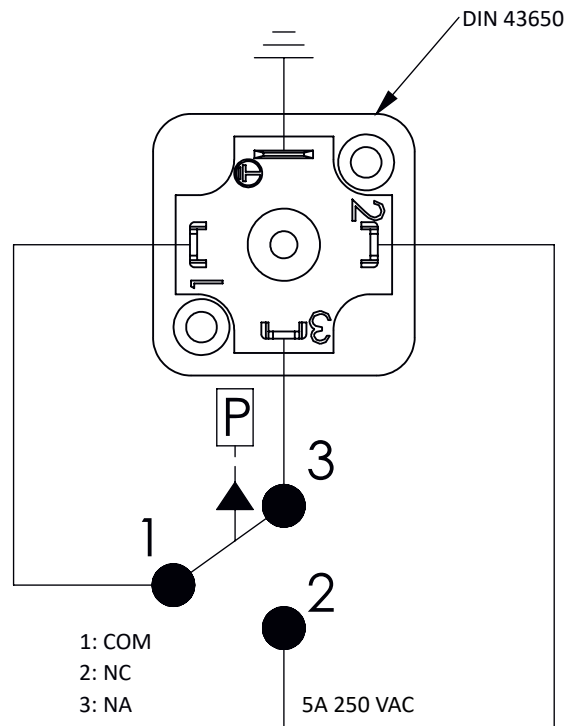

Switch Function

- Terminal 1 - 3 :It has current in case of pressure increasing. (NA)
- Terminal 1 - 2 :It has current in case of pressure decreasing or no pressure. (NC)

Pressure Differential Difference Graphics

Pressure Set Range
7 ... 70 bar
max set pressure 70 bar max system pressure 100 bar

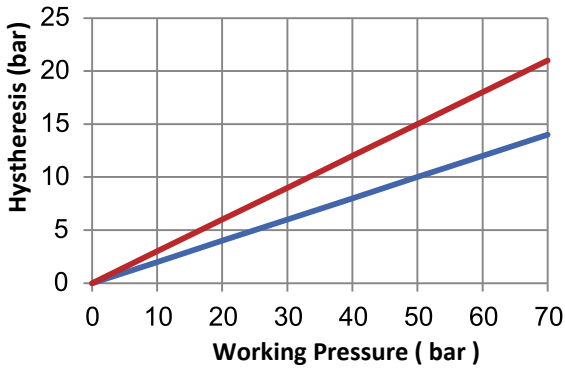

Pressure Set Range
10 ... 160 bar
max set pressure 160 bar max system pressure 250 bar

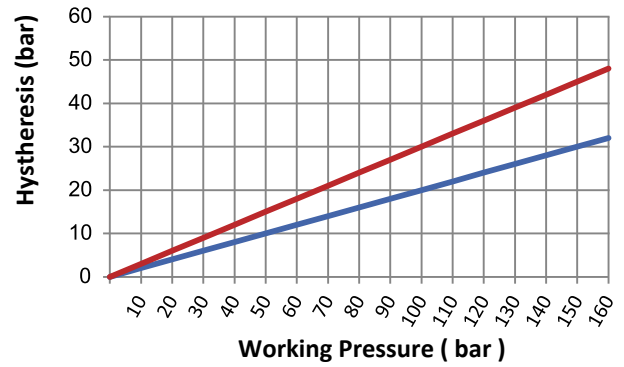

Pressure Set Range
20 ... 300 bar
max set pressure 300 bar max system pressure 400 bar

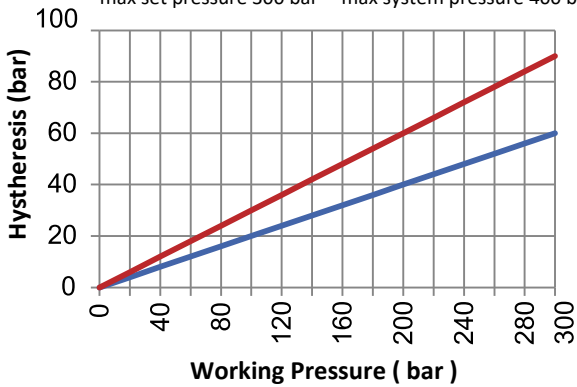

Pressure Set Range
20 ... 400 bar
max set pressure 400 bar max system pressure 600 bar

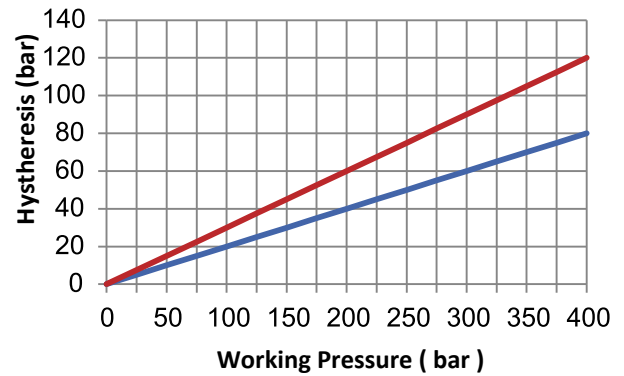

Pressure Set Range
50 ... 600 bar
max set pressure 600 bar max system pressure 600 bar

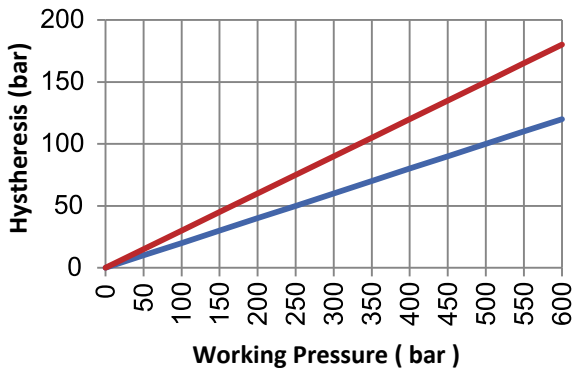

Technical Dimensions

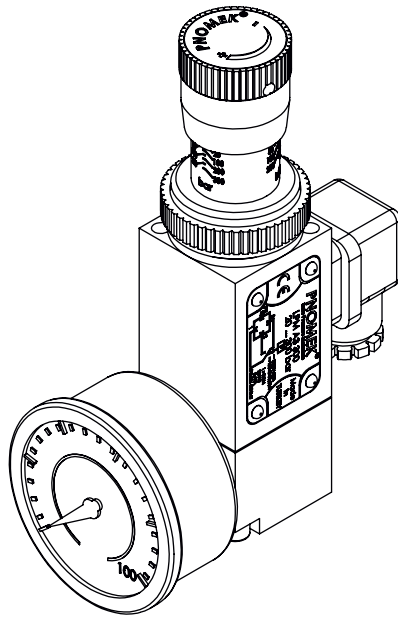
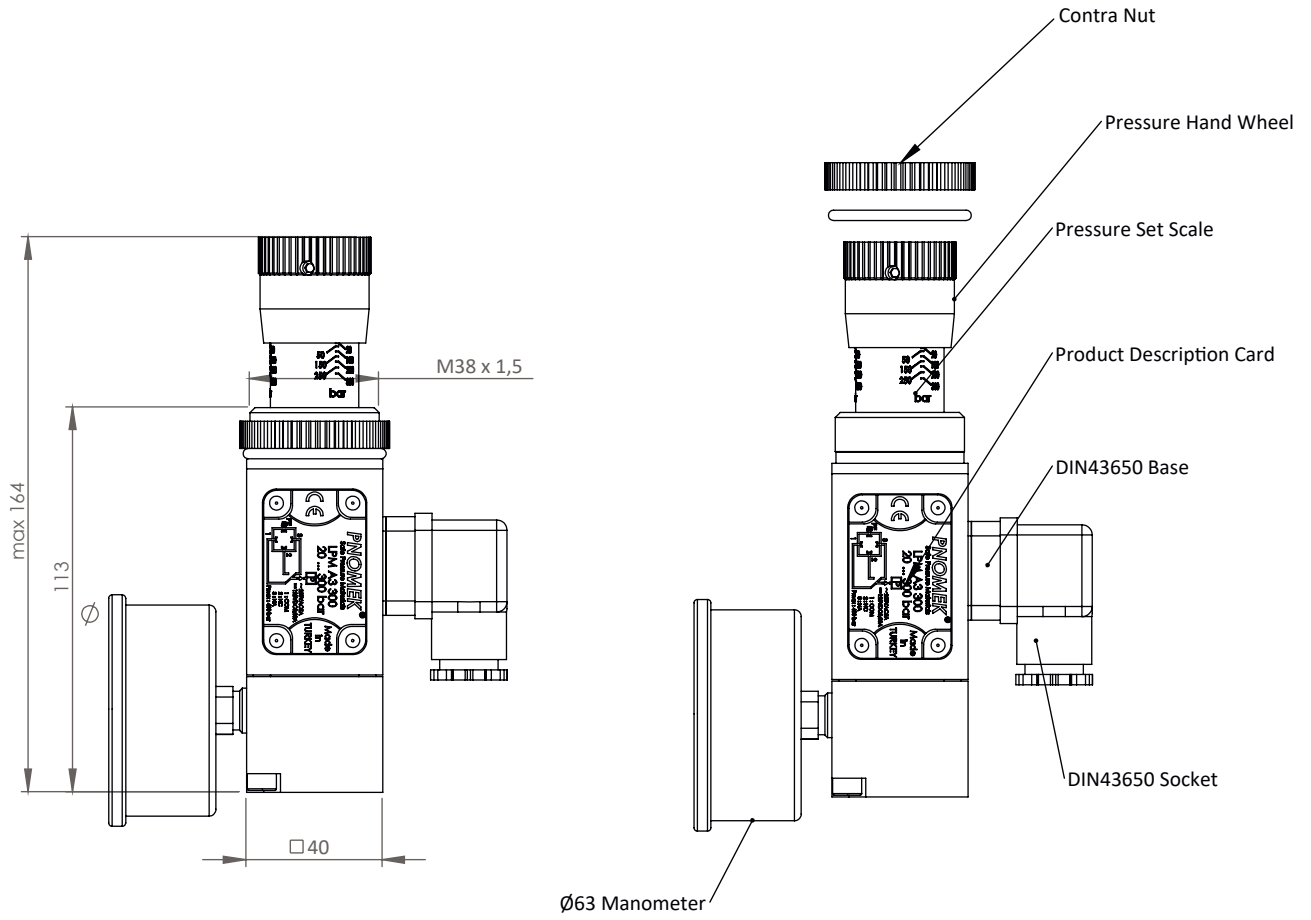

PNOMEK

Safe pressure materials..

PNOMEK Hid. Pno. Mak. Kont. Cihazları San. Tic. Ltd. Şti
Çalı Sanayi Bölgesi, Kırmızı Cd. No:16 Nilüfer-BURSA / TÜRKİYE
pnomek@pnomek.com.tr
T.: +90 (224) 251 63 45
F.: +90 (224) 251 63 46